

TOSHIBA PhotoInterrupter Infrared LED + Phototransistor

TLP831(F)

Lead(Pb)-Free

Home Electronics Equipment Such As
VCRS And CD PlayersOA Equipment Such As Copiers,
Printers, And Facsimiles

Automatic Servicing Equipment

Various Position Detection Sensor

The TLP831(F) photointerrupter consists of a high radiant power GaAs infrared LED and a Si phototransistor.
Housed in a short lead package, this device is ideal for automatic mounting.

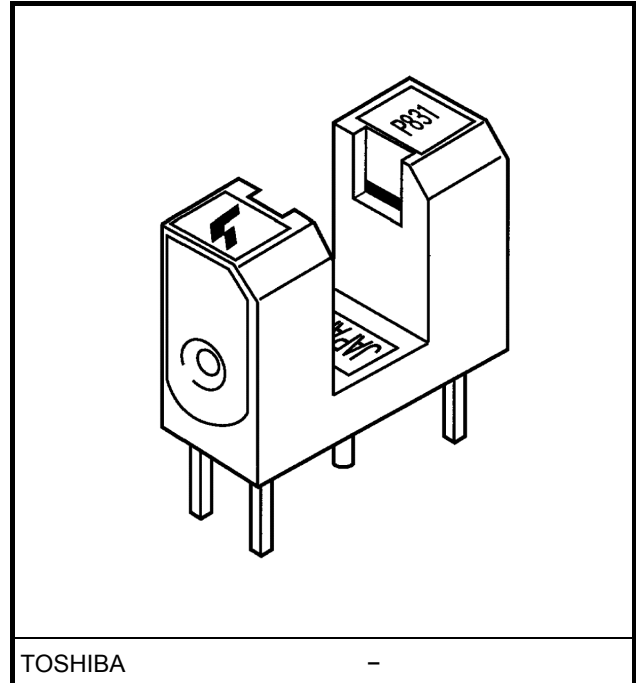

Weight: 0.58 g (typ.)

- Printed wiring board direct mounting type (with a locating pin)
- Short lead type enabling automatic mounting
: Lead length $3.4 \pm 0.3\text{mm}$
- Board thickness: 1.6mm or less
- Gap: 4.2mm
- Resolution: Slit width 0.5mm
- High current transfer ratio: $I_C / I_F = 5\%$ (min)
- High response speed: $t_r, t_f = 15\mu\text{s}$ (typ.)
- Detector side is of visible light cut type.
- Material of the package
: Polybutylene terephthalate (UL94V-0, black color)

Absolute Maximum Ratings (Ta = 25°C)

Characteristic		Symbol	Rating	Unit
LED	Forward current	I_F	50	mA
	Forward current derating (Ta > 25°C)	$\Delta I_F / ^\circ\text{C}$	-0.33	mA / °C
	Reverse voltage	V_R	5	V
Detector	Collector-emitter voltage	V_{CEO}	35	V
	Emitter-collector voltage	V_{ECO}	5	V
	Collector power dissipation	P_C	75	mW
	Collector power dissipation derating (Ta > 25°C)	$\Delta P_C / ^\circ\text{C}$	-1	mW / °C
	Collector current	I_C	50	mA
Operating temperature		T_{opr}	-30~85	°C
Storage temperature		T_{stg}	-40~100	°C
Soldering temperature (5 s) (Note 1)		T_{sol}	260	°C

Note: Using continuously under heavy loads (e.g. the application of high temperature/current/voltage and the significant change in temperature, etc.) may cause this product to decrease in the reliability significantly even if the operating conditions (i.e. operating temperature/current/voltage, etc.) are within the absolute maximum ratings and the operating ranges.

Please design the appropriate reliability upon reviewing the Toshiba Semiconductor Reliability Handbook ("Handling Precautions"/"Derating Concept and Methods") and individual reliability data (i.e. reliability test report and estimated failure rate, etc).

Note 1: At the location of 1.5mm from the resin package bottom

Product Indication

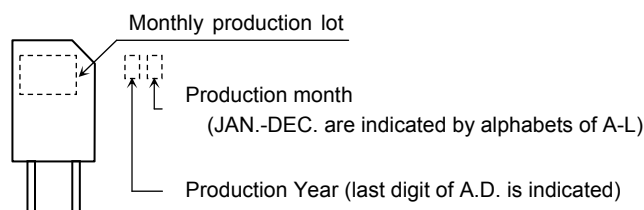

Operating Ranges

Characteristic	Symbol	Min.	Typ.	Max.	Unit
Supply voltage	V_{CC}	—	5	24	V
Forward current	I_F	—	—	25	mA
Operating temperature	T_{opr}	-10	—	75	°C

Opto Electrical Characteristics (Ta = 25°C)

Characteristic		Symbol	Test Condition	Min.	Typ.	Max.	Unit
LED	Forward voltage	V_F	$I_F = 10\text{mA}$	1.00	1.15	1.30	V
	Reverse current	I_R	$V_R = 5\text{V}$	—	—	10	μA
	Peak emission wavelength	λ_P	$I_F = 10\text{mA}$	—	940	—	nm
Detector	Dark current	$I_D (I_{CEO})$	$V_{CE} = 24\text{V}, I_F = 0$	—	—	0.1	μA
	Peak sensitivity wavelength	λ_P		—	870	—	nm
Coupled	Current transfer ratio	I_C / I_F	$V_{CE} = 2\text{V}, I_F = 10\text{mA}$	5	—	100	%
	Collector-emitter saturation voltage	$V_{CE(sat)}$	$I_F = 20\text{mA}, I_C = 0.5\text{mA}$	—	0.1	0.35	V
	Rise time	t_r	$V_{CC} = 5\text{V}, I_C = 1\text{mA}$ $R_L = 1\text{k}\Omega$ (Note 2)	—	15	50	μs
	Fall time	t_f		—	15	50	

Note 2: Switching time measurement circuit and waveform

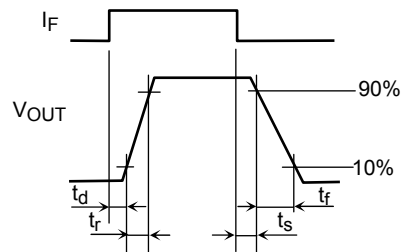
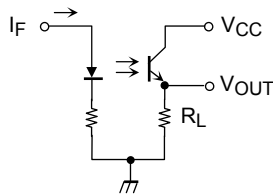

Precautions

- When removing flux with chemicals after soldering, clean only the leads on the soldering side; do not dip the whole package for cleaning.
Chemicals remaining on a surface of LED or phototransistor, if any, would have a bad influence to the optical characteristics and it may severely lower the conversion efficiency.
- The environment to install the device should be determined carefully. Oil or chemicals may cause the package to be dissolved or cracked.
- The device should be mounted on an unwrapped surface.
- Install this device as avoiding the disturbance light as possible. A visible light cut-off type phototransistor which blocks light with frequencies of 700nm or above is used. However, the device cannot block infrared light with a wavelength of 700nm or more, and it may do mistaken movements.
- Conversion efficiency falls over time due to the current which flows in the infrared LED.
When designing a circuit, take into account this change in conversion efficiency over time.
The ratio of fluctuation in conversion efficiency to fluctuation in infrared LED optical output is 1:1.

$$\frac{I_C / I_F(t)}{I_C / I_F(0)} = \frac{P_O(t)}{P_O(0)}$$

Outline: TOSHIBA

Unit: mm

() : REFERENCE VALUE

Following table shows differences unless otherwise specified

Dimensions	Tolerant Differences
4 or less	± 0.1
4 or more and 18 or less	± 0.2

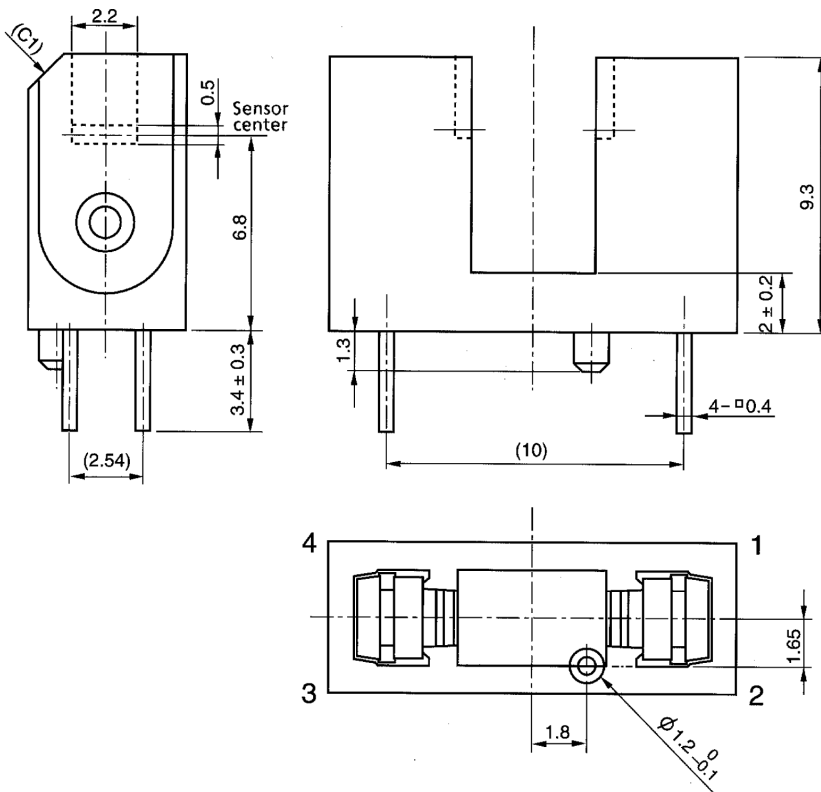
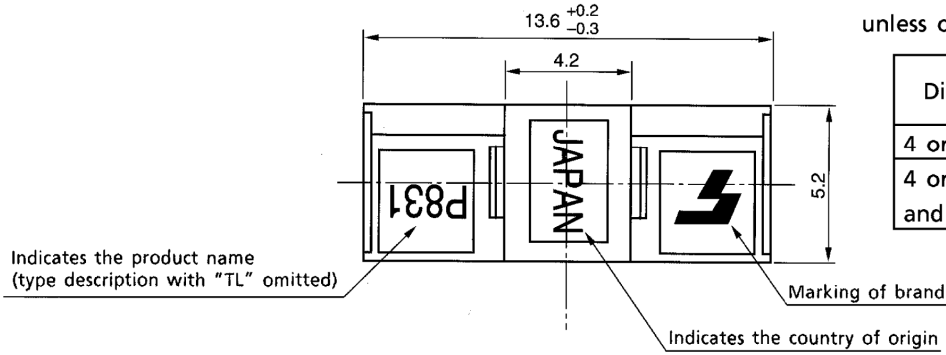

Weight: 0.58 g (typ.)

Pin Connection

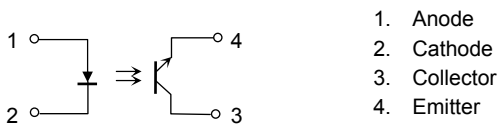

- 1. Anode
- 2. Cathode
- 3. Collector
- 4. Emitter

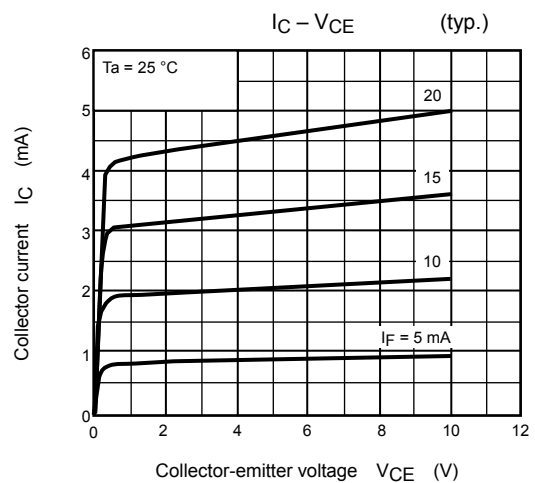
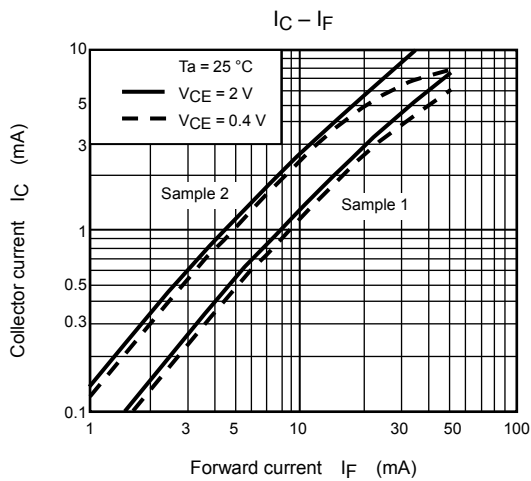
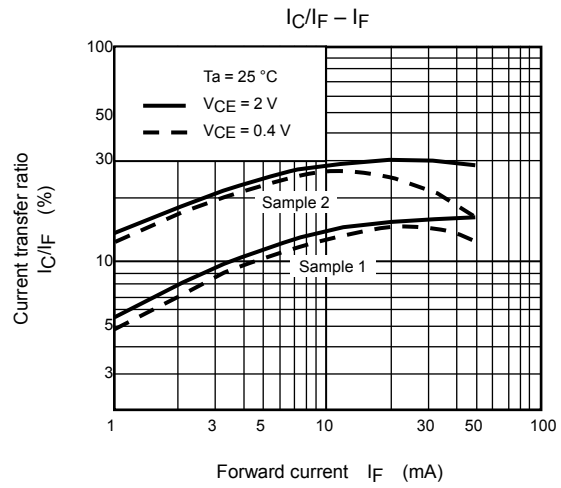
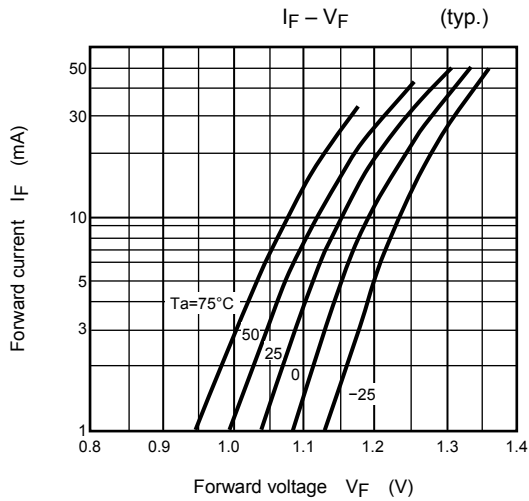
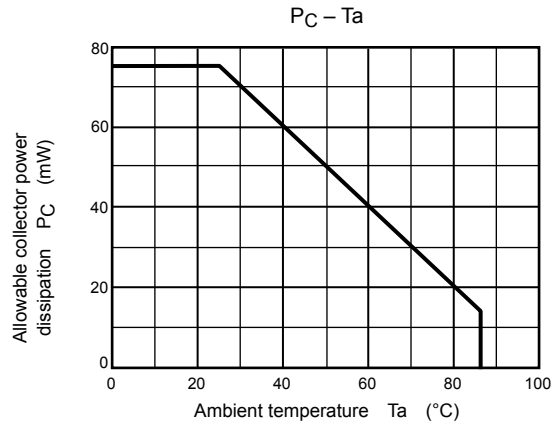
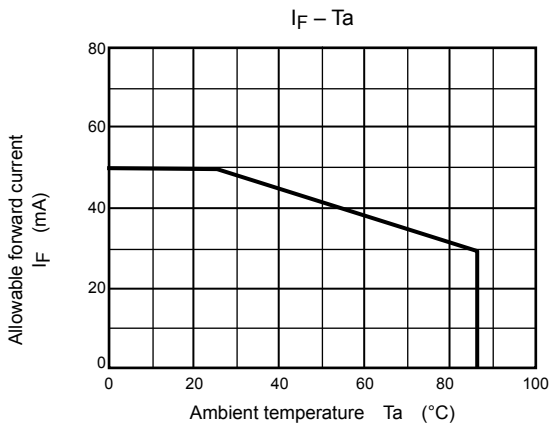

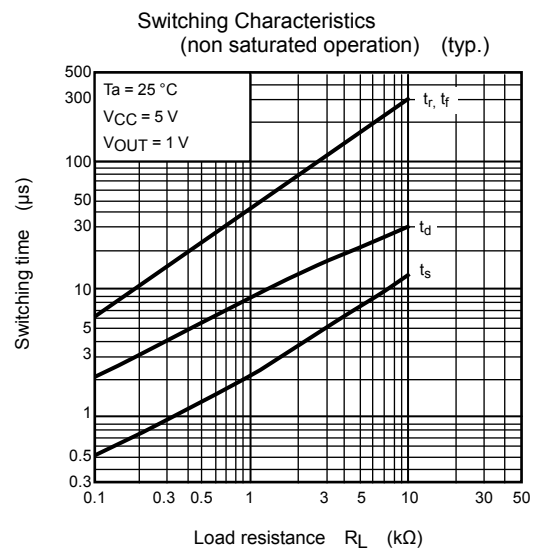
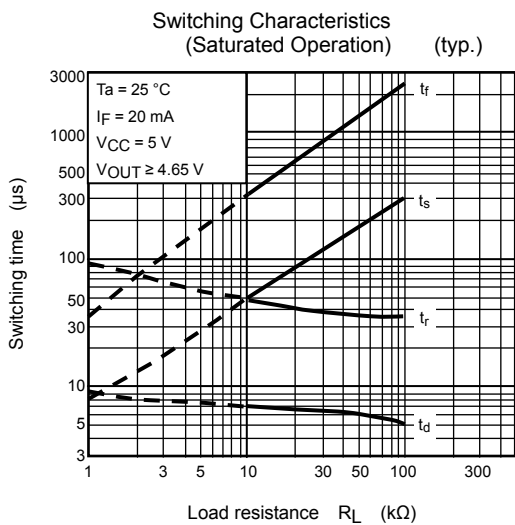
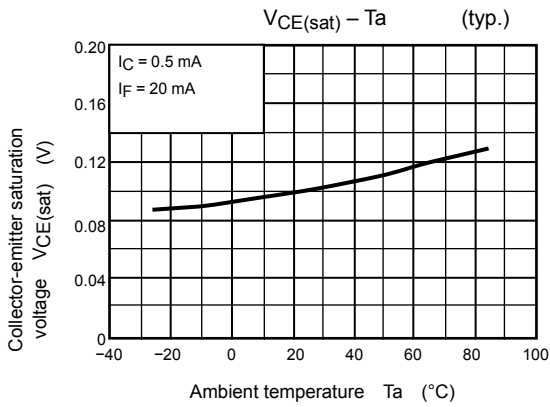
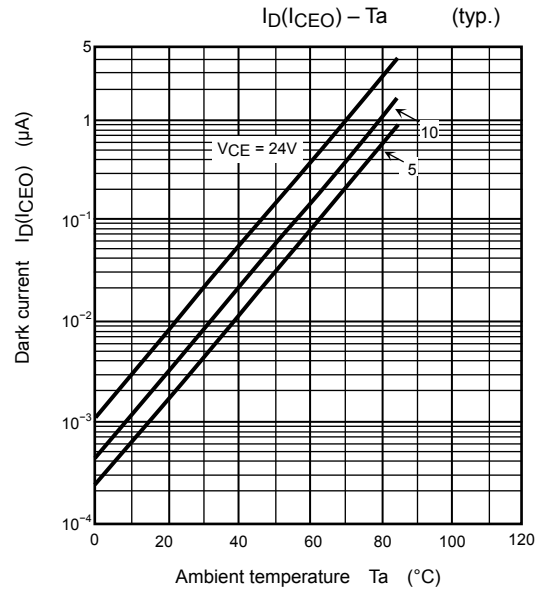
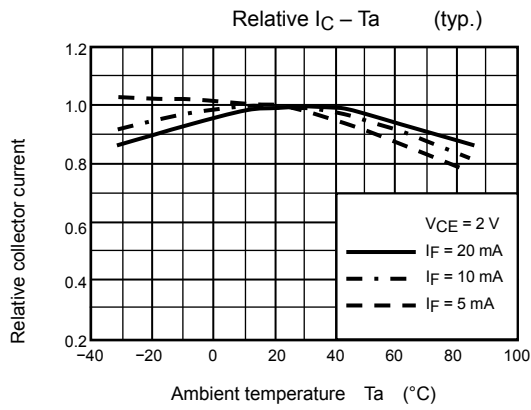

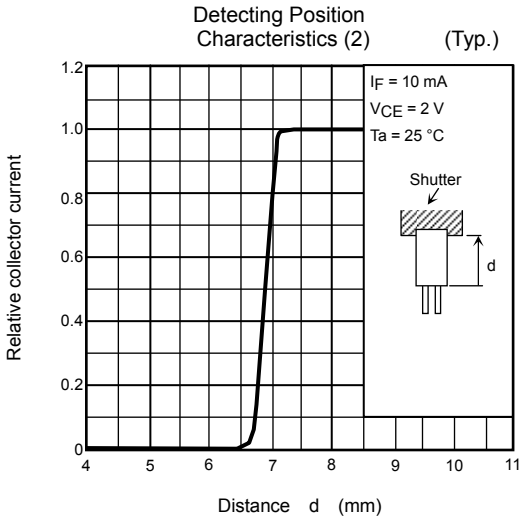
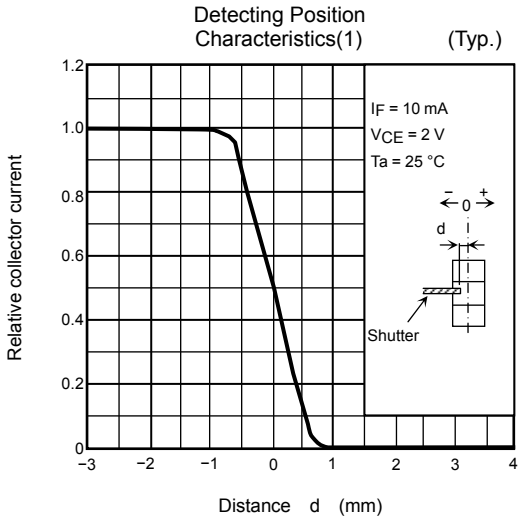

RESTRICTIONS ON PRODUCT USE

20070701-EN

- The information contained herein is subject to change without notice.
- TOSHIBA is continually working to improve the quality and reliability of its products. Nevertheless, semiconductor devices in general can malfunction or fail due to their inherent electrical sensitivity and vulnerability to physical stress. It is the responsibility of the buyer, when utilizing TOSHIBA products, to comply with the standards of safety in making a safe design for the entire system, and to avoid situations in which a malfunction or failure of such TOSHIBA products could cause loss of human life, bodily injury or damage to property.
In developing your designs, please ensure that TOSHIBA products are used within specified operating ranges as set forth in the most recent TOSHIBA products specifications. Also, please keep in mind the precautions and conditions set forth in the "Handling Guide for Semiconductor Devices," or "TOSHIBA Semiconductor Reliability Handbook" etc.
- The TOSHIBA products listed in this document are intended for usage in general electronics applications (computer, personal equipment, office equipment, measuring equipment, industrial robotics, domestic appliances, etc.). These TOSHIBA products are neither intended nor warranted for usage in equipment that requires extraordinarily high quality and/or reliability or a malfunction or failure of which may cause loss of human life or bodily injury ("Unintended Usage"). Unintended Usage include atomic energy control instruments, airplane or spaceship instruments, transportation instruments, traffic signal instruments, combustion control instruments, medical instruments, all types of safety devices, etc.. Unintended Usage of TOSHIBA products listed in this document shall be made at the customer's own risk.
- The products described in this document shall not be used or embedded to any downstream products of which manufacture, use and/or sale are prohibited under any applicable laws and regulations.
- The information contained herein is presented only as a guide for the applications of our products. No responsibility is assumed by TOSHIBA for any infringements of patents or other rights of the third parties which may result from its use. No license is granted by implication or otherwise under any patents or other rights of TOSHIBA or the third parties.
- GaAs(Gallium Arsenide) is used in this product. The dust or vapor is harmful to the human body. Do not break, cut, crush or dissolve chemically.
- Please contact your sales representative for product-by-product details in this document regarding RoHS compatibility. Please use these products in this document in compliance with all applicable laws and regulations that regulate the inclusion or use of controlled substances. Toshiba assumes no liability for damage or losses occurring as a result of noncompliance with applicable laws and regulations.