



3.3V 26-Channel, Three-Stateable Transmission Gate

DS3690

General Description

The DS3690 is a 26-channel, three-stateable transmission gate designed for transparent digital signal transfer when enabled and fast-gated bus isolation when the device is disabled. Each of the 26 independent channels can be used for input, output, or I/O signal applications, with a typical signal propagation delay of less than 10ns. Using the logic-control input, all channels can be simultaneously enabled for bus transmission or forced to a high-impedance condition to isolate a critical component on that bus.

The DS3690 operates on a single 3.3V (typical) power supply and is available in a space-saving 56-pin lead-free TQFN package.

Features

- ◆ 26 Bidirectional Channels
- ◆ Low Propagation Delay (< 10ns typ)
- ◆ High-Speed On/Off Time (< 20ns typ)
- ◆ 2.7V to 3.6V Supply
- ◆ Wide Temperature Range: -55°C to +85°C
- ◆ TQFN Package (5mm x 11mm x 0.8mm)

Applications

- POS Terminals
- PIN Pads
- Cryptographic Processors
- Gaming
- Lottery Terminals
- Industrial Controls and Monitoring

Ordering Information

PART	TEMP RANGE	PIN-PACKAGE
DS3690T+	-55°C to +85°C	56 TQFN
DS3690T+TRL	-55°C to +85°C	56 TQFN

+Denotes a lead-free package.

TRL = Tape and reel.

Pin Configuration

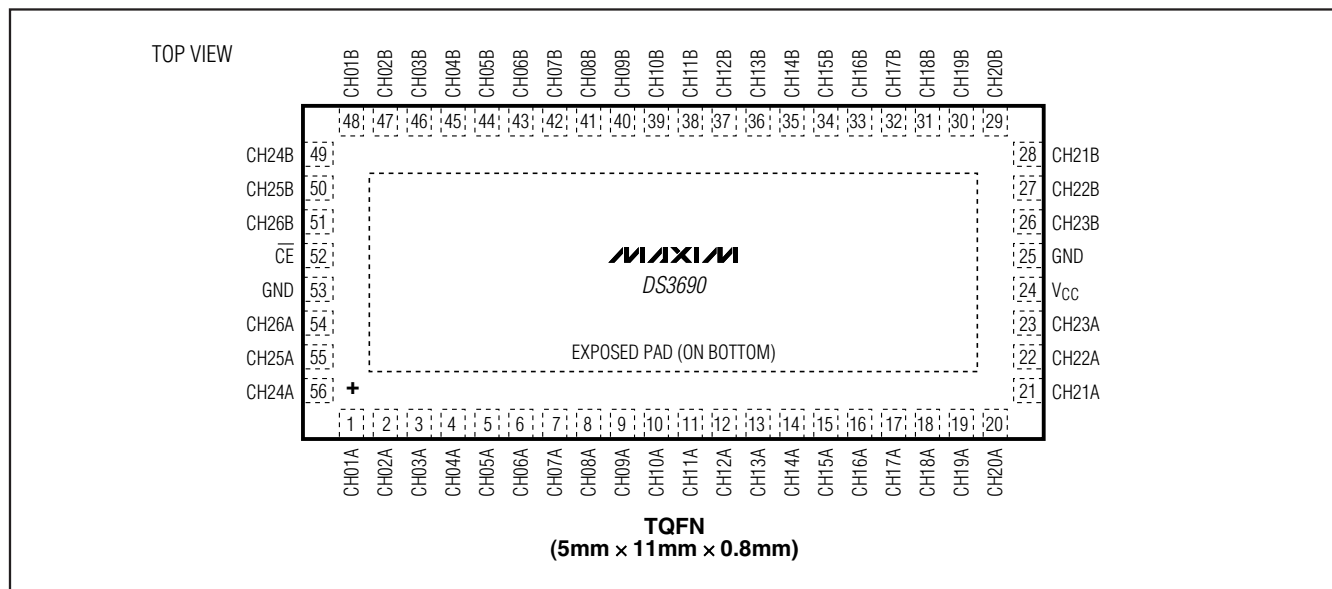

Typical Operating Circuit appears at end of data sheet.



3.3V 26-Channel, Three-Stateable Transmission Gate

ABSOLUTE MAXIMUM RATINGS

Voltage Range on Any Pin Relative to Ground.....-0.5V to +6.0V
 Operating Temperature Range-55°C to +85°C

Storage Temperature Range-55°C to +125°C
 Soldering Temperature.....Refer to IPC/JEDEC J-STD-020

Stresses beyond those listed under "Absolute Maximum Ratings" may cause permanent damage to the device. These are stress ratings only, and functional operation of the device at these or any other conditions beyond those indicated in the operational sections of the specifications is not implied. Exposure to absolute maximum rating conditions for extended periods may affect device reliability.

RECOMMENDED OPERATING CONDITIONS

($T_A = -55^\circ\text{C}$ to $+85^\circ\text{C}$)

PARAMETER	SYMBOL	CONDITIONS	MIN	TYP	MAX	UNITS
Supply Voltage	V_{CC}	(Note 1)	2.7	3.3	3.6	V
Input Logic 1	V_{IH}	(Note 1)	$0.7 \times V_{CC}$		$V_{CC} + 0.3$	V
Input Logic 0	V_{IL}	(Note 1)	-0.3		$0.3 \times V_{CC}$	V

DC ELECTRICAL CHARACTERISTICS

($V_{CC} = +2.7\text{V}$ to $+3.6\text{V}$, $T_A = -55^\circ\text{C}$ to $+85^\circ\text{C}$, unless otherwise noted.)

PARAMETER	SYMBOL	CONDITIONS	MIN	TYP	MAX	UNITS
Standby Current	I_{CC}	$\overline{CE} = \text{CH1} \rightarrow \text{CH26} = V_{CC}$, $I_{OUT} = 0\text{mA}$			1	μA
Input Leakage Current (\overline{CE})	I_I	$V_{IN} = 0\text{V}$ to V_{CC} , $T_A = +25^\circ\text{C}$	-0.1		+0.1	μA
I/O Leakage Current	I_{IO}	$\overline{CE} = V_{IH}$	-1.0		+1.0	μA

AC ELECTRICAL CHARACTERISTICS

($V_{CC} = +2.7\text{V}$ to $+3.6\text{V}$, $T_A = -55^\circ\text{C}$ to $+85^\circ\text{C}$, unless otherwise noted.)

PARAMETER	SYMBOL	CONDITIONS	MIN	TYP	MAX	UNITS
Propagation Delay (A to B or B to A)	t_{PD}	$\overline{CE} = V_{IL}$ (Note 2)			10	ns
Chip Enable to Output Valid	t_{CEV}	(Notes 2, 3)			20	ns
Chip Enable to Output Deselect	t_{CEZ}	(Notes 2, 3)			20	ns
Input to \overline{CE} Setup Time	t_{IS}	(Note 4)	0			ns
Skew Between Channels	t_S	(Notes 5, 6)			1	ns

AC TEST CONDITIONS

Input Pulse Levels: $V_{IL} = 0.0\text{V}$, $V_{IH} = 2.7\text{V}$
 Input Pulse Rise and Fall Times: 5ns
 Input and Output Timing Reference Level: $V_{CC}/2$
 Output Load: C_L (100pF)

3.3V 26-Channel, Three-Stateable Transmission Gate

DS3690

CAPACITANCE

($T_A = +25^\circ\text{C}$)

PARAMETER	SYMBOL	CONDITIONS	MIN	TYP	MAX	UNITS
Input Capacitance ($\overline{\text{CE}}$)	C_{IN}	Not production tested		5		pF
I/O Capacitance	C_{IO}	Not production tested		8		pF

Note 1: All voltages referenced to ground.

Note 2: Typical waveform shown is labeled CHxxA (input) to CHxxB (output), and is identical in function when selecting pin CHxxB (as the input) to pin CHxxA (as the output).

Note 3: Output reference level is $V_{\text{CC}}/2$.

Note 4: Input transitions prior to the $\overline{\text{CE}}$ falling edge are ignored (don't care).

Note 5: Propagation delay differential between any two channels when using a common input signal source.

Note 6: Guaranteed by design and not 100% tested.

Timing Diagrams

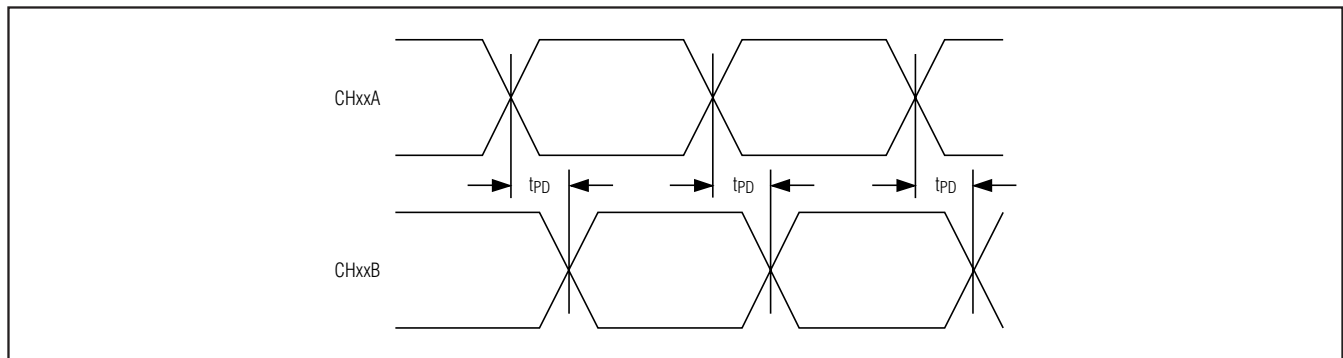

Figure 1. Digital Channel Propagation Delay

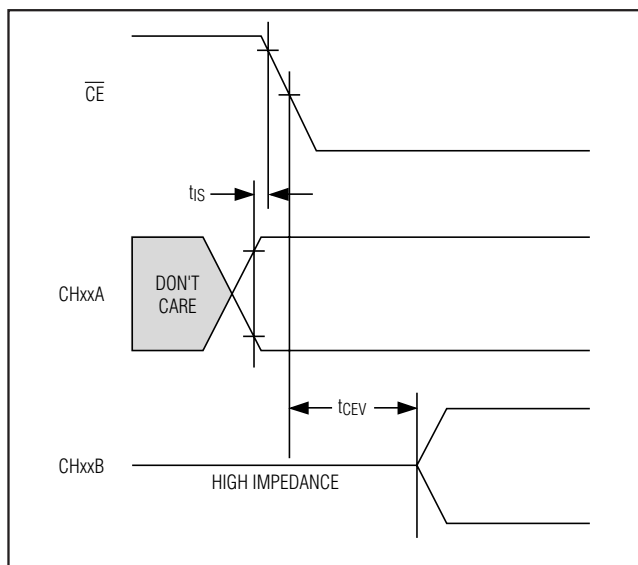

Figure 2. Digital Channels Enabled by $\overline{\text{CE}}$

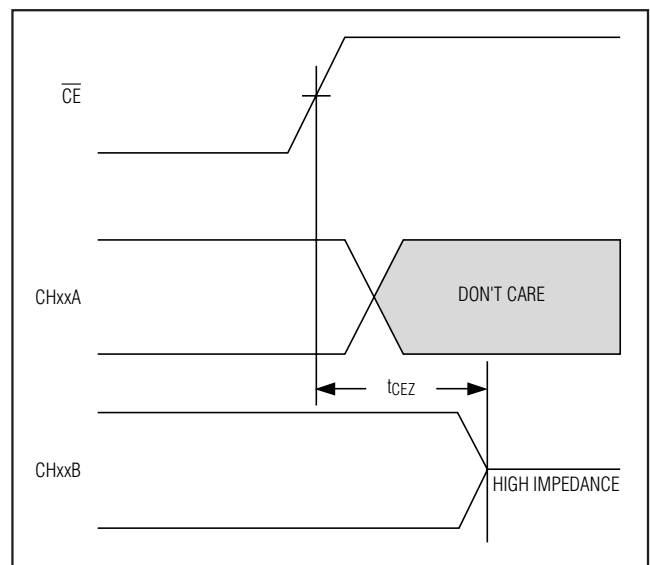
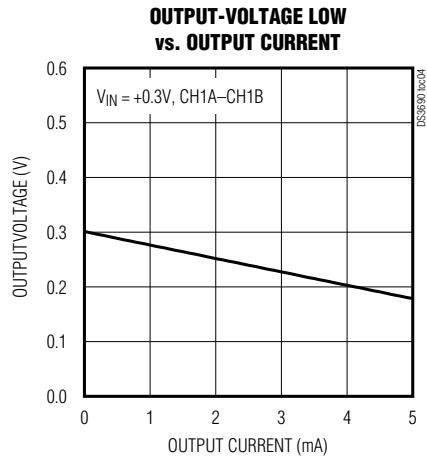
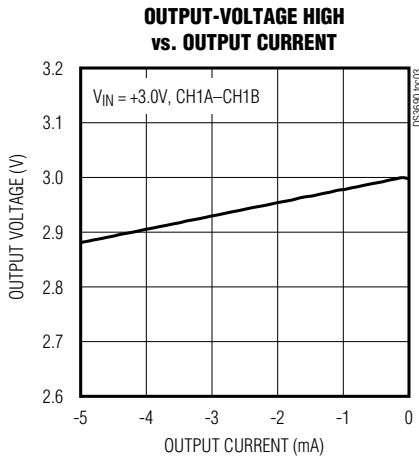
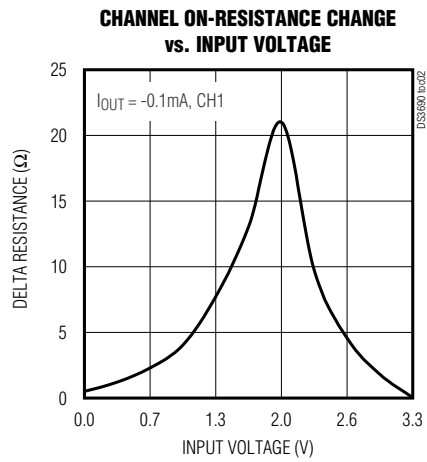
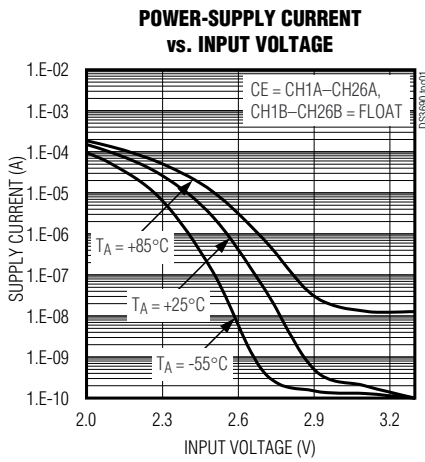

Figure 3. Digital Channels Disabled by $\overline{\text{CE}}$

3.3V 26-Channel, Three-Stateable Transmission Gate

Typical Operating Characteristics

($V_{CC} = 3.3V$, $T_A = +25^\circ C$, unless otherwise noted.)



3.3V 26-Channel, Three-Stateable Transmission Gate

Pin Description

DS3690

PIN	NAME	FUNCTION
1	CH01A	Channel 1 Terminal A
2	CH02A	Channel 2 Terminal A
3	CH03A	Channel 3 Terminal A
4	CH04A	Channel 4 Terminal A
5	CH05A	Channel 5 Terminal A
6	CH06A	Channel 6 Terminal A
7	CH07A	Channel 7 Terminal A
8	CH08A	Channel 8 Terminal A
9	CH09A	Channel 9 Terminal A
10	CH10A	Channel 10 Terminal A
11	CH11A	Channel 11 Terminal A
12	CH12A	Channel 12 Terminal A
13	CH13A	Channel 13 Terminal A
14	CH14A	Channel 14 Terminal A
15	CH15A	Channel 15 Terminal A
16	CH16A	Channel 16 Terminal A
17	CH17A	Channel 17 Terminal A
18	CH18A	Channel 18 Terminal A
19	CH19A	Channel 19 Terminal A
20	CH20A	Channel 20 Terminal A
21	CH21A	Channel 21 Terminal A
22	CH22A	Channel 22 Terminal A
23	CH23A	Channel 23 Terminal A
24	V _{CC}	Supply Voltage
25, 53	GND	Ground
26	CH23B	Channel 23 Terminal B
27	CH22B	Channel 22 Terminal B
28	CH21B	Channel 21 Terminal B
29	CH20B	Channel 20 Terminal B

PIN	NAME	FUNCTION
30	CH19B	Channel 19 Terminal B
31	CH18B	Channel 18 Terminal B
32	CH17B	Channel 17 Terminal B
33	CH16B	Channel 16 Terminal B
34	CH15B	Channel 15 Terminal B
35	CH14B	Channel 14 Terminal B
36	CH13B	Channel 13 Terminal B
37	CH12B	Channel 12 Terminal B
38	CH11B	Channel 11 Terminal B
39	CH10B	Channel 10 Terminal B
40	CH09B	Channel 9 Terminal B
41	CH08B	Channel 8 Terminal B
42	CH07B	Channel 7 Terminal B
43	CH06B	Channel 6 Terminal B
44	CH05B	Channel 5 Terminal B
45	CH04B	Channel 4 Terminal B
46	CH03B	Channel 3 Terminal B
47	CH02B	Channel 2 Terminal B
48	CH01B	Channel 1 Terminal B
49	CH24B	Channel 24 Terminal B
50	CH25B	Channel 25 Terminal B
51	CH26B	Channel 26 Terminal B
52	$\overline{\text{CE}}$	Chip-Enable Input (Active Low)
54	CH26A	Channel 26 Terminal A
55	CH25A	Channel 25 Terminal A
56	CH24A	Channel 24 Terminal A
—	EP	Exposed Paddle. Must be connected to ground.

3.3V 26-Channel, Three-Stateable Transmission Gate

Detailed Description

The DS3690 is a 26-channel, noninverting, bidirectional CMOS transmission gate, and is intended for use in applications where a downstream component must be isolated from a common control, address, or data bus in a timely fashion. Each of the 26 independent channels can be used for input, output, or I/O signal applications. The chip-enable input (\overline{CE}) allows gated bus control for either signal transmission or bus isolation.

Each independent channel consists of two pins ("CHxxA" and "CHxxB" where xx is 01–26). Since all 26 channels are capable of bidirectional function, either CHxxA or CHxxB can be selected as the input pin for any unidirectional signal requirements. A change of logic state on one side of any channel is directly reflected on the other side of that channel. Signal propagation delay (CHxxA to CHxxB, or CHxxB to CHxxA) is illustrated in Figure 1 as t_{PD} .

All channels can be simultaneously enabled or forced to a high-impedance state using the \overline{CE} input. When \overline{CE} becomes a logic zero, all channels are enabled for signal transmission within t_{CEV} (see Figure 2). When \overline{CE} becomes a logic one, all channels are forced to a high-impedance state within t_{CEZ} (see Figure 3).

Applications Information

Power-Supply Decoupling

To achieve the best results when using the DS3690, decouple the power supply with a 0.1 μ F capacitor. Use a high-quality, ceramic surface-mount capacitor if possible. Surface-mount components minimize lead inductance, which improves performance, while ceramic capacitors have adequately high-frequency response for decoupling applications.

Pin Connections

For optimum circuit operation, connect pins 25 and 53 to a common ground. The exposed pad on the package bottom side should be connected to ground.

To prevent an unused transmission channel from generating any undesired activity, it is recommended that **one side** of that unused channel be connected to ground (either the A or B terminal, at the designer's discretion).

Typical Operating Circuit

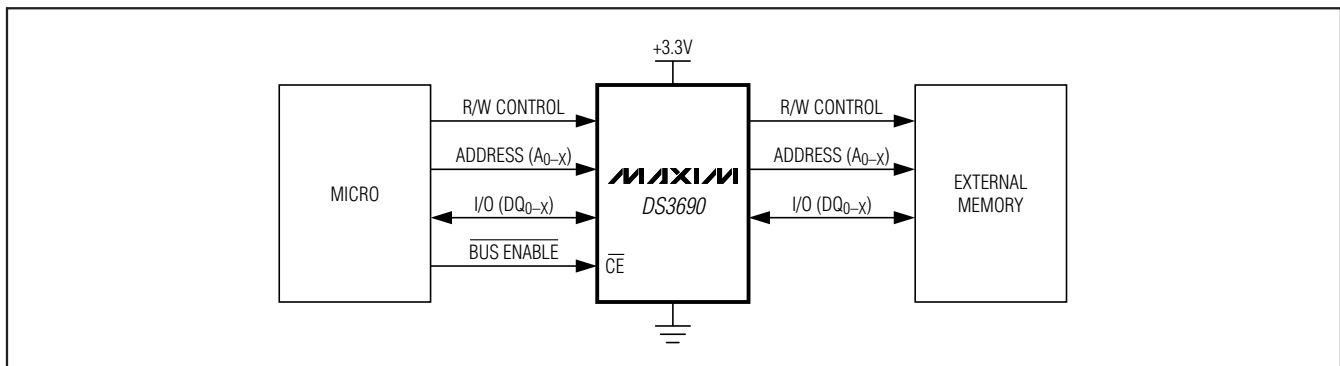

3.3V 26-Channel, Three-Stateable Transmission Gate

Functional Diagram

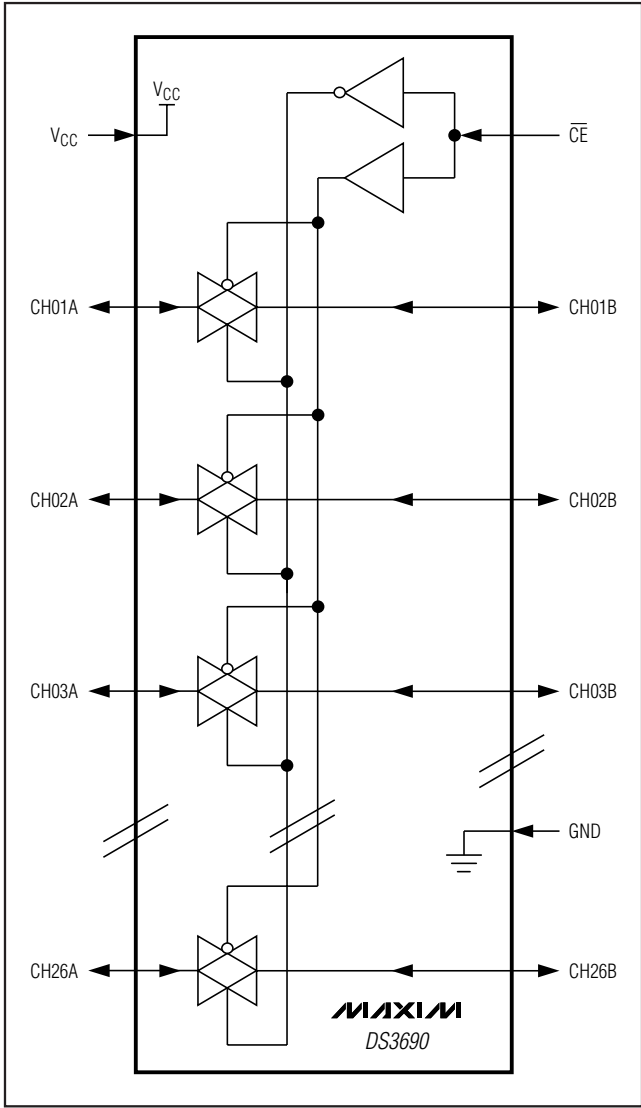

Package Information

(For the latest package outline information, go to www.maxim-ic.com/DallasPackInfo.)

PACKAGE TYPE	DOCUMENT NO.
56 TQFN	21-0187

DS3690

Maxim cannot assume responsibility for use of any circuitry other than circuitry entirely embodied in a Maxim product. No circuit patent licenses are implied. Maxim reserves the right to change the circuitry and specifications without notice at any time.

Maxim Integrated Products, 120 San Gabriel Drive, Sunnyvale, CA 94086 408-737-7600 _____ 7