

BRIGHT LED ELECTRONICS CORP.

SURFACE MOUNT CHIP LED LAMP SPECIFICATION

●COMMODITY : SURFACE MOUNT CHIP LED LAMP

●DEVICE NUMBER : BL-HKD36D

PAGE: 2

●ELECTRICAL AND OPTICAL CHARACTERISTICS (Ta=25°C)

REVISION: 1.1

Chip			Lens Appearance	Absolute Maximum Rating				Electro-optical Data (At 20mA)				Viewing Angle 2θ 1/2 (deg)
Emitted Color	Peak Wave Length λ p(nm)	Dominant Wave Length λ d(nm)		Δ λ (nm)	Pd (mW)	If (mA)	Peak If(mA)	Vf(V)		Iv (mcd)		
								Typ.	Max.	Min	Typ.	
Super Yellow	595	594±5	Water Clear	15	100	30	100	2.1	2.6	28.0	50.0	120

Remark : Viewing angle is the Off-axis angle at which the luminous intensity is half the axial luminous intensity.

●ABSOLUTE MAXIMUM RATINGS (Ta=25°C)

Reverse Voltage	5V
Reverse Current (V _R =5V)	≤ 100μA
Operating Temperature Range	-25°C ~ 80°C
Storage Temperature Range	-30°C ~ 85°C

●PACKAGE DIMENSIONS

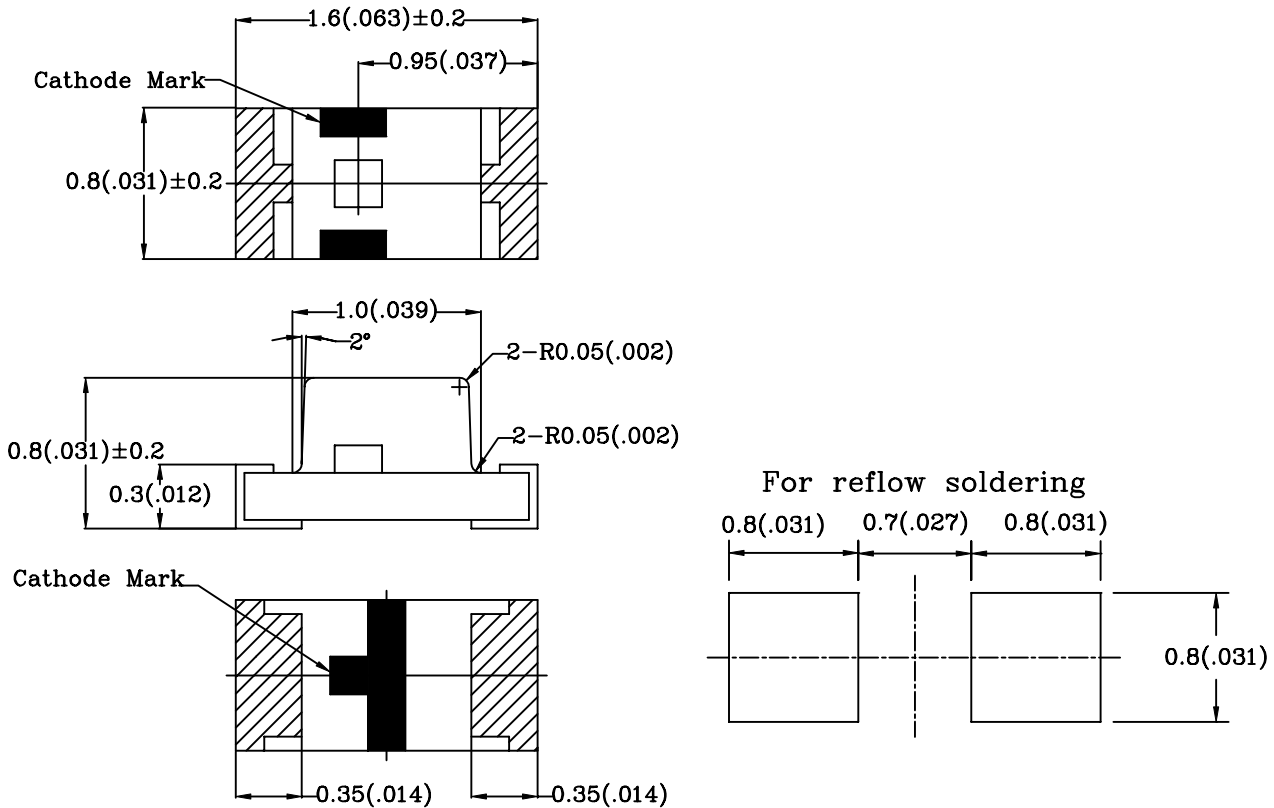

- NOTES: 1.All dimensions are in millimeters (inches).
 2.Tolerance is ± 0.10mm (0.004) unless otherwise specified.
 3.Specifications are subject to change without notice.
 4.Condition for IFp is pulse of 1/10 duty and 0.1msec width.

BRIGHT LED ELECTRONICS CORP.

SURFACE MOUNT CHIP LED LAMP SPECIFICATION

●COMMODITY : SURFACE MOUNT CHIP LED LAMP

PAGE: 3

●DEVICE NUMBER : BL-HKD36D

REVISION: 1.1

Fig.1 RELATIVE INTENSITY VS. WAVELENGTH

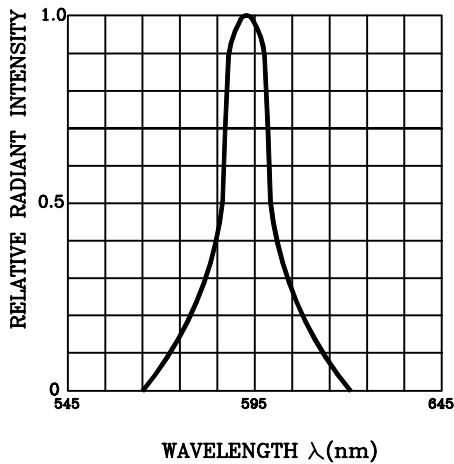

Fig.2 FORWARD CURRENT DERATING CURVE

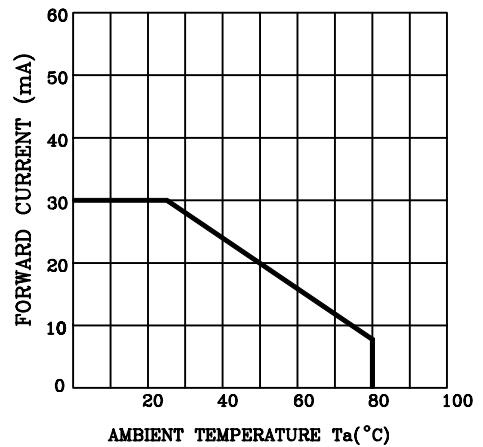

Fig.3 FORWARD CURRENT VS. FORWARD VOLTAGE

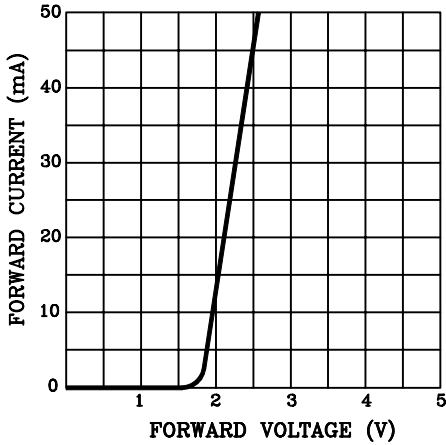

Fig.4 RELATIVE LUMINOUS INTENSITY VS. AMBIENT TEMPERATURE

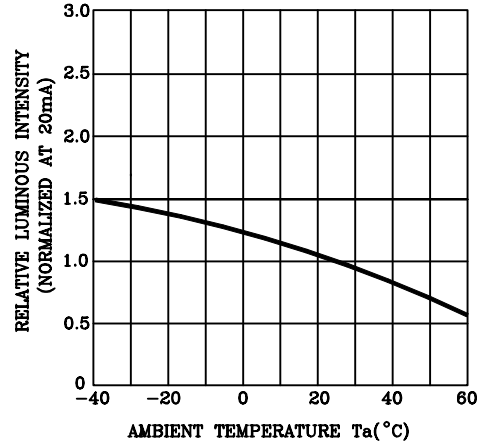

Fig.5 RELATIVE LUMINOUS INTENSITY VS. FORWARD CURRENT

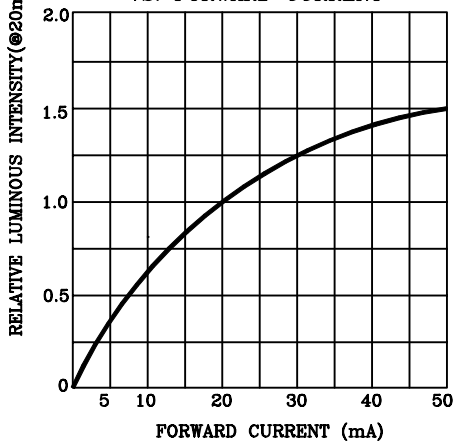
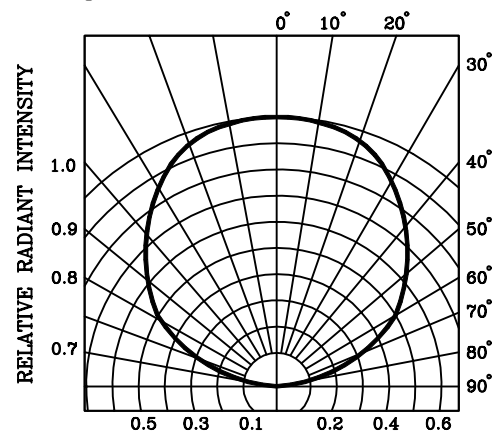

Fig.6 RADIATION DIAGRAM



BRIGHT LED ELECTRONICS CORP.

SURFACE MOUNT CHIP LED LAMP SPECIFICATION

● COMMODITY : SURFACE MOUNT CHIP LED LAMP

● DEVICE NUMBER : BL-HKD36D-TRB

PAGE: 4

● -TRB: TAPPING & REELING, BLACK CAMRIER TAPE, ESD RESISTED.

REVISION: 1.1

● TAPPING AND PACKAGING SPECIFICATION

ITEM	SYMBOL	SPECIFICATION			
		Minimum		Maximum	
		mm	inch	mm	inch
Tape Feed Hole Diameter (DIA)	D_0	1.40	0.055	1.60	0.063
Feed Hole Location	E	1.65	0.064	1.85	0.073
Centers Line Dimensions Length Direction	F	3.45	0.135	3.55	0.139
Compartment Depth	K_0	0.94	0.037	1.14	0.045
Compartment Pitch	P	3.90	0.153	4.10	0.161
Sprocket Hole Diameter	P_0	3.90	0.153	4.10	0.161
Centers Line Dimensions Length Direction	P_2	1.95	0.076	2.05	0.080
Carrier Tape Thickness	t	—	—	0.30	0.012
Carrier Tape Width	W	7.70	0.303	8.30	0.326
Flange Diameter	A	178.0	7.008	180.0	7.087
Hub Spindle Hole	C	12.50	0.492	13.50	0.531
Hub Diameter	D_2	70.00	2.755	72.00	2.830
Fixing Tape Width	W_1	5.25	0.206	5.35	0.210
Flange Space Between Flanges	T	12.50	0.492	13.50	0.531
Compartment Length	A_0	0.98	0.039	1.18	0.047
Compartment Width	B_0	1.78	0.071	1.98	0.078

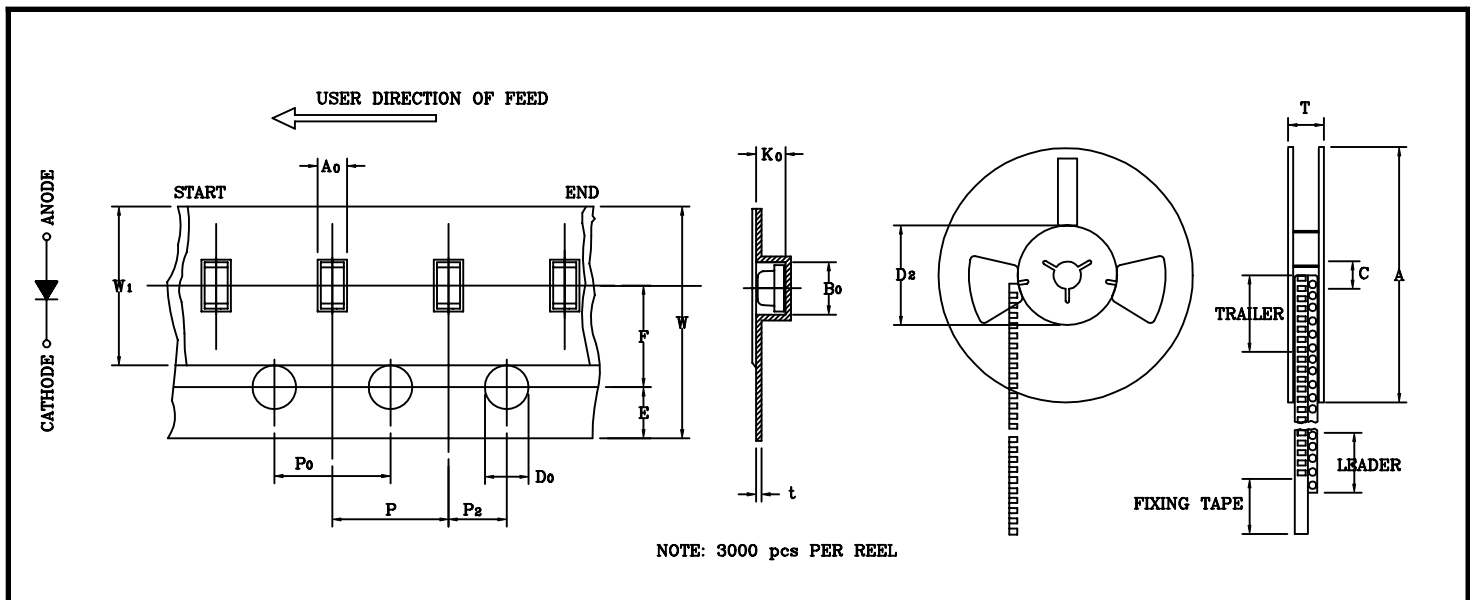

BRIGHT LED ELECTRONICS CORP.

SURFACE MOUNT CHIP LED LAMP SPECIFICATION

RELIABILITY TEST

PAGE: 5

REVISION: 1.0

Classification	Test Item	Reference Standard	Test Conditions	Result
Endurance Test	Operation Life	MIL-STD-750:1026 MIL-STD-883:1005 JIS C 7021 :B-1	Connect with a power $I_f=20\text{mA}$ T_a =Under room temperature Test time=1,000hrs	0/20
	High Temperature High Humidity Storage	MIL-STD-202:103B JIS C 7021 :B-11	$T_a=+65^\circ\text{C}\pm 5^\circ\text{C}$ RH=90%-95% Test time=240hrs	0/20
	High Temperature Storage	MIL-STD-883:1008 JIS C 7021 :B-10	High $T_a=+85^\circ\text{C}\pm 5^\circ\text{C}$ Test time=1,000hrs	0/20
	Low Temperature Storage	JIS-C-7021 :B-12	Low $T_a=-35^\circ\text{C}\pm 5^\circ\text{C}$ Test time=1,000hrs	0/20
Environmental Test	Temperature Cycling	MIL-STD-202:107D MIL-STD-750:1051 MIL-STD-883:1010 JIS C 7021 :A-4	$-35^\circ\text{C} \sim +25^\circ\text{C} \sim +85^\circ\text{C} \sim +25^\circ\text{C}$ 60min 20min 60min 20min Test Time=5cycle	0/20
	Thermal Shock	MIL-STD-202:107D MIL-STD-750:1051 MIL-STD-883:1011	$-35^\circ\text{C}\pm 5^\circ\text{C} \sim +85^\circ\text{C}\pm 5^\circ\text{C}$ 20min 20min Test Time=10cycle	0/20
	Solder Resistance	MIL-STD-202:201A MIL-STD-750:2031 JIS C 7021 :A-1	Preheating : $140^\circ\text{C} - 160^\circ\text{C}$, within 2 minutes. Operation heating : 235°C (Max.), within 10seconds. (Max.)	0/20

JUDGMENT CRITERIA OF FAILURE FOR THE RELIABILITY

Measuring items	Symbol	Measuring conditions	Judgement criteria for failure
Forward voltage	V_F (V)	$I_f=20\text{mA}$	Over $U_x1.2$
Reverse current	I_r (μA)	$V_r=5\text{V}$	Over U_x2
Luminous intensity	I_v (mcd)	$I_f=20\text{mA}$	Below $SX0.5$

Note: 1.U means the upper limit of specified characteristics. S means initial value.

2.Measurment shall be taken between 2 hours and after the test pieces have been returned to normal ambient conditions after completion of each test.

BRIGHT LED ELECTRONICS CORP.

SURFACE MOUNT CHIP LED LAMP SPECIFICATION

PAGE: 6

REVISION: 1.0

1. SOLDERING:

● Manual Of Soldering

The temperature of the iron tip should not be higher than 300°C (572°F) and Soldering within 3 seconds per solder-land is to be observed.

● Reflow Soldering

Preheating : 140°C~160°C±5°C, within 2 minutes.

Operation heating : 235°C (MAX.) within 10 seconds.(Max)

Gradual Cooling (Avoid quenching).

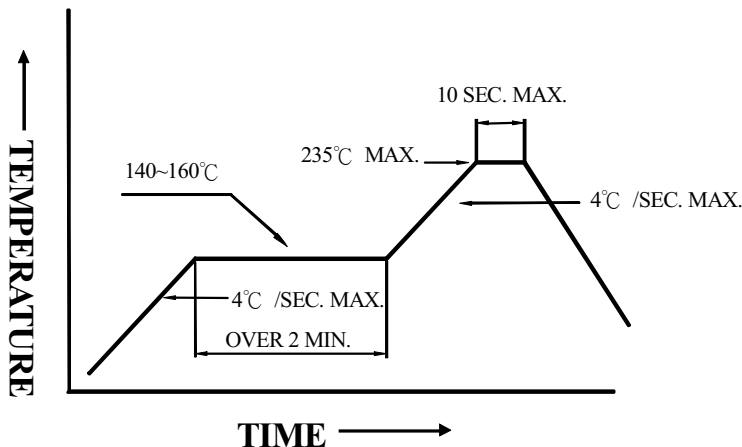

● DIP soldering (Wave Soldering)

Preheating : 120°C~150°C, within 120~180 sec.

Operation heating : 245°C±5°C within 5 sec. 260°C (Max)

Gradual Cooling (Avoid quenching).

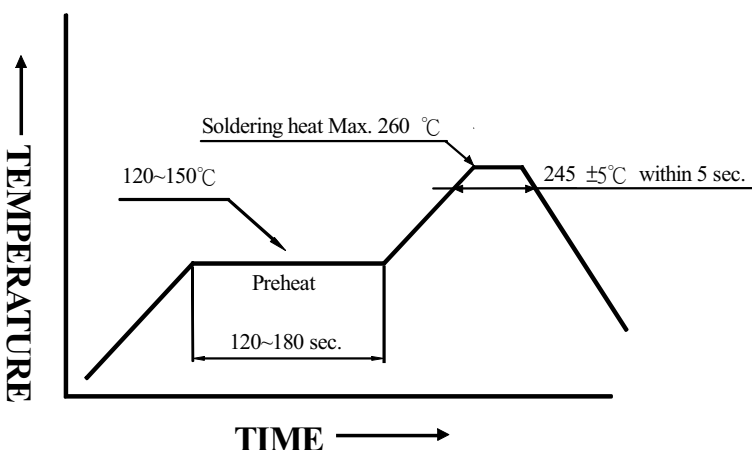

2. Handling :

Care must be taken not to cause to the epoxy resin portion of BRIGHT LEDs while it is exposed to high temperature.

Care must be taken not rub the epoxy resin portion of BRIGHT LEDs with hard or sharp article such as the sand blast and the metal hook.