

$V_{CE} = 3300 \text{ V}$
 $I_C = 1200 \text{ A}$

ABB HiPak™

IGBT Module
5SNA 1200G330100

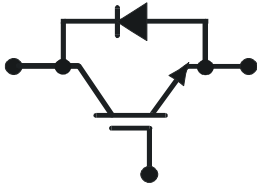

Doc. No. 5SYA1563-00 Apr.06

- Low-loss, rugged SPT chip-set
- Smooth switching SPT chip-set for good EMC
- High insulation package
- High power density
- AlSiC base-plate for high power cycling capability
- AlN substrate for low thermal resistance



Maximum rated values ¹⁾

Parameter	Symbol	Conditions	min	max	Unit
Collector-emitter voltage	V_{CES}	$V_{GE} = 0 \text{ V}$		3300	V
DC collector current	I_C	$T_c = 80 \text{ °C}$		1200	A
Peak collector current	I_{CM}	$t_p = 1 \text{ ms}, T_c = 80 \text{ °C}$		2400	A
Gate-emitter voltage	V_{GES}		-20	20	V
Total power dissipation	P_{tot}	$T_c = 25 \text{ °C}$, per switch (IGBT)		11750	W
DC forward current	I_F			1200	A
Peak forward current	I_{FRM}			2400	A
Surge current	I_{FSM}	$V_R = 0 \text{ V}, T_{vj} = 125 \text{ °C}$, $t_p = 10 \text{ ms}$, half-sinewave		14000	A
IGBT short circuit SOA	t_{psc}	$V_{CC} = 2500 \text{ V}, V_{CEMCHIP} \leq 3300 \text{ V}$ $V_{GE} \leq 15 \text{ V}, T_{vj} \leq 125 \text{ °C}$		10	μs
Isolation voltage	V_{isol}	1 min, $f = 50 \text{ Hz}$		10200	V
Junction temperature	T_{vj}			125	$^{\circ}\text{C}$
Junction operating temperature	$T_{vj(op)}$		-40	125	$^{\circ}\text{C}$
Case temperature	T_c		-40	125	$^{\circ}\text{C}$
Storage temperature	T_{stg}		-40	125	$^{\circ}\text{C}$
Mounting torques ²⁾	M_s	Base-heatsink, M6 screws	4	6	Nm
	M_{t1}	Main terminals, M8 screws	8	10	
	M_{t2}	Auxiliary terminals, M4 screws	2	3	

¹⁾ Maximum rated values indicate limits beyond which damage to the device may occur per IEC 60747

²⁾ For detailed mounting instructions refer to ABB Document No. 5SYA2039

ABB Switzerland Ltd, Semiconductors reserves the right to change specifications without notice.



IGBT characteristic values ³⁾

Parameter	Symbol	Conditions	min	typ	max	Unit
Collector (-emitter) breakdown voltage	$V_{(BR)CES}$	$V_{GE} = 0 \text{ V}$, $I_C = 10 \text{ mA}$, $T_{vj} = 25 \text{ °C}$	3300			V
Collector-emitter ⁴⁾ saturation voltage	$V_{CE \text{ sat}}$	$I_C = 1200 \text{ A}$, $V_{GE} = 15 \text{ V}$		3.1		V
		$T_{vj} = 25 \text{ °C}$				V
		$T_{vj} = 125 \text{ °C}$	3.5	3.85	4.3	V
Collector cut-off current	I_{CES}	$V_{CE} = 3300 \text{ V}$, $V_{GE} = 0 \text{ V}$			12	mA
		$T_{vj} = 25 \text{ °C}$			120	mA
		$T_{vj} = 125 \text{ °C}$				mA
Gate leakage current	I_{GES}	$V_{CE} = 0 \text{ V}$, $V_{GE} = \pm 20 \text{ V}$, $T_{vj} = 125 \text{ °C}$	-500		500	nA
Gate-emitter threshold voltage	$V_{GE(TO)}$	$I_C = 240 \text{ mA}$, $V_{CE} = V_{GE}$, $T_{vj} = 25 \text{ °C}$	5.5		7.5	V
Gate charge	Q_{ge}	$I_C = 1200 \text{ A}$, $V_{CE} = 1800 \text{ V}$, $V_{GE} = -15 \text{ V} \dots 15 \text{ V}$		10.9		μC
Input capacitance	C_{ies}	$V_{CE} = 25 \text{ V}$, $V_{GE} = 0 \text{ V}$, $f = 1 \text{ MHz}$, $T_{vj} = 25 \text{ °C}$		187		nF
Output capacitance	C_{oes}			11.6		
Reverse transfer capacitance	C_{res}			2.22		
Turn-on delay time	$t_{d(on)}$	$V_{CC} = 1800 \text{ V}$, $I_C = 1200 \text{ A}$, $R_G = 1.5 \text{ }\Omega$,	$T_{vj} = 25 \text{ °C}$	530		ns
			$T_{vj} = 125 \text{ °C}$	500		
Rise time	t_r	$V_{GE} = \pm 15 \text{ V}$, $L_\sigma = 125 \text{ nH}$, inductive load	$T_{vj} = 25 \text{ °C}$	230		ns
			$T_{vj} = 125 \text{ °C}$	230		
Turn-off delay time	$t_{d(off)}$	$V_{CC} = 1800 \text{ V}$, $I_C = 1200 \text{ A}$, $R_G = 1.5 \text{ }\Omega$,	$T_{vj} = 25 \text{ °C}$	1200		ns
			$T_{vj} = 125 \text{ °C}$	1330		
Fall time	t_f	$V_{GE} = \pm 15 \text{ V}$, $L_\sigma = 125 \text{ nH}$, inductive load	$T_{vj} = 25 \text{ °C}$	350		ns
			$T_{vj} = 125 \text{ °C}$	440		
Turn-on switching energy	E_{on}	$V_{CC} = 1800 \text{ V}$, $I_C = 1200 \text{ A}$, $V_{GE} = \pm 15 \text{ V}$, $R_G = 1.5 \text{ }\Omega$, $L_\sigma = 125 \text{ nH}$, inductive load	$T_{vj} = 25 \text{ °C}$	1260		mJ
			$T_{vj} = 125 \text{ °C}$	1730		
Turn-off switching energy	E_{off}	$V_{CC} = 1800 \text{ V}$, $I_C = 1200 \text{ A}$, $V_{GE} = \pm 15 \text{ V}$, $R_G = 1.5 \text{ }\Omega$, $L_\sigma = 125 \text{ nH}$, inductive load	$T_{vj} = 25 \text{ °C}$	1340		mJ
			$T_{vj} = 125 \text{ °C}$	1900		
Short circuit current	I_{SC}	$t_{psc} \leq 10 \text{ }\mu\text{s}$, $V_{GE} = 15 \text{ V}$, $T_{vj} = 125 \text{ °C}$, $V_{CC} = 2500 \text{ V}$, $V_{CEM \text{ CHIP}} \leq 3300 \text{ V}$		5100		A
Module stray inductance	$L_{\sigma \text{ CE}}$			18		nH
Resistance, terminal-chip	$R_{CC'+EE'}$		$T_C = 25 \text{ °C}$	0.07		m Ω
			$T_C = 125 \text{ °C}$	0.1		

³⁾ Characteristic values according to IEC 60747 – 9⁴⁾ Collector-emitter saturation voltage is given at chip level

Diode characteristic values⁵⁾

Parameter	Symbol	Conditions	min	typ	max	Unit
Forward voltage ⁶⁾	V_F	$I_F = 1200\text{ A}$	$T_{vj} = 25\text{ °C}$	2.3		V
			$T_{vj} = 125\text{ °C}$	2.0	2.35	
Reverse recovery current	I_{rr}	$V_{CC} = 1800\text{ V},$ $I_F = 1200\text{ A},$ $V_{GE} = \pm 15\text{ V},$ $R_G = 1.5\ \Omega$ $L_\sigma = 125\text{ nH}$ inductive load	$T_{vj} = 25\text{ °C}$	1090		A
			$T_{vj} = 125\text{ °C}$	1420		
Recovered charge	Q_{rr}	$V_{CC} = 1800\text{ V},$ $I_F = 1200\text{ A},$ $V_{GE} = \pm 15\text{ V},$ $R_G = 1.5\ \Omega$ $L_\sigma = 125\text{ nH}$ inductive load	$T_{vj} = 25\text{ °C}$	710		μC
			$T_{vj} = 125\text{ °C}$	1300		
Reverse recovery time	t_{rr}	$V_{CC} = 1800\text{ V},$ $I_F = 1200\text{ A},$ $V_{GE} = \pm 15\text{ V},$ $R_G = 1.5\ \Omega$ $L_\sigma = 125\text{ nH}$ inductive load	$T_{vj} = 25\text{ °C}$	560		ns
			$T_{vj} = 125\text{ °C}$	1280		
Reverse recovery energy	E_{rec}	$V_{CC} = 1800\text{ V},$ $I_F = 1200\text{ A},$ $V_{GE} = \pm 15\text{ V},$ $R_G = 1.5\ \Omega$ $L_\sigma = 125\text{ nH}$ inductive load	$T_{vj} = 25\text{ °C}$	880		mJ
			$T_{vj} = 125\text{ °C}$	1670		

⁵⁾ Characteristic values according to IEC 60747 – 2

⁶⁾ Forward voltage is given at chip level

Package properties⁷⁾

Parameter	Symbol	Conditions	min	typ	max	Unit
IGBT thermal resistance junction to case	$R_{th(j-c)IGBT}$				0.0085	K/W
Diode thermal resistance junction to case	$R_{th(j-c)DIODE}$				0.017	K/W
IGBT thermal resistance ²⁾ case to heatsink	$R_{th(c-s)IGBT}$	IGBT per switch, λ grease = $1\text{W/m}^2\text{K}$		0.009		K/W
Diode thermal resistance ⁷⁾ case to heatsink	$R_{th(c-s)DIODE}$	Diode per switch, λ grease = $1\text{W/m}^2\text{K}$		0.018		K/W
Partial discharge extinction voltage	V_e	$f = 50\text{ Hz}, Q_{PD} \leq 10\text{pC}$ (acc. to IEC 61287)	5100			V
Comparative tracking index	CTI			≥ 600		

²⁾ For detailed mounting instructions refer to ABB Document No. 5SYA2039

Mechanical properties⁷⁾

Parameter	Symbol	Conditions	min	typ	max	Unit
Dimensions	$L \times W \times H$	Typical, see outline drawing	190 × 140 × 48			mm
Clearance distance in air	d_a	according to IEC 60664-1 and EN 50124-1	Term. to base:	40		mm
			Term. to term:	26		
Surface creepage distance	d_s	according to IEC 60664-1 and EN 50124-1	Term. to base:	64		mm
			Term. to term:	56		
Mass	m			1760		g

⁷⁾ Package and mechanical properties according to IEC 60747 – 15

Electrical configuration

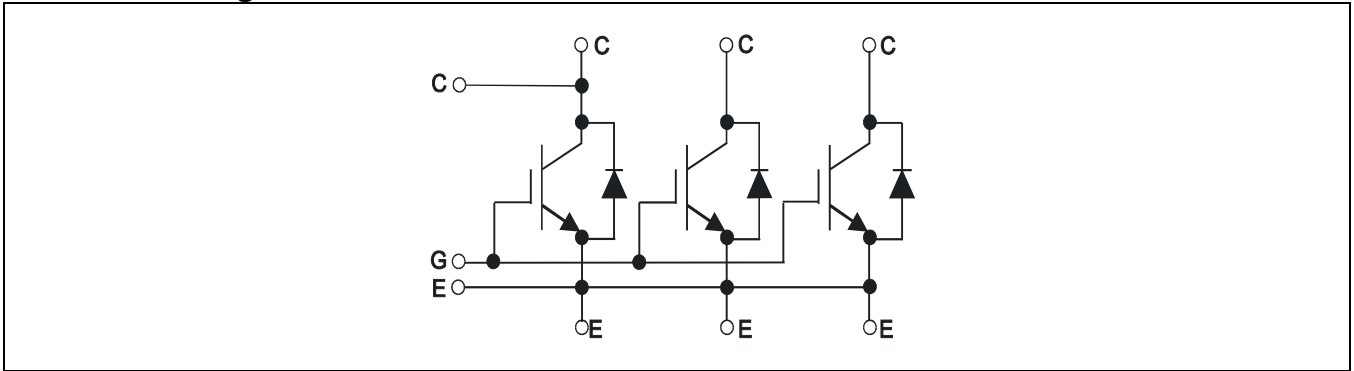

Outline drawing ²⁾

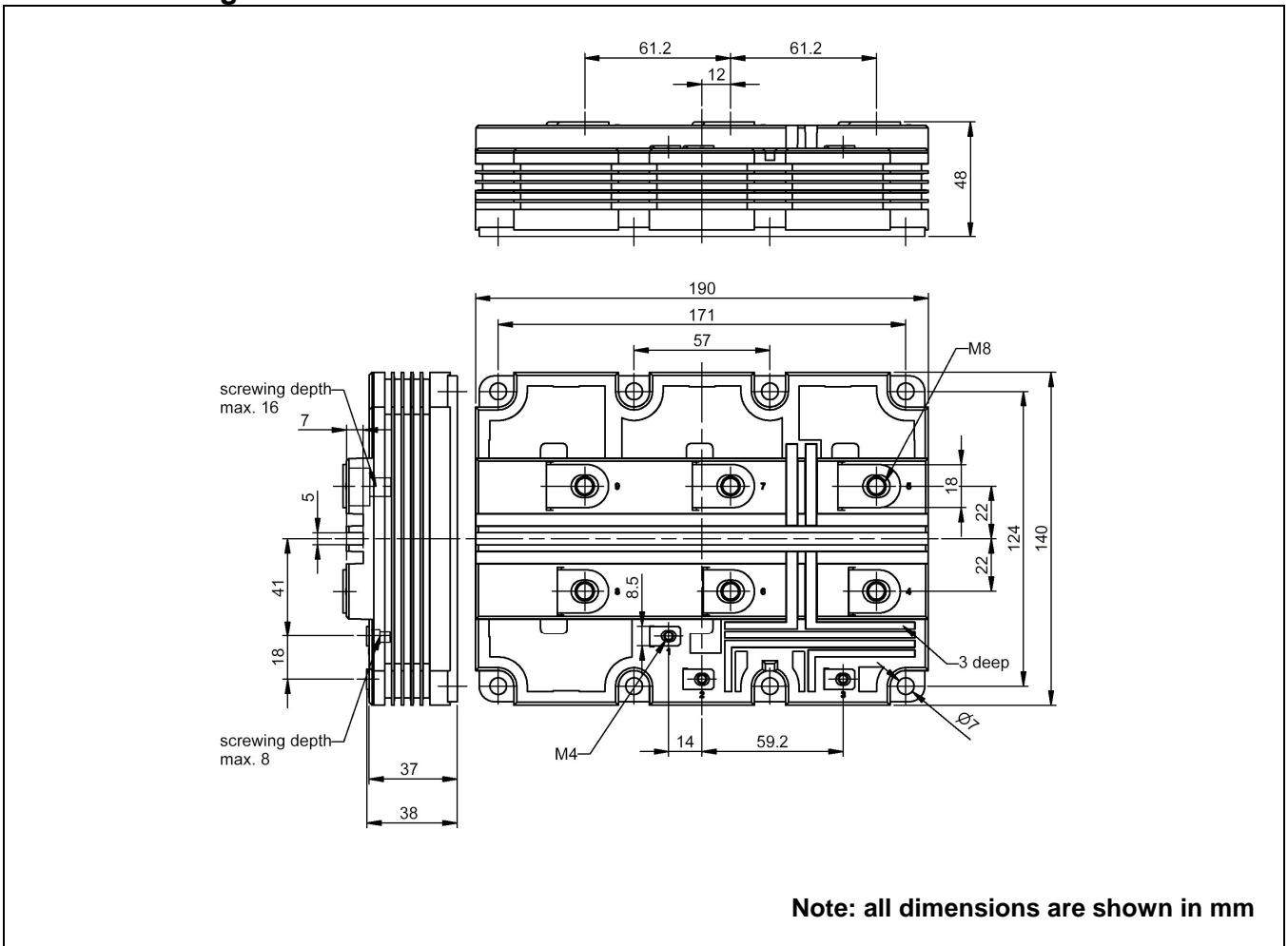

²⁾ For detailed mounting instructions refer to ABB Document No. 5SYA2039

This is an electrostatic sensitive device, please observe the international standard IEC 60747-1, chap. IX.

This product has been designed and qualified for Industrial Level.

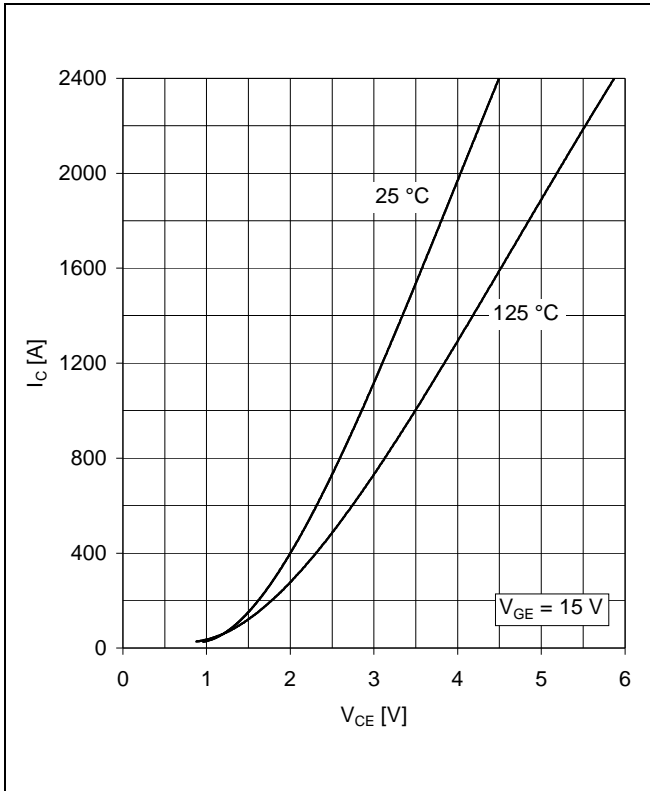

Fig. 1 Typical on-state characteristics, chip level

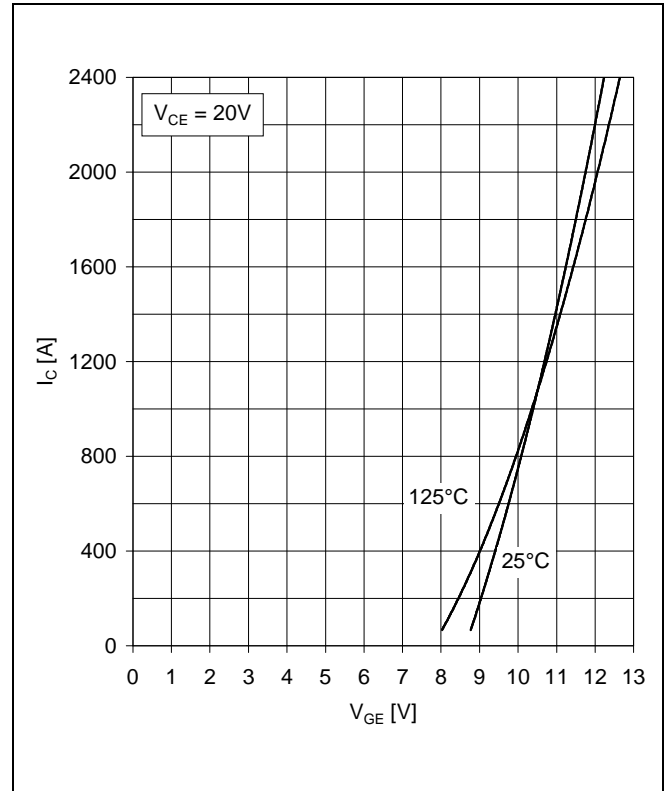

Fig. 2 Typical transfer characteristics, chip level

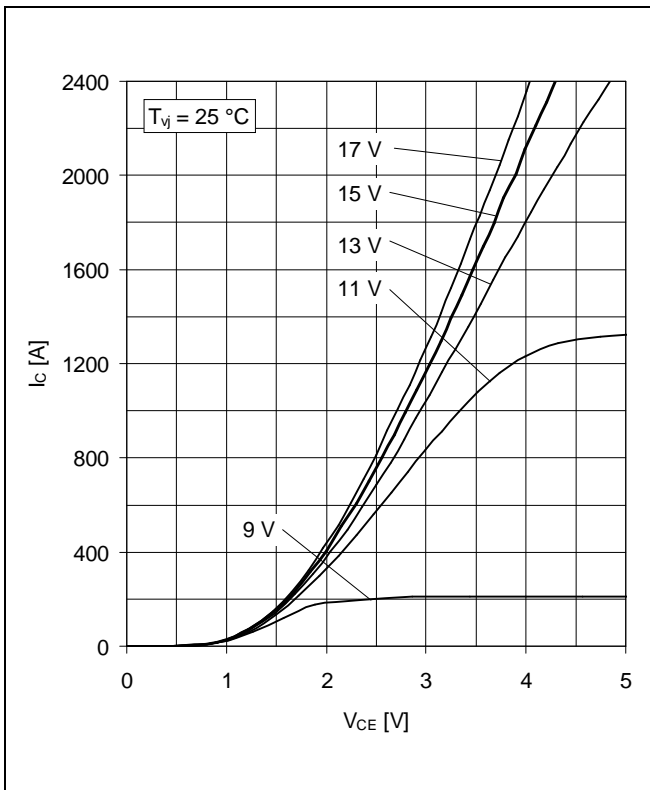

Fig. 3 Typical output characteristics, chip level

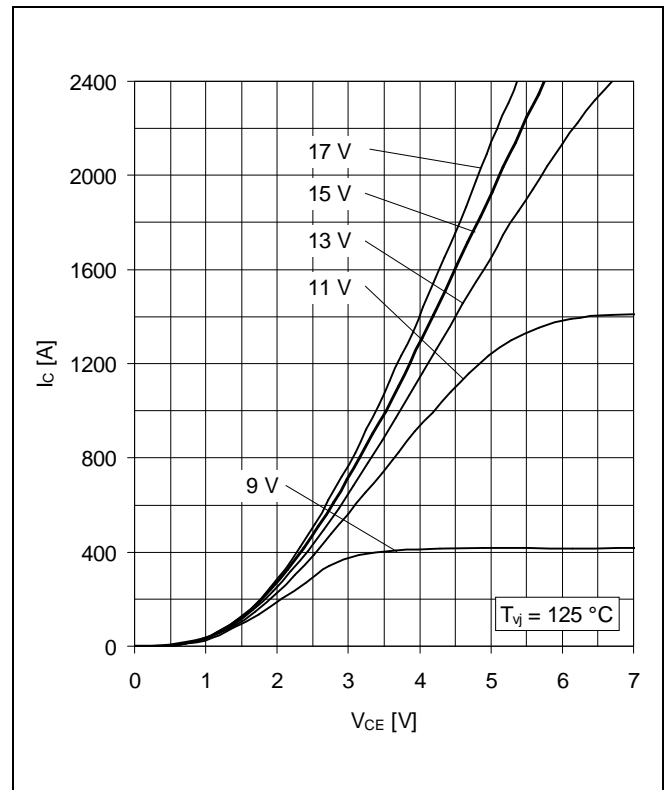

Fig. 4 Typical output characteristics, chip level

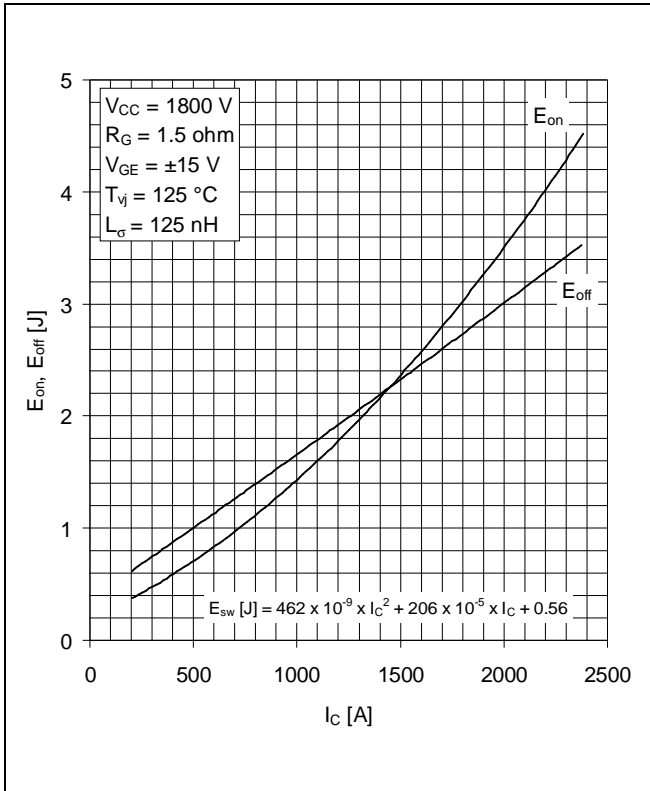

Fig. 5 Typical switching energies per pulse vs collector current

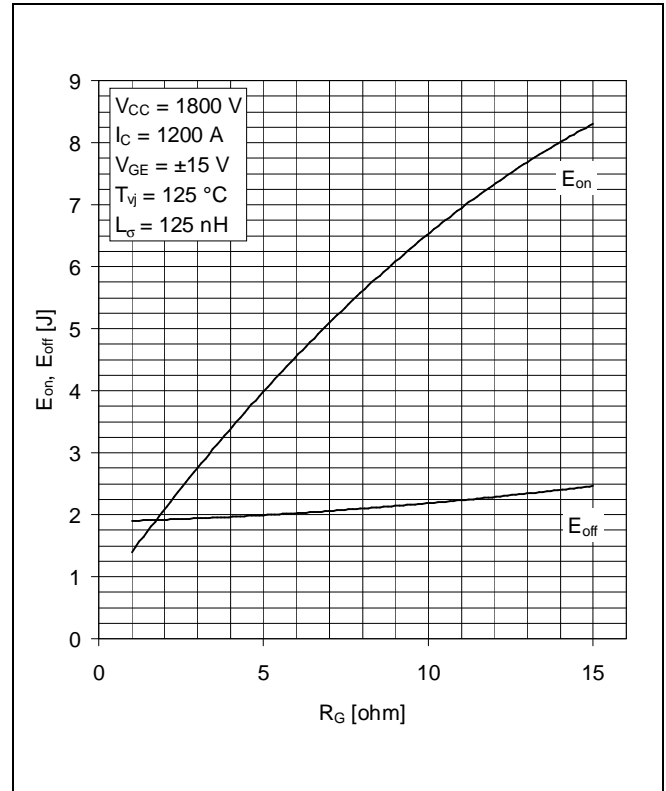

Fig. 6 Typical switching energies per pulse vs gate resistor

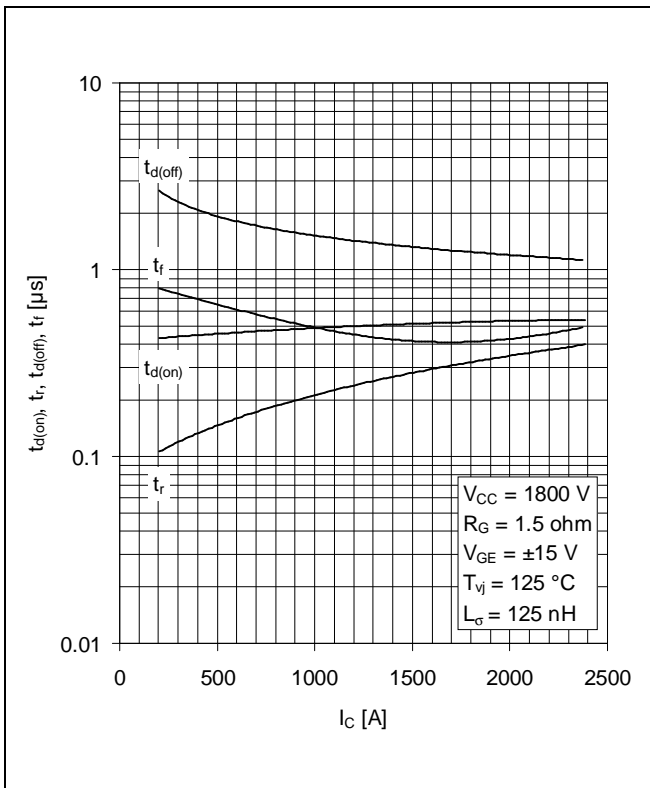

Fig. 7 Typical switching times vs collector current

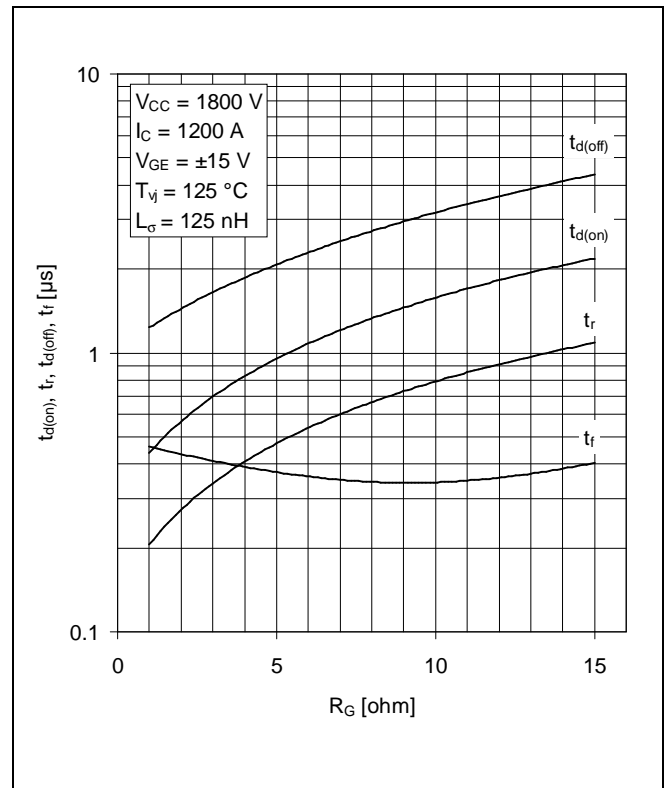

Fig. 8 Typical switching times vs gate resistor

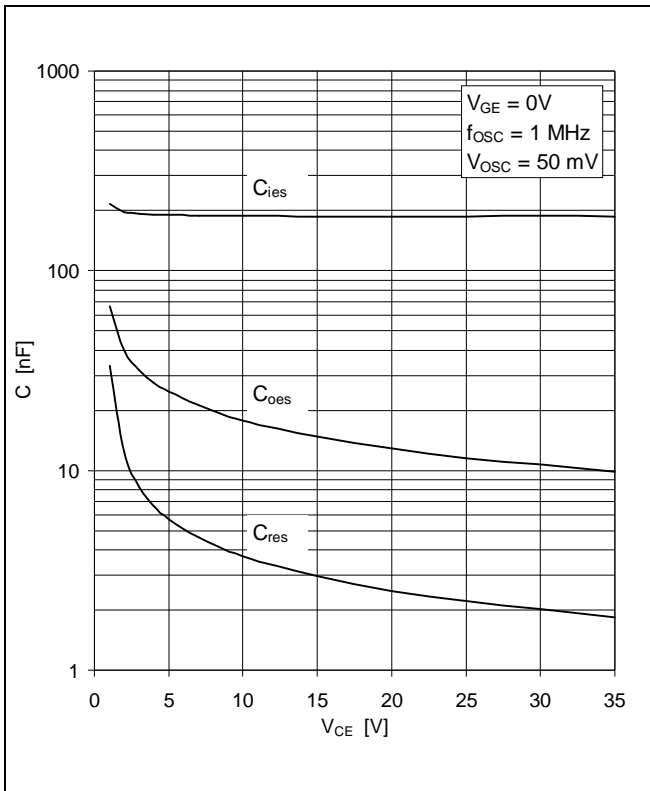

Fig. 9 Typical capacitances vs collector-emitter voltage

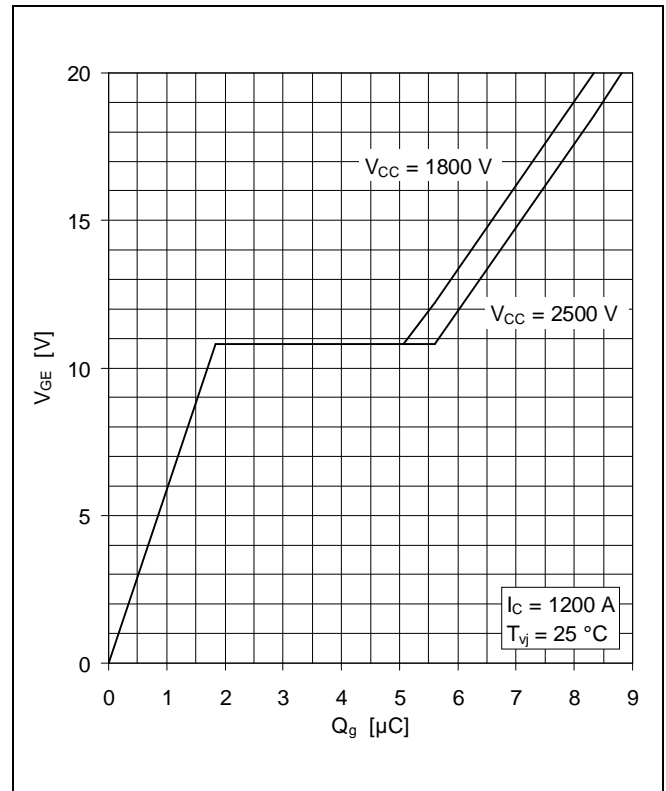

Fig. 10 Typical gate charge characteristics

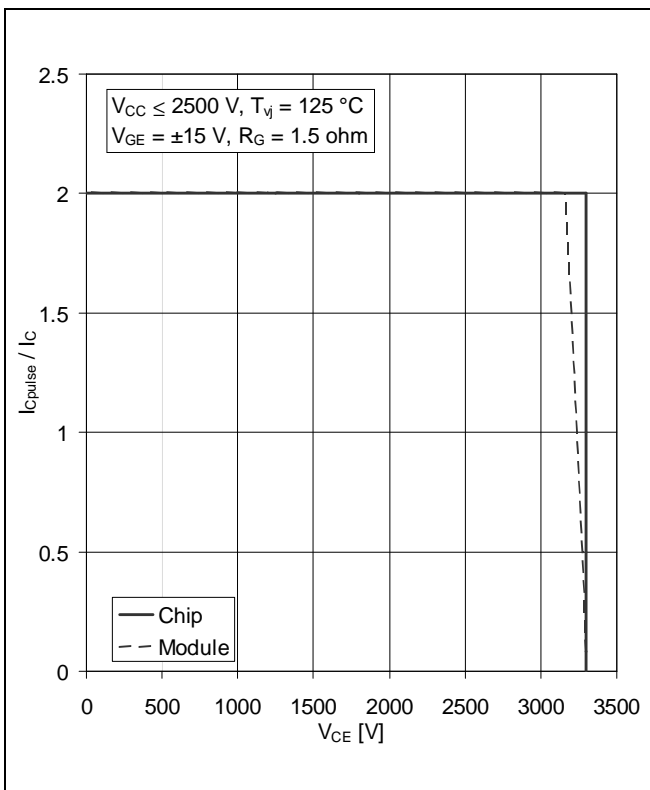

Fig. 11 Turn-off safe operating area (RBSOA)

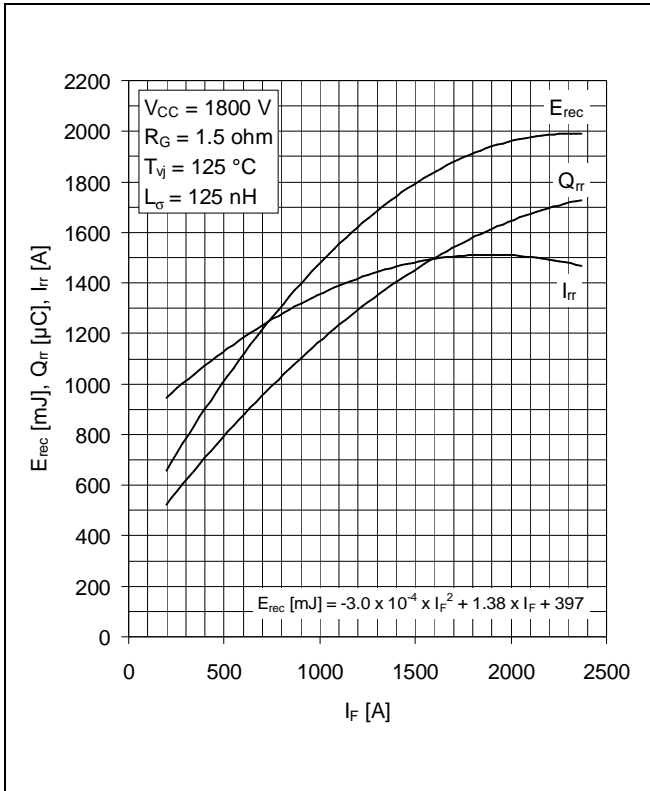

Fig. 12 Typical reverse recovery characteristics vs forward current

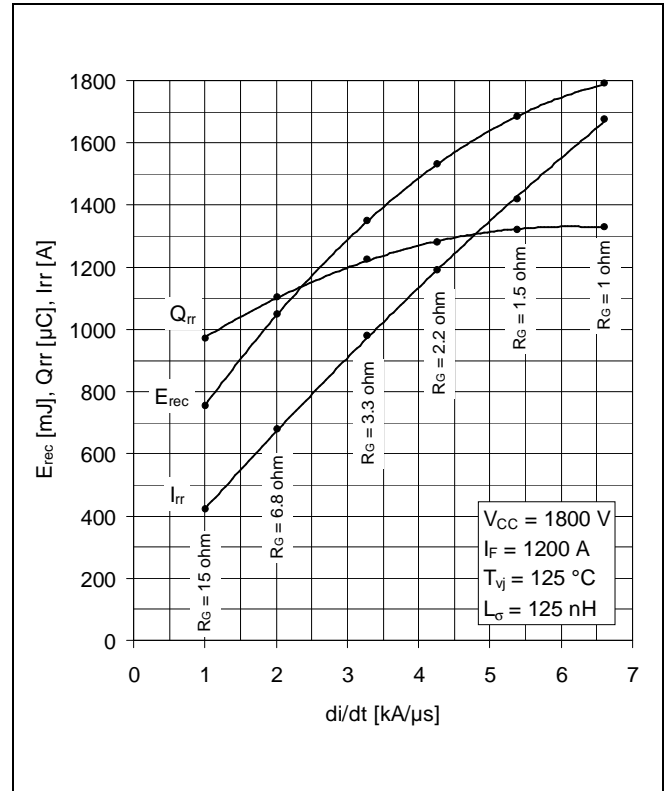

Fig. 13 Typical reverse recovery characteristics vs di/dt

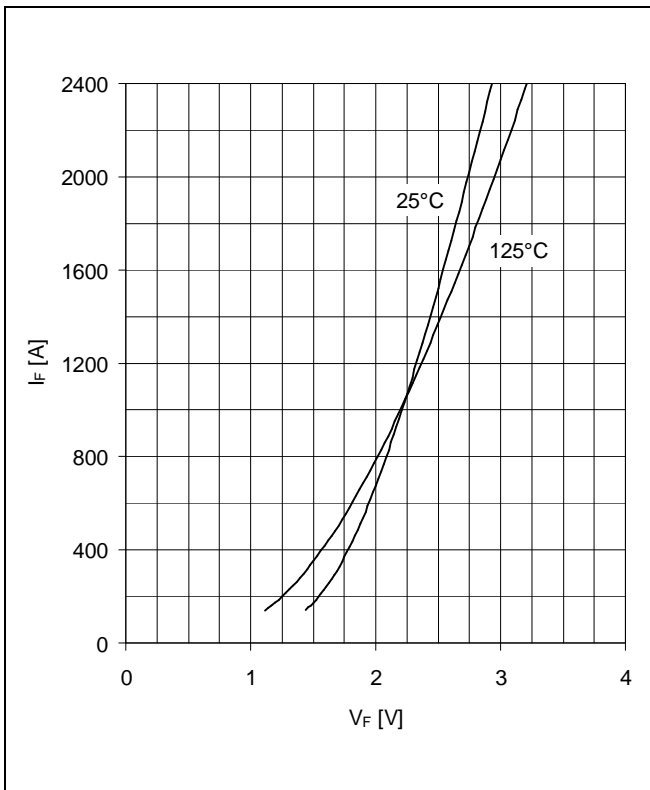

Fig. 14 Typical diode forward characteristics, chip level

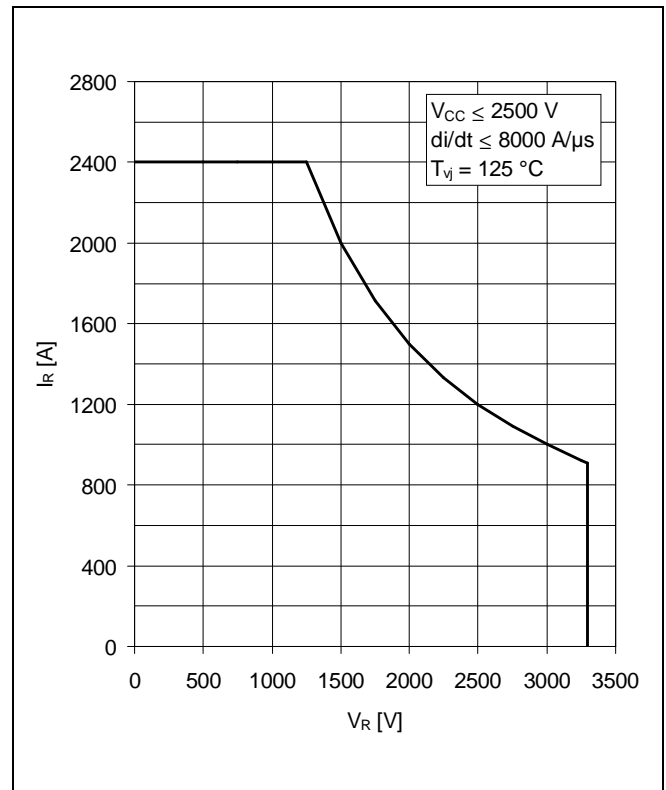

Fig. 15 Safe operating area diode (SOA)

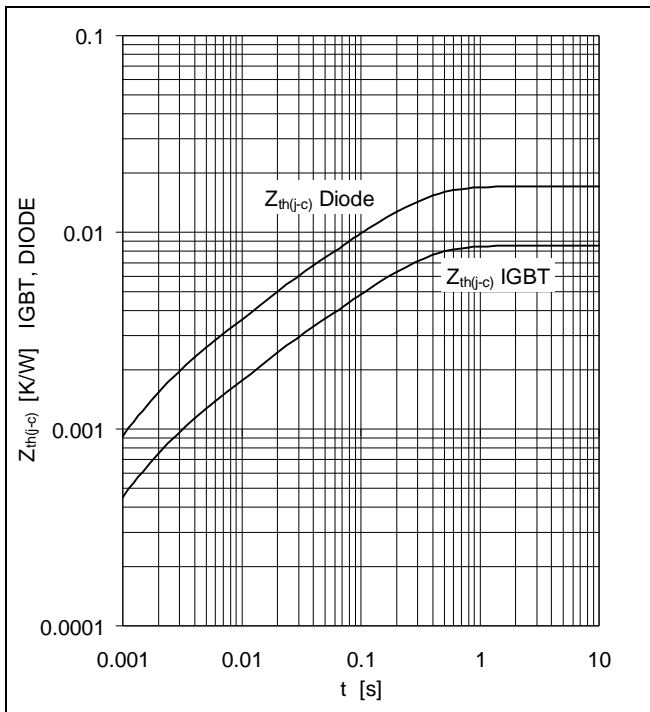

Fig. 16 Thermal impedance vs time

Analytical function for transient thermal impedance:

$$Z_{th(j-c)}(t) = \sum_{i=1}^n R_i (1 - e^{-t/\tau_i})$$

	i	1	2	3	4	5
IGBT	R _i (K/kW)	5.85	1.38	0.641	0.632	
	τ _i (ms)	207	30.1	7.55	1.57	
DIODE	R _i (K/kW)	11.5	2.89	1.23	1.3	
	τ _i (ms)	204	30.1	7.53	1.57	

For detailed information refer to:

- 5SYA 2042-02 Failure rates of HiPak modules due to cosmic rays
- 5SYA 2043-01 Load – cycle capability of HiPaks
- 5SZK 9120-00 Specification of environmental class for HiPak

ABB Switzerland Ltd, Semiconductors reserves the right to change specifications without notice.



ABB Switzerland Ltd
Semiconductors
 Fabrikstrasse 3
 CH-5600 Lenzburg, Switzerland

Doc. No. 5SYA1563-00 Apr.06

Telephone +41 (0)58 586 1419
 Fax +41 (0)58 586 1306
 Email abbsem@ch.abb.com
 Internet www.abb.com/semiconductors