

## EE-SPX613

An Ideal Photomicrosensor for  
Detecting Liquid Levels in  
Transparent Pipes

- Incorporates a Sensitivity Selector, Built-in Amplifier, and Operation Mode Selector
- Tie-wrap and rubber tube provided to prevent slippage
- Suitable for any 6- to 13-mm diameter transparent or semi-transparent pipe with a wall thickness of 1 mm
- Built-in amplifier saves space and wiring effort
- Compact size is ideal for the miniaturization of equipment
- Uses a talc-free cable that is ideal for equipment used for the manufacturing of semiconductors

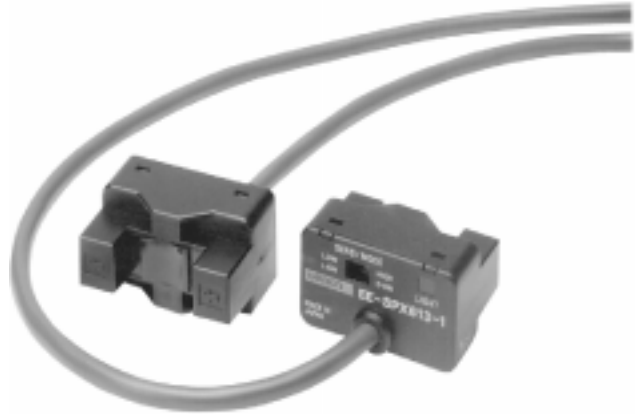

## Ordering Information

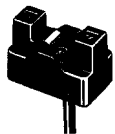
Appearance	Detection method	Output configuration	Part number
	Through-beam (with groove)	Dark-ON or light ON (selectable)	<b>EE-SPX613</b>

# Specifications

## ■ RATINGS/CHARACTERISTICS

Part Number		EE-SPX613
Power supply voltage		12 to 24 VDC $\pm 10\%$ , ripple (p-p): 5% max.
Current consumption	Average value	30 mA max.
	Peak value	80 mA max.
Applicable pipe		Any 6- to 13-mm-diameter pipe with a wall thickness of 1 mm that is made of FEP or any other material as transparent as FEP.
Sensing object		Liquids in pipes (High-viscosity liquids or liquids with floating materials may not be detected.)
Control output		Voltage: 5 to 24 VDC Load current: 100 mA max. Residual voltage: 0.8 V max. with a load current of 100 mA and 0.4 V max. with a load current of 40 mA
Indicator		Light indicator (red) (Lit with incident.)
Connection method		Pre-wired (cable length: 1 m)
Enclosure rating		IEC IP50
Ambient illumination		3,000 lx max. with incandescent light or sunlight on the receiver
Light source		Infrared LED (with a wavelength of 940 nm)
Material	Case	Polycarbonate
	Cover	
Ambient temperature	Operating	-10°C to 55°C (14°F to 131°F)
	Storage	-25°C to 65°C (-13°F to 149°F) (with no icing or condensation)
Ambient humidity	Operating	5% to 85%
	Storage	5% to 95% (with no icing or condensation)
Vibration resistance		Destruction: 10 to 500 Hz, 1.0-mm single amplitude or 150 m/s <sup>2</sup> in X, Y, and Z directions 3 times and for 11 min each
Shock resistance		Destruction: 500 m/s <sup>2</sup> in X, Y, and Z directions 3 times each

## ■ ATTACHMENTS

Supporting belt	2
Slip protection tube	2

# Nomenclature

## ■ PHYSICAL ATTRIBUTES

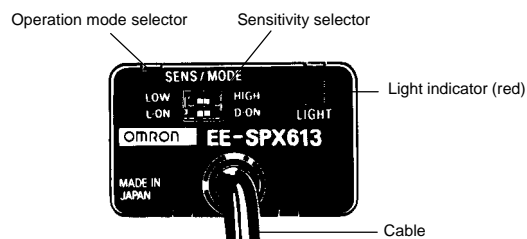

# Operation

## OUTPUT CIRCUIT

Operating status of output transistor	Dark-ON	Light-ON
Output circuit	<p>* The <math>R_L</math> is required if voltage output is required (i.e., transistor circuitry is connected).</p>	
Timing chart	<p>Light (with no liquid) Dark (with liquid)</p> <p>Light indicator (red) Lit Not lit</p> <p>Output transistor ON OFF</p> <p>Load 1 (Relay) Start Reset</p> <p>Load 2 H L</p>	<p>Light (with no liquid) Dark (with liquid)</p> <p>Light indicator (red) Lit Not lit</p> <p>Output transistor ON OFF</p> <p>Load 1 (Relay) Start Reset</p> <p>Load 2 H L</p>

## OPERATION

The EE-SPX613 detects the level of liquid by detecting the difference in refractive index between the air and liquid.

1. If there is no liquid in the pipe, the emitted beam will reach the receiver after it is refracted by the pipe.

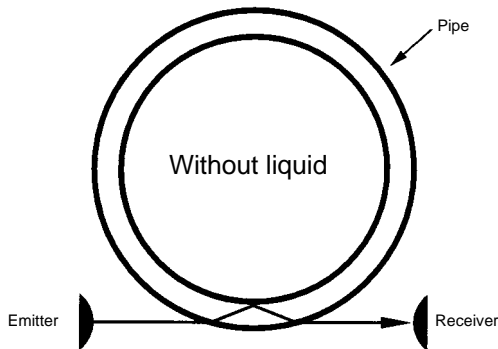

2. If there is liquid in the pipe, the emitted beam will pass through the liquid and not reach the receiver.

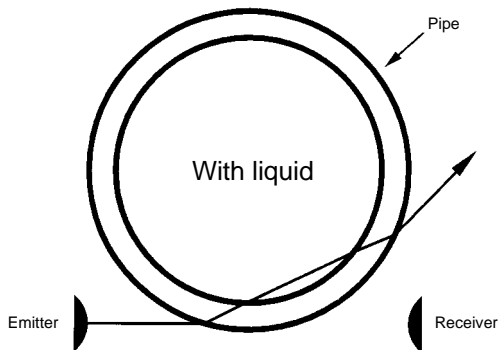

If the diameter of the pipe is close to 6 mm, some of the emitted light may reach the receiver because the angle of refraction is small. This may result in false readings. In such cases, set the sensitivity selector to Low and check that the EE-SPX613 reads correctly for pipes with and without liquid.

If there are floating materials on the surface of the liquid, light reflected from the floating material may reach the receiver. In such cases, set the sensitivity selector to Low and check the operation of the EE-SPX613 for pipes with and without liquid.

If transmission of the light is impaired by stains on the pipe or an emitter that has deteriorated with age, you may need to set the sensitivity to HIGH.

## Dimensions

Unit: mm

### ■ EE-SPX613

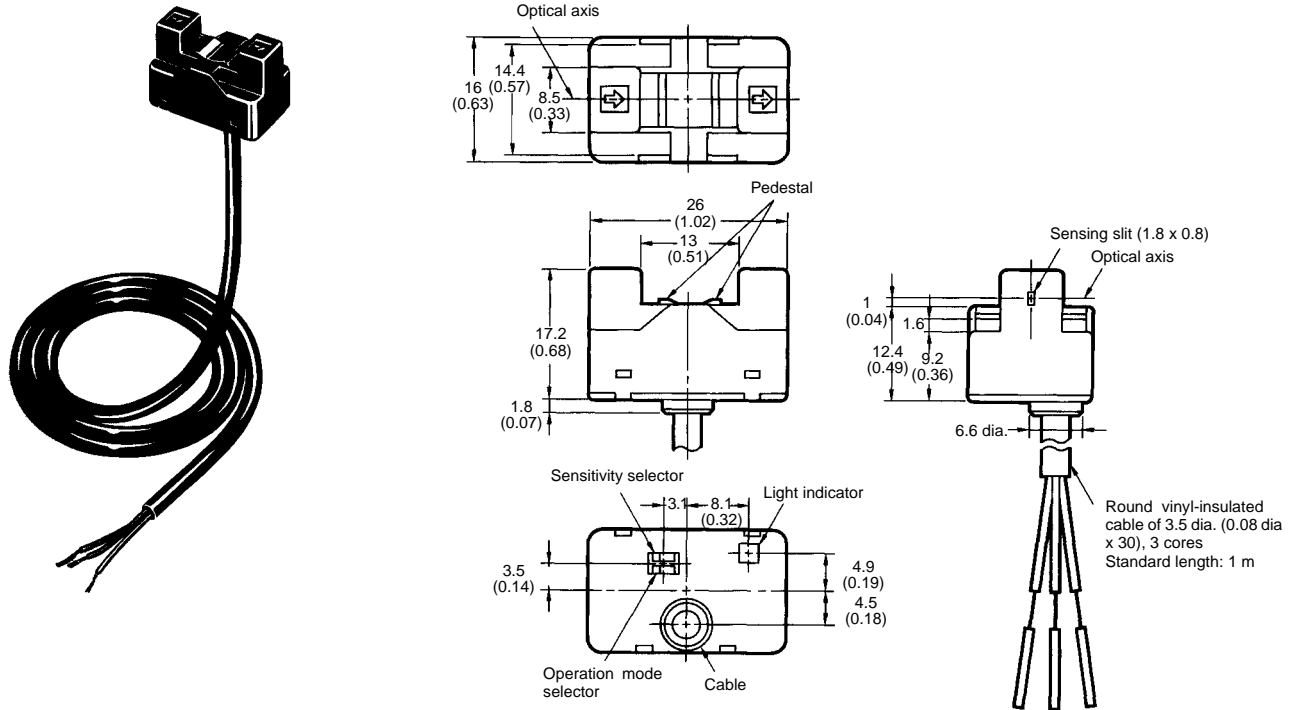

## Precautions

### ⚠ WARNING

- Do not supply or impose on the EE-SPX613 any AC current or voltage exceeding the upper limit of the rated voltage range, or the EE-SPX613 may be damaged.
- Do not short-circuit the load connected to the EE-SPX613, or the EE-SPX613 may be damaged.

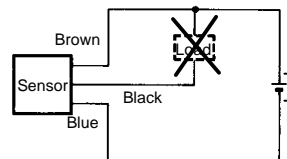
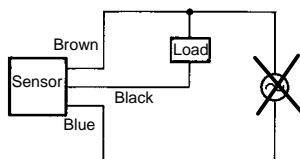

- Incorrect polarity resulting from wrong wiring or connections may result in injury to the user or damage to the equipment.

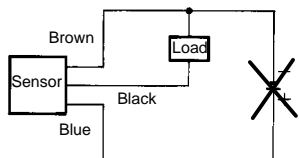

## ⚠ Caution

### Mounting

Always use supporting belts and slip protection tubes, which are provided with the EE-SPX613, when attaching the EE-SPX613 to an appropriate pipe, as shown in the following illustration. Make sure that the pipe is in the center of the sensor groove and not lifted from the pedestal.

When tightening the supporting belts, make sure that the pipe will not be deformed.

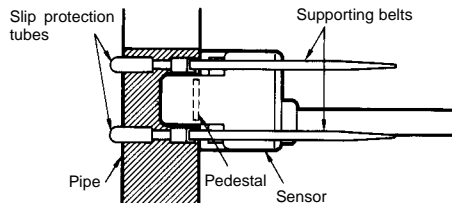

### Power Supply

Ground the FG and GND terminals if a standard switching regulator is used to supply power to the EE-SPX613, or the EE-SPX613 may malfunction.

### Operating Environment

The EE-SPX613 is not watertight. Do not use the EE-SPX613 outdoors.

Do not use the EE-SPX613 in places where water, oil, or chemicals may splash or be sprayed onto the unit.

The exterior coverings of the EE-SPX613 are made of polycarbonate. Keep the coverings away from any alkaline, aromatic hydrocarbon, or aliphatic chloride hydrocarbon solvent, all of which will damage the coverings.

### Others

- The EE-SPX613 requires 10 ms to be in stable operation after power is supplied.  
If two power supplies are used for the EE-SPX613 and load respectively, be sure to supply power to the EE-SPX613 before supplying power to the load.
- If there is a high-tension line near the cable, wire the cable through an independent metal conduit to protect the EE-SPX613 from damage or malfunction.
- Do not attach the EE-SPX613 to improper pipes, such as non-transparent pipes, or the EE-SPX613 may not operate properly.
- Do not impose any excessive force on the cable.  
Do not pull the cable with a force exceeding 30 N.
- Use an extension cable with conductors having a total cross-sectional area of 0.15 mm<sup>2</sup> (i.e., AWG26) and a total cable length of 5 m maximum.
- Do not impose a force exceeding 5 N on the operation mode selector or sensitivity selector.

**NOTE: DIMENSIONS SHOWN ARE IN MILLIMETERS. To convert millimeters to inches divide by 25.4.**

# OMRON®

**OMRON ELECTRONICS, INC.**

One East Commerce Drive  
Schaumburg, IL 60173

**1-800-55-OMRON**

**OMRON CANADA, INC.**

885 Milner Avenue  
Scarborough, Ontario M1B 5V8

**416-286-6465**