

Power Relay RM C/D

- 1 pole 30 A, 1 NO or 1 NO + 1 NC contact
- Switching capacity up to 7500 VA
- DC- or AC-coil
- Push-to-test-button
- Chassis mount
- RoHS compliant (Directive 2002/95/EC) as per product date code 0415

Applications

Battery chargers, heating control



F0166-A

Approvals

UL E214025

Technical data of approved types on request

Contact data	RMC	RMD
Contact configuration	1 NO and 1 NC	1 NO
Contact set	single bridging contact	
Type of interruption	micro disconnection	
Rated current	30 A	
Rated voltage / max.switching voltage AC	400/440 VAC	
Maximum breaking capacity AC	7500 VA	
Limiting making capacity, max 20 ms	60 A	
Contact material	AgCdO	
Mechanical endurance	10x10 ⁶ cycles	
Rated frequency of operation with / without load	16/100 min ⁻¹	

Contact ratings

Type	Load	Cycles
RMC/D	30 A, 415 VAC, UL	10x10 ³
RMC/D	30 A, 250 VAC, general purpose, UL	6x10 ³

Coil data

Rated coil voltage range	DC coil	6...220 VDC
	AC coil	6...400 VAC
Coil power	DC coil	1.2 W
	AC coil	2.8 VA
Operative range	1	

Coil versions, DC-coil

Coil code	Rated voltage VDC	Operate voltage VDC	Release voltage VDC	Coil resistance Ohm	Rated coil power W
STD LED PD* bipolar	LED+ PD*				
006 L06 OA6 LA6	6	4.5	0.6	32±10%	1.1
012 L12 OB2 LB2	12	9.0	1.2	110±10%	1.3
024 L24 OC4 LC4	24	18.0	2.4	475±10%	1.2
048 L48 OE8 LE8	48	36.0	4.8	2000±10%	1.2
060 L60 OG0 LG0	60	45.0	6.0	2850±10%	1.3
110 M10 I10 MB0	110	82.5	11.0	10000±12%	1.2
221 N21 2C1 NC1	220	165.0	22.0	40000±15%	1.2

All figures are given for coil without preenergization, at ambient temperature +23°C

*) Protection diode PD; standard polarity: +A1 / -A2

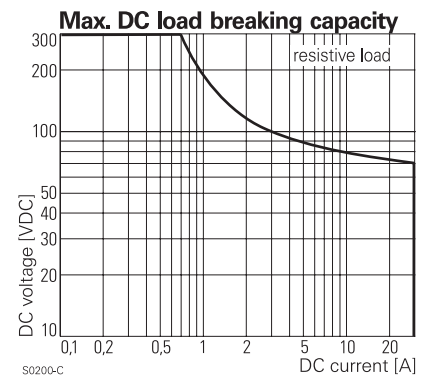

S0200-C

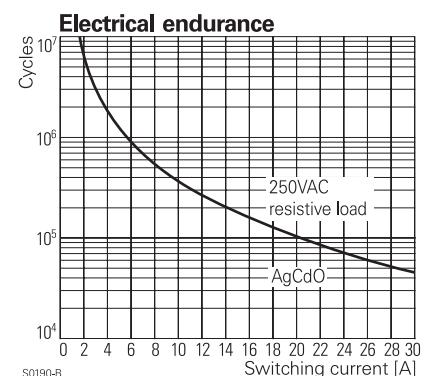

S0190-B

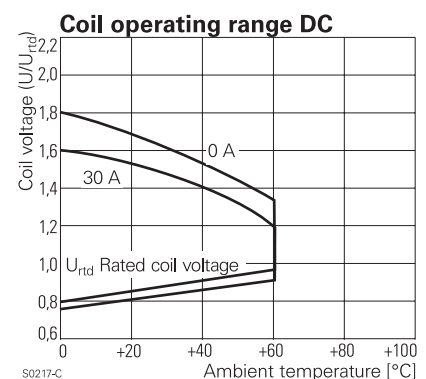

S0217-C

Coil versions, AC-coil 50/60 Hz

Coil code	LED	Rated voltage	Operate voltage	Release voltage	Coil resistance	Rated coil power
STD	LED	VAC	50/60Hz VAC	50/60Hz VAC	Ohm	50/60Hz VA
524	R24	24	19.2	9.6	80±10%	2.62/2.00
548	R48	48	38.4	19.2	320±10%	2.60/2.17
560	R60	60	48.0	24.0	500±10%	2.62/2.20
615	S15	115	92.0	46.0	1850±10%	2.65/2.22
730	T30	230	184.0	92.0	7500±10%	2.69/2.26
900	V00	400	320.0	160.0	23500±15%	2.61/2.20

All figures are given for coil without preenergization, at ambient temperature +23°C

Insulation

Dielectric strength coil-contact circuit	2500 V _{rms}
open contact circuit	1500 V _{rms}
Clearance / creepage coil-contact circuit	≥ 4/14.9 mm
Material group of insulation parts	≥ IIIa
Insulation to IEC 60664-1	
Type of insulation coil-contact circuit	basic
open contact circuit	functional
Rated insulation voltage	250 V
Pollution degree	3
Rated voltage system	240/400 V
Overvoltage category	III

Other data

RoHS - Directive 2002/95/EC	compliant as per product date code 0415
Ambient temperature range DC coil	-45...+60°C
AC coil	-45...+40°C
Operate- / release time	17/18 ms
Bounce time NO / NC contact	4
Vibration resistance (function) NO / NC contact	10/5 g, 30...150 Hz
Category of protection	RTI - dust protected
Relay weight	81 g
Packaging unit	10 pcs

Terminal assignment

Bottom view on pins

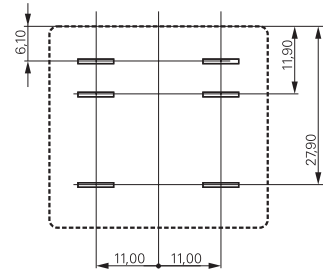

S0269-AK

1 NO and 1 NC contact, RMC

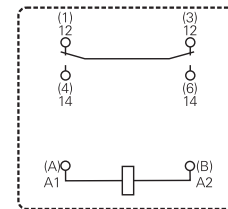

S0269-AH

1 NO contact, RMD

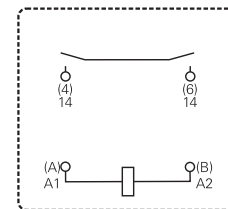

S0269-AI

Power Relay RM C/D (Continued)

Dimensions

Cover with mounting brackets, 6.3 mm quick connect terminals

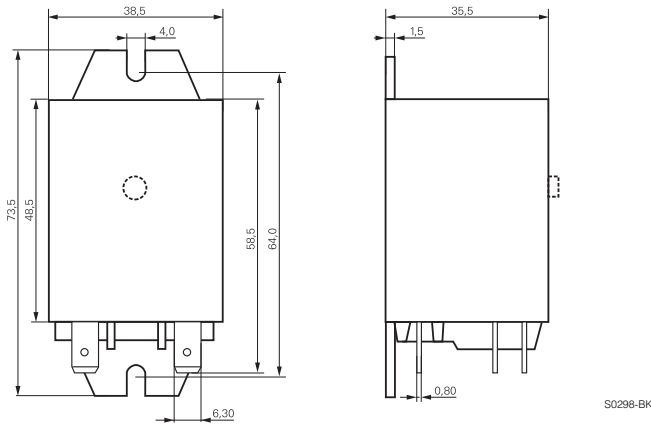

Product key



Type

Contact configuration

- C** 1 NO contact and 1 NC contact, 30 A
- D** 1 NO contact, 30 A

Version

- 0** AgCdO, without test button
- 3** AgCdO, with test button

Enclosure

- 5** cover with mounting brackets, 6.3 mm quick connect terminals

Coil

Coil code: please refer to coil versions table, preferred types in bold print

Product key	Contacts	Version	Enclosure	Coil	Coil	Part number
RMC05024	1 NO + 1 NC contact 30 A	without	mounting brackets	DC-coil	24 VDC	4-1393844-5
RMC05524		test button		AC-coil	24 VAC	0-1393146-5
RMC05615					115 VAC	8-1393147-7
RMC05730					230 VAC	0-1393146-6
RMC35024		with test button		DC-coil	24 VDC	0-1393146-7
RMD05024	1 NO contact 30 A	without			24 VDC	0-1393146-9
RMD05524		test button		AC-coil	24 VAC	1-1393146-1
RMD05615					115 VAC	0-1415009-1
RMD05730					230 VAC	4-1393844-7
RMD35024		with		DC-coil	24 VDC	2-1419136-2
RMD35730		test button		AC-coil	230 VAC	0-1393097-5