

power light source

# LUXEON® Flash

## Introduction

LUXEON® Flash is a family of ultra-compact light sources specifically designed and tested for use as a camera flash in space-constrained, portable digital imaging applications. The LUXEON Flash products are based on proven LUXEON technology and provide the highest levels of light output available for a solid state light source. The uniquely bright source density characteristics of the LUXEON Flash products will provide greater amounts of light where needed, enabling higher resolution pictures to be taken in lower level ambient light environments at greater distances. Camera cell phones, digital still cameras and PDAs can all incorporate LUXEON Flash into sleek designs while maintaining high levels of light output.



## Features

- ♦ Highest brightness LED flash
- ♦ Very small emitter size
- ♦ Radiation patterns optimal for Camera Flash (with lens)
- ♦ Smaller than Xenon Strobe Light
- ♦ Surface mount technology
- ♦ Superior ESD protection

## Benefits

- ♦ Intense illumination and long distance (up to 2m)
- ♦ Enables higher resolution pictures in darker environments
- ♦ Small emitter size allows for smaller overall package size

## Typical Applications

- ♦ Camera-phones
- ♦ Digital still cameras
- ♦ PDAs

## Mechanical Dimensions

### LXCL-PWF1 and LXCL-PWF3

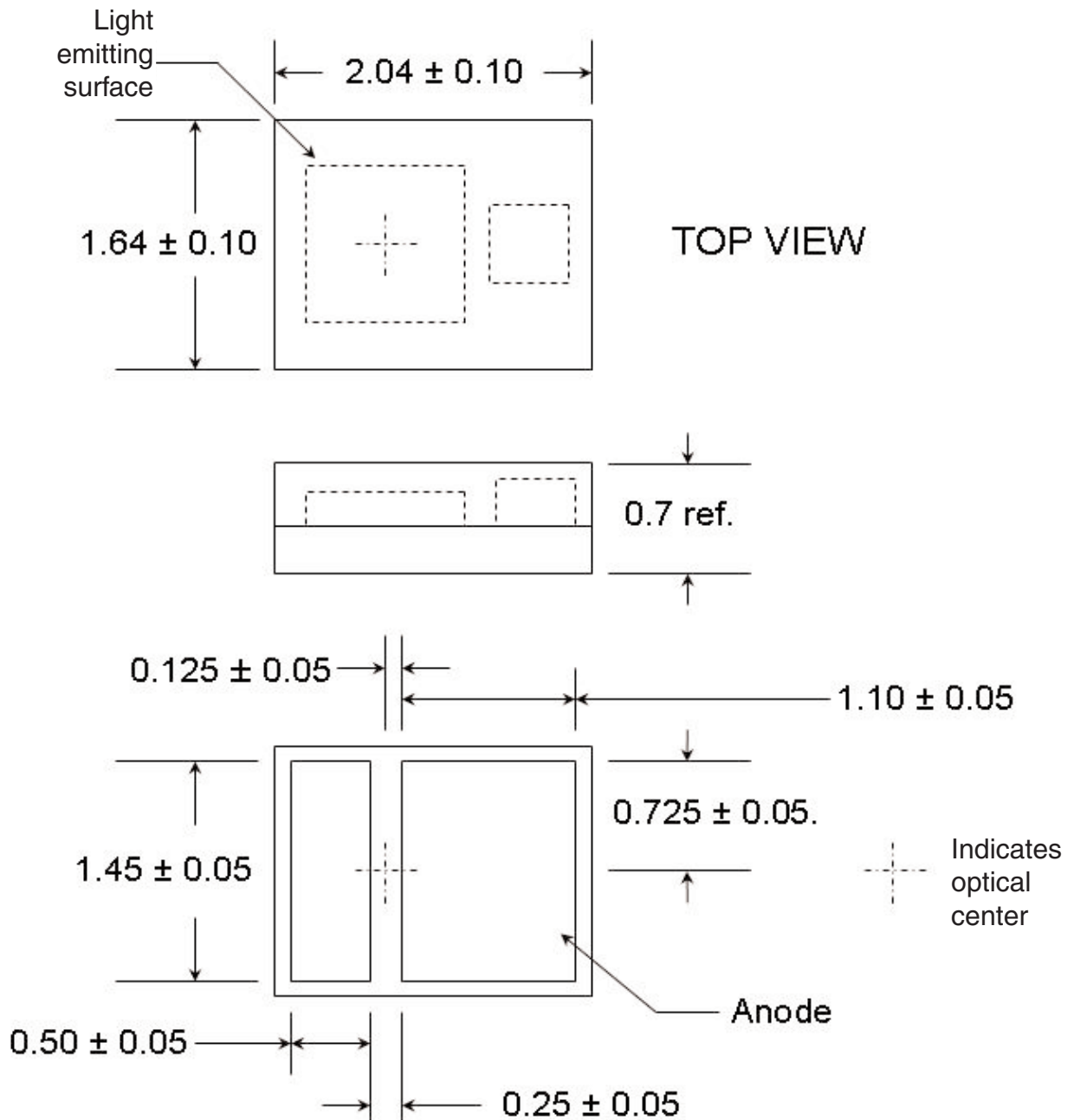

#### Notes:

1. Drawings not to scale.
2. All dimensions are in millimeters.
3. Measurements without tolerances are for reference only.

## Flux Characteristics at 1000mA<sup>[1] [2]</sup>, Junction Temperature, $T_J = 25^\circ\text{C}$

Table 1.

Part Number	Current (mA)	Minimum Luminous Flux ( $\text{lm}$ )	Typical Luminous Flux ( $\text{lm}$ )
		$\Phi_V$	$\Phi_V$
LXCL-PWF1	1000	36	53
LXCL-PWF3	1000	50	73

## Electrical Characteristics at 1000mA<sup>[3]</sup>, Junction Temperature, $T_J = 25^\circ\text{C}$

Table 2.

Part Number	Current (mA)	Forward Voltage $V_F$ (V)		
		Min.	Typ.	Max.
LXCL-PWF1	1000	3.2	3.8	4.8
LXCL-PWF3	1000	3.0	3.6	4.6

## Typical Flux ( $\text{lm}$ ) Output vs. Drive Current<sup>[4] [5]</sup>

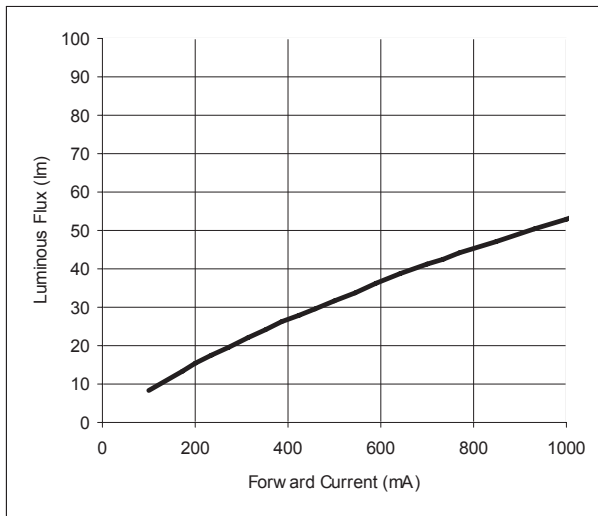

Figure 1. LXCL-PWF1.

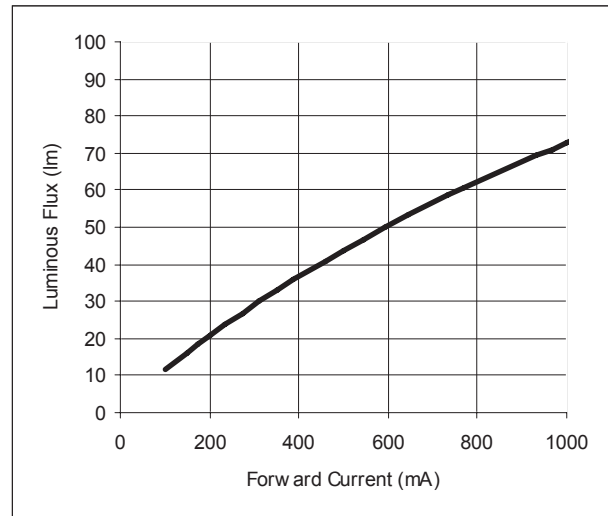

Figure 2. LXCL-PWF3.

Notes for Tables 1 and 2 and Figures 1 and 2:

1. Minimum luminous flux performance guaranteed within published operating conditions. Philips Lumileds maintains a tolerance of  $\pm 10\%$  on flux measurements.
2. LUXEON types with even higher luminous flux levels will become available in the future. Please consult your Philips Lumileds Authorized Distributor or Philips Lumileds sales representative for more information.
3. Philips Lumileds maintains a tolerance of  $\pm 0.06\text{V}$  on forward voltage measurements.
4. All values assume a junction temperature  $T_J$  of  $25^\circ\text{C}$ .
5. For flash modes, it is recommended that the drive current be as high as possible (up to 1000 mA) for optimal results.

## Flash and Torch Mode Operation

### Typical Axial Intensity (cd) and Illuminance (lux) vs. Drive Current, $T_J = 25^\circ\text{C}$

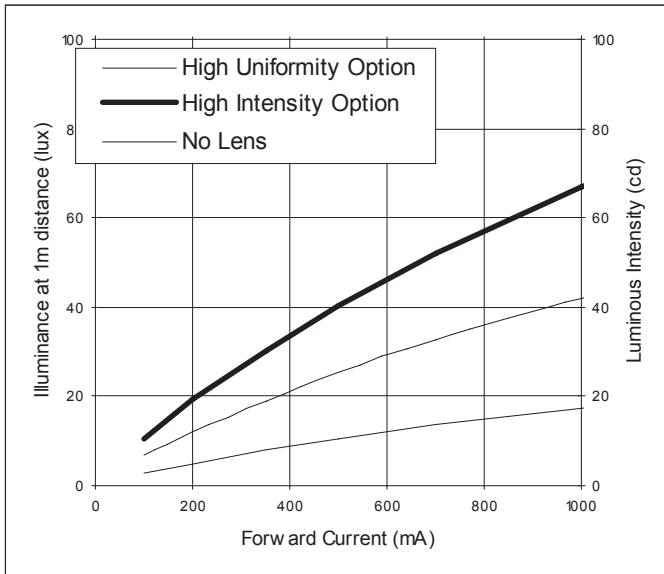

Figure 3. LXCL-PWF1.

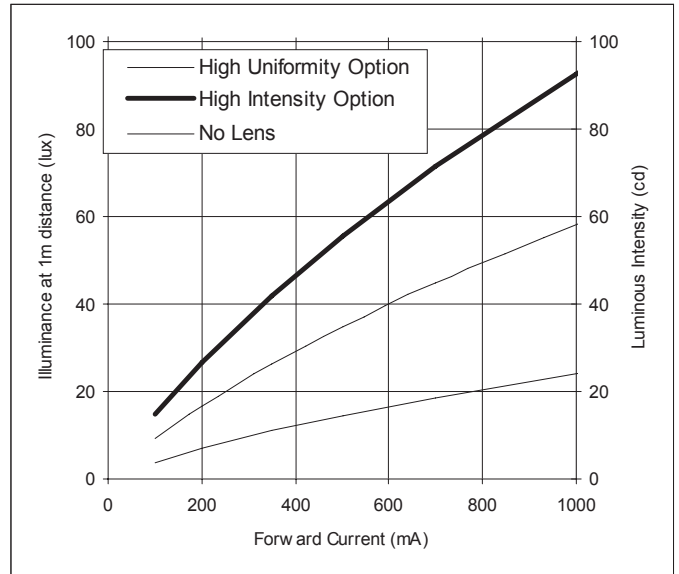

Figure 4. LXCL-PWF3.

Notes for Figures 3 and 4:

1. High Uniformity and High Intensity Options assume use of the Philips Lumileds reference design optic. The design of this optic is available upon request.

High Uniformity option is achieved by placing the lens at 0.4 mm from the top of the emitter. This will yield uniformity of 41% (relative to the center) at the horizontal edge and 24% (relative to the center) at the corners.

Uniformity can be traded-off for increased On-Axis Illuminance/Intensity. This is shown in the High Intensity Option and is achieved by placing the optic at 0.7mm from the top of the emitter. In this option, the uniformity is 17% at the horizontal edge and 10% at the corners.

2. Illuminance is inversely proportional to the square of the distance.

For example: if the illuminance at 1 meter is 40, then the illuminance at 2 meters is  $40/(2^2) = 10$  lux.

The illuminance at 3 meters is  $40/(3^2) = 4.4$  lux

3. For flash modes, it is recommended that the drive current be as high as possible for optimal results.

## Color Temperature (White) for Flash & Torch Modes

Table 3.

Color Temperature - CCT			Total Included Angle <sup>[1]</sup> (degrees) $\theta_{0.90V}$	Viewing Angle <sup>[2]</sup> (degrees) $2\theta_{1/2}$
Min	Typ	Max		
5000K	6500K	10000K	140	120

Notes for Table 3:

1. Total included angle at which 90% of total luminous flux is captured.
2.  $\theta_{1/2}$  is the off axis angle from lamp centerline where the luminous intensity is  $1/2$  of the peak value.
3. Tolerance of x, y color coordinates is +/- 0.005.

## Typical Forward Voltage ( $V_F$ ) vs. Drive Currents ( $I_F$ ) for Both Flash & Torch Modes Junction Temperature $T_J = 25^\circ\text{C}$

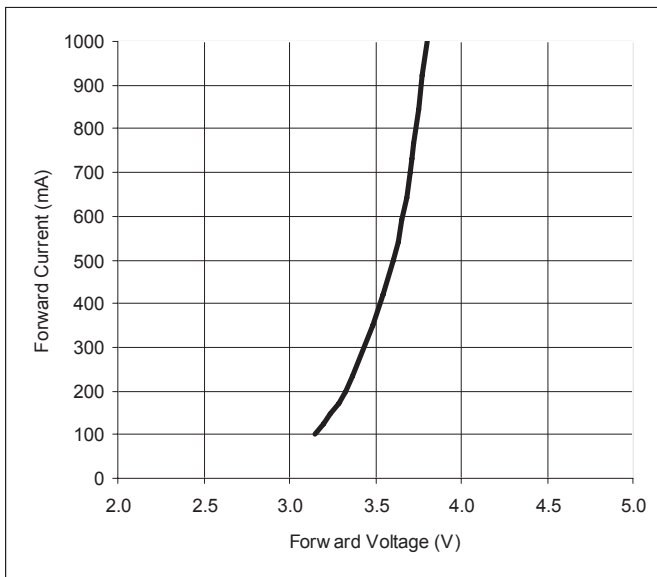

Figure 5. Forward Voltage vs. Drive Current for LXCL-PWF1.

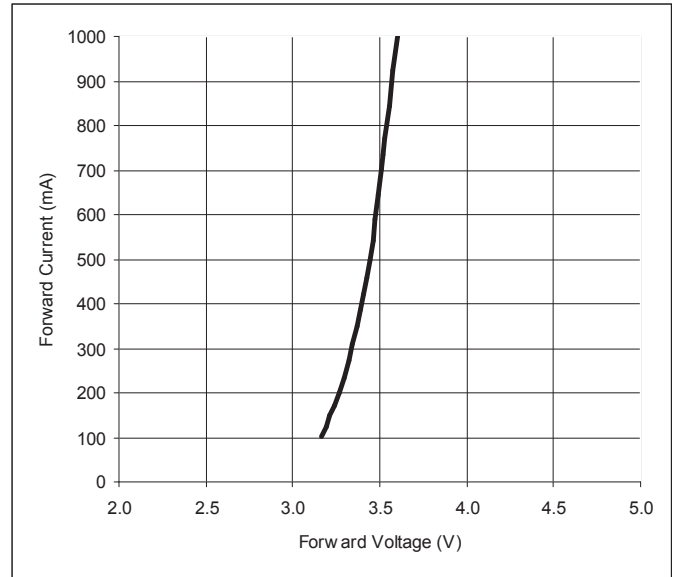

Figure 6. Forward Voltage vs. Drive Current for LXCL-PWF3.

## Typical Electrical & Thermal Characteristics

Table 4.

Part Number	Dynamic Resistance <sup>[1][2]</sup> ( $\Omega$ ) $R_D$	Temperature Coefficient of Forward Voltage <sup>[2]</sup> (mV/ $^\circ\text{C}$ ) $\Delta V_F / \Delta T_J$	Thermal Resistance, Junction to Case ( $^\circ\text{C/W}$ ) $R_{\theta J-C}$
LXCL-PWF1	0.2	-2.0	9.3
LXCL-PWF3	0.2	-2.0	13

Notes for Table 4:

1. Dynamic resistance is the inverse of the slope in linear forward voltage model for LEDs.
2. Measured between  $25^\circ\text{C} \leq T_J \leq 110^\circ\text{C}$  at  $I_F = 1000\text{mA}$ .

## Absolute Maximum Ratings LXCL-PWF1 and LXCL-PWF3

Table 5.

Parameter	Value
Max DC Operating Current (mA)	350
Peak Pulsed Forward Current (mA)	1000
ESD Sensitivity <sup>[1]</sup>	JEDEC Class 3b (8kV)
LED Case Temperature (°C) <sup>[2]</sup>	85
Storage Temperature (°C)	-40 to +120
Reflow Soldering Temperature (°C)	260 for 5 seconds max
Operating Temperature (°C)	-40 to +85

Notes for Table 5:

1. LEDs are not designed to be driven in reverse bias. Philips Lumileds does not guarantee at reverse bias conditions.
2. Temperature of the board measured at location close to soldered LED.

### Max Pulse $I_f$ vs. T-case

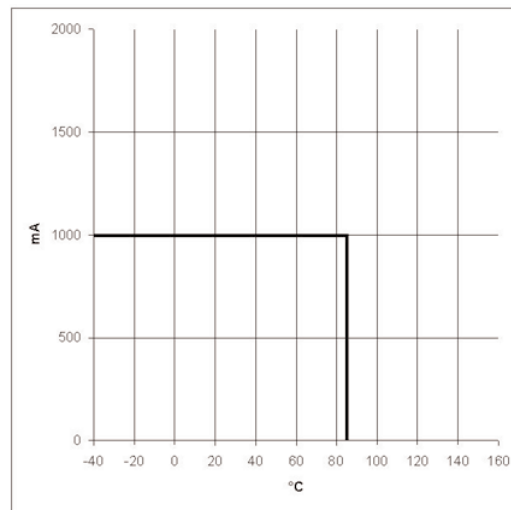

Figure 7. LXCL-PWF1 and LXCL-PWF3.

### Max DC $I_f$ vs. T-case

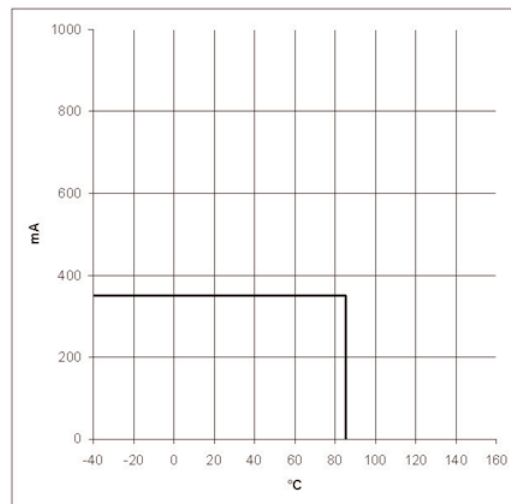

Figure 8. LXCL-PWF1 and LXCL-PWF3.

## Typical Wavelength Characteristics, $T_J = 25^\circ\text{C}$

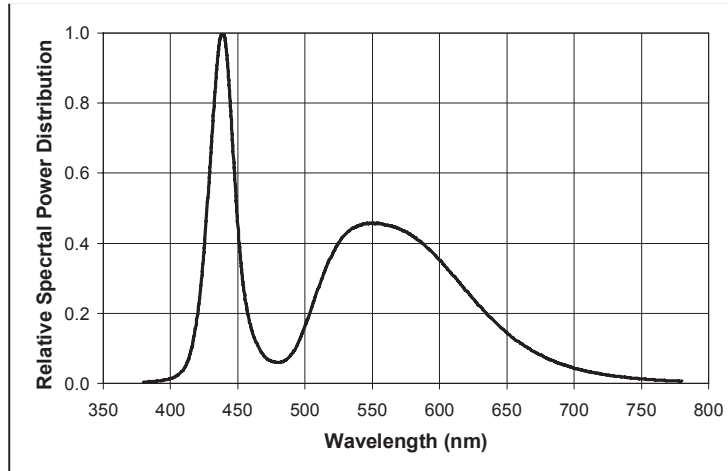

Figure 9. White Color Spectrum of Typical CCT Part, Integrated Measurement.

## Typical Representative Spatial Radiation Pattern

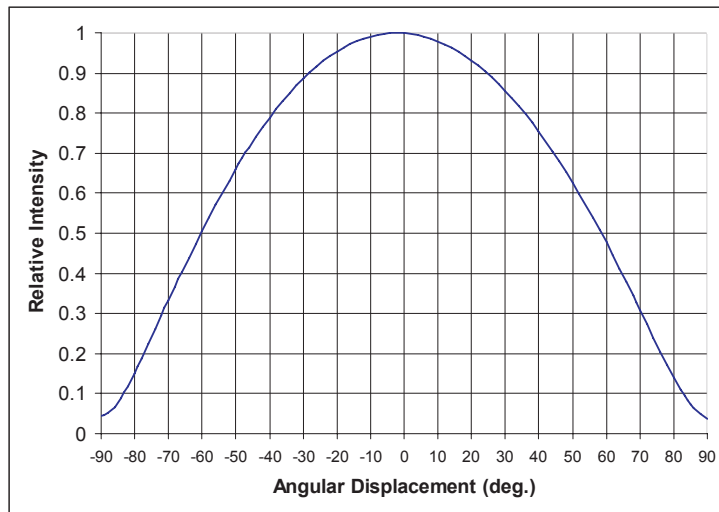

Figure 10. Typical Representative Spatial Radiation Pattern (Far Field) for LXCL-PWF1 and LXCL-PWF3.

## Recommended Solder Pad Layout for LXCL-PWF1 and LXCL-PWF3

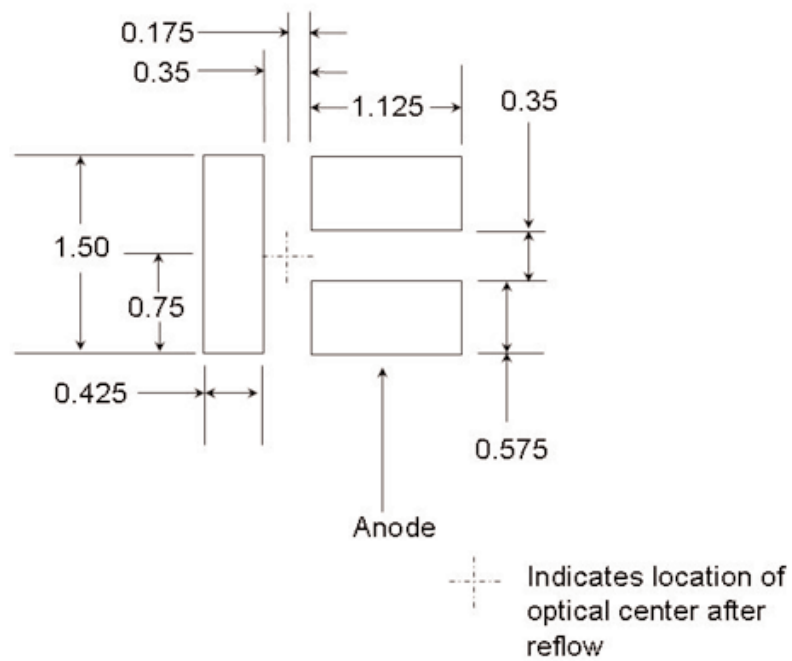

Figure 11. Split pad layout aids in aligning device during reflow.



# Reel Packaging (LXCL-PWF1 and LXCL-PWF3)

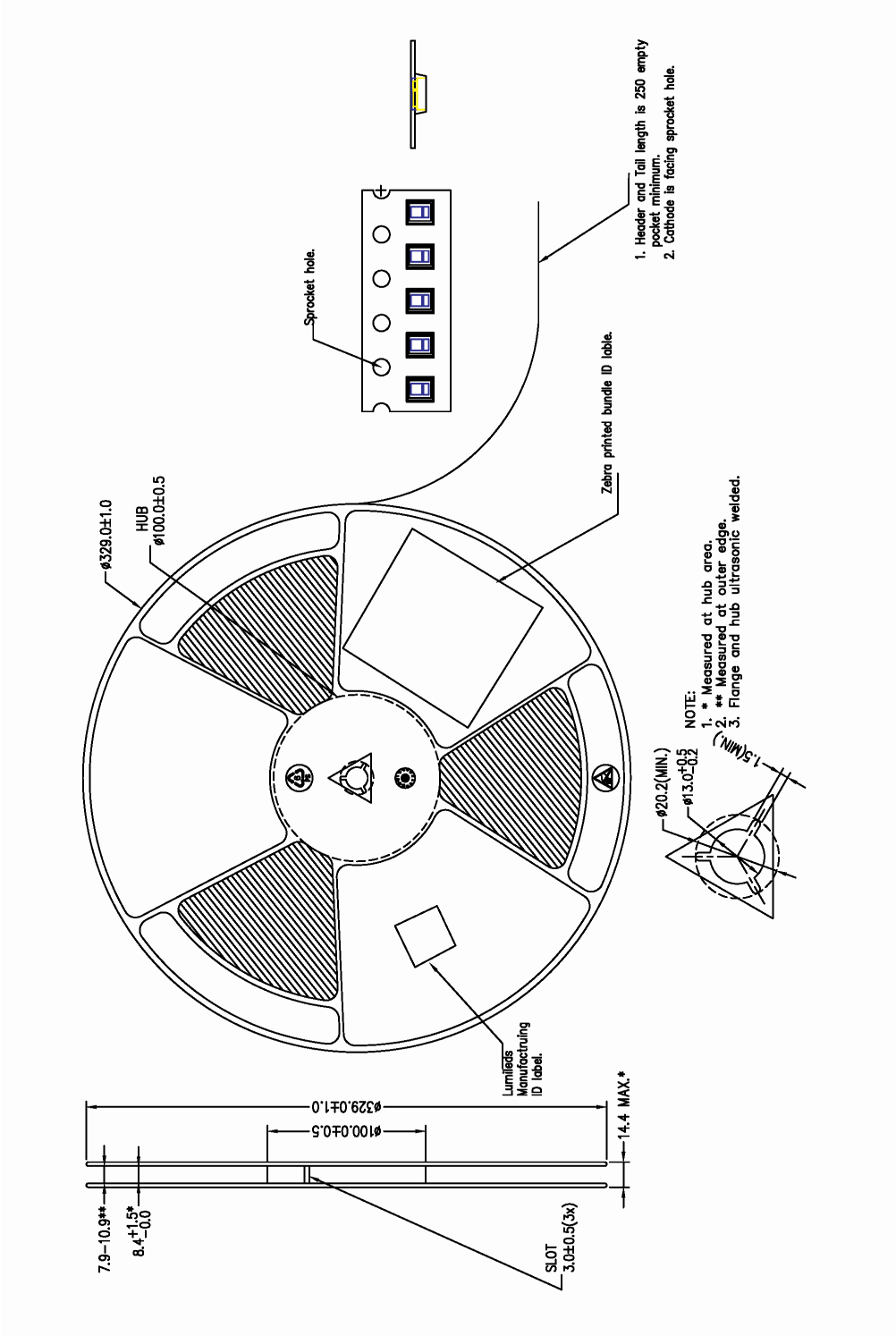

Figure 12. Reel dimensions and orientation.

Notes for Figure 12:

1. Drawings not to scale.
2. All dimensions are in millimeters.
3. All dimensions without tolerances are for reference only.

## Emitter Packaging (LXCL-PWF1 and LXCL-PWF3)

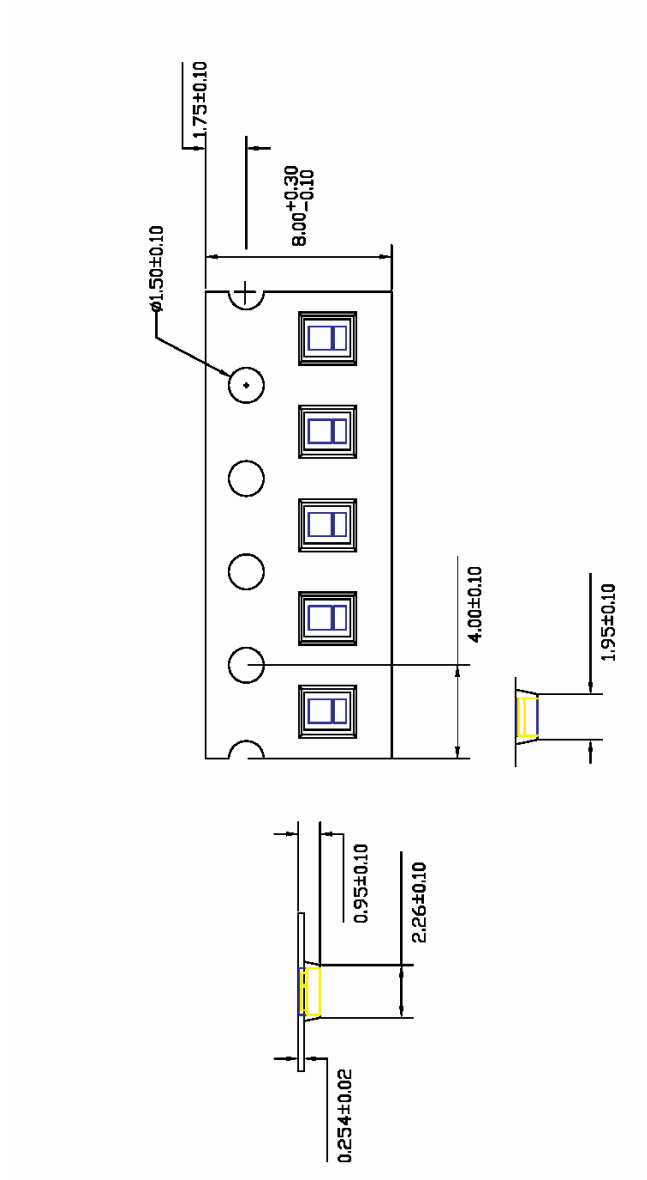

Figure 13. Tape Dimensions.

Notes for Figure 13:

1. Drawings not to scale.
2. All dimensions are in millimeters.
3. All dimensions without tolerances are for reference only.



### Company Information

LUXEON®, SuperFlux and SnapLED are developed, manufactured and marketed by Philips Lumileds Lighting Company. Philips Lumileds is a world-class supplier of Light Emitting Diodes (LEDs) producing billions of LEDs annually. Philips Lumileds is a fully integrated supplier, producing core LED material in all three base colors (Red, Green, Blue) and White. Philips Lumileds has R&D centers in San Jose, California and in The Netherlands and production capabilities in San Jose and Penang, Malaysia. Founded in 1999, Philips Lumileds is the high-flux LED technology leader and is dedicated to bridging the gap between solid-state LED technology and the lighting world. Philips Lumileds technology, LEDs and systems are enabling new applications and markets in the lighting world.

Philips Lumileds may make process or materials changes affecting the performance or other characteristics of our products. These products supplied after such changes will continue to meet published specifications, but may not be identical to products supplied as samples or under prior orders.



[WWW.LUXEON.COM](http://WWW.LUXEON.COM)  
[WWW.LUMILEDSFUTURE.COM](http://WWW.LUMILEDSFUTURE.COM)

FOR TECHNICAL ASSISTANCE OR THE LOCATION OF YOUR NEAREST SALES OFFICE CONTACT ANY OF THE FOLLOWING:

**NORTH AMERICA:**  
+1 888 589 3662 OR  
[ASKLUXEON@FUTUREELECTRONICS.COM](mailto:ASKLUXEON@FUTUREELECTRONICS.COM)

**EUROPE:**  
OO 800 443 88 873 OR  
[LUXEON.EUROPE@FUTUREELECTRONICS.COM](mailto:LUXEON.EUROPE@FUTUREELECTRONICS.COM)

**ASIA:**  
800 5864 5337 OR  
[LUMILEDS.ASIA@FUTUREELECTRONICS.COM](mailto:LUMILEDS.ASIA@FUTUREELECTRONICS.COM)