

Silicon NPN Power Transistors

2SC4511

DESCRIPTION

- With TO-220F package
- Complement to type 2SA1725

APPLICATIONS

- Audio and general purpose

PINNING

PIN	DESCRIPTION
1	Base
2	Collector
3	Emitter

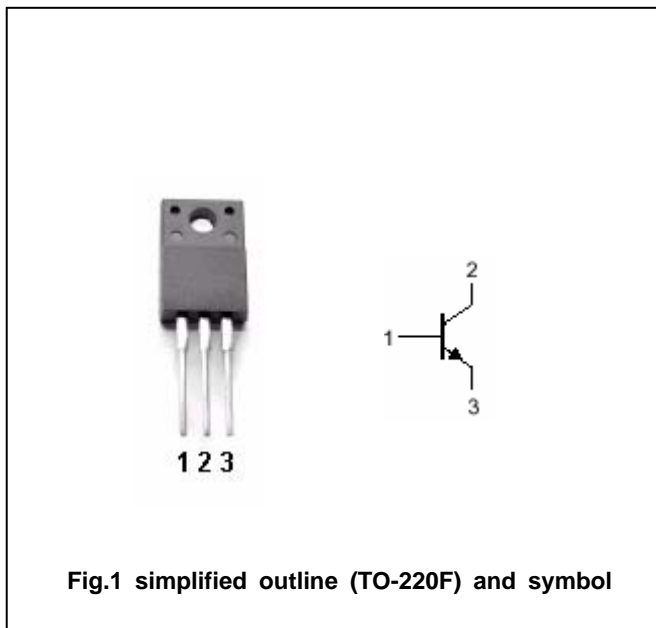

Fig.1 simplified outline (TO-220F) and symbol

Absolute maximum ratings (Ta=25)

SYMBOL	PARAMETER	CONDITIONS	VALUE	UNIT
V_{CBO}	Collector-base voltage	Open emitter	120	V
V_{CEO}	Collector-emitter voltage	Open base	80	V
V_{EBO}	Emitter-base voltage	Open collector	6	V
I_C	Collector current		6	A
I_B	Base current		3	A
P_C	Collector dissipation	$T_C=25$	30	W
T_j	Junction temperature		150	
T_{stg}	Storage temperature		-55~150	

Silicon NPN Power Transistors

2SC4511

CHARACTERISTICS

T_j=25 unless otherwise specified

SYMBOL	PARAMETER	CONDITIONS	MIN	TYP.	MAX	UNIT
V _{(BR)CEO}	Collector-emitter breakdown voltage	I _C =25mA ; I _B =0	80			V
V _{CEsat}	Collector-emitter saturation voltage	I _C =2A; I _B =0.2A			0.5	V
I _{CBO}	Collector cut-off current	V _{CB} =120V; I _E =0			10	μA
I _{EBO}	Emitter cut-off current	V _{EB} =6V; I _C =0			10	μA
h _{FE}	DC current gain	I _C =2A ; V _{CE} =4V	50		180	
C _{OB}	Output capacitance	I _E =0; V _{CB} =10V;f=1MHz		110		pF
f _T	Transition frequency	I _E =-0.5A ; V _{CE} =12V		20		MHz

Switching times

t _{on}	Turn-on time	I _C =3.0A I _{B1} =-I _{B2} =0.3A V _{CC} =30V ,R _L =10		0.16		μs
t _s	Storage time			2.60		μs
t _f	Fall time			0.34		μs

◆ h_{FE} Classifications

O	P	Y
50-100	70-140	90-180

Silicon NPN Power Transistors

2SC4511

PACKAGE OUTLINE

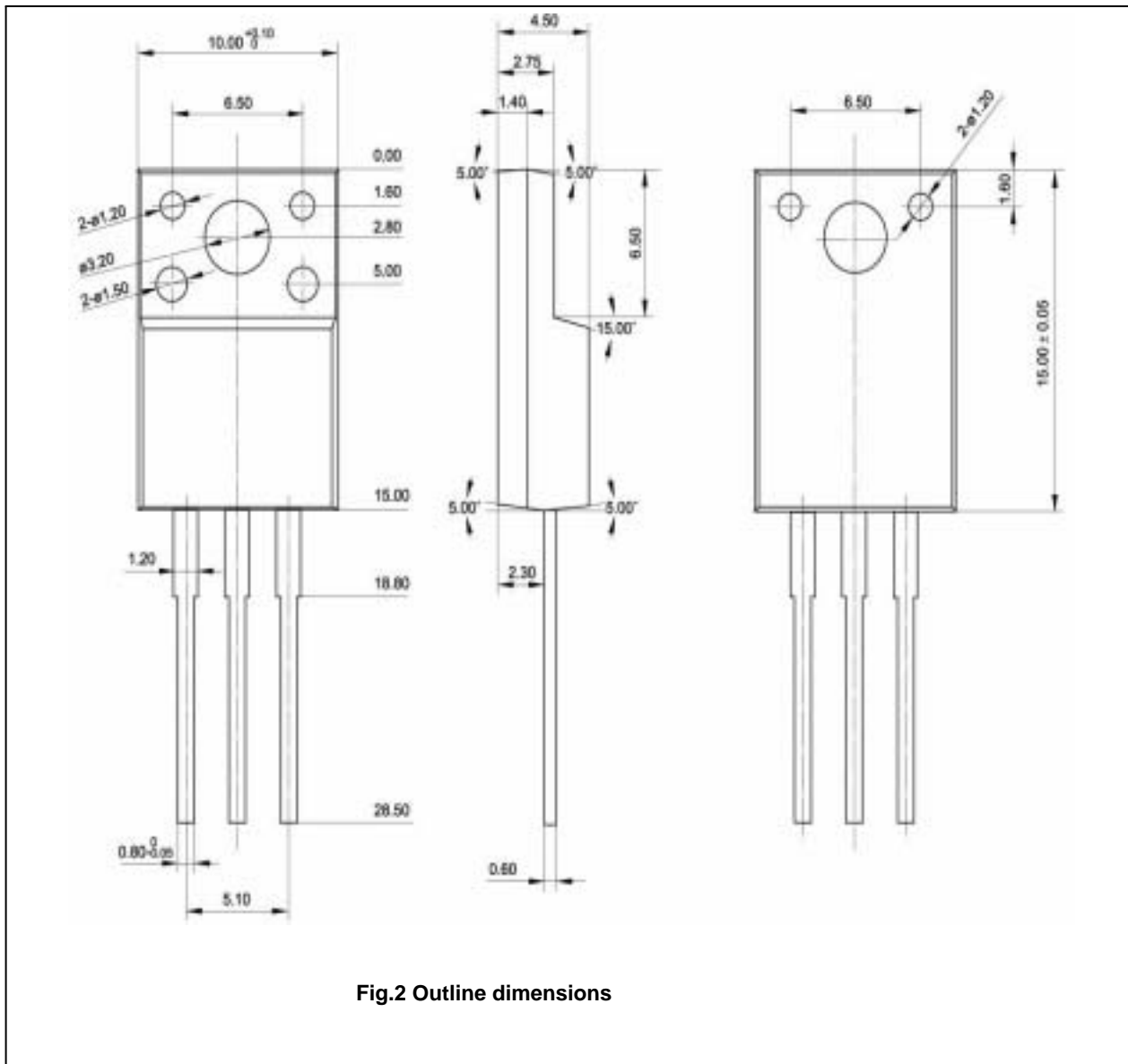

Fig.2 Outline dimensions

Silicon NPN Power Transistors

2SC4511

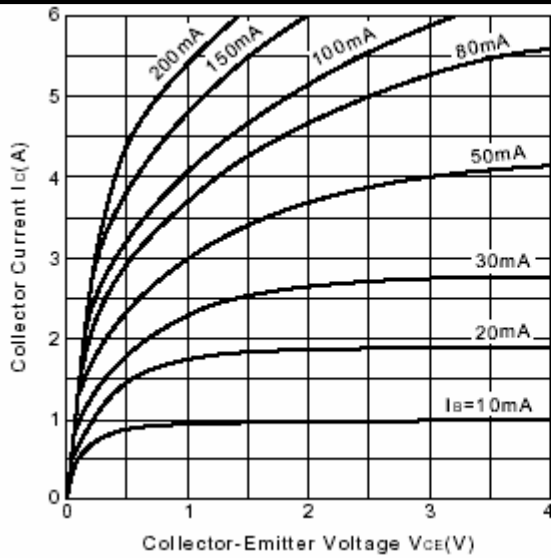

Fig.3 Static Characteristic

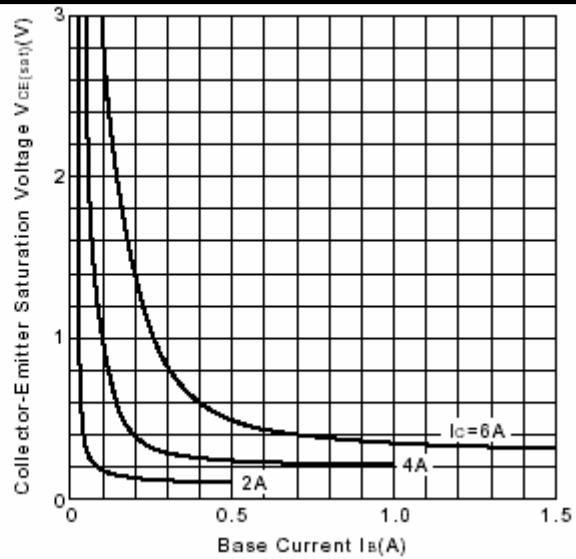

Fig.4 $V_{CE(sat)}$ - I_B Characteristics

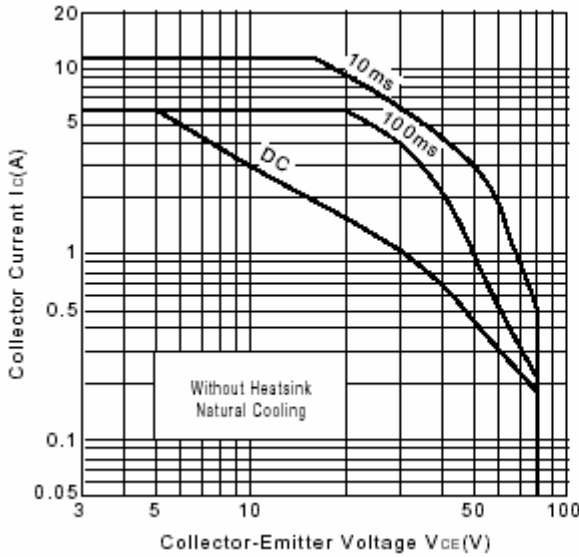

Fig.5 Safe Operating Area

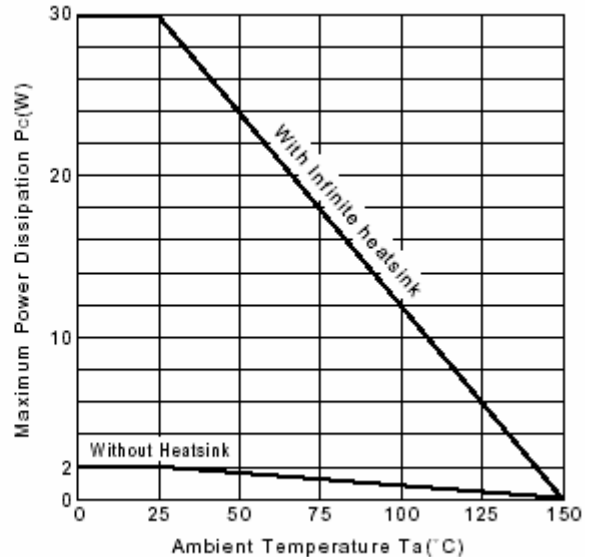

Fig.6 P_c - T_a Derating

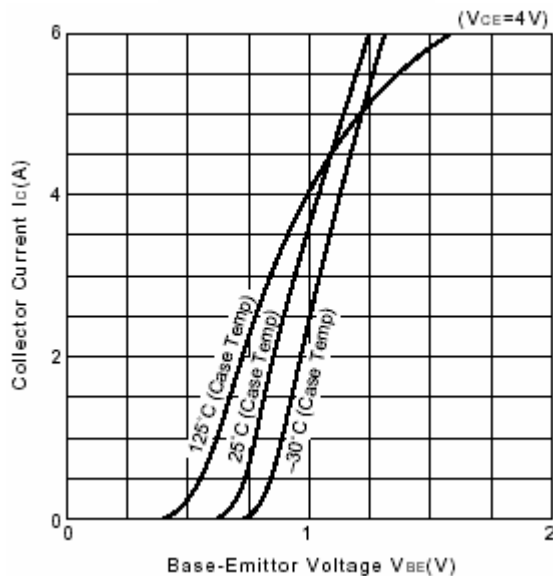

Fig.7 I_c - V_{BE}

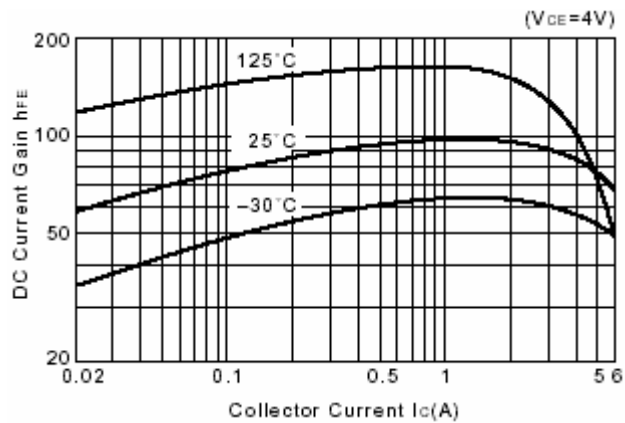

Fig.8 DC current Gain