



# SANYO Semiconductors DATA SHEET

## STK673-010-E

Thick-Film Hybrid IC  
Bipolar Fixed-Current Chopper (external excitation  
PWM) Built-in Microstepping Control  
3-Phase Stepping Motor Driver  
(sine wave drive) Output Current 2.4A

### Overview

The STK673-010-E is a 3-phase stepping motor driver hybrid IC with built-in microstep controller having a bipolar constant current PWM system, in which a power MOSFET is employed at an output stage. It includes a 3-phase distributed controller for a 3-phase stepping motor to realize a simple configuration of the motor driver circuit.

The number of motor revolution can be controlled by the frequency of external clock input. 2, 2-3, W2-3 and 2W2-3-phase excitation modes are available. The basic step angle of the stepping motor can be separated as much as one-eighth 2-3-phase to 2W2-3-phase excitation mode control quasi-sine wave current, thereby realizing low vibration and low noise.

### Applications

- As a 3-phase stepping motor driver for transmission and reception in a facsimile.
- As a 3-phase stepping motor driver for feeding paper feed or for an optical system in a copying machine.
- Industrial machines or products employing 3-phase stepping motor driving.

### Features

- Number of motor revolution can be controlled by the frequency of external clock input.
- 4 types of modes, i.e., 2, 2-3, W2-3 and 2W2-3-phase excitations, are available which can be selected based on rising of clock signals, by switching Highs and Lows of Mode A and Mode B terminals.
- Setting a Mode C terminal Low allows an excitation mode that is based on rising and falling of a clock signal. By setting the Mode C terminal Low, phases that are set only by Mode A and Mode B can be changed to other phases as follows without changing the number of motor revolution: 2-phase may be switched to 2-3-phase; 2-3-phase may be switched to W2-3-phase; and W2-3-phase may be switched to 2W2-3-phase.
- Phase is maintained even when the excitation mode is changed.

Continued on next page.

■ Any and all SANYO Semiconductor Co.,Ltd. products described or contained herein are, with regard to "standard application", intended for the use as general electronics equipment (home appliances, AV equipment, communication device, office equipment, industrial equipment etc.). The products mentioned herein shall not be intended for use for any "special application" (medical equipment whose purpose is to sustain life, aerospace instrument, nuclear control device, burning appliances, transportation machine, traffic signal system, safety equipment etc.) that shall require extremely high level of reliability and can directly threaten human lives in case of failure or malfunction of the product or may cause harm to human bodies, nor shall they grant any guarantee thereof. If you should intend to use our products for applications outside the standard applications of our customer who is considering such use and/or outside the scope of our intended standard applications, please consult with us prior to the intended use. If there is no consultation or inquiry before the intended use, our customer shall be solely responsible for the use.

■ Specifications of any and all SANYO Semiconductor Co.,Ltd. products described or contained herein stipulate the performance, characteristics, and functions of the described products in the independent state, and are not guarantees of the performance, characteristics, and functions of the described products as mounted in the customer's products or equipment. To verify symptoms and states that cannot be evaluated in an independent device, the customer should always evaluate and test devices mounted in the customer's products or equipment.

**SANYO Semiconductor Co., Ltd.**

TOKYO OFFICE Tokyo Bldg., 1-10, 1 Chome, Ueno, Taito-ku, TOKYO, 110-8534 JAPAN

# STK673-010-E

Continued from preceding page.

- An MOI output terminal which outputs 1 pulse per 1 cycle of phase current.
- A CW/CCW terminal which switches the rotational direction.
- A Hold terminal which temporarily holds the motor in a state where the phase current is conducted.
- An Enable terminal which can forcibly turns OFF a MOSFET of a 6 output driving element in normal operation.
- Schmitt inputs with built-in pull-up resistor (20kΩ typ)
- Motor current can be set by changing the voltage of the Vref terminal (0.63V per 1A, dealing as much as 0 to 1/2V<sub>CC2</sub> (4A)).
- The clock input for controlling the number of motor revolution lies in a range of 0 to 50kHz.
- Supply voltage: V<sub>CC1</sub> = 16 to 30V, V<sub>CC2</sub> = 5.0V ±5%
- A built-in current detection resistor (0.227Ω)
- A motor current during revolution can deal with as high as 2.4A at T<sub>c</sub> = 105°C and as high as 4A at T<sub>c</sub> = 50°C or lower.

## Specifications

### Maximum Ratings at T<sub>c</sub> = 25°C

Parameter	Symbol	Conditions	Ratings	Unit
Maximum supply voltage 1	V <sub>CC1</sub> max	V <sub>CC2</sub> = 0V	36	V
Maximum supply voltage 2	V <sub>CC2</sub> max	No signal	-0.3 to +7.0	V
Input voltage	V <sub>IN</sub> max	Logic input pins	-0.3 to +7.0	V
Phase output current	I <sub>O</sub> max	V <sub>CC2</sub> = 5 V, CLOCK ≥ 100Hz	4.0	A
Operating substrate temperature	T <sub>c</sub> max		105	°C
Junction temperature	T <sub>J</sub> max		150	°C
Storage temperature	T <sub>stg</sub>		-40 to +125	°C

### Allowable Operating Ranges at T<sub>a</sub> = 25°C

Parameter	Symbol	Conditions	Ratings	Unit
Operating supply voltage 1	V <sub>CC1</sub>	With signal	16 to 30	V
Operating supply voltage 2	V <sub>CC2</sub>	With signal	5.0V ± 5%	V
Input voltage	V <sub>IH</sub>		0 to V <sub>CC2</sub>	V
Phase output current 1	I <sub>O1</sub>	Without heat sink	1.7	A
Phase output current 2	I <sub>O2</sub>	T <sub>c</sub> = 105°C	2.4	A
Clock frequency	f <sub>CL</sub>	Pin 11 input frequency	0 to 50	kHz

### Electrical Characteristics at T<sub>c</sub> = 25°C, V<sub>CC1</sub> = 24V, V<sub>CC2</sub> = 5V

Parameters	Symbol	Conditions	Rating			unit
			min	typ	max	
V <sub>CC2</sub> supply current	I <sub>CCO</sub>	Enable=Low		6.1	12	mA
Effective output current	I <sub>oave</sub>	Each phase R/L=2Ω /6mH 2W2-3-phase excitation V <sub>ref</sub> = 0.61V	0.62	0.69	0.76	Arms
FET diode forward voltage	V <sub>df</sub>	I <sub>f</sub> = 1A (R <sub>L</sub> =23Ω)		1.0	1.6	V
Output saturation voltage	V <sub>sat</sub>	R <sub>L</sub> = 23Ω		0.45	0.56	V
Output leakage current	I <sub>OL</sub>	R <sub>L</sub> = 23Ω			0.1	mA
Input high voltage	V <sub>IH</sub>	9 terminals, Pins 11 to 18, 22	4.0			V
Input low voltage	V <sub>IL</sub>	9 terminals, Pins 11 to 18, 22			1.0	V
Input current	I <sub>IL</sub>	Pins 11 to 18 pin = GND level pull-up resistance 20kΩ (typ)	115	250	550	μA
V <sub>ref</sub> input voltage	V <sub>rH</sub>	Pin 10			V <sub>CC2</sub> /2	V
V <sub>ref</sub> input current	I <sub>r</sub>	Pin 10, pin 10 = 2.5V Internal resistance 40kΩ (typ)	440	625	810	μA
MOI output high voltage	V <sub>OH</sub>	Pin 20, pin 20 to 19 = 820Ω	2.5			V
MOI output low voltage	V <sub>OL</sub>	Pin 20, pin 21 to 20 = 1.6kΩ			0.4	V
PWM frequency	f <sub>c</sub>			63		kHz

Note: Constant voltage supply is used.

Package Dimensions

unit:mm (typ)

4130

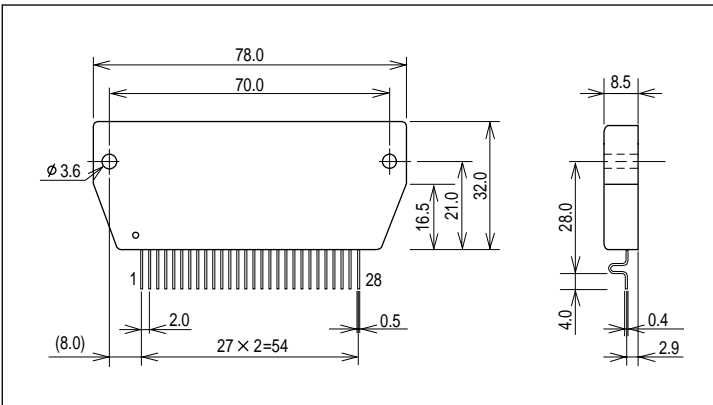

Electrical Characteristics 2 at Tc = 25°C, VCC1 = 24V, VCC2 = 5V

Current division ratio at phase current of 1/4 electrorotation, in each excitation mode (unit = %, typ.) Number of current division is put in parentheses.

Current division	2 phase (1)	2-3 phase (3)	W2-3 phase (6)	2W2-3 phase (12)	
1/96	0	0	0	0	
2/96				13	
3/96			26	26	
4/96					38
5/96					
6/96	50	50			
7/96			61		
8/96	71	71			
9/96			79		
10/96	87	87			
11/96			87	87	
12/96	92				
13/96		96	96		
14/96	96			96	
15/96		98			
16/96	100		100		
17/96		100		100	
18/96	100		100		
19/96		100		100	
20/96	100		100		
21/96		100		100	
22/96	100		100		
23/96		100		100	
24/96	100		100		
		100		100	100

Note: Constant voltage supply is used as power supply.

Electrical Characteristic 2 represents design values. Measurement for controlling the standard value is not conducted.

Equivalent Block Diagram

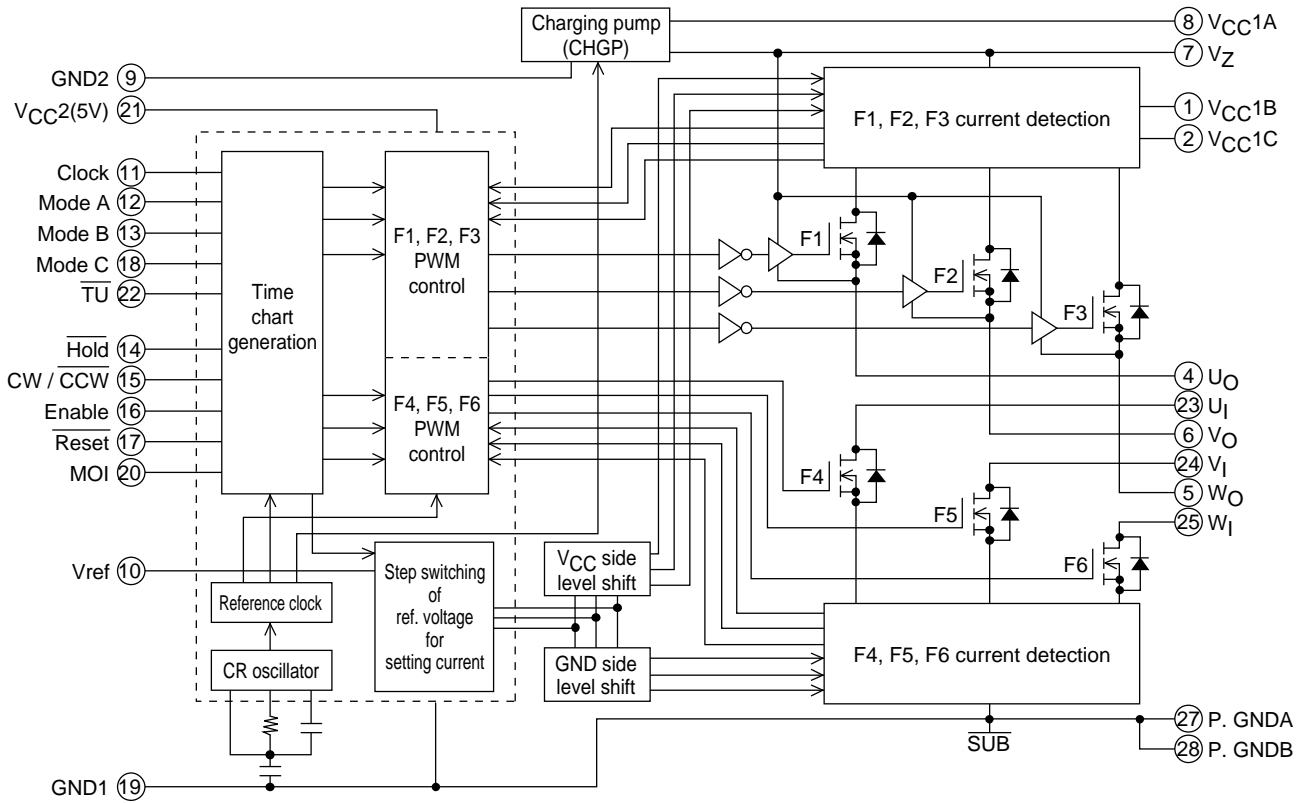

ITF00807

Sample Application Circuit

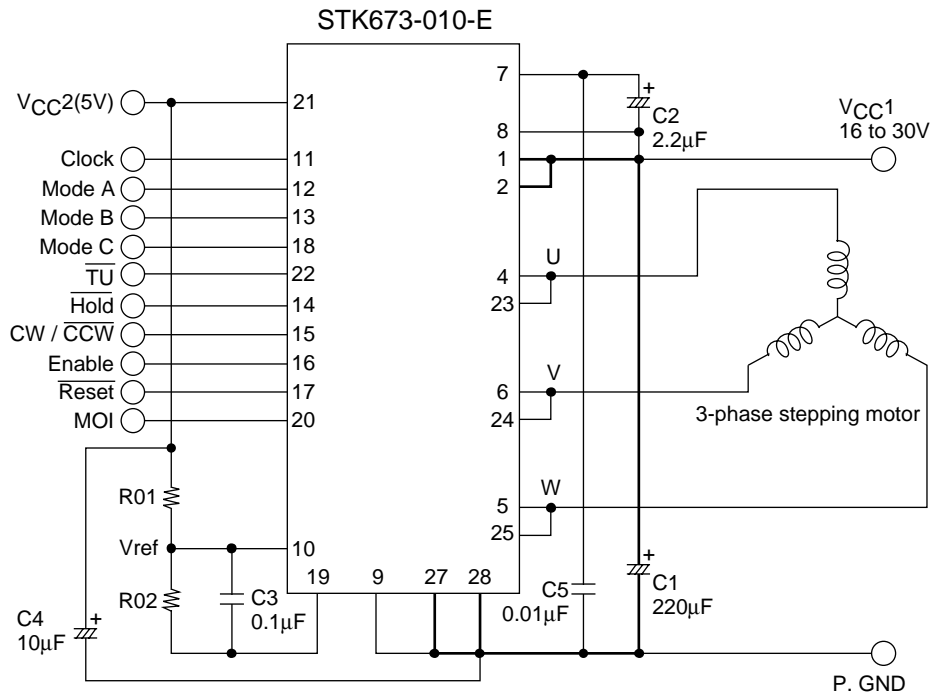

ITF00808

# STK673-010-E

## Set Equation of Output Current $I_O$ Peak Value

$$I_O \text{ peak} = V_{\text{ref}} \div K \quad K = 0.63 \text{ (V/A)}$$

where

$$V_{\text{ref}} \leq 0.5 \times V_{\text{CC2}}$$

$$V_{\text{ref}} = V_{\text{CC2}} \times R_{\text{ox}} \div (R_{\text{O1}} + R_{\text{ox}})$$

$$R_{\text{ox}} = (R_{\text{O2}} \times 4.0\text{k}\Omega) \div (R_{\text{O2}} + 4.0\text{k}\Omega)$$

- R02 is preferably set to be 100Ω in order to minimize the effect of the internal impedance (4.0kΩ ±30%) of STK673-010-E
- For noise reduction in 5V system, put the GND side of bypass capacitor (220μF) of V<sub>CC1</sub> (shown in a thick line in the above Sample Application Circuit) in the vicinity of pins 27 and 28 of the hybrid IC.
- Set the capacitance value of the bypass capacitor C1 such that a ripple current of a capacitance, which varies in accordance with the increase of motor current, lies in an allowable range.
- K in the above-mentioned set equation varies within ±5 to ±10% depending on the inductance L and resistance value R of the used motor. Check the peak value setting of  $I_O$  upon actual setting.

## Input/Output Terminals Functions of 5V System

Terminal name	No.	Function	Conditions upon Functioning 0 = Low, 1 = High
Clock	11	Basic clock for switching phase current of motor Input frequency range: DC to 50kHz Minimum pulse width: 10μs High level duty: 40 to 60%	Rising edge in Mode C = 1 Rising and falling edge in Mode C = 0
Mode A	12	Sets excitation mode	See table listed below
Mode B	13	Sets excitation mode	See table listed below
Mode C	18	Sets excitation mode	See table listed below
$\overline{\text{TU}}$	22	Sets excitation mode Switches 2-3 phase excitation of step current to rectangular current More effective in increasing torque than in lowering vibration of motor	See table listed below
Hold	14	Temporarily holds the motor in a state	0
CW/ $\overline{\text{CCW}}$	15	Switches the rotational direction of the motor	1 = CW, 0 = $\overline{\text{CCW}}$
Enable	16	Turns OFF all of the driving MOSFET	0
$\overline{\text{Reset}}$	17	System reset Make sure to input a reset signal of 10μs or more	0
MOI	20	Monitors the number of revolution of the motor	Outputs 1 pulse of a high level signal per one cycle of phase current
Vref	10	Sets the peak value of the motor current set at 0.63V per 1A	Maximum value $0.5 \times V_{\text{CC2}}$ (4A max)

## Excitation Mode Table

Input condition				Excitation No.	Excitation Mode	Number of current steps	Number of clock pulse per one cycle of phase current
Mode A	Mode B	Mode C	TU				
0	0	1	1	(1)	2-phase	1	6
0	1	1	1	(2)	2-3-phase	3	12
0	1	1	0	(3)	2-3-phase TU	1	12
1	0	1	1	(4)	W2-3-phase	6	24
1	1	1	1	(5)	2W2-3-phase	12	48
0	0	0	1	(6)	2-3-phase	3	6
0	0	0	0	(7)	2-3-phase TU	1	6
0	1	0	1	(8)	W2-3-phase	6	12
1	0	0	1	(9)	2W2-3-phase	12	24

As shown in the table, TU terminal is only effective for Excitation Nos. (3) and (7).

Although the present hybrid IC is not damaged even when TU = 0 is mistakenly input in Excitation, other than Excitation Nos. (3) and (7), motor vibration or motor current may increase.

\* Timing charts for 3-phase stepping motor driver is illustrated on pages 9 to 13 for exemplary operations of Enable, Hold, CW/ $\overline{\text{CCW}}$  for Excitation Nos. (1), (2), (3), (4), (5) and (9), and Excitation No. (4).

**Notes On Use**

(1) Input terminal use of 5V system

[ $\overline{\text{RESET}}$  and Clock (timing of input signal upon rising of power supply)]

The driver is configured to include a 5V system logic section and a 24V MOSFETs section. The MOSFETs on both VCC1 side and GND side are N-channels. Thus, the MOSFETs on the VCC1 side is provided with a charging pump circuit for generating a voltage higher than that of VCC1. When a Low signal is input to a RESET terminal for operating the RESET, the charging pump is stopped. After the release of the RESET (High input), it requires a period of 1.7ms to rise the charging pump. Accordingly, even when a Clock signal is input during the rising of the charging pump circuit, the MOSFET cannot be operated. Such a timing needs to be taken into consideration for inputting a Clock signal. An example of timing is shown in Figure 1.

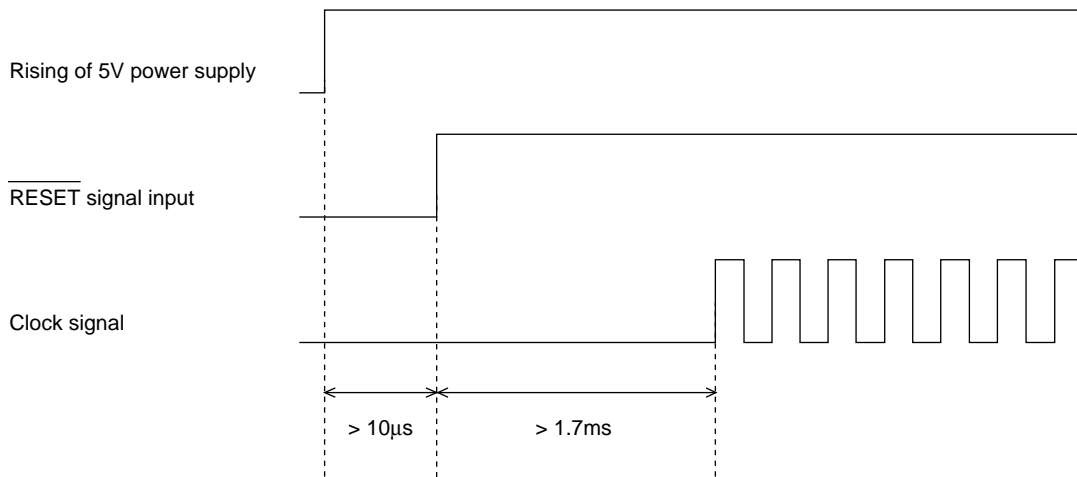

ITF00809

Figure 1. Timing chart of  $\overline{\text{RESET}}$  signal and Clock signal

When the RESET terminal switches from Low to High where a High period is 1.7ms or longer and the Clock input is conducted in a Low state, each phase current of the motor is maintained at the following values.

Phase	Current in the case where the initial Clock signal is maintained at Low level (Other than 2-3-phase TU excitation)	Current in the case where the initial Clock signal is maintained at Low level (2-3-phase TU excitation)
U phase	0	0
V phase	-87% of peak current during normal rotation	-100% of peak current during normal rotation
W phase	+87% of peak current during normal rotation	+100% of peak current during normal rotation

Refer to the timing charts for operations.

[Clock]

Clock signals should be input under the following conditions so that all 9 types of excitation modes shown in the Excitation Mode Table.

- Input frequency range    DC to 50kHz
- Minimum pulse width    10µs
- High level duty    40 to 60%

When Mode C is not used, it is an operation based on rising of the Clock and thus the above-mentioned condition of high level duty is negligible. A minimum pulse width of 10µs or more allows excitation operation by Mode A and Mode B. Since the operation is based on rising and falling of the Clock under the use of Mode C, it is most preferable to set the high level duty to 50% so as to obtain uniform step-wise current widths.

[Mode A, Mode B, Mode C and  $\overline{\text{TU}}$ ]

These 4 terminals allow selection of excitation modes. For specific operations, refer to Excitation Mode Table and Timing Charts.

[ $\overline{\text{Hold}}$ ,  $\overline{\text{CW/CCW}}$ ]

$\overline{\text{Hold}}$  temporarily holds the motor while a phase current of the motor is conducted, even when there are clock inputs of Low input.

High input releases the hold, and the motor current changes again synchronizing with the rising of Clock signals. Refer to Timing Chart for exemplary operations.

$\overline{\text{CW/CCW}}$  switches the rotational direction of the motor. Switching to High gives a rotational operation of CW, and Low gives a rotation operation of CCW. The timing of switching the rotation is synchronizes the rising of the clock signals. Refer to Timing Chart for exemplary operations.

[Enable]

High input renders a normal operation and Low input forcibly renders a gate signal of MOSFETs Low, thereby cutting a motor current. Once again High input renders a current to conduct in the motor. The timing of the current does not synchronize with the clock.

Since Low input of Enable forcibly cuts the motor current, it can be used to cut a V-phase or W-phase while Clock is maintained in a Low level state after the RESET operation.

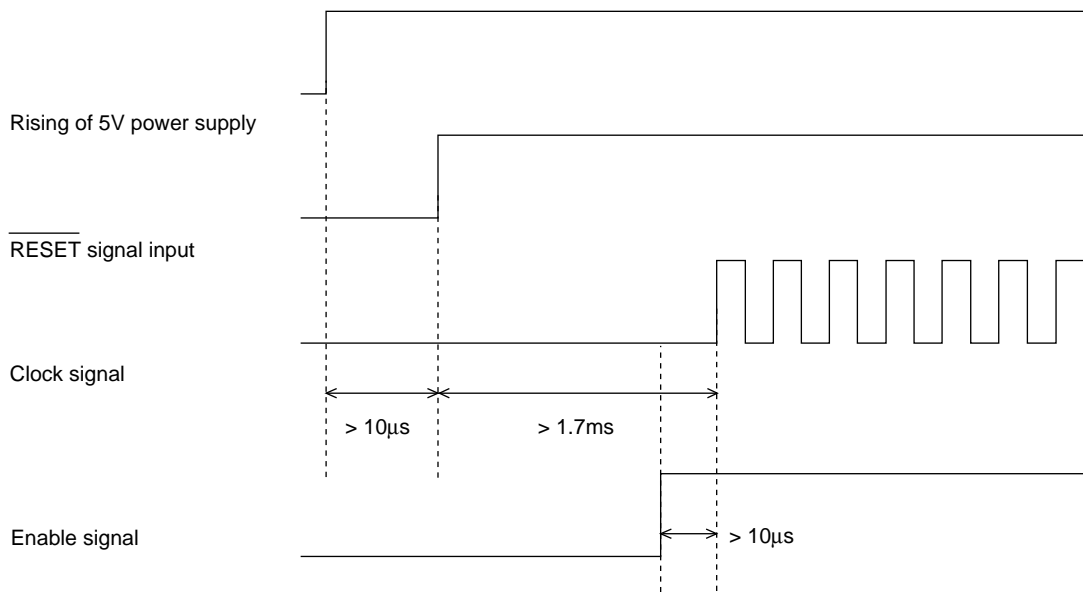

ITF00810

Figure 2. Input timings of  $\overline{\text{RESET}}$  signal, Enable signal and Clock signal

[Vref (Setting motor current peak value)]

A peak value of a motor current  $I_O$  is determined by R01, R02,  $V_{CC2}$  (5V) and the following set equation (I).

Set equation of peak value of motor current  $I_O$

$$I_O \text{ peak} = V_{\text{ref}} \div K \quad (\text{I})$$

where  $V_{\text{ref}} \leq 0.5 \times V_{CC2}$      $K = 0.63 \text{ (V/A)}$

$$V_{\text{ref}} = V_{CC2} \times R_{ox} \div (R01 + R_{ox})$$

$$R_{ox} = (R02 \times 4.0\text{k}\Omega) \div (R02 + 4.0\text{k}\Omega)$$

- R02 is preferably set to be 100 $\Omega$  in order to minimize the effect of the internal impedance (4.0k $\Omega$   $\pm$  30%) of STK673-010-E
- K in the above-mentioned set equation varies with in  $\pm 5$  to  $\pm 10\%$  depending on the inductance L and resistance value R of the used motor. Check the peak value setting of  $I_O$  upon actual setting.

\* Refer to Figure 4 for an example of Vref- $I_O$  characteristics

(2) Allowable operating ranges of motor current

Set the peak value of the motor current  $I_O$  so as to lie within a region below the curve shown in Figure 5 on page 13.

When the operation substrate temperature  $T_c$  is set to 105 $^\circ\text{C}$ ,  $I_O$  max should be 2.4A or lower and a Hold operation should be conducted where  $I_O$  max is 2.0A or lower.

For operation where  $T_c = 50^\circ\text{C}$ ,  $I_O$  max should be 4.0A or lower and a Hold operation should be conducted where  $I_O$  max is 3.3A or lower.

(3) Heat Radiation Design

Heat radiation design for reducing the operation substrate temperature of the hybrid IC is effective in enhancing the quality of the hybrid IC.

The size of a heat sink varies depending on the average power loss Pd in the hybrid IC. As shown in Figure 6 on page 14, Pd increases in accordance with the increase of the output current.

Since the starting current and the stationary current coexist in an actual motor operation, Pd cannot be obtained only from the data shown in Figure 6. Therefore, Pd is obtained assuming that the timing of the actual motor operation is a repeated operation shown in the following Figure 3.

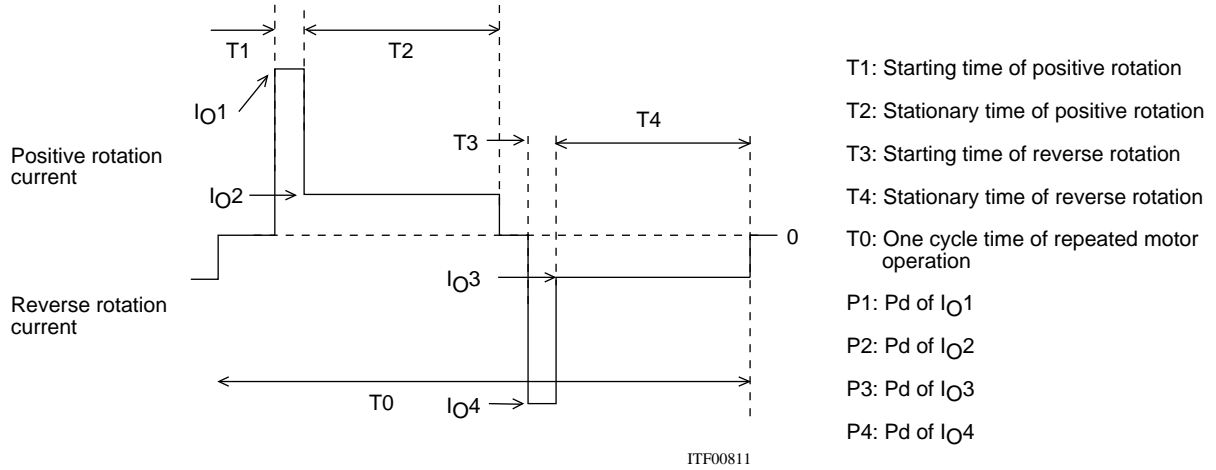

Figure 3. Timing Chart of Motor Operation

The average power loss Pd in the hybrid IC upon an operation shown in Figure 3 can be obtained by the following equation (II):

$$Pd = (T1 \times P1 + T1 \times P2 + T3 \times P3 + T4 \times P4) \div T0 \quad (II)$$

When the value obtained by the above equation (II) is equal to or less than 3.4W and the ambient temperature Ta is equal to or lower than 60°C, there is no need of providing a heat sink.

Refer to Figure 7 for data of the operation substrate temperature when no heat sink is used.

The size of the heat sink can be decided depending on θc-a obtained by the following equation (III) and from Figure 8.

$$\theta_{c-a} = (Tc \text{ max} - Ta) \div Pd \quad (III)$$

where Tc max: Maximum operation substrate temperature = 105°C

Ta: Ambient temperature of hybrid IC

Although heat radiation design can be realized by following the above equations (II) and (III), make sure to check that the substrate temperature Tc is equal to or lower than 105°C after mounting the hybrid IC into a set.



Timing Chart of 3-phase Stepping Motor Driver

2-phase excitation

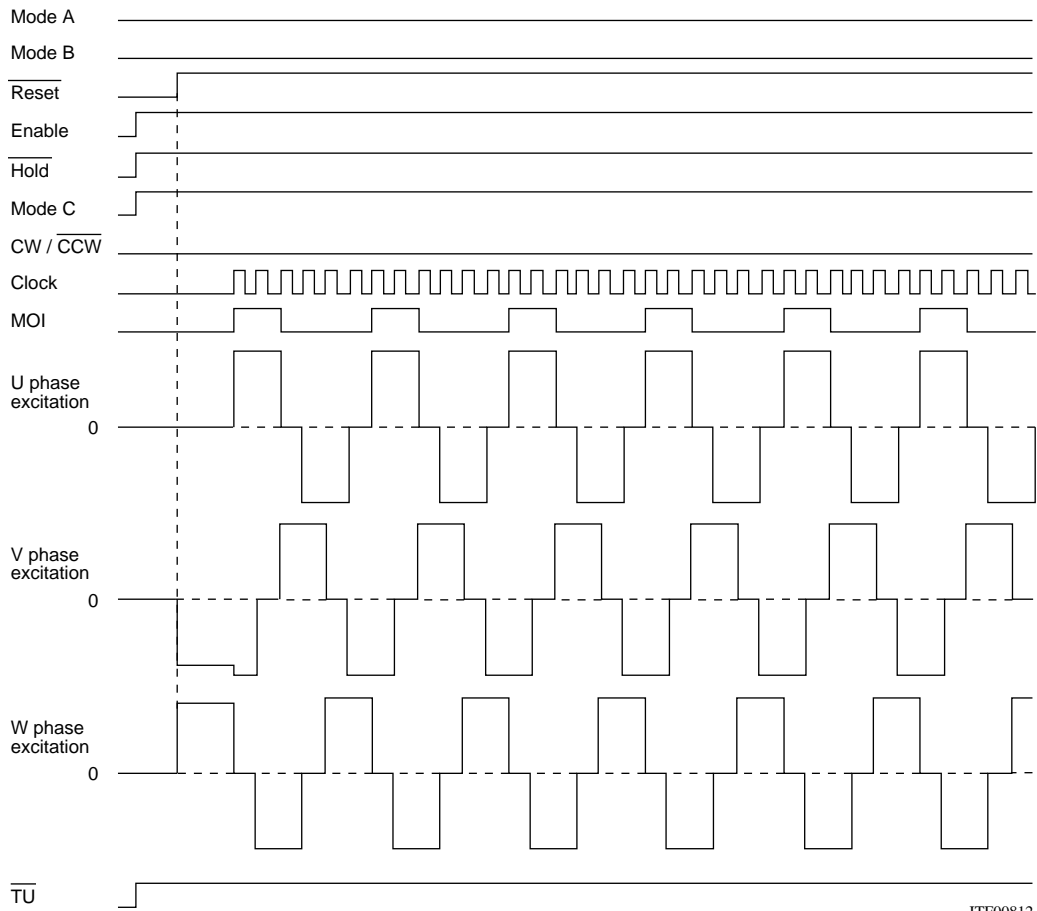

ITF00812

2-3 phase excitation

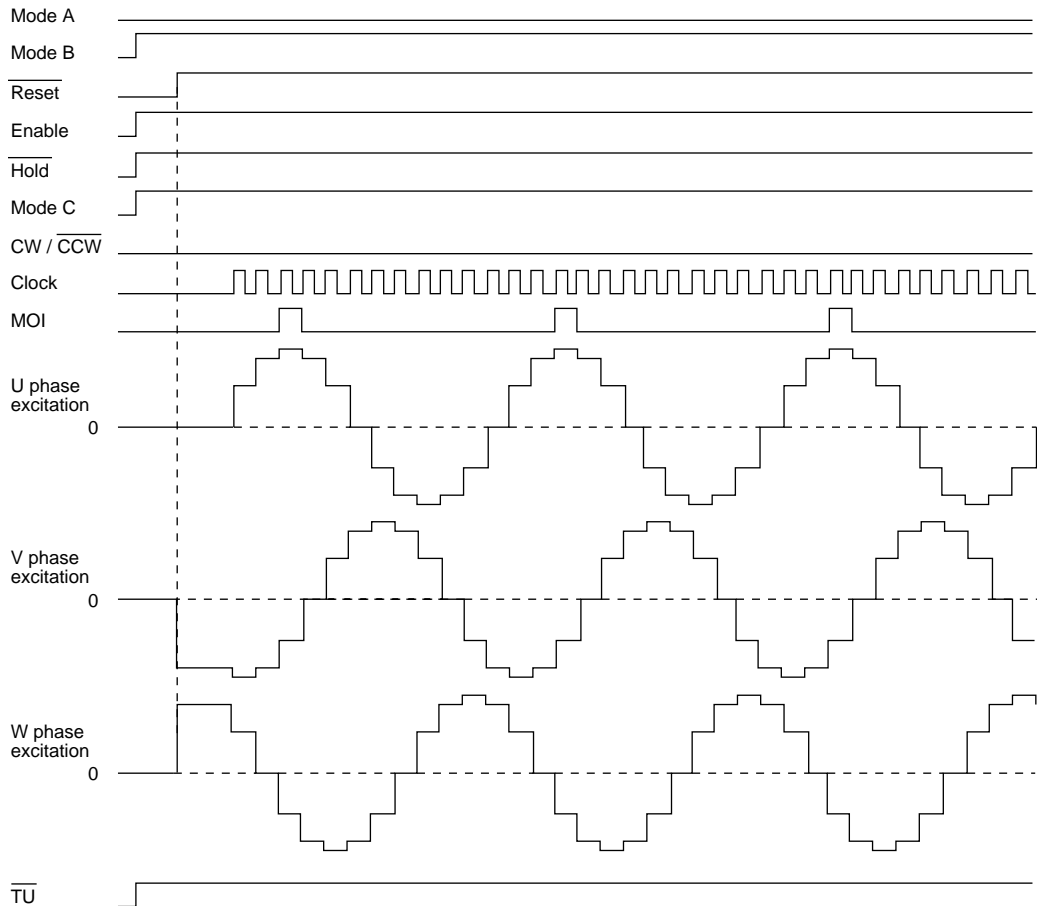

ITF00813

# STK673-010-E

## 2-3 phase excitation TU

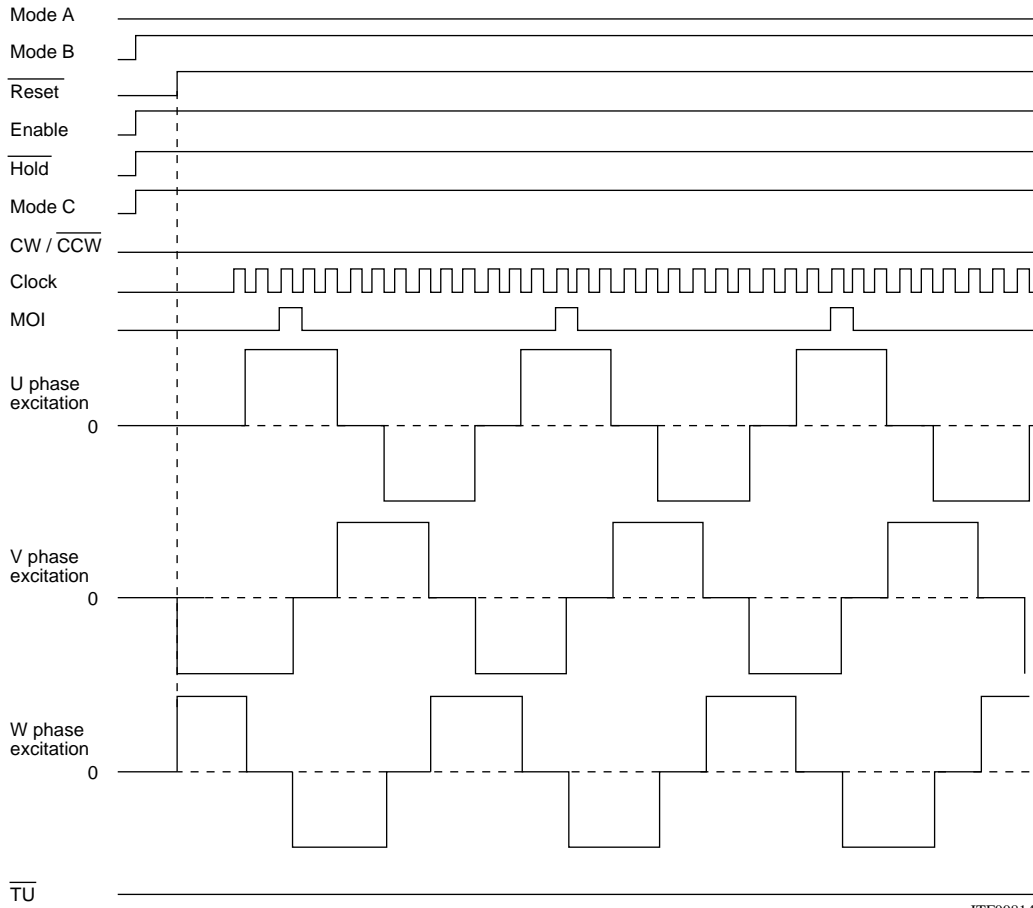

ITF00814

## W2-3 phase excitation

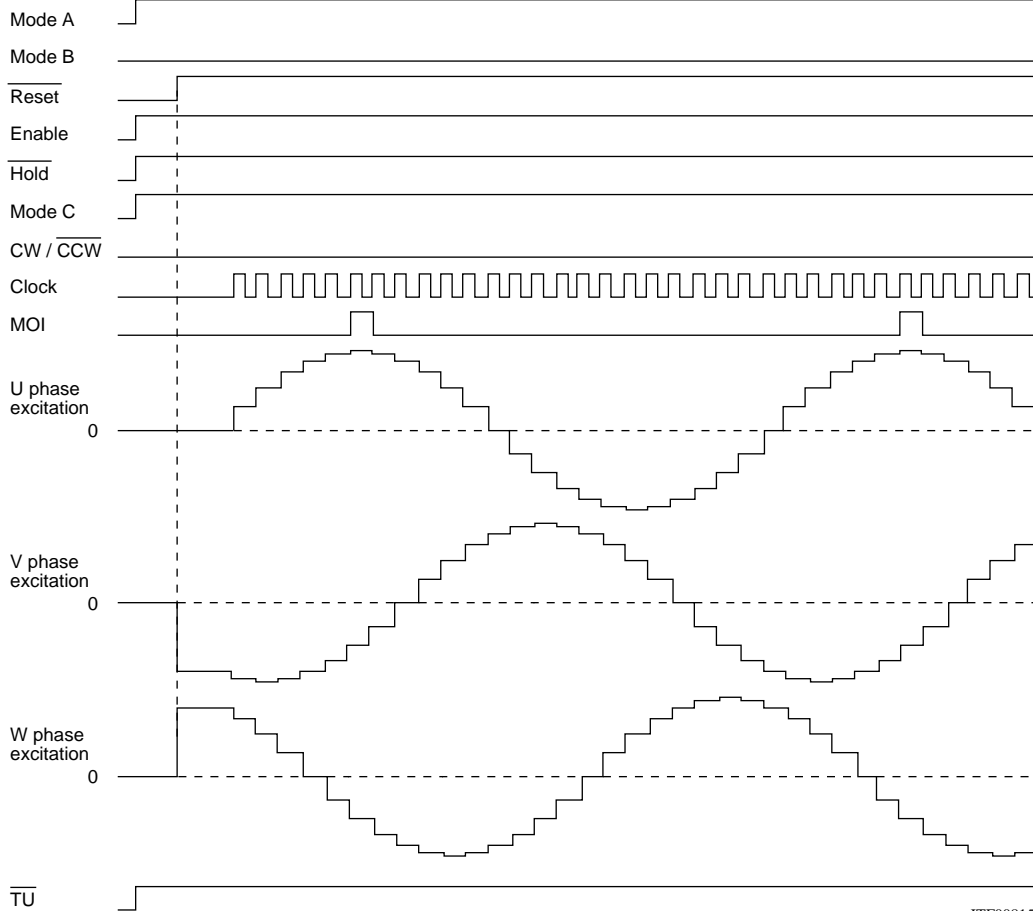

ITF00815

# STK673-010-E

## 2W2-3 phase excitation

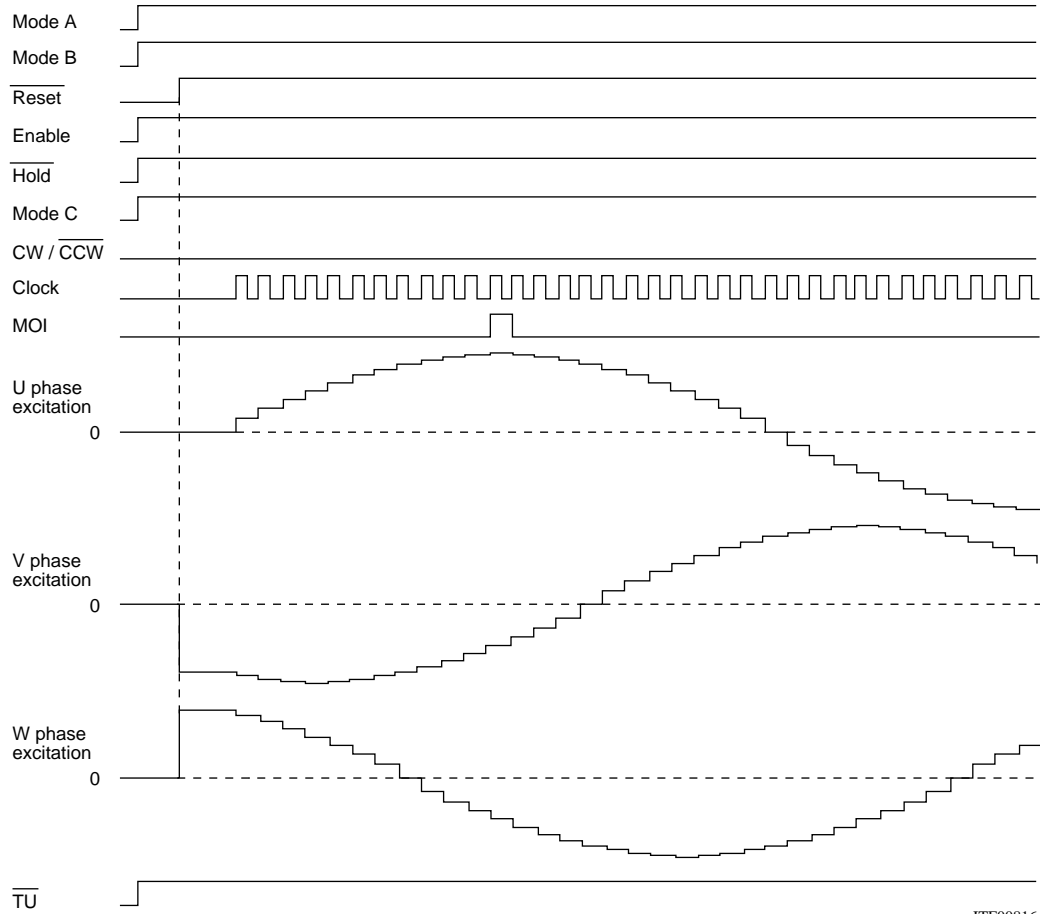

ITF00816

## W2-3 phase excitation (Enable operation)

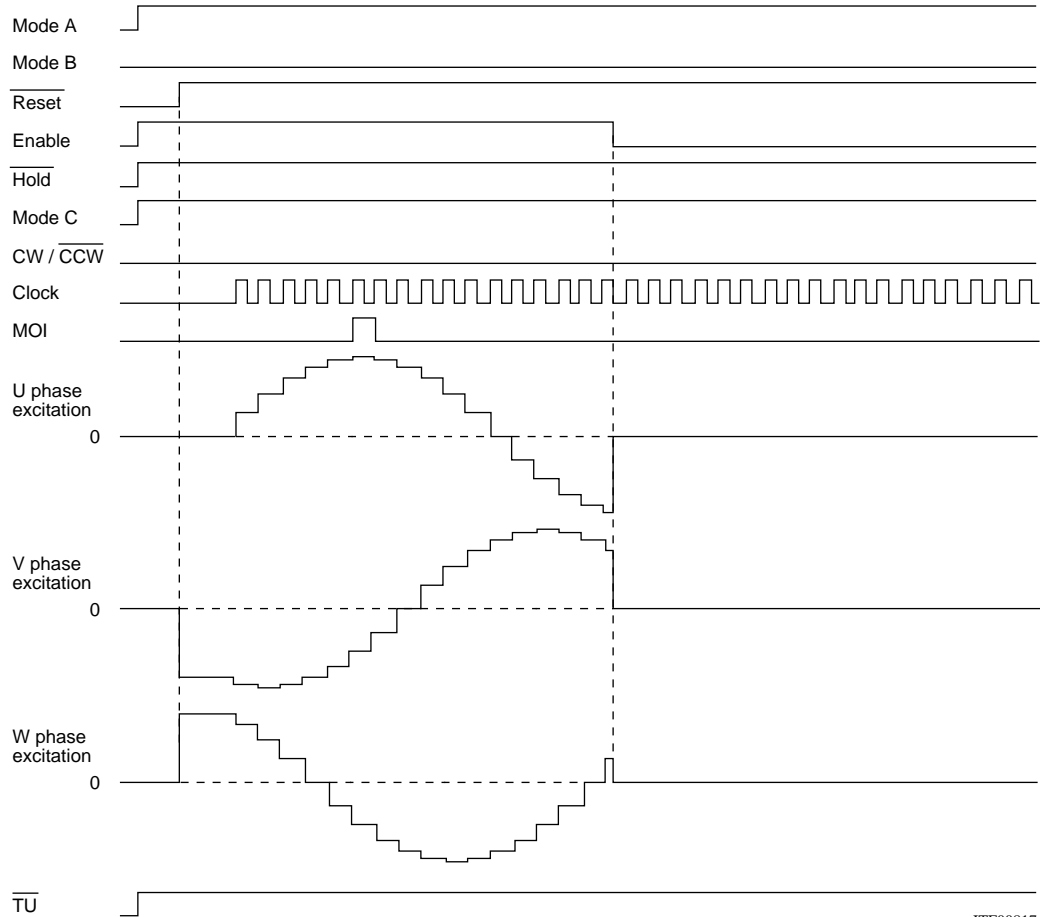

ITF00817

# STK673-010-E

## W2-3 phase excitation ( $\overline{\text{Hold}}$ operation)

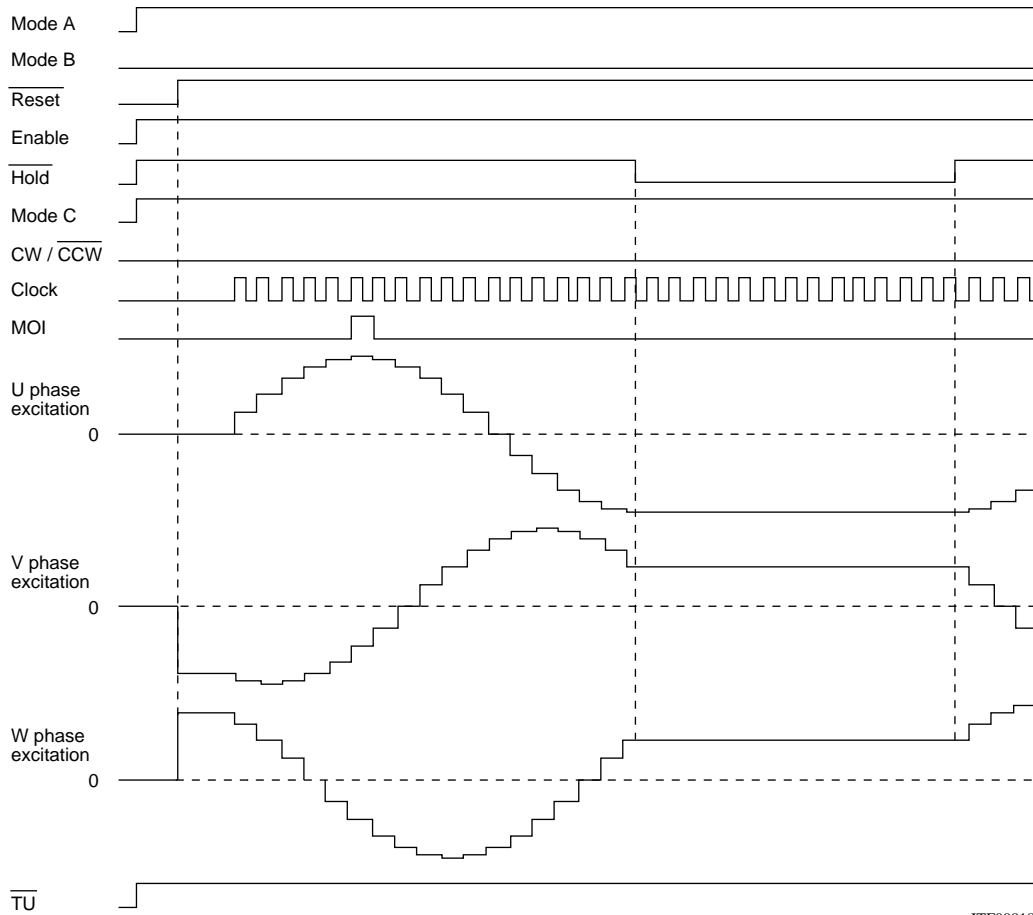

ITF00818

## W2-3 phase excitation (CW/ $\overline{\text{CCW}}$ operation)

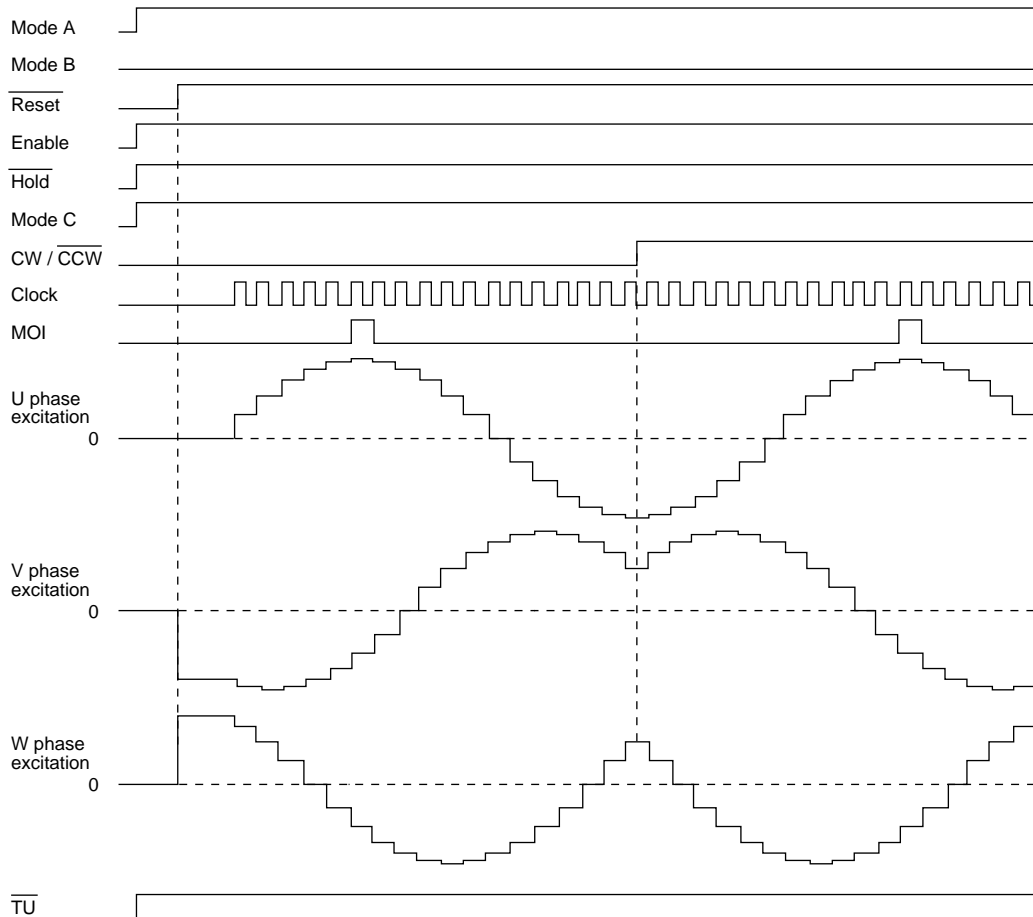

ITF00819

# STK673-010-E

W2-3 phase excitation to 2W2-3 phase excitation (Mode C operation)

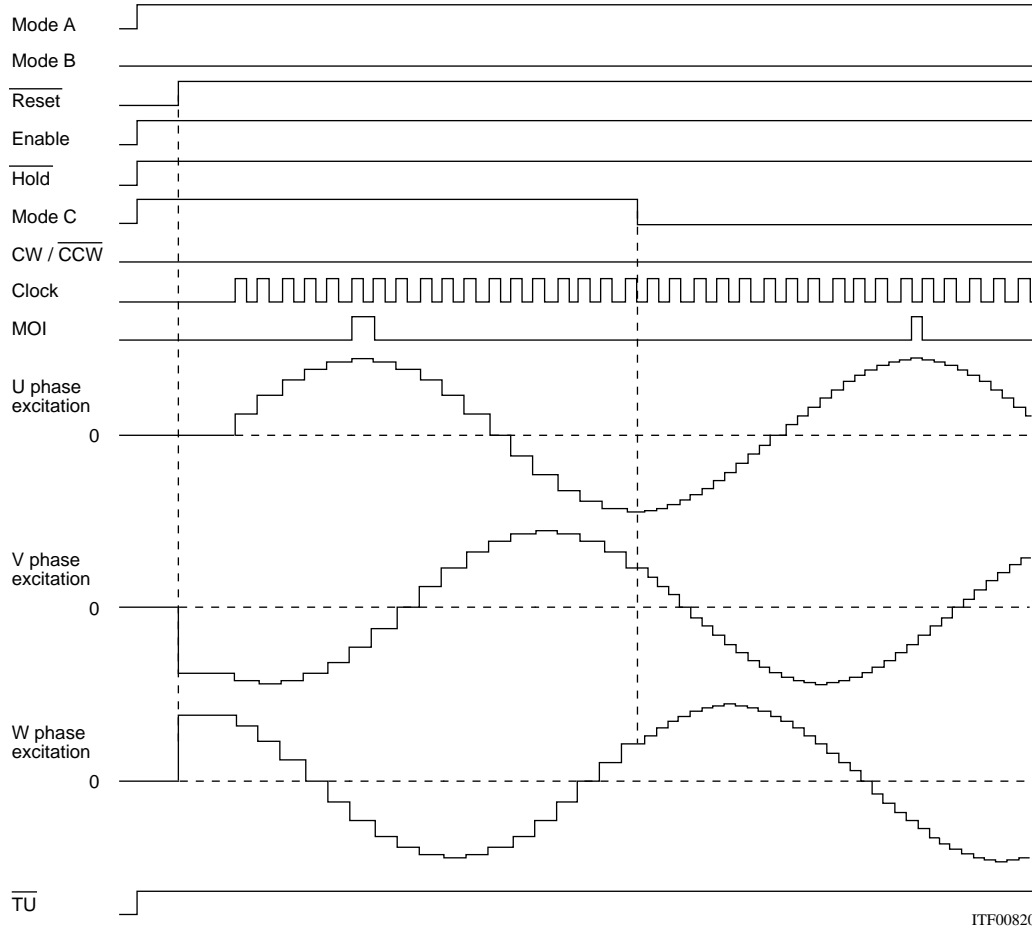

ITF00820

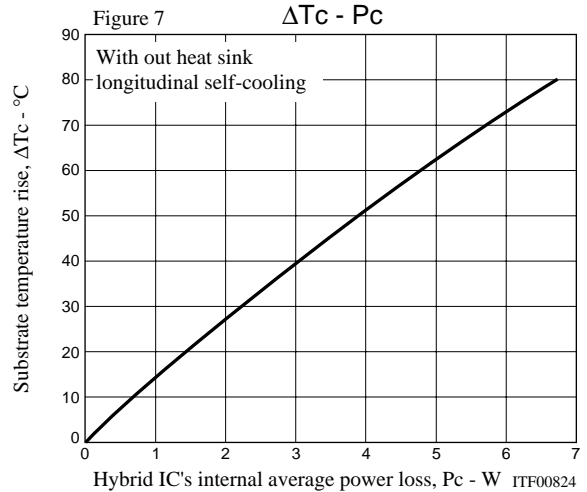
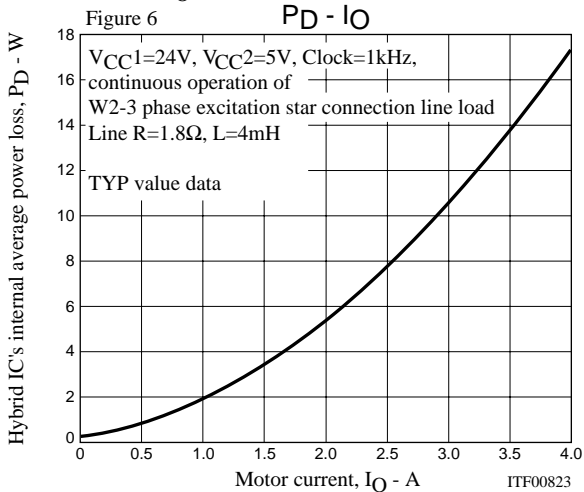
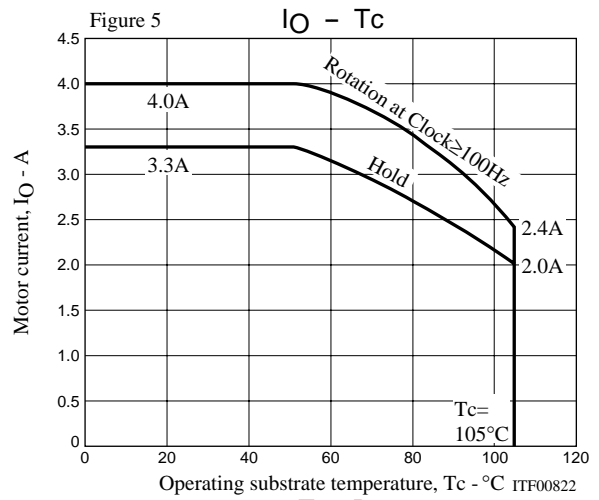
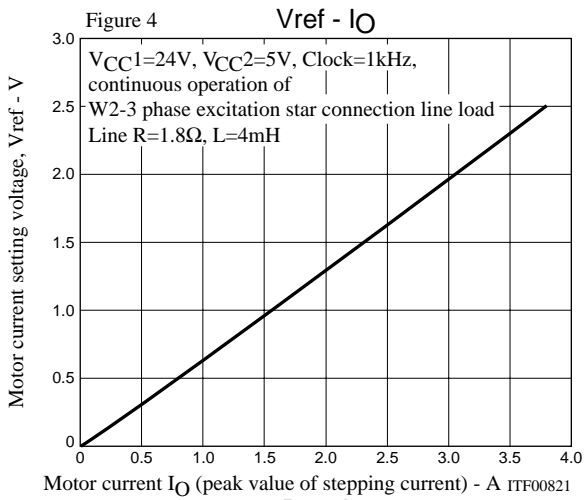

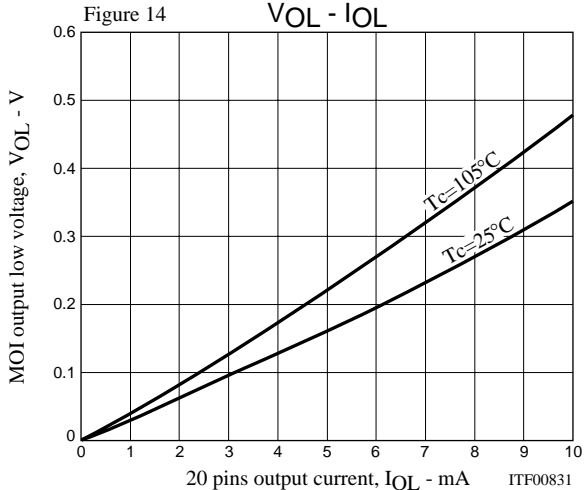
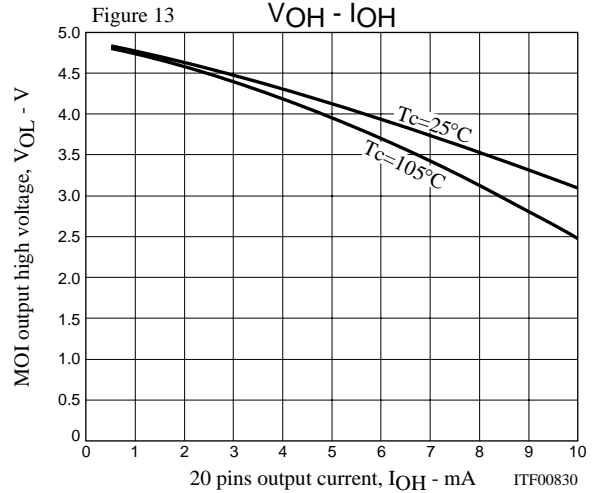
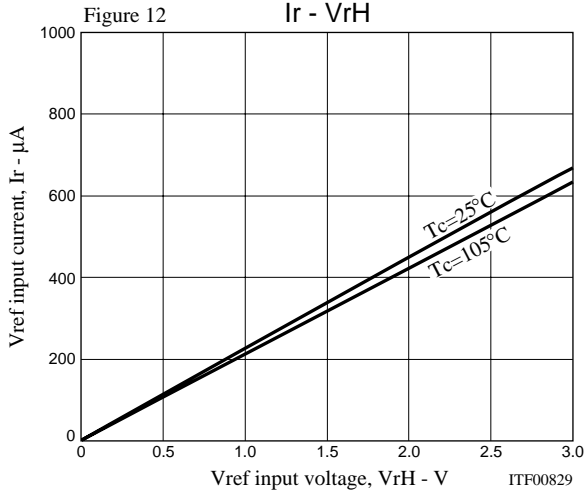
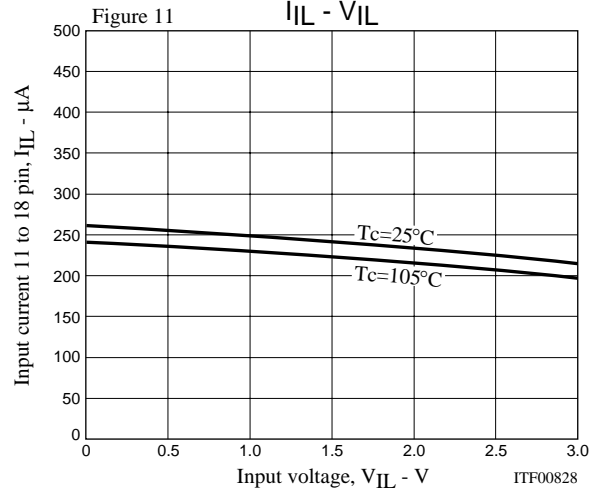
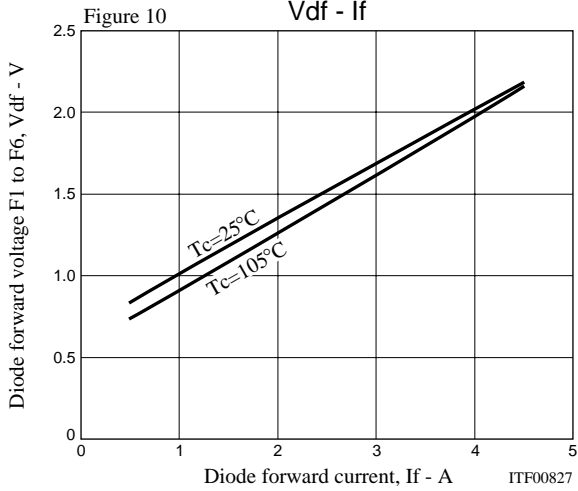
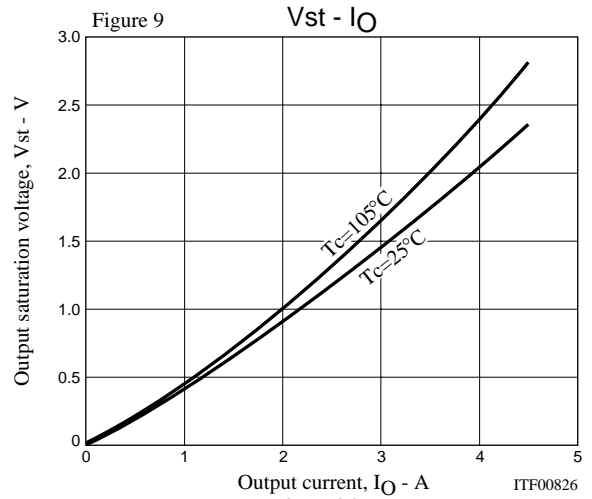
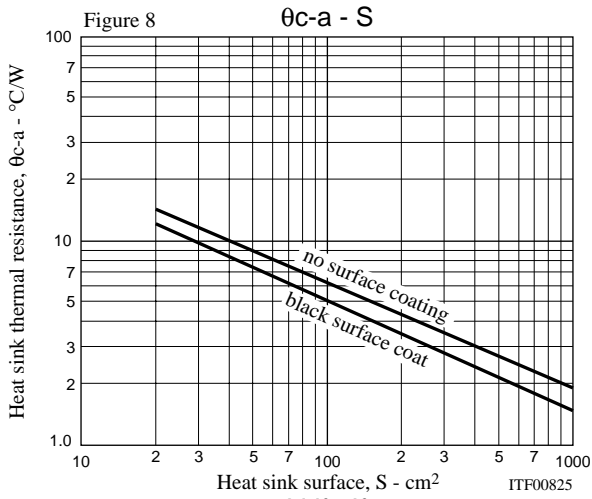

- SANYO Semiconductor Co.,Ltd. assumes no responsibility for equipment failures that result from using products at values that exceed, even momentarily, rated values (such as maximum ratings, operating condition ranges, or other parameters) listed in products specifications of any and all SANYO Semiconductor Co.,Ltd. products described or contained herein.
- SANYO Semiconductor Co.,Ltd. strives to supply high-quality high-reliability products, however, any and all semiconductor products fail or malfunction with some probability. It is possible that these probabilistic failures or malfunction could give rise to accidents or events that could endanger human lives, trouble that could give rise to smoke or fire, or accidents that could cause damage to other property. When designing equipment, adopt safety measures so that these kinds of accidents or events cannot occur. Such measures include but are not limited to protective circuits and error prevention circuits for safe design, redundant design, and structural design.
- In the event that any or all SANYO Semiconductor Co.,Ltd. products described or contained herein are controlled under any of applicable local export control laws and regulations, such products may require the export license from the authorities concerned in accordance with the above law.
- No part of this publication may be reproduced or transmitted in any form or by any means, electronic or mechanical, including photocopying and recording, or any information storage or retrieval system, or otherwise, without the prior written consent of SANYO Semiconductor Co.,Ltd.
- Any and all information described or contained herein are subject to change without notice due to product/technology improvement, etc. When designing equipment, refer to the "Delivery Specification" for the SANYO Semiconductor Co.,Ltd. product that you intend to use.
- Information (including circuit diagrams and circuit parameters) herein is for example only; it is not guaranteed for volume production.
- Upon using the technical information or products described herein, neither warranty nor license shall be granted with regard to intellectual property rights or any other rights of SANYO Semiconductor Co.,Ltd. or any third party. SANYO Semiconductor Co.,Ltd. shall not be liable for any claim or suits with regard to a third party's intellectual property rights which has resulted from the use of the technical information and products mentioned above.

This catalog provides information as of June, 2008. Specifications and information herein are subject to change without notice.