

No. STSE-CC7031A

<Cat.No.070309>

SPECIFICATIONS FOR NICHIA CHIP TYPE WARM WHITE LED

MODEL : NJSL036AT

NICHIA CORPORATION

1.SPECIFICATIONS

(1) Absolute Maximum Ratings (Ts=25°C)

| Item | Symbol | Absolute Maximum Rating | Unit |
|---------------------------|------------------|---|------|
| Forward Current | I _F | 650 | mA |
| Pulse Forward Current | I _{FP} | 900 | mA |
| Allowable Reverse Current | I _R | 85 | mA |
| Power Dissipation | P _D | 2.6 | W |
| Operating Temperature | T _{opr} | -40 ~ +100 | °C |
| Storage Temperature | T _{stg} | -40 ~ +100 | °C |
| Dice Temperature | T _j | 150 | °C |
| Soldering Temperature | T _{sld} | Reflow Soldering : 260°C for 10sec. Hand Soldering : 350°C for 3sec. | |

I_{FP} Conditions : Pulse Width ≤ 10msec. and Duty ≤ 1/10

(2) Initial Electrical/Optical Characteristics (Ts=25°C)

| Item | Symbol | Condition | Typ. | Max. | Unit | |
|-------------------------|----------------|-------------------------|-------------------------|------|------|---|
| Forward Voltage | V _F | I _F =350[mA] | (3.6) | 4.0 | V | |
| Luminous Flux | φ _v | I _F =350[mA] | (37) | - | lm | |
| Chromaticity Coordinate | x | - | I _F =350[mA] | 0.41 | - | - |
| | y | - | I _F =350[mA] | 0.39 | - | - |

* Please refer to CIE 1931 chromaticity diagram.

(3) Ranking (Ts=25°C)

| Item | Symbol | Condition | Min. | Max. | Unit | |
|---------------|----------|----------------|-------------------------|------|------|----|
| Luminous Flux | Rank P14 | φ _v | I _F =350[mA] | 51.0 | 60.5 | lm |
| | Rank P13 | | | 42.8 | 51.0 | |
| | Rank P12 | | | 36.0 | 42.8 | |
| | Rank P11 | | | 30.3 | 36.0 | |
| | Rank P10 | | | 25.5 | 30.3 | |

* Luminous Flux Measurement allowance is ± 7%.

Color Ranks (I_F=150mA, Ts=25°C)

| Rank d1 | | | | | | |
|---------|--------|--------|--------|--------|--------|--------|
| x | 0.3575 | 0.3610 | 0.3780 | 0.3988 | 0.3897 | 0.3720 |
| y | 0.3612 | 0.3850 | 0.3970 | 0.4116 | 0.3823 | 0.3714 |

| Rank d2 | | | | | | |
|---------|--------|--------|--------|--------|--------|--------|
| x | 0.3545 | 0.3575 | 0.3720 | 0.3897 | 0.3822 | 0.3667 |
| y | 0.3408 | 0.3612 | 0.3714 | 0.3823 | 0.3580 | 0.3484 |

| Rank e1 | | | | | | |
|---------|--------|--------|--------|--------|--------|--------|
| x | 0.3897 | 0.3988 | 0.4162 | 0.4390 | 0.4255 | 0.4053 |
| y | 0.3823 | 0.4116 | 0.4200 | 0.4310 | 0.4000 | 0.3907 |

| | Rank e2 | | | | | |
|---|---------|--------|--------|--------|--------|--------|
| x | 0.3822 | 0.3897 | 0.4053 | 0.4255 | 0.4129 | 0.3954 |
| y | 0.3580 | 0.3823 | 0.3907 | 0.4000 | 0.3725 | 0.3642 |

| | Rank f3 | | | |
|---|---------|--------|--------|--------|
| x | 0.4255 | 0.4390 | 0.4680 | 0.4519 |
| y | 0.4000 | 0.4310 | 0.4385 | 0.4086 |

| | Rank f4 | | | |
|---|---------|--------|--------|--------|
| x | 0.4519 | 0.4680 | 0.4970 | 0.4770 |
| y | 0.4086 | 0.4385 | 0.4466 | 0.4137 |

| | Rank f5 | | | |
|---|---------|--------|--------|--------|
| x | 0.4129 | 0.4255 | 0.4519 | 0.4355 |
| y | 0.3725 | 0.4000 | 0.4086 | 0.3785 |

| | Rank f6 | | | |
|---|---------|--------|--------|--------|
| x | 0.4355 | 0.4519 | 0.4770 | 0.4588 |
| y | 0.3785 | 0.4086 | 0.4137 | 0.3838 |

* Color Coordinates Measurement allowance is ± 0.01 .

Correspondence table of Color Coordinates – Luminous Flux ranks

| Ranking by Color Coordinates \ Ranking by Luminous Flux | P10 | P11 | P12 | P13 | P14 |
|---|-----|-----|-----|-----|-----|
| d1, d2, e1, e2 | | | | | |
| f3, f4, f5, f6 | | | | | |

* Shaded ranks are available.

2.INITIAL OPTICAL/ELECTRICAL CHARACTERISTICS

Please refer to figure's page.

3.OUTLINE DIMENSIONS AND MATERIALS

Please refer to figure's page.

Material as follows ; Package : Ceramics
 Encapsulating Resin : Silicone Resin (with Diffused + Phosphor)
 Electrodes : Au Plating

4.PACKAGING

· The LEDs are packed in cardboard boxes after taping.

Please refer to figure's page.

The label on the minimum packing unit shows ; Part Number, Lot Number, Ranking, Quantity

- In order to protect the LEDs from mechanical shock, we pack them in cardboard boxes for transportation.
- The LEDs may be damaged if the boxes are dropped or receive a strong impact against them, so precautions must be taken to prevent any damage.
- The boxes are not water resistant and therefore must be kept away from water and moisture.
- When the LEDs are transported, we recommend that you use the same packing method as Nichia.

5.LOT NUMBER

The first six digits number shows **lot number**.

The lot number is composed of the following characters;

○□×××× - △■

- - Year (6 for 2006, 7 for 2007)
- - Month (1 for Jan., 9 for Sep., A for Oct., B for Nov.)
- ×××× - Nichia's Product Number
- △ - Ranking by Color Coordinates
- - Ranking by Luminous Flux

6.RELIABILITY

(1) TEST ITEMS AND RESULTS

| Test Item | Standard Test Method | Test Conditions | Note | Number of Damaged |
|---|--------------------------|---|------------------------------|-------------------|
| Resistance to Soldering Heat (Reflow Soldering) | JEITA ED-4701 300 301 | Tsld=260°C, 10sec. (Pre treatment 30°C,70%,168hrs.) | 2 times | 0/22 |
| Solderability (Reflow Soldering) | JEITA ED-4701 300 303 | Tsld=215 ± 5°C, 3sec. (Lead Solder) | 1 time over 95% | 0/22 |
| Thermal Shock | JEITA ED-4701 300 307 | -40°C ~ 100°C 1min. (10sec.) 1min. (Pre treatment 30°C,70%,168hrs.) | 100 cycles | 0/50 |
| Temperature Cycle | JEITA ED-4701 100 105 | -40°C ~ 25°C ~ 100°C ~ 25°C 30min. 5min. 30min. 5min. | 100 cycles | 0/50 |
| Moisture Resistance Cyclic | JEITA ED-4701 200 203 | 25°C ~ 65°C ~ -10°C 90%RH 24hrs./1cycle | 10 cycles | 0/50 |
| High Temperature Storage | JEITA ED-4701 200 201 | Ta=100°C | 1000 hrs. | 0/50 |
| Temperature Humidity Storage | JEITA ED-4701 100 103 | Ta=60°C, RH=90% | 1000 hrs. | 0/50 |
| Low Temperature Storage | JEITA ED-4701 200 202 | Ta=-40°C | 1000 hrs. | 0/50 |
| Steady State Operating Life | | Ta=25°C, IF=650mA Tested with Nichia standard circuit board.* | 1000 hrs. | 0/50 |
| Steady State Operating Life of High Temperature | | Ta=100°C, IF=250mA Tested with Nichia standard circuit board.* | 1000 hrs. | 0/50 |
| Steady State Operating Life of High Humidity Heat | | 60°C, RH=90%, IF=500mA Tested with Nichia standard circuit board.* | 500 hrs. | 0/50 |
| Steady State Operating Life of Low Temperature | | Ta=-40°C, IF=350mA Tested with Nichia standard circuit board.* | 1000 hrs. | 0/50 |
| Permanence of Marking | JEITA ED-4701 500 501 | Solvent : Isopropyl Alcohol Solvent Temperature : 20 ~ 25°C Dipping Time : 5 min. | 1 time | 0/22 |
| Vibration | JEITA ED-4701 400 403 | 100 ~ 2000 ~ 100Hz Sweep 4min. 200m/s ² 3directions, 4cycles | 48min. | 0/10 |
| Electrostatic Discharges | JEITA ED-4701 300 304 | R=1.5kΩ, C=100pF Test Voltage=2kV | 3 times Negative/Positive | 0/22 |

* Thermal resistance of LED with Nichia standard circuit board : $R_{ja} \cong 45^{\circ}\text{C/W}$

Nichia standard circuit board : FR4, t=1.6mm, Copper foil, t=0.07mm

(2) CRITERIA FOR JUDGING DAMAGE

| Item | Symbol | Test Conditions | Criteria for Judgement | |
|-----------------|----------------|-----------------------|------------------------|---------------------|
| | | | Min. | Max. |
| Forward Voltage | V _F | I _F =350mA | - | Initial Level × 1.1 |
| Luminous Flux | φ _v | I _F =350mA | Initial Level × 0.7 | - |

* The test is performed after the board is cooled down to the room temperature.

7.CAUTIONS

The LEDs are devices which are materialized by combining Blue LEDs and special phosphors.

Consequently, the color of the LEDs is changed a little by an operating current.

Care should be taken after due consideration when using LEDs.

(1) Moisture Proof Package

- When moisture is absorbed into the SMT package it may vaporize and expand during soldering. There is a possibility that this can cause exfoliation of the contacts and damage the optical characteristics of the LEDs. For this reason, the moisture proof package is used to keep moisture to a minimum in the package.
- The moisture proof package is made of an aluminum moisture proof bag. A package of a moisture absorbent material (silica gel) is inserted into the aluminium moisture proof bag. The silica gel changes its color from blue to pink as it absorbs moisture.

(2) Storage

· Storage Conditions

Before opening the package :

The LEDs should be kept at 30°C or less and 90%RH or less. The LEDs should be used within a year. When storing the LEDs, moisture proof packaging with absorbent material (silica gel) is recommended.

After opening the package :

The LEDs should be kept at 30°C or less and 70%RH or less. The LEDs should be soldered within 168 hours (7days) after opening the package. If unused LEDs remain, they should be stored in the moisture proof packages, such as sealed containers with packages of moisture absorbent material (silica gel). It is also recommended to return the LEDs to the original moisture proof bag and to reseal the moisture proof bag again.

- If the moisture absorbent material (silica gel) has faded away or the LEDs have exceeded the storage time, baking treatment should be performed using the following condition.

Baking treatment : more than 24 hours at $65 \pm 5^{\circ}\text{C}$

- Nichia LED electrodes are gold plated. The gold surface may be affected by environments which contain corrosive substances. Please avoid conditions which may cause the LED to corrode, tarnish or discolor. This corrosion or discoloration may cause difficulty during soldering operations. It is recommended that the User use the LEDs as soon as possible.
- Please avoid rapid transitions in ambient temperature, especially in high humidity environments where condensation can occur.

(3) Static Electricity

- Static electricity or surge voltage damages the LEDs.

It is recommended that a wrist band or an anti-electrostatic glove be used when handling the LEDs.

- All devices, equipment and machinery must be properly grounded. It is recommended that precautions be taken against surge voltage to the equipment that mounts the LEDs.
- When inspecting the final products in which LEDs were assembled, it is recommended to check whether the assembled LEDs are damaged by static electricity or not. It is easy to find static-damaged LEDs by a light-on test or a VF test at a lower current (below 1mA is recommended).
- Damaged LEDs will show some unusual characteristics such as the forward voltage becomes lower, or the LEDs do not light at the low current.

Criteria : (VF > 2.0V at IF=0.5mA)

(4) Designing the position of LED on a board.

- No twist / warp / bent / or other stress shall be applied to the board after mounting LED with solder to avoid a crack of LED package.

Refer to the following recommended position and direction of LED.

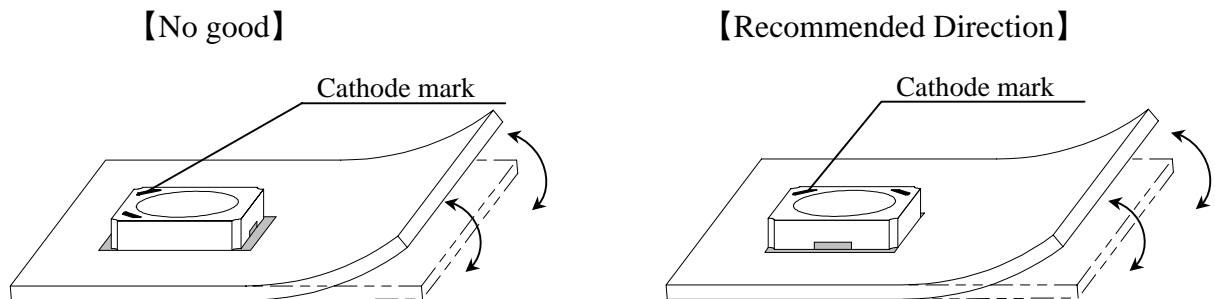

Appropriate LED mounting is to place perpendicularly against the stress affected side.

- Depending on the position and direction of LED, the mechanical stress on the LED package can be changed. Refer to the following figure.

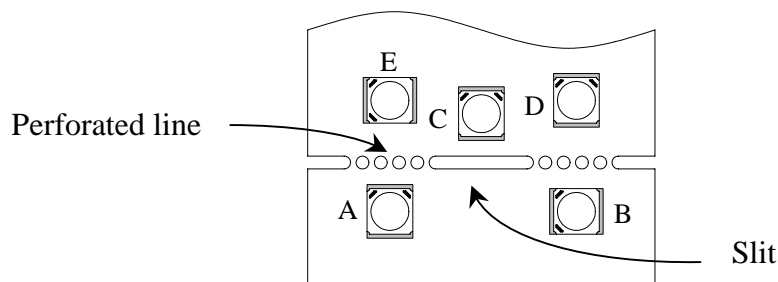

Stress : $A > B = C > D > E$

- Do not split board by hand. Split with exclusive special tool.
- If an aluminum circuit board is used, a large stress by thermal shock might cause a solder crack. For this reason, it is recommended an appropriate verification should be taken before use.

(5) Soldering Conditions

- The LEDs can be soldered in place using the reflow soldering method. Nichia cannot make a guarantee on the LEDs after they have been assembled using the dip soldering method.
- Recommended soldering conditions

| | Reflow Soldering | | Hand Soldering | |
|------------------|--------------------------------------|---|--|----------------|
| | Lead Solder | Lead-free Solder | Temperature | Soldering time |
| Pre-heat | 120 ~ 150°C | 180 ~ 200°C | 350°C Max. 3 sec. Max. (one time only) | |
| Pre-heat time | 120 sec. Max. | 120 sec. Max. | | |
| Peak temperature | 240°C Max. | 260°C Max. | | |
| Soldering time | 10 sec. Max. | 10 sec. Max. | | |
| Condition | refer to Temperature - profile ①. | refer to Temperature - profile ②. (N ₂ reflow is recommended.) | | |

* Although the recommended soldering conditions are specified in the above table, reflow or hand soldering at the lowest possible temperature is desirable for the LEDs.

* A rapid-rate process is not recommended for cooling the LEDs down from the peak temperature. [Temperature-profile (Surface of circuit board)] Use the conditions shown to the under figure.

<① : Lead Solder>

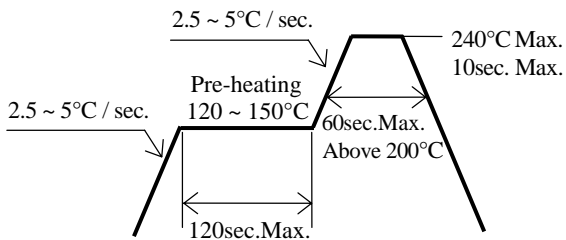

<② : Lead-free Solder>

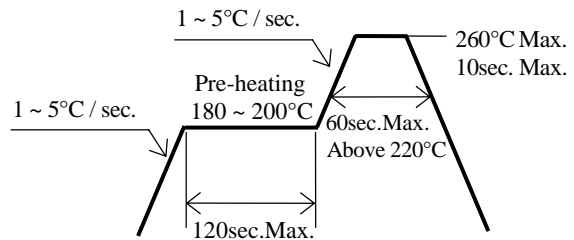

[Recommended soldering pad design]

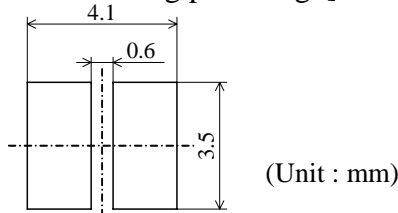

Use the following conditions shown in the figure.

- Occasionally there is a brightness decrease caused by the influence of heat or ambient atmosphere during air reflow. It is recommended that the User use the nitrogen reflow method.
- The encapsulated material of the LEDs is silicone. Therefore the LEDs have a soft surface on the top of package. The pressure to the top surface will be influence to the reliability of the LEDs. Precautions should be taken to avoid the strong pressure on the encapsulated part. So when using the chip mounter, the picking up nozzle that does not affect the silicone resin should be used.
- Repairing should not be done after the LEDs have been soldered. When repairing is unavoidable, a double-head soldering iron should be used. It should be confirmed beforehand whether the characteristics of the LEDs will or will not be damaged by repairing.
- Reflow soldering should not be done more than two times.
- When soldering, do not put stress on the LEDs during heating.

(6) Cleaning

- It is recommended that isopropyl alcohol be used as a solvent for cleaning the LEDs. When using other solvents, it should be confirmed beforehand whether the solvents will dissolve the package and the resin or not. Freon solvents should not be used to clean the LEDs because of worldwide regulations.
- Do not clean the LEDs by the ultrasonic. When it is absolutely necessary, the influence of ultrasonic cleaning on the LEDs depends on factors such as ultrasonic power and the assembled condition. Before cleaning, a pre-test should be done to confirm whether any damage to the LEDs will occur.

(7) Heat Generation

- Thermal design of the end product is of paramount importance. Please consider the heat generation of the LED when making the system design. The coefficient of temperature increase per input electric power is affected by the thermal resistance of the circuit board and density of LED placement on the board, as well as other components. It is necessary to avoid intense heat generation and operate within the maximum ratings given in this specification.
- Please determine the operating current with consideration of the ambient temperature local to the LED and refer to the plot of Ambient temperature vs. Allowable Forward Current on CHARACTERISTICS in this specifications. Please also take measures to remove heat from the area near the LED to improve the operational characteristics of the LED.
- The equation ① indicates correlation between T_j and T_a , and the equation ② indicates correlation between T_j and T_s .

$$T_j = T_a + R_{ja} \cdot W \quad \text{..... ①} \qquad T_j = T_s + R_{js} \cdot W \quad \text{..... ②}$$

- * T_j = Dice Temperature : °C, T_a = Ambient Temperature : °C,
- T_s = Solder Temperature (Cathode Side) : °C,
- R_{ja} = Heat resistance from Dice to Ambient temperature : °C /W,
- R_{js} = Heat resistance from Dice to T_s measuring point \cong 30°C /W,
- W = Inputting Power ($I_F \times V_F$) : W

(8) Others

- NJS036A complies with RoHS Directive.
- The LED light output is strong enough to injure human eyes. Precautions must be taken to prevent looking directly at the LEDs with unaided eyes for more than a few seconds.
- Flashing lights have been known to cause discomfort in people; you can prevent this by taking precautions during use. Also, people should be cautious when using equipment that has had LEDs incorporated into it.
- The LEDs described in this brochure are intended to be used for ordinary electronic equipment (such as office equipment, communications equipment, measurement instruments and household appliances). Consult Nichia's sales staff in advance for information on the applications in which exceptional quality and reliability are required, particularly when the failure or malfunction of the LEDs may directly jeopardize life or health (such as for airplanes, aerospace, submersible repeaters, nuclear reactor control systems, automobiles, traffic control equipment, life support systems and safety devices).
- User shall not reverse engineer by disassembling or analysis of the LEDs without having prior written consent from Nichia. When defective LEDs are found, the User shall inform Nichia directly before disassembling or analysis.
- The formal specifications must be exchanged and signed by both parties before large volume purchase begins.
- The appearance and specifications of the product may be modified for improvement without notice.

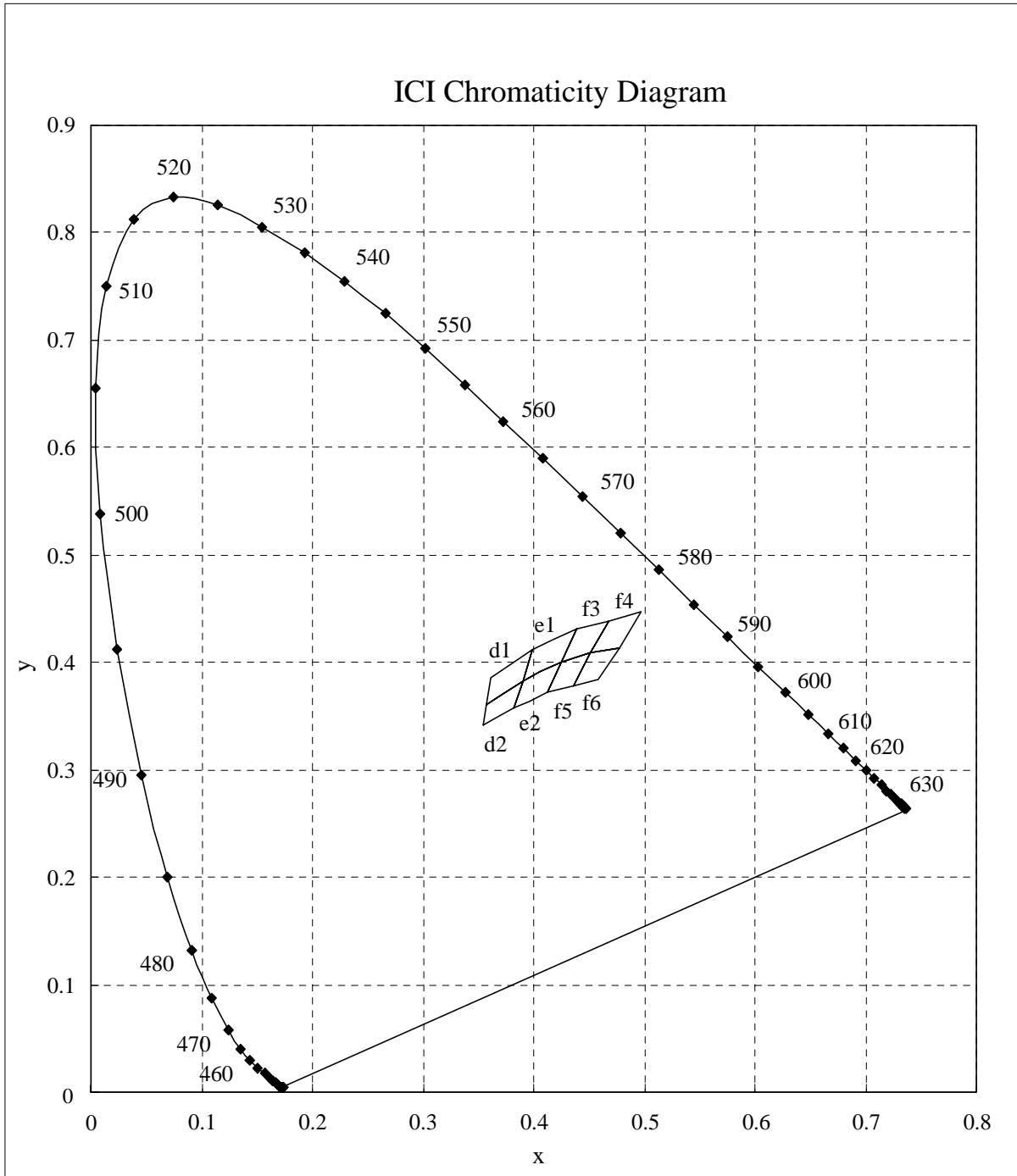

* Color Coordinates Measurement allowance is ± 0.01 .

■ Forward Voltage vs. Forward Current

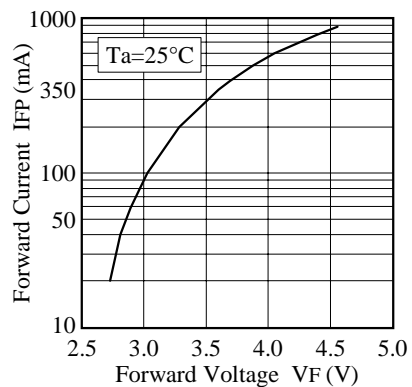

■ Forward Current vs. Relative Luminous Flux

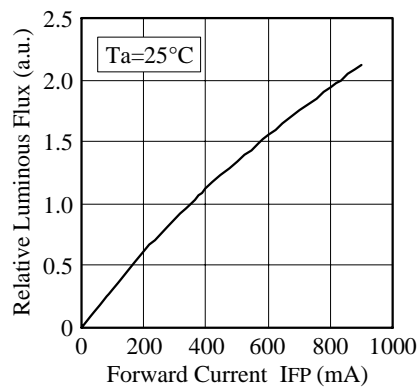

■ Duty Ratio vs. Allowable Forward Current

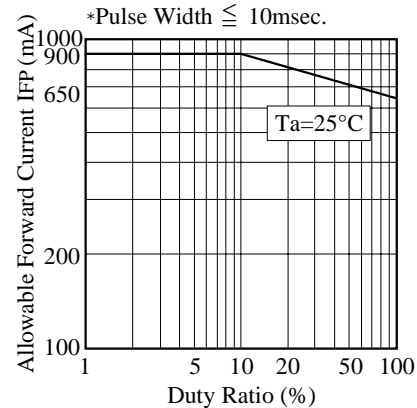

■ Forward Current vs. Luminous Efficiency

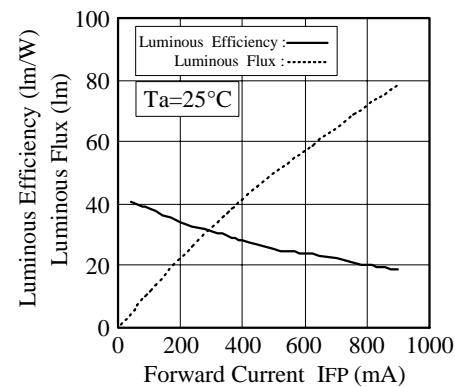

■ Ambient Temperature vs. Forward Voltage

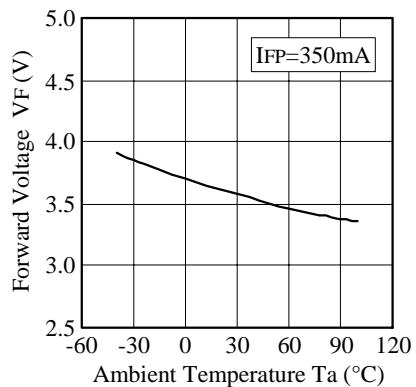

■ Ambient Temperature vs. Relative Luminous Flux

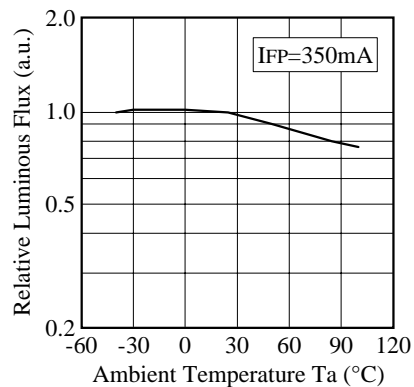

■ Ambient Temperature vs. Allowable Forward Current

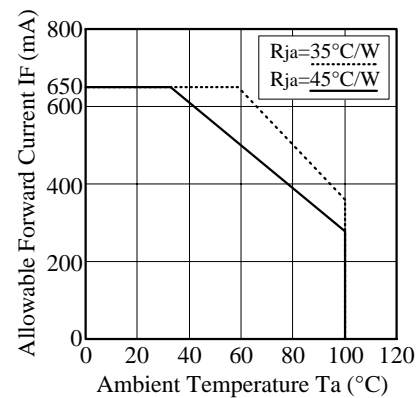

| | | |
|---------------------------|-------|-----------------|
| NICHIA CORPORATION | Model | NJSL036A |
| | Title | CHARACTERISTICS |
| | No. | 070227762151 |

■ Forward Current vs. Chromaticity Coordinate

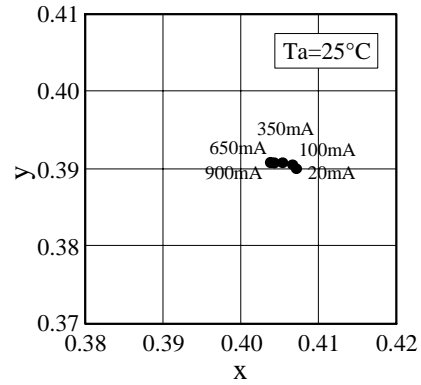

■ Spectrum

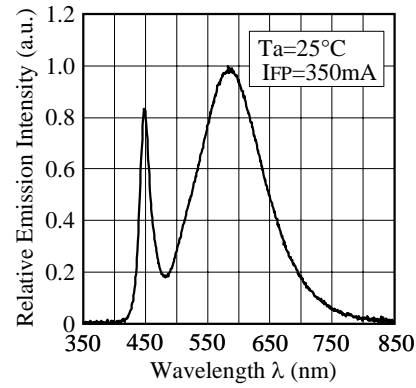

■ Ambient Temperature vs. Chromaticity Coordinate

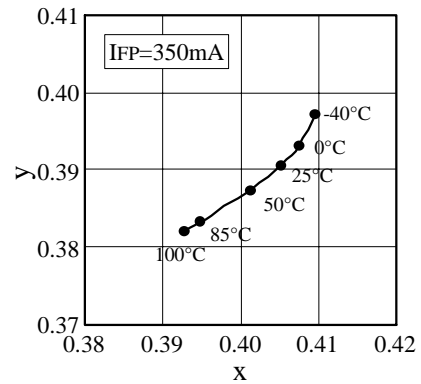

■ Directivity

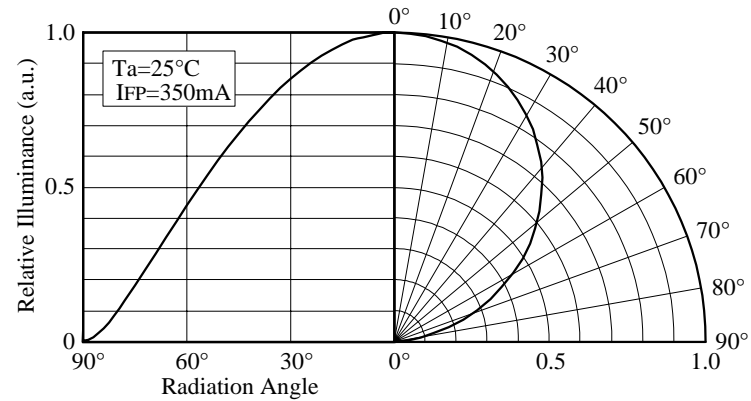

| | | |
|---------------------------|-------|-----------------|
| NICHIA CORPORATION | Model | NJSL036A |
| | Title | CHARACTERISTICS |
| | No. | 070227762161 |

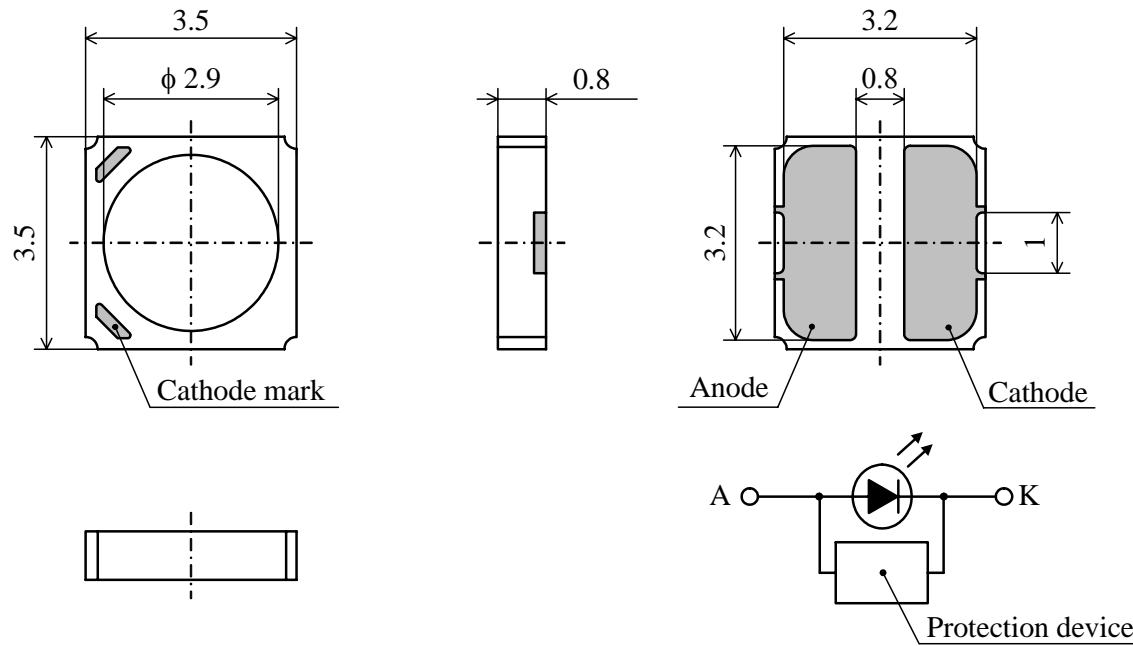

| ITEM | MATERIALS |
|---------------------|---|
| PACKAGE | Ceramics |
| ENCAPSULATING RESIN | Silicone Resin (with Diffused + Phosphor) |
| ELECTRODES | Au Plating |

* NJSL036A has a protection device built in as a protection circuit against static electricity.

| | | | |
|--------------------|-------|--------------------|----------------------------|
| NICHIA CORPORATION | Model | NJSL036A | Unit mm 8/1 Scale |
| | Title | OUTLINE DIMENSIONS | |
| | No. | 070227762171 | Allow ±0.2 |

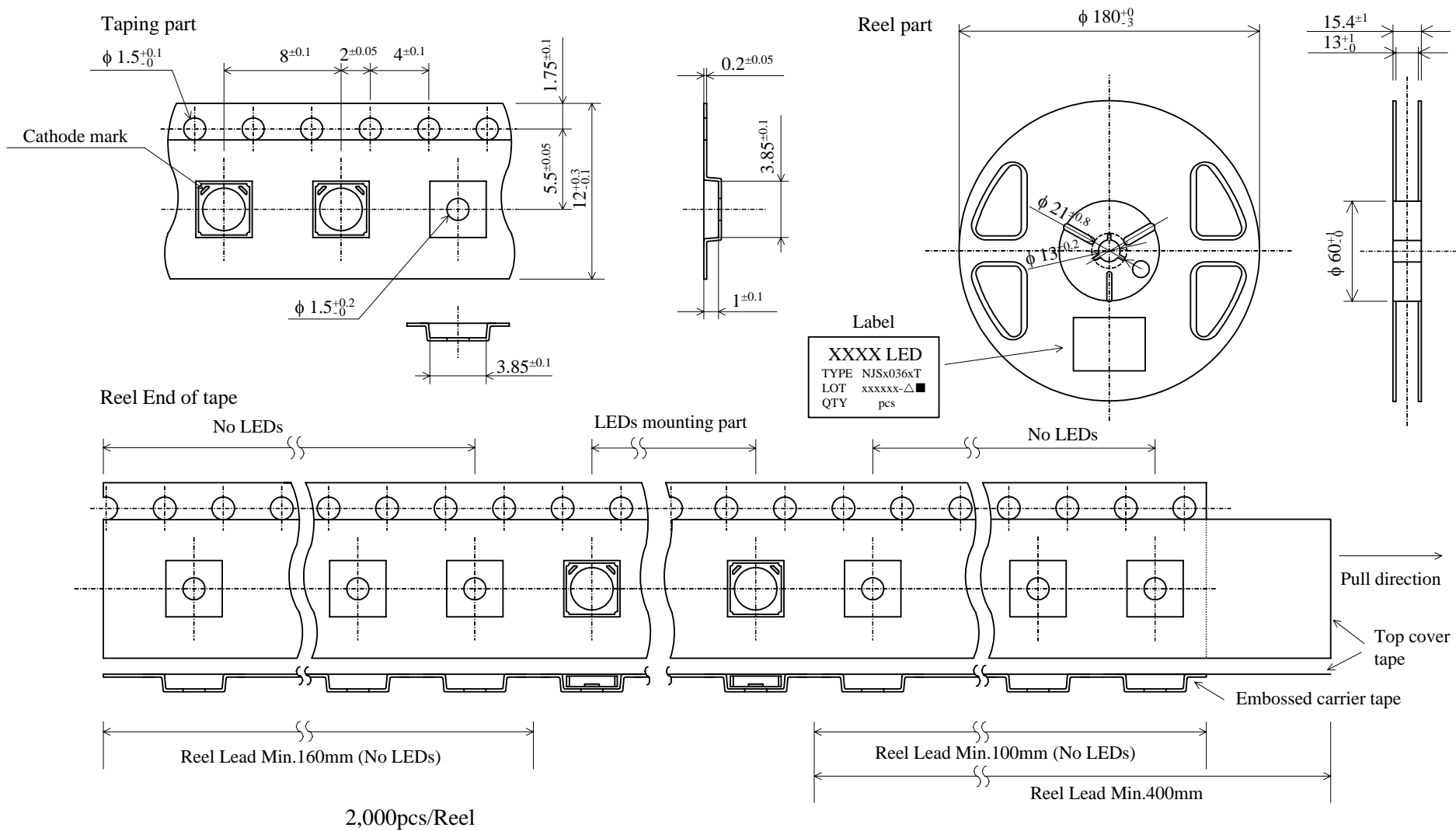

Taping is based on the **JIS C 0806** : Packaging of Electronic Components on Continuous Tapes.

| | | | |
|---------------------------|-------|-------------------|----------------|
| NICHIA CORPORATION | Model | NJSx036xT | Unit mm |
| | Title | TAPING DIMENSIONS | |
| | No. | 070216654602 | Scale Allow |

The reel and moisture absorbent material are put in the moisture proof foil bag and then heat sealed.

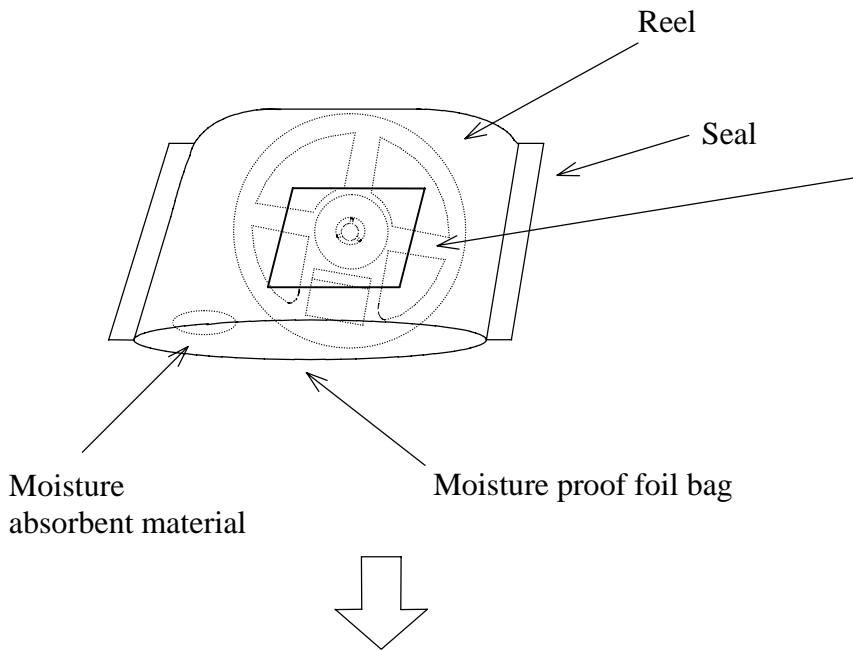

Label

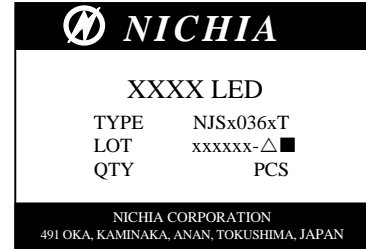

The box is partitioned with the cardboard.

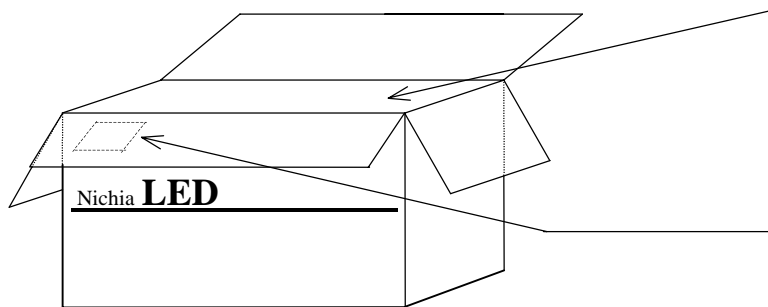

Label



Packing unit

| | Reel/bag | Quantity/bag (pcs) |
|-------------------------|----------|--------------------|
| Moisture proof foil bag | 1reel | 2,000 MAX. |

| Cardboard box | Dimensions (mm) | Reel/box | Quantity/box (pcs) |
|-----------------|-----------------|-------------|--------------------|
| Cardboard box S | 291×237×120×8t | 5reel MAX. | 10,000 MAX. |
| Cardboard box M | 259×247×243×5t | 10reel MAX. | 20,000 MAX. |
| Cardboard box L | 444×262×259×8t | 20reel MAX. | 40,000 MAX. |

| | | | |
|---------------------------|-------|--------------|---|
| NICHIA CORPORATION | Model | NJSx036xT | / |
| | Title | PACKING | |
| | No. | 070216654612 | |