

Typical units

FEATURES

- Small size, minimal footprint – SMT/SIP package
- 5A Output Current (all voltages)
- High Efficiency: up to 92%
- High reliability
- RoHS Compliant
- Cost efficient open frame design
- Output voltage programmable by an external resistor
- Independently regulated +3.3V, +5.1V and +12V outputs
- Monotonic Start with Pre-bias

Output						Input			Efficiency
V _{OUT} (Volts)	I _{OUT} (Amps)	PARD (mVp-p)		Regulation (Max.)		V _{IN} Nom. (V)	Range (V)	I _{IN} Typ. (A)	Full Load
		Typ.	Max.	Line	Load				
0.75	5	30	50	±0.02%	±0.5%	12	8.3–14	0.428	73%
1.2	5	30	50	±0.02%	±0.5%	12	8.3–14	0.625	80%
1.5	5	30	50	±0.02%	±0.5%	12	8.3–14	0.762	82%
1.8	5	30	50	±0.02%	±0.5%	12	8.3–14	0.893	84%
2.0	5	30	50	±0.02%	±0.5%	12	8.3–14	0.980	85%
2.5	5	30	50	±0.02%	±0.5%	12	8.3–14	1.197	87%
3.3	5	30	50	±0.02%	±0.5%	12	8.3–14	1.545	89%
5.0	5	45	75	±0.02%	±0.5%	12	8.3–14	2.264	92%



For full details go to
www.murata-ps.com/rohs

Performance Specifications and Ordering Guide

Input Characteristics					
Input Characteristics	Notes and Conditions	Min.	Type	Max.	Units
Input Voltage Operating Range		8.3	12	14	Vdc
Input Reflected Ripple Current			200		mA p-p
Inrush Current Transient				0.2	A ² s
Input Filter Type (external)	47μF/20V Tantalum & 10μF/15V Ceramic		57		μF
Input Turn ON Threshold			8.0		V
Input Turn OFF Threshold			7.9		V
Enable (Positive enable has 20k pullup) (Negative enable has no internal pullup resistor)	Positive enable: ON		open		
	Positive enable: OFF		<0.4		Vdc
	Negative enable: ON; open circuit or		<0.4		Vdc
	Negative enable: OFF	2		V _{IN}	
Output Characteristics					
Output Characteristics	Notes and Conditions	Min.	Type	Max.	Units
V _{OUT} Accuracy	100% load	-1.5		+1.5	%
Output Loading		0		5	A
Output Ripple and Loading @ 20Mhz Bandwidth				75	mV
Maximum Capacitive Load	Low ESR			3000	μF
V _{OUT} Trim Range (nom)		0.75		5.0	V
Total Accuracy	Over line/load temperature		<2%		
Current Limit			8.5		A
Output Line Regulation		-0.2		+0.2	%
Output Load Regulation		-0.5		+0.5	%
Turn-on Overshoot				1	%
SC Protection Technique	Hiccup with auto recovery				
Pre-bias Start-up at output	Unit starts monotonically with Pre-bias				
Dynamic Characteristics					
Dynamic Characteristics	Notes and Conditions	Min.	Type	Max.	Units
Load Transient	50% step, 0.1A/μs Settling Time			200	mV
				200	μs
Frequency			300		KHz
Rise Time	10% V _o to 90% V _o		3.5		ms
Start-Up Time	V _{IN} to V _{OUT} and On/Off to V _{OUT} V _{OUT} rise to monotonic		7		ms

Performance Specifications and Ordering Guide (continued)

General Specifications	Notes and Conditions	Min.	Type	Max.	Units
MTBF	Calculated (MIL-HDBK-217F)		1.5		×10 ⁶ Hrs
Thermal Protection	Thermal Measurement locations (TML)		110		°C
Operating Temperature	Without derating, 200LFM	-40		50	°C
Operating Ambient Temperature	See Power Derating Curve	-40		85	°C
SIP Dimensions	0.9"L×0.4"W×0.22"H (22.9×10.16×5.6mm)				
SMT Dimensions	0.8"L×0.45"W×0.24"H (20.3×11.43×6.09mm)				
SIP Pin Dimensions	0.025" (0.64mm) square		0.64		mm
SIP Block Dimensions	0.090"L×0.062"W×0.062"H (0.64mm) square				
Pin and Block Material	Matte Sn finish on component leads				
Weight			2.3		g
Flammability Rating	UL94V-0				
Standards Compliance					
CSA C22.2, No.60950/UL 60950, Third edition (2000)					

Thermal Considerations

The power module operates in a variety of thermal environments; however, sufficient cooling should be provided to help ensure reliable operation of the unit.

The thermal data presented is based on measurements taken at various airflows. Note that airflow is parallel to the long axis of the module as shown in Figure 1 and derating applies accordingly.

As a rule of thumb however, we recommend to use a normal-blow or slow-blow fuse with a typical value of about twice the maximum input current, calculated at low line with the converter's minimum efficiency.

The temperature at the thermal measurement location (TML) should not exceed 110°C. The output power of the module should not exceed the rated power for the module (Vo,set x Io,max).

Convection Requirements for Cooling

To predict the approximate cooling needed for the module, refer to the Power Derating Curves in Figures 2–17.

These derating curve are approximations of the ambient temperature and airflow required to keep the power module temperature below it's maximum rating. Once the module is assembled in the actual system, the module's temperature should be verified.

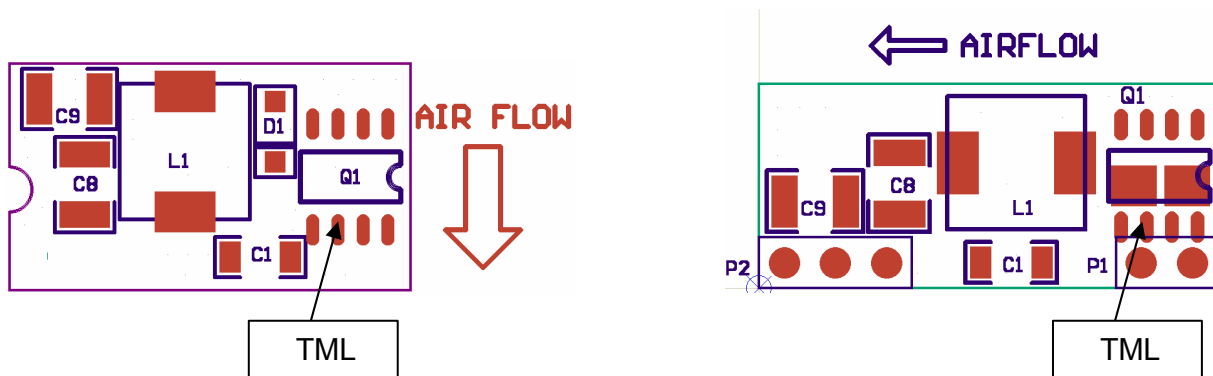

Figure 1. Thermal Tests Set-Up

Typical Derating Curves SIP/SMT Version

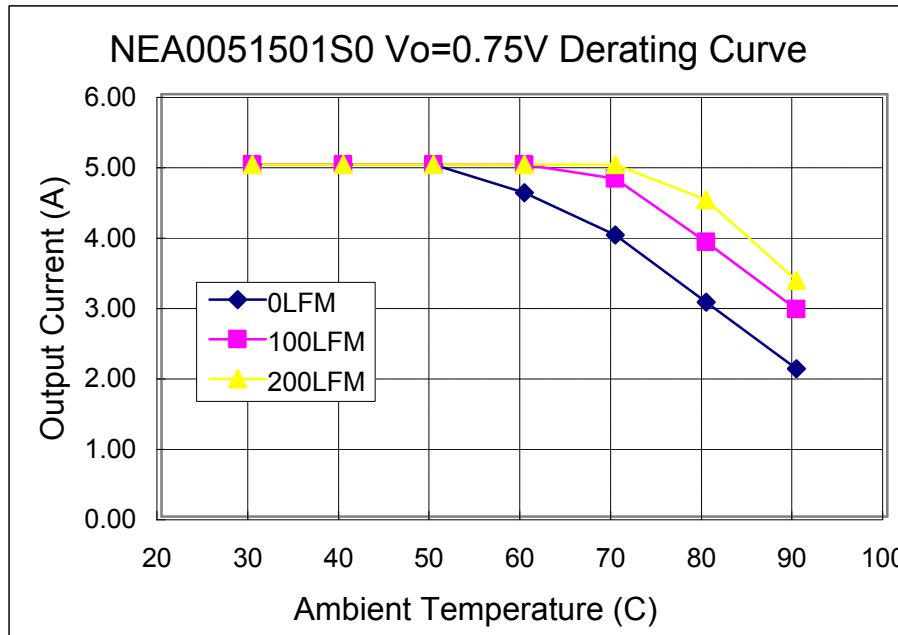

Fig. 2. SMT Power Derating vs Output Current for 12Vin 0.75V Out.

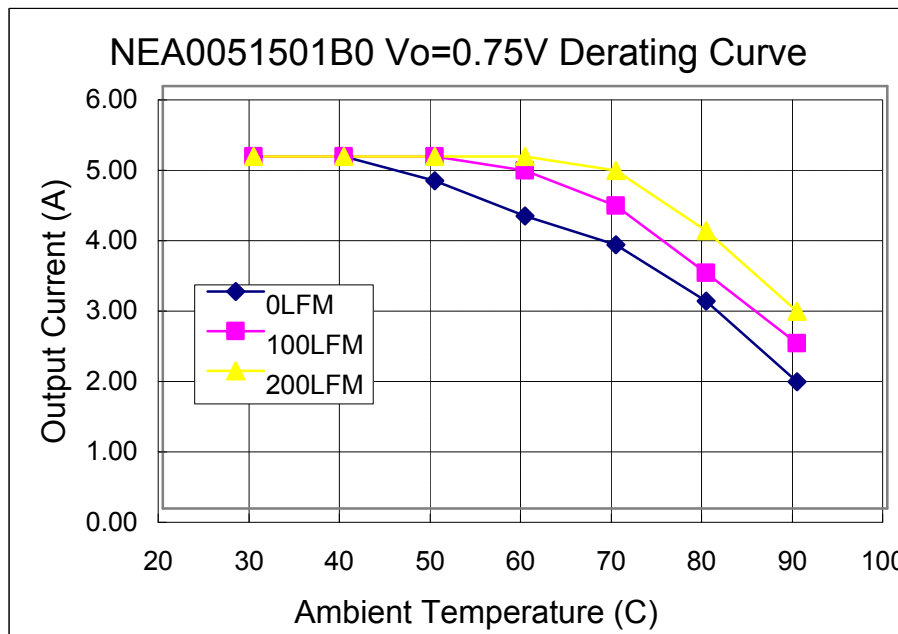

Fig. 3. SIP Power Derating vs Output Current for 12Vin 0.75V Out.

Typical Derating Curves SIP/SMT Version

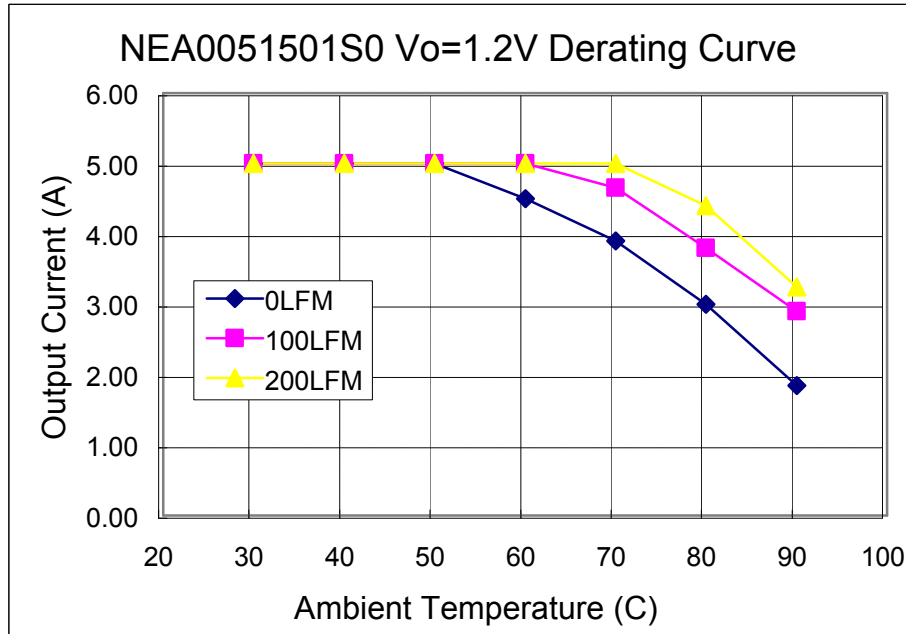

Fig 4. SMT Power Derating vs Output Current for 12Vin 1.2V Out.

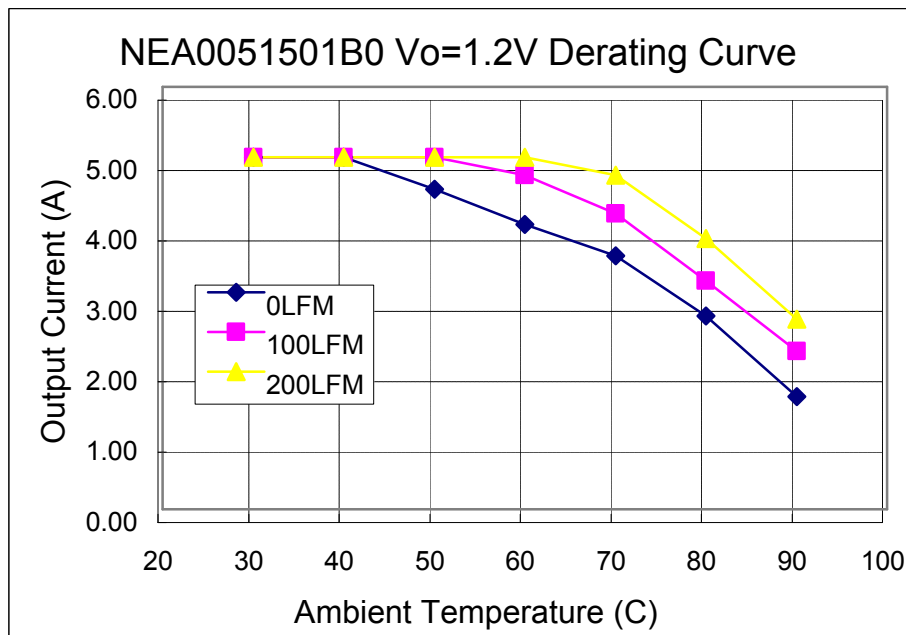

Fig 5. SIP Power Derating vs Output Current for 12Vin 1.2V Out.

Typical Derating Curves SIP/SMT Version

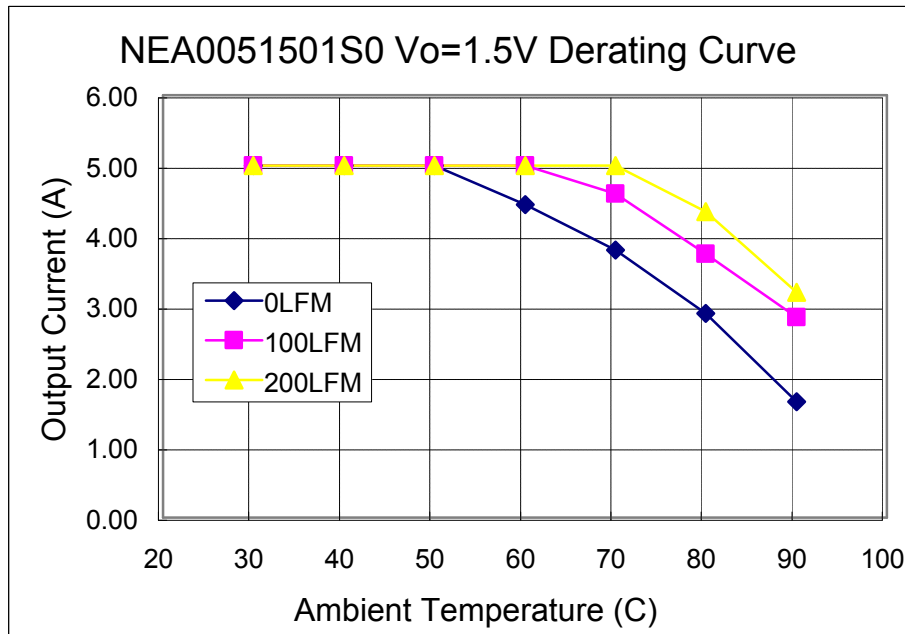

Fig 6. SMT Power Derating vs Output Current for 12Vin 1.5V Out.

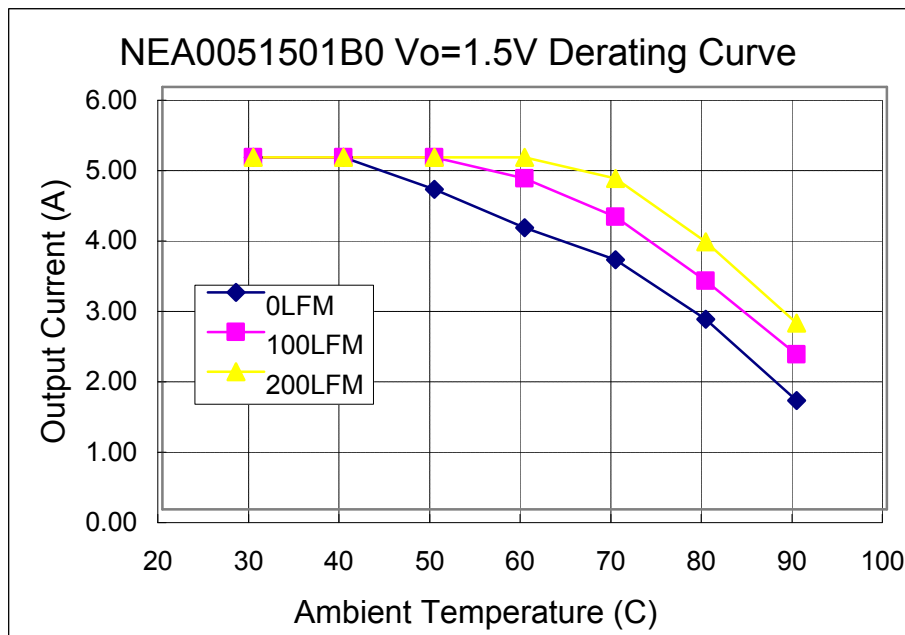

Fig 7. SIP Power Derating vs Output Current for 12Vin 1.5V Out.

Typical Derating Curves SIP/SMT Version

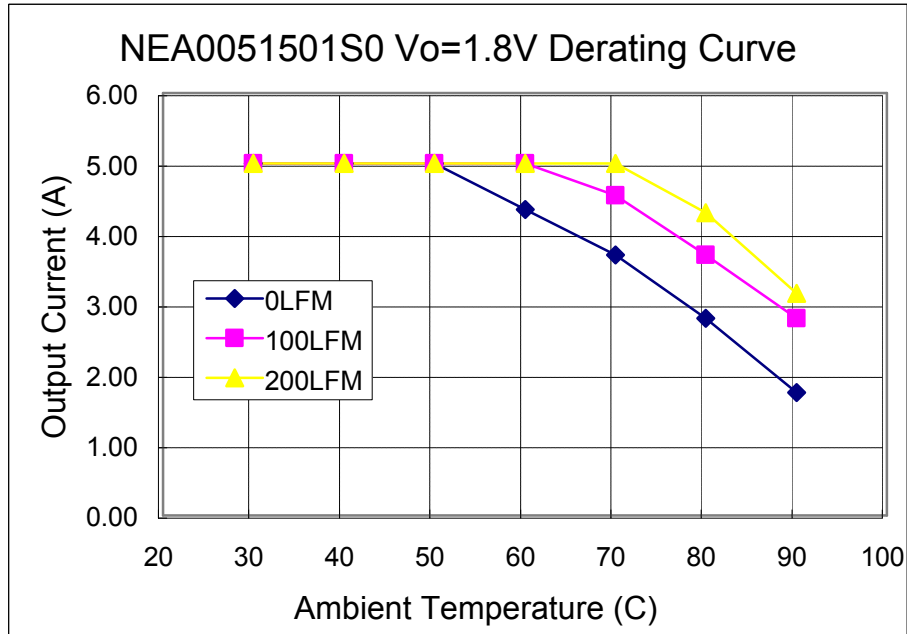

Fig 8. SMT Power Derating vs Output Current for 12Vin 1.8V Out.

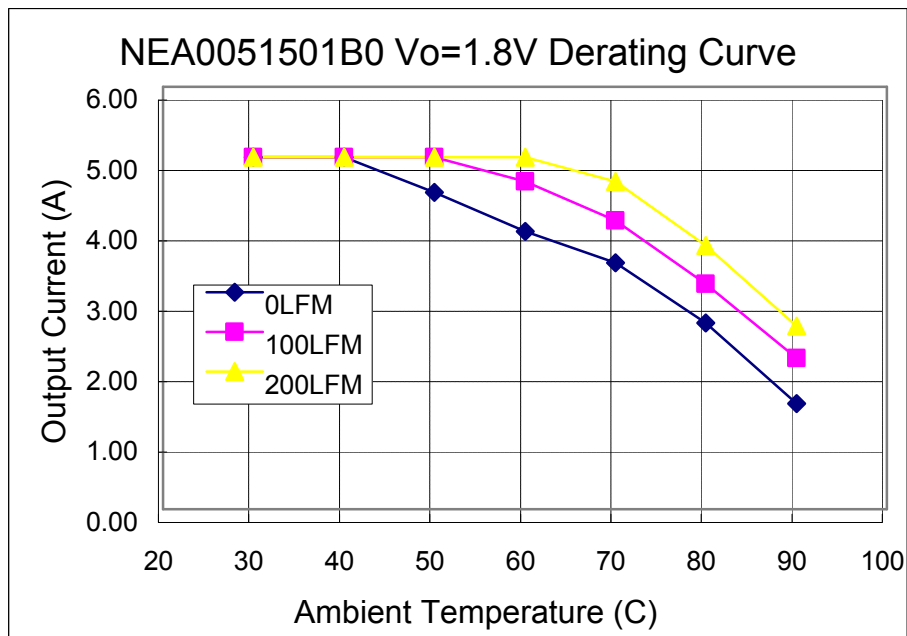

Fig 9. SIP Power Derating vs Output Current for 12Vin 1.8V Out.

Typical Derating Curves SIP/SMT Version

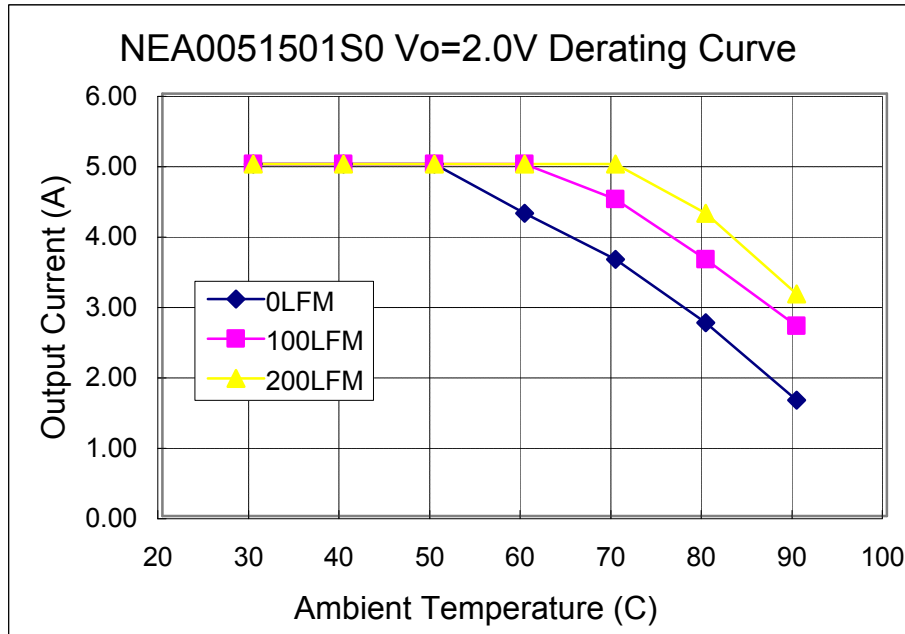

Fig 10. SMT Power Derating vs Output Current for 12Vin 2.0V Out.

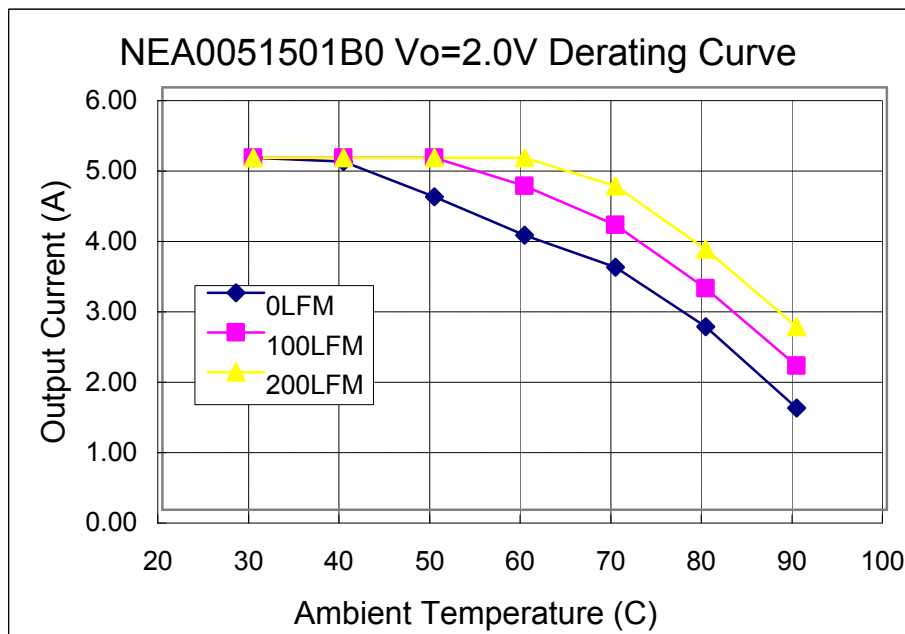

Fig 11. SIP Power Derating vs Output Current for 12Vin 2.0V Out.

Typical Derating Curves SIP/SMT Version

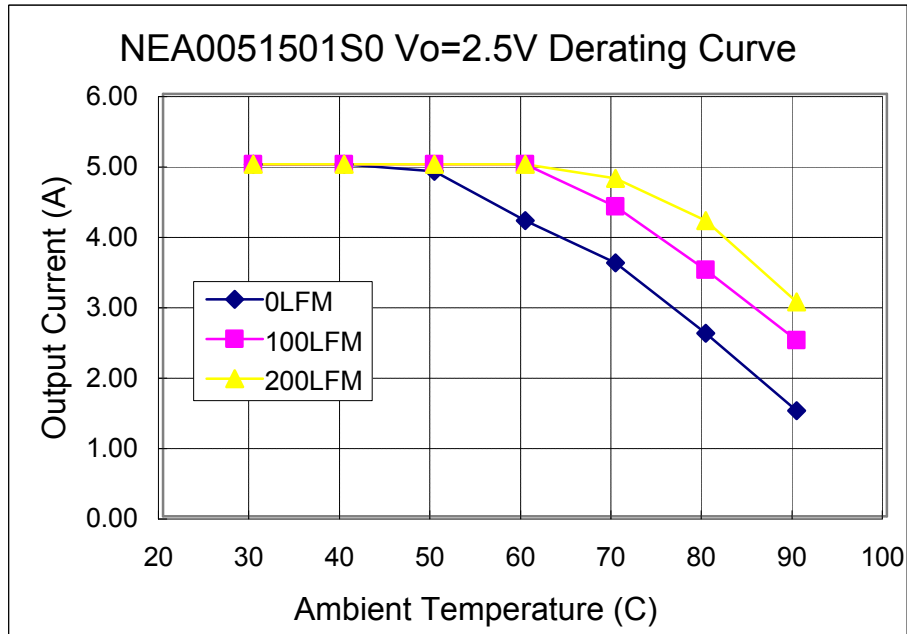

Fig 12. SMT Power Derating vs Output Current for 12Vin 2.5V Out.

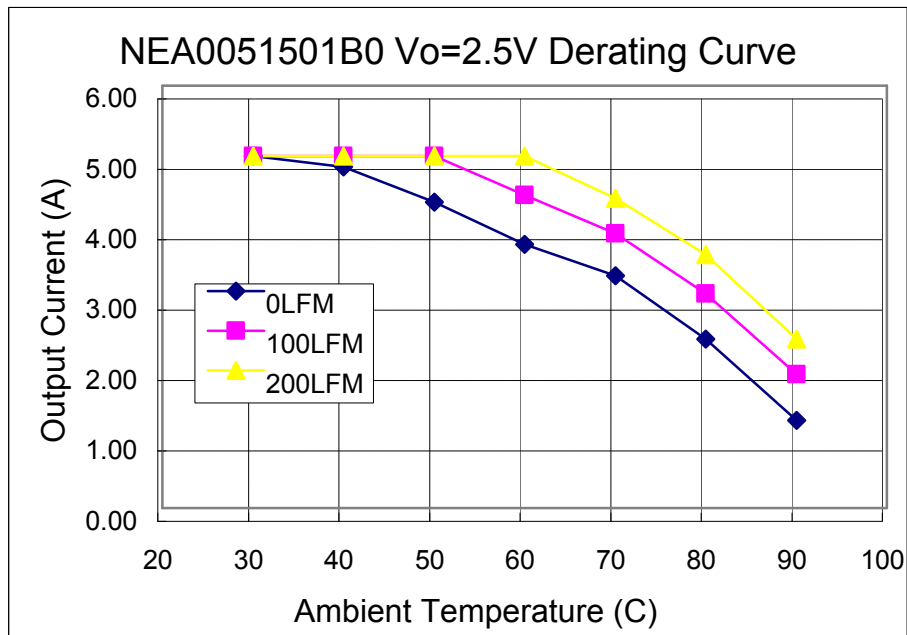

Fig 13. SIP Power Derating vs Output Current for 12Vin 2.5V Out.

Typical Derating Curves SIP/SMT Version

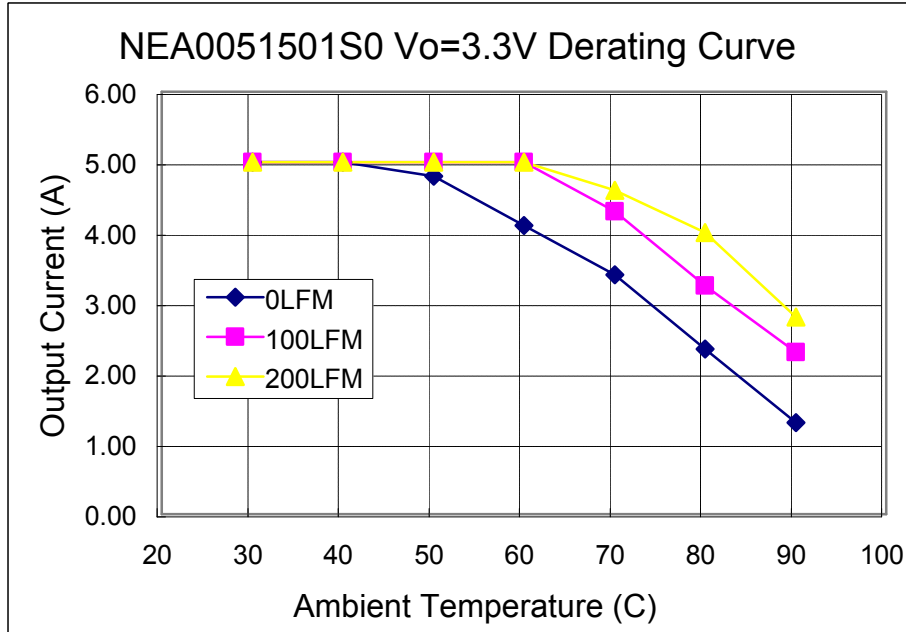

Fig. 14. SMT Power Derating vs Output Current for 12Vin 3.3V Out.

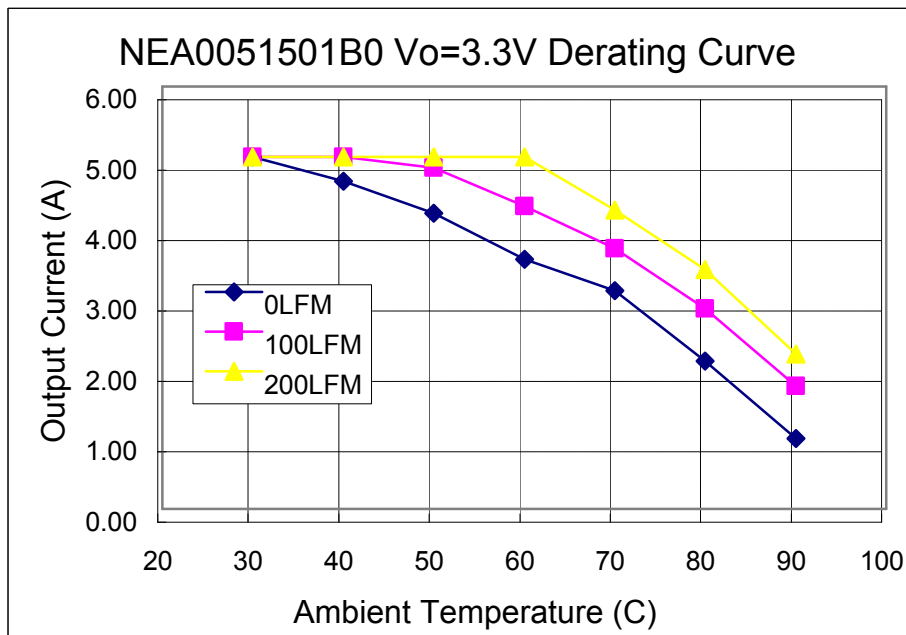

Fig. 15. SIP Power Derating vs Output Current for 12Vin 3.3V Out.

Typical Derating Curves SIP/SMT Version

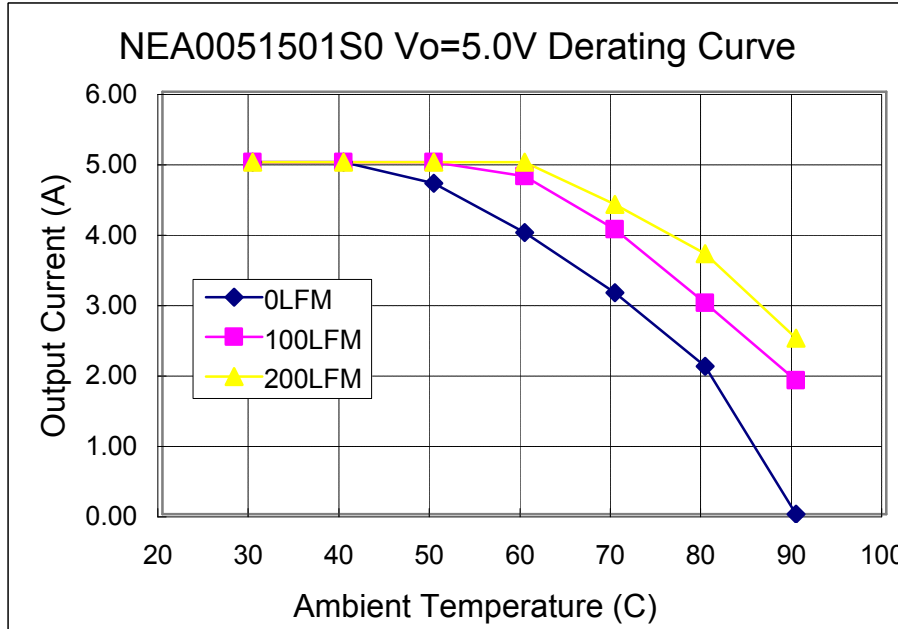

Fig. 16. SMT Power Derating vs Output Current for 12Vin 5.0V Out

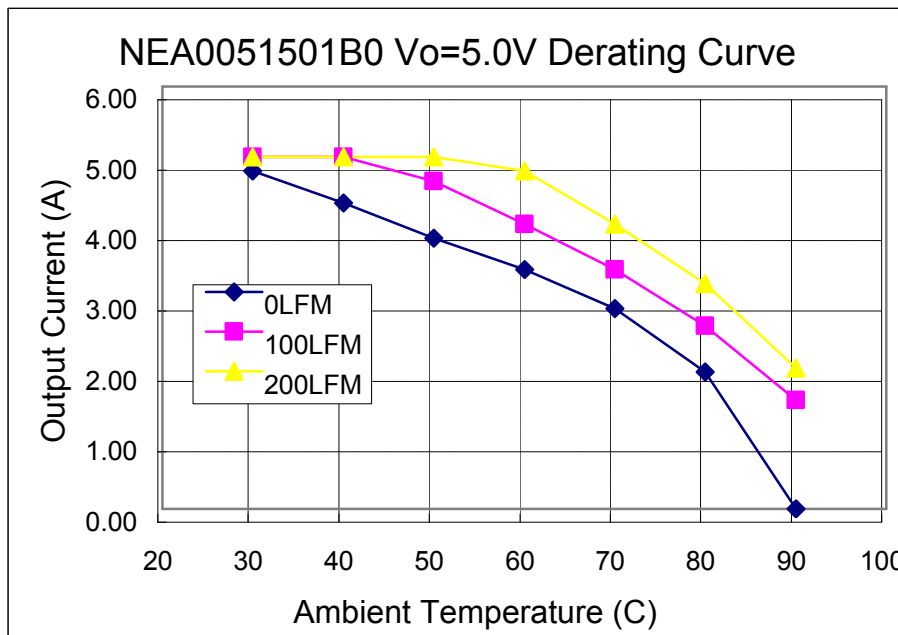

Fig. 17. SIP Power Derating vs Output Current for 12Vin 5.0V Out.

Typical Efficiency Curves for Various Voltage Models SIP/SMT Version

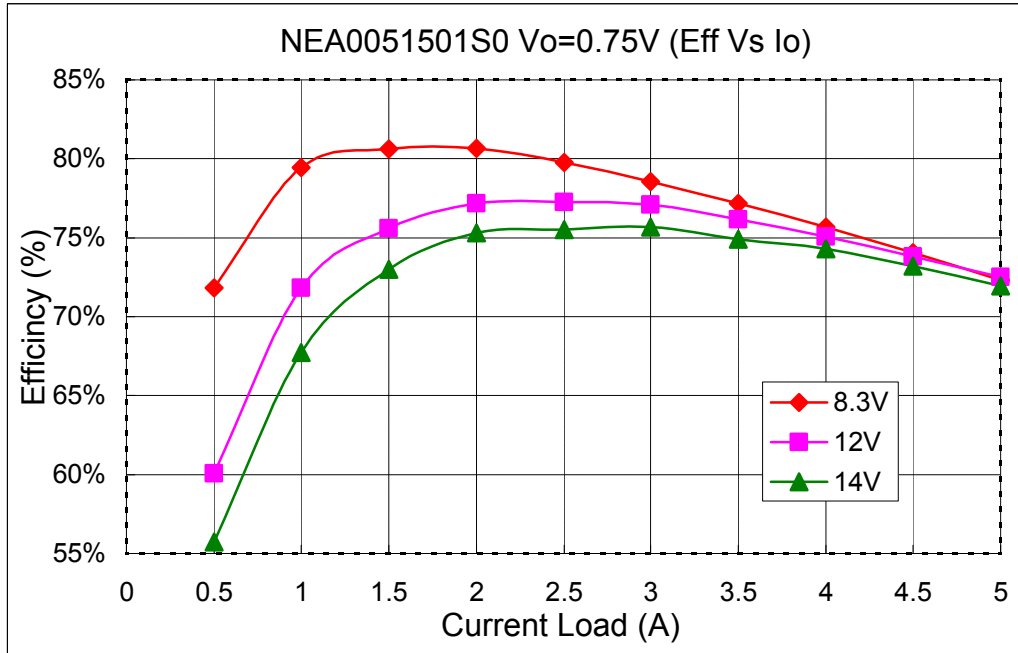

Fig 18. SMT Efficiency Curves for Vout=0.75V (25C)

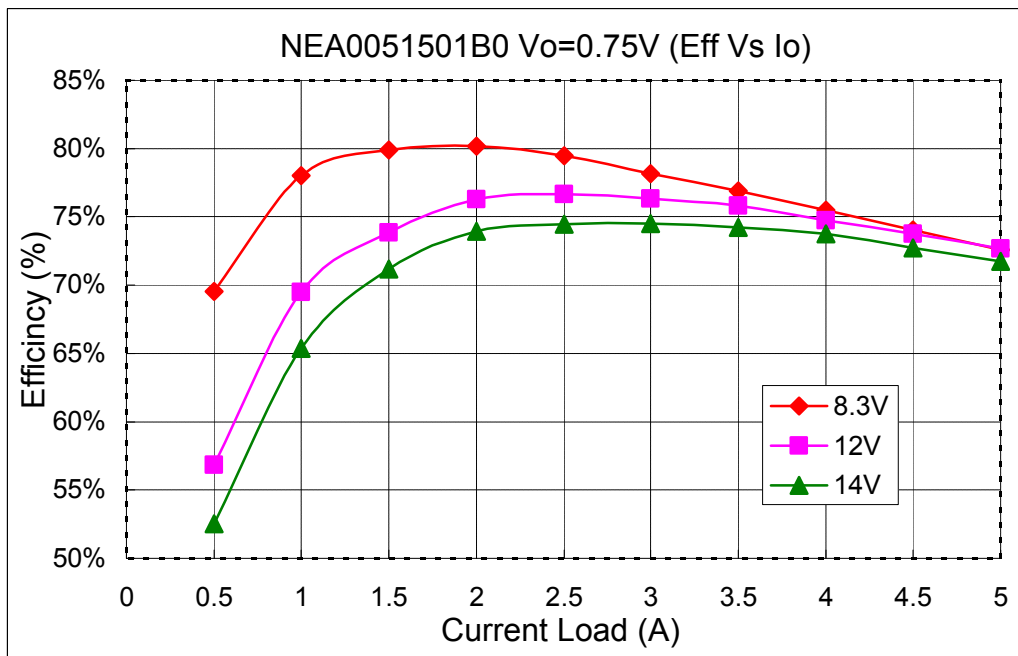

Fig 19. SIP Efficiency Curves for Vout=0.75V (25C)

Typical Efficiency Curves for Various Voltage Models SIP/SMT Version

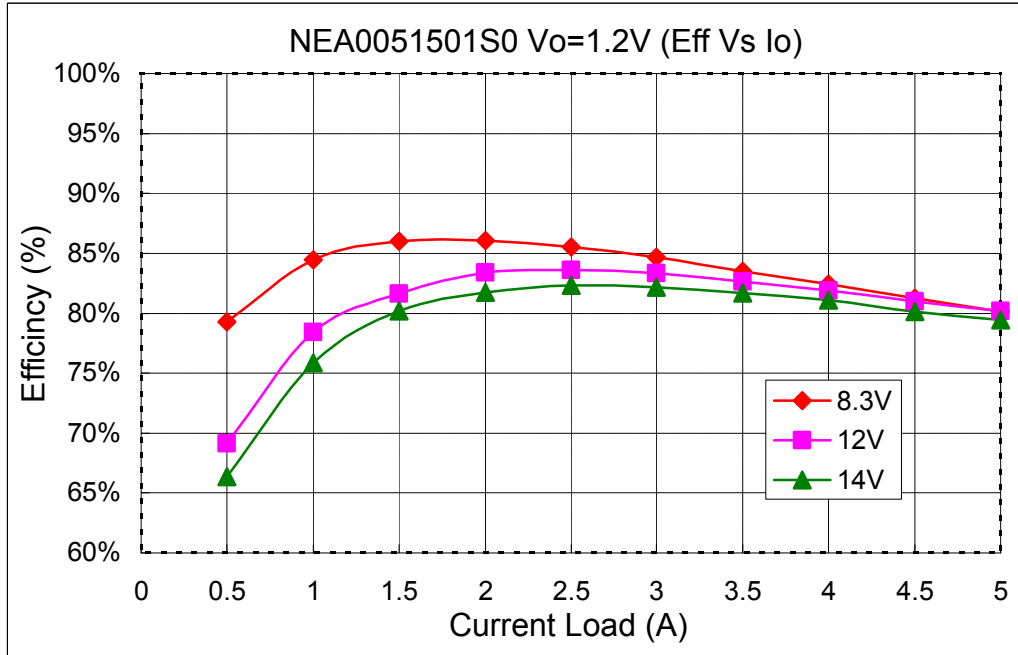

Fig 20. SMT Efficiency Curves for Vout=1.2V (25C)

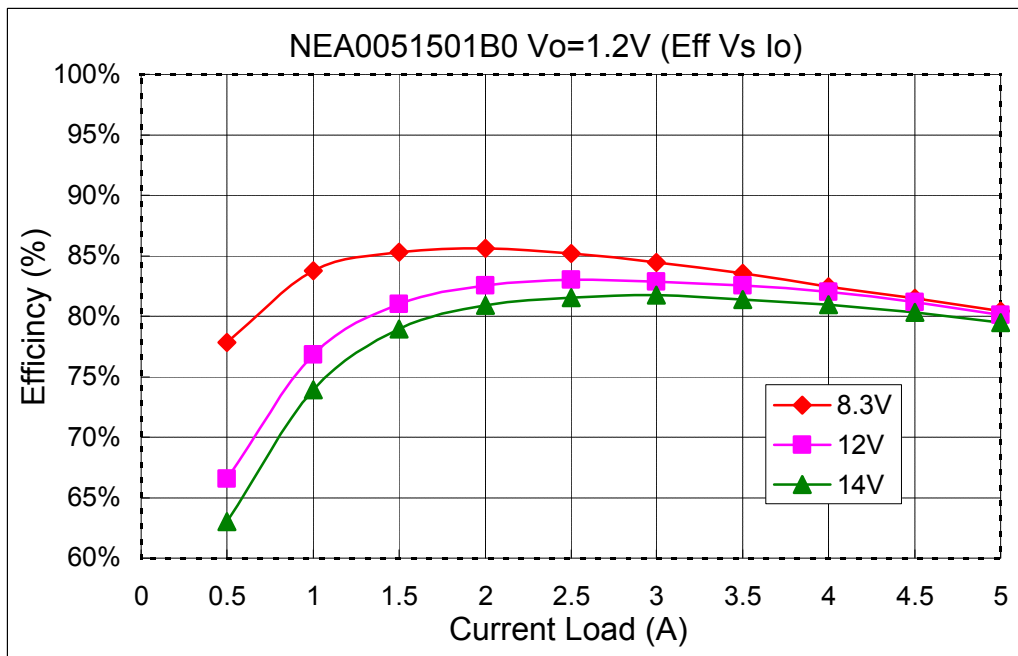

Fig 21. SIP Efficiency Curves for Vout=1.2V (25C)

Typical Efficiency Curves for Various Voltage Models SIP/SMT Version

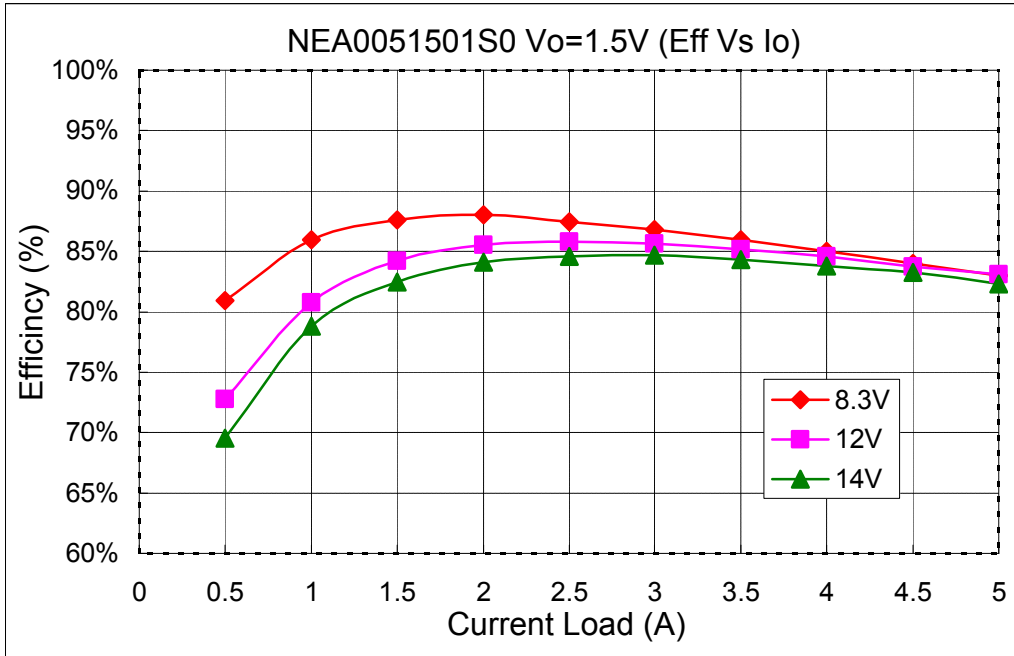

Fig 22. SMT Efficiency Curves for Vout=1.5V (25C)

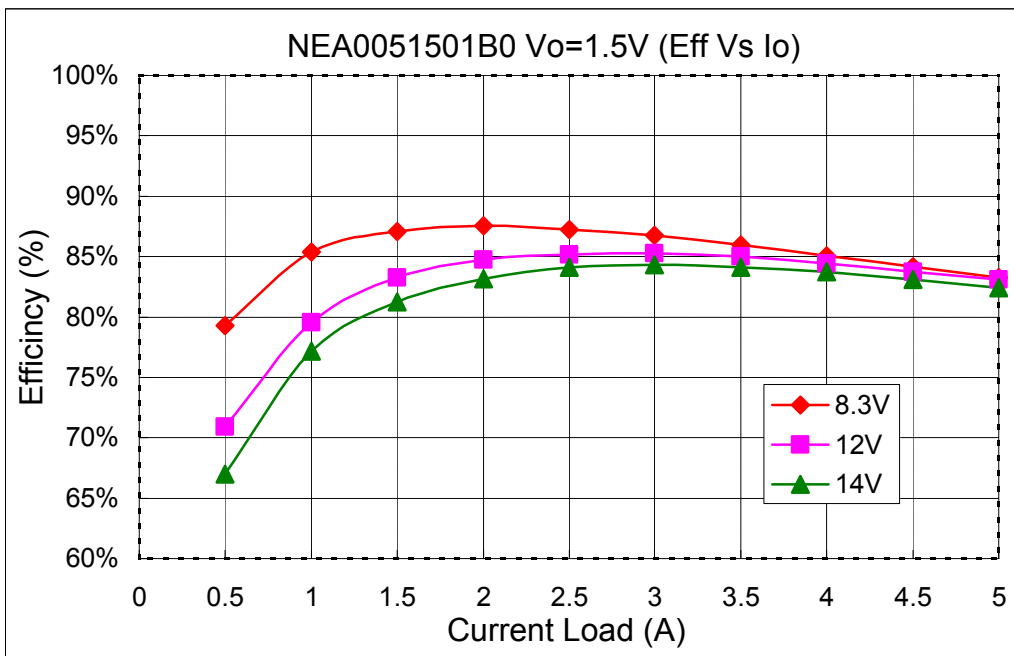

Fig 23. SIP Efficiency Curves for Vout=1.5V (25C)

Typical Efficiency Curves for Various Voltage Models SIP/SMT Version

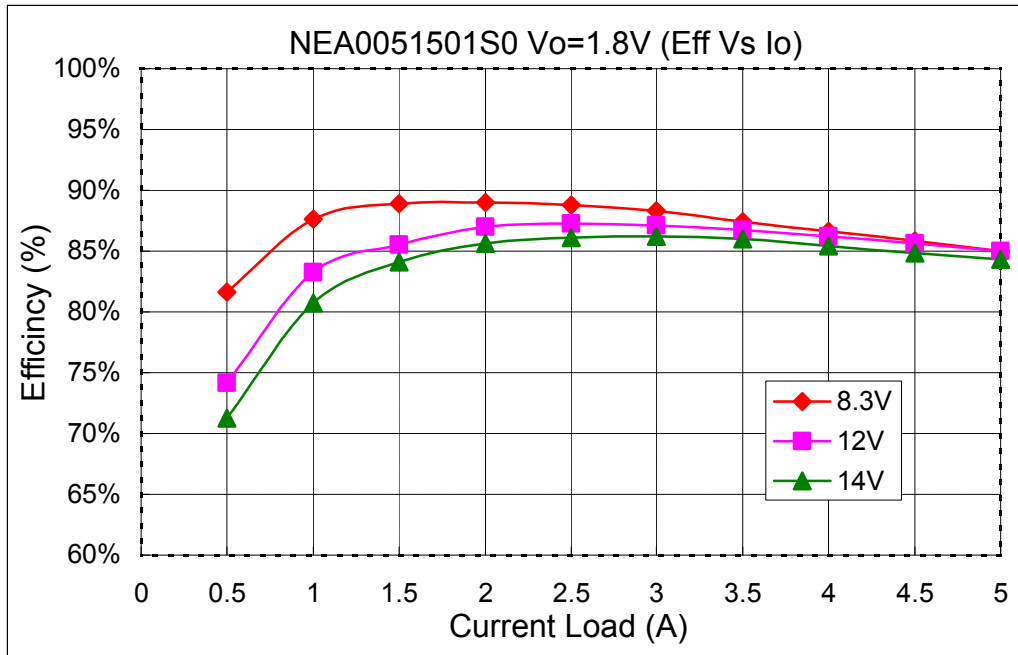

Fig 24. SMT Efficiency Curves for Vout=1.8V (25C)

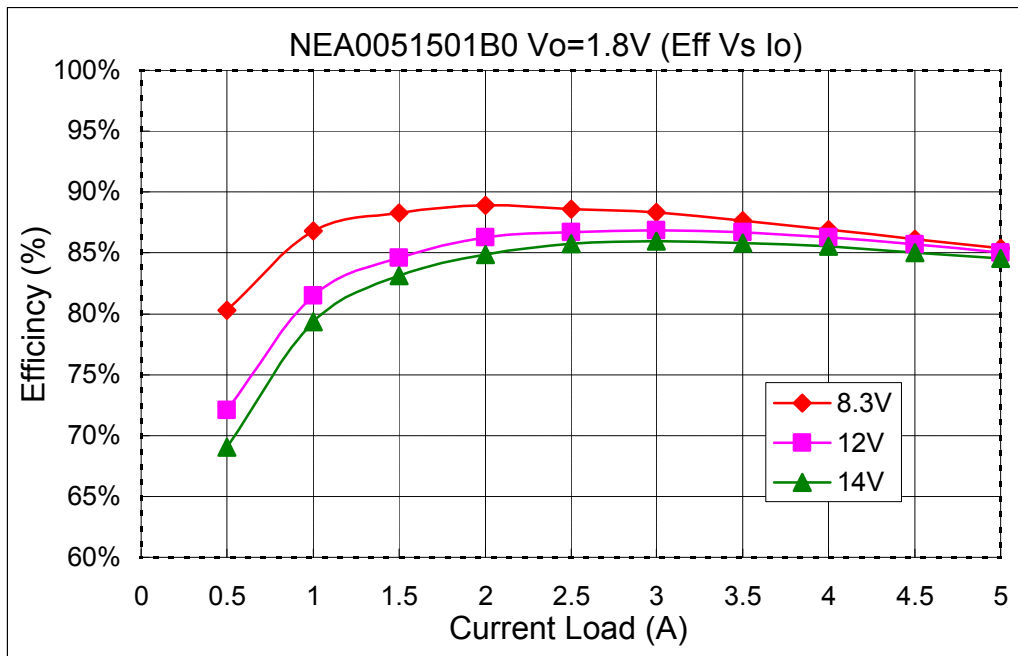

Fig 25. SIP Efficiency Curves for Vout=1.8V (25C)

Typical Efficiency Curves for Various Voltage Models SIP/SMT Version

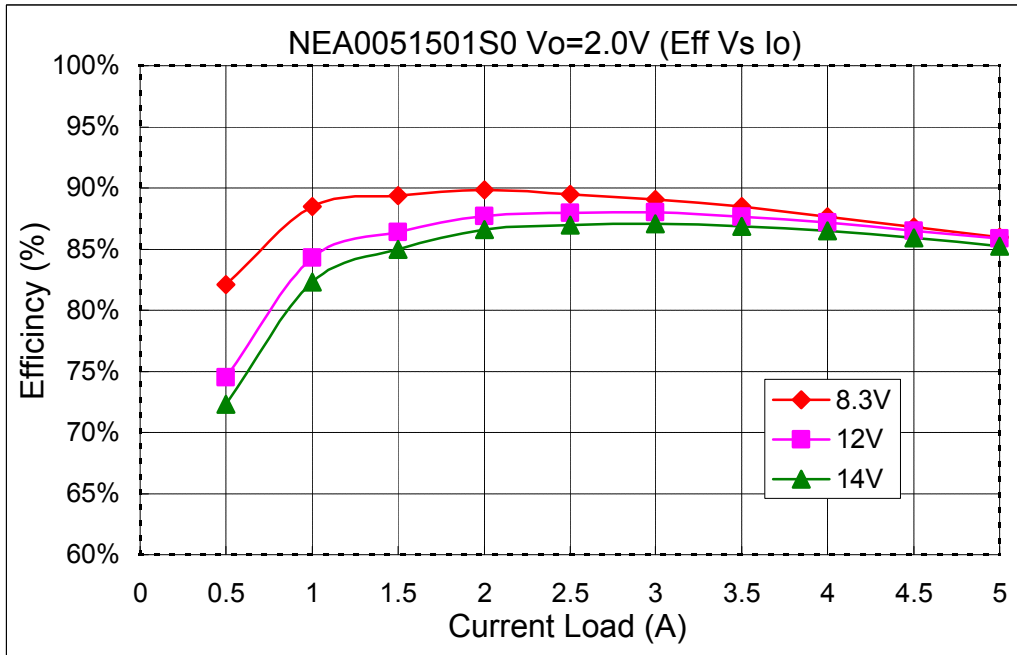

Fig 26. SMT Efficiency Curves for Vout=2.0V (25C)

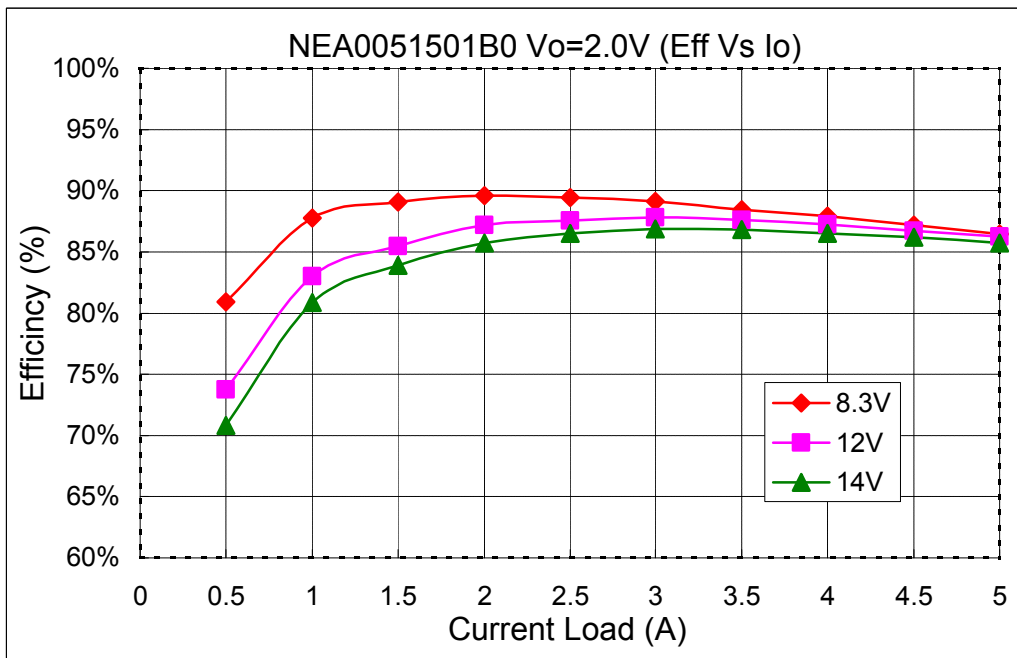

Fig 27. SIP Efficiency Curves for Vout=2.0V (25C)

Typical Efficiency Curves for Various Voltage Models SIP/SMT Version

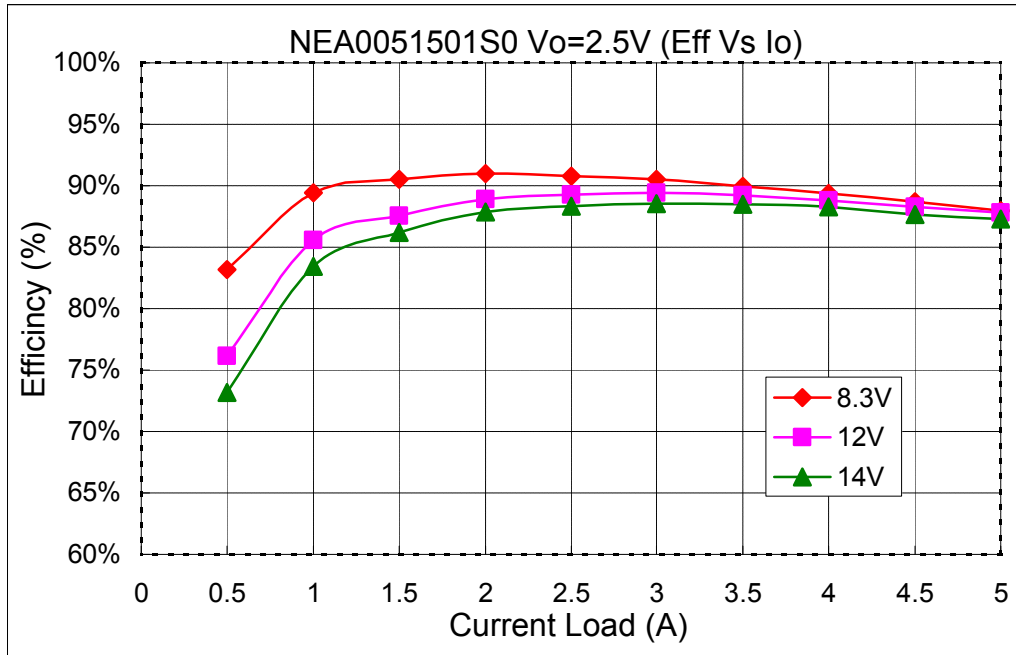

Fig 28. SMT Efficiency Curves for Vout=2.5V (25C)

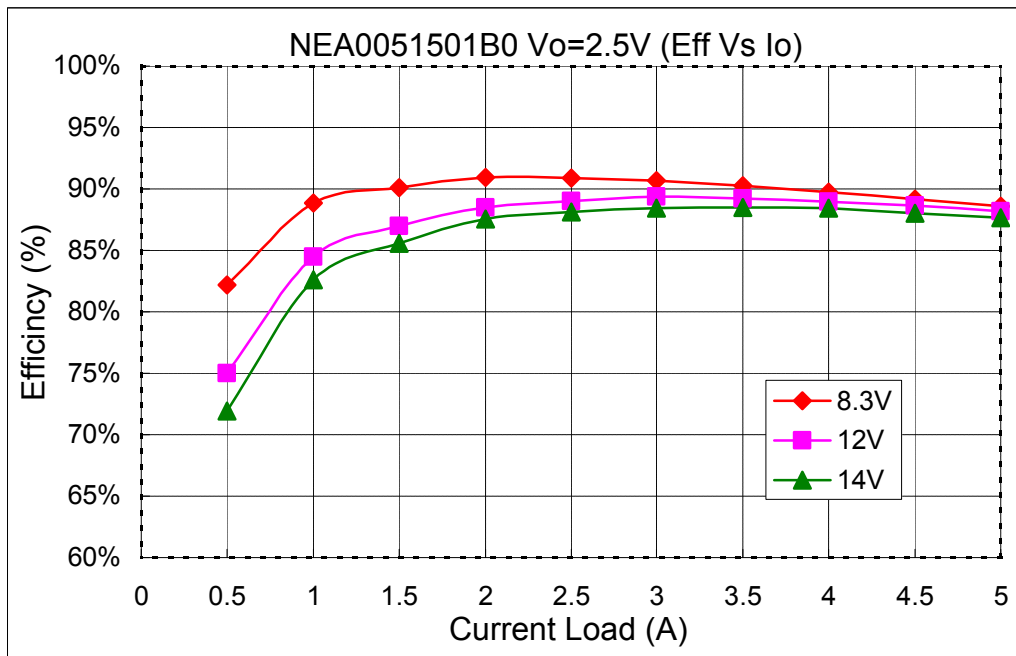

Fig 29. SIP Efficiency Curves for Vout=2.5V (25C)

Typical Efficiency Curves for Various Voltage Models SIP/SMT Version

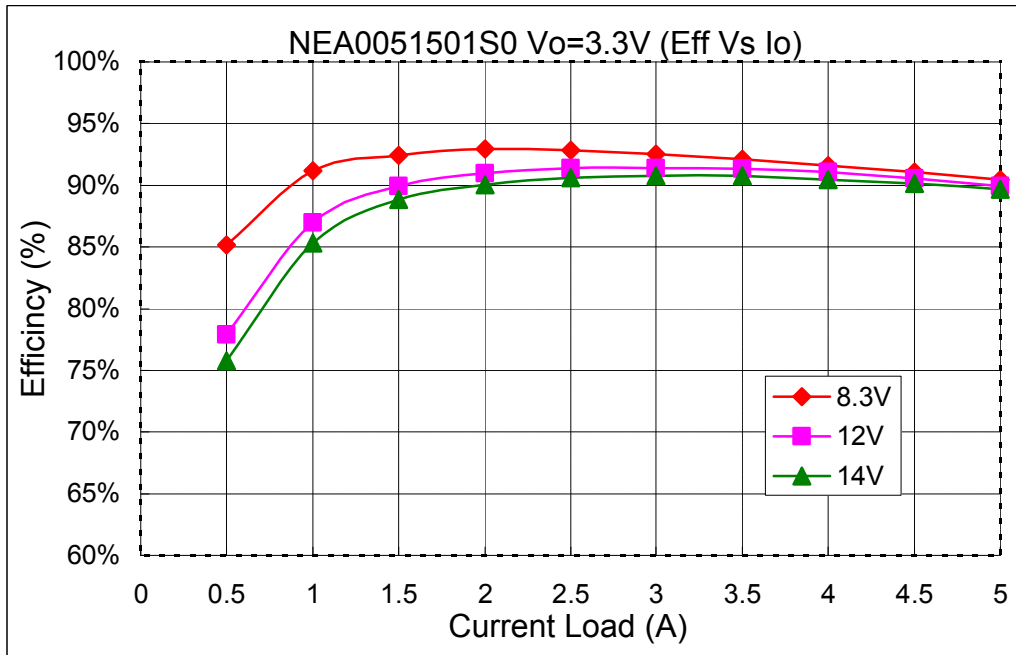

Fig 30. SMT Efficiency Curves for Vout=3.3V (25C)

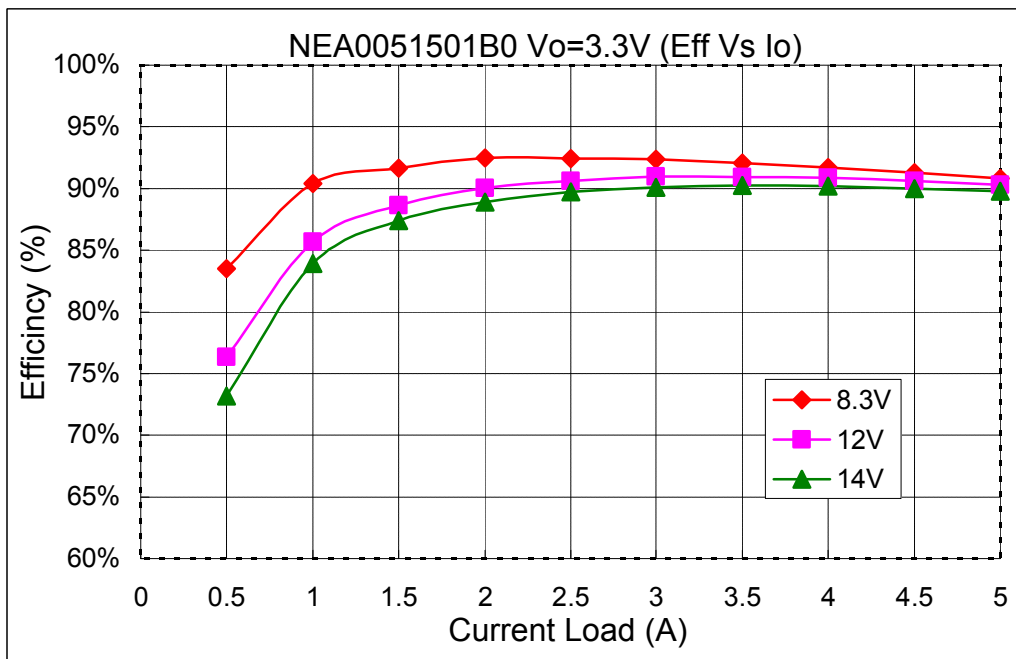

Fig 31. SIP Efficiency Curves for Vout=3.3V (25C)

Typical Efficiency Curves for Various Voltage Models SIP/SMT Version

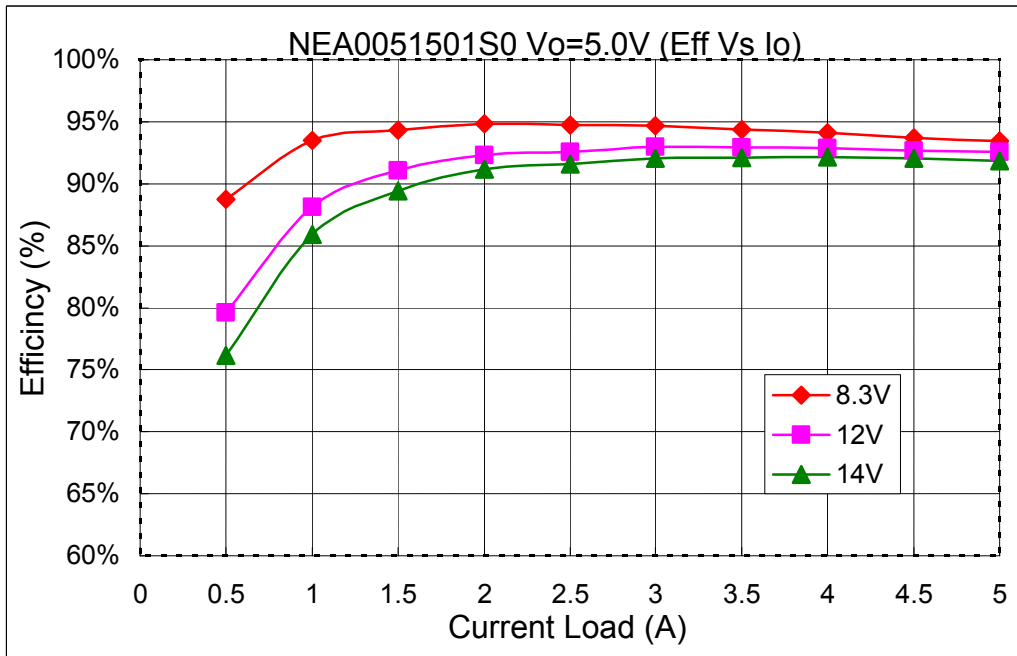

Fig 32. SMT Efficiency Curves for Vout=5.0V (25C)

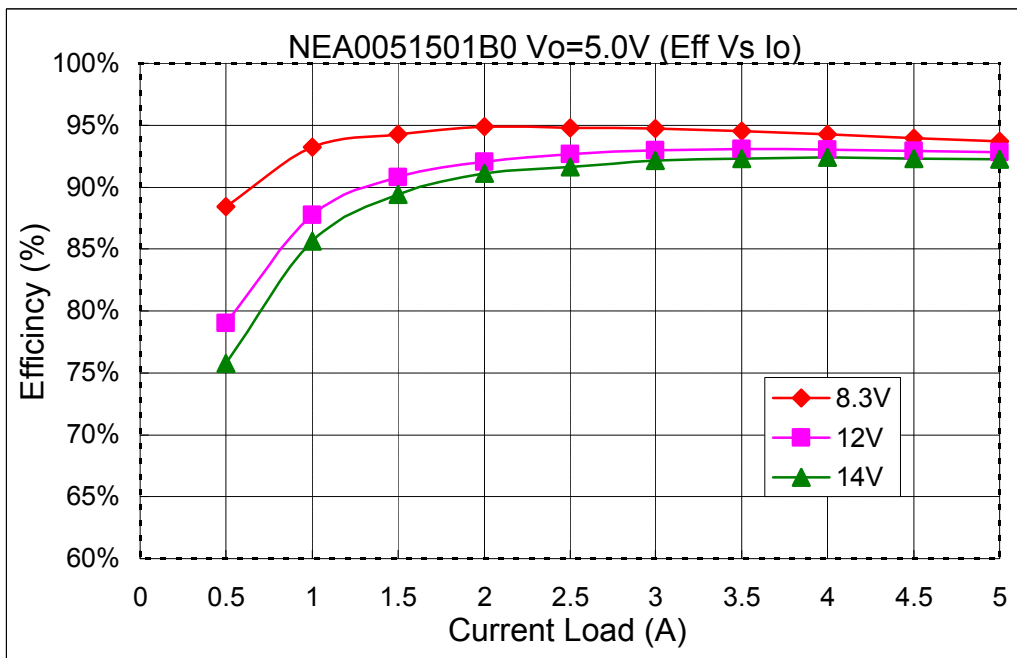
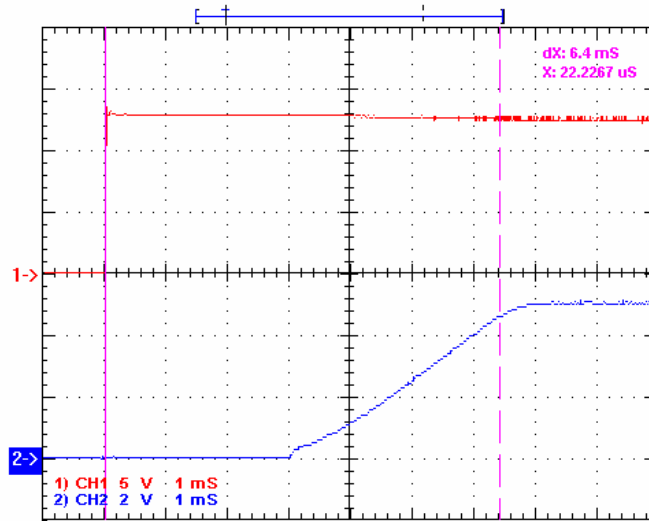

Fig 33. SIP Efficiency Curves for Vout=5.0V (25C)

Typical Start Up

Ch1 V_{IN}

Ch2 V_{OUT} , Full Load



Typical Start Up with Pre-bias

$V_{IN} = 12V_{dc}$

Ch1 V_{OUT}

Ch2 Output current at Full Load

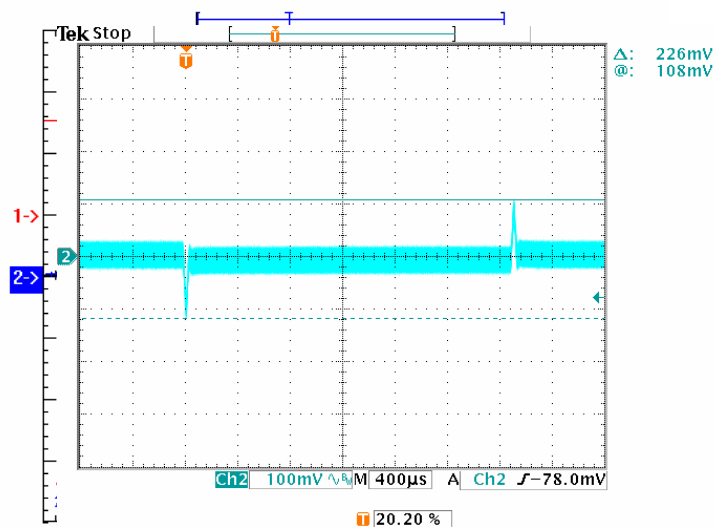

Typical Output Noise and Ripple

$V_{IN} = 12V_{dc}$, $V_o = 5.0V/5A$

Output with $1\mu F$ ceramic and $10\mu F$ tantulum capacitor

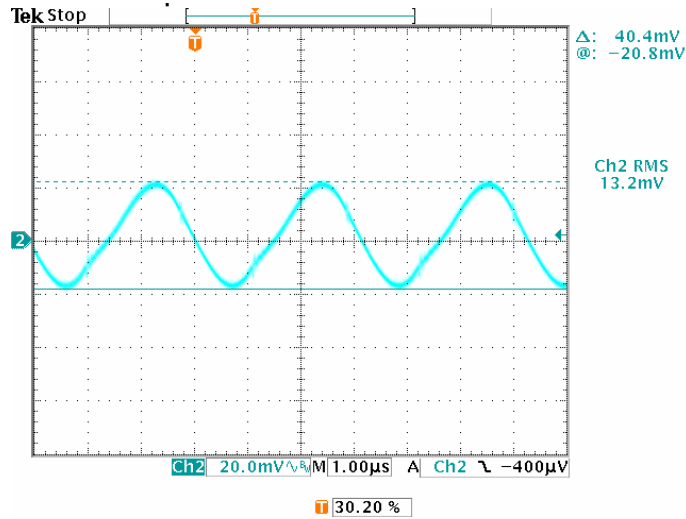

Typical Output Transient Response

$V_{IN} = 12V_{dc}$, $V_o = 5.0V$, 50% - 100% - 50% Load change @0.1 A/us.

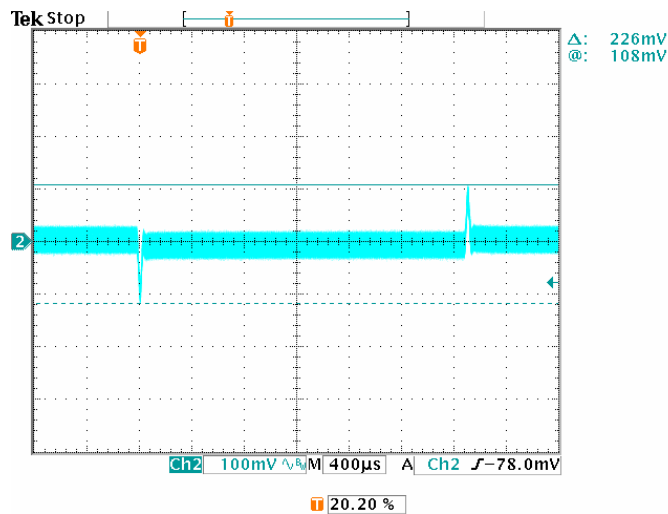

Output Voltage Set Point Adjustment

The following relationship establishes the calculation of external resistors:

$$R_{adj} = \frac{15 \times 0.7}{V_o - 0.7525} - 1 \text{ (k}\Omega\text{)}$$

For V_{OUT} setting an external resistor is connected between the TRIM and Ground Pin. Resistor values for different output voltages are calculated as given in the table:

Resistor Values	
V_o , set (Volts)	R_{adj} k Ω
0.75	Open
1.2	22.46
1.5	13.05
1.8	9.024
2.0	7.417
2.5	5.009
3.3	3.122
5.0	1.472

SMT Lead Free Reflow Profile

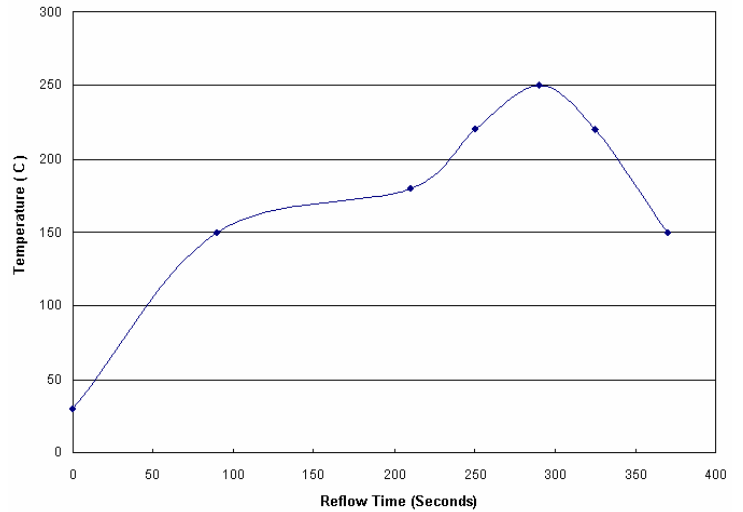

1. Ramp up rate during preheat: 1.33°C/Sec (from 30°C to 150°C)
2. Soaking temperature: 0.29°C/Sec (from 150°C to 180°C)
3. Ramp up rate during reflow: 0.8°C/Sec (from 220°C to 250°C)
4. Peak temperature: 250°C, above 220°C 40 to 70 Seconds
5. Ramp up rate during cooling: -1.56°C/Sec (from 220°C to 150°C)

Mechanical and Pinning Information

Given below is the outline drawing showing physical dimensions of the SIP & SMT package.

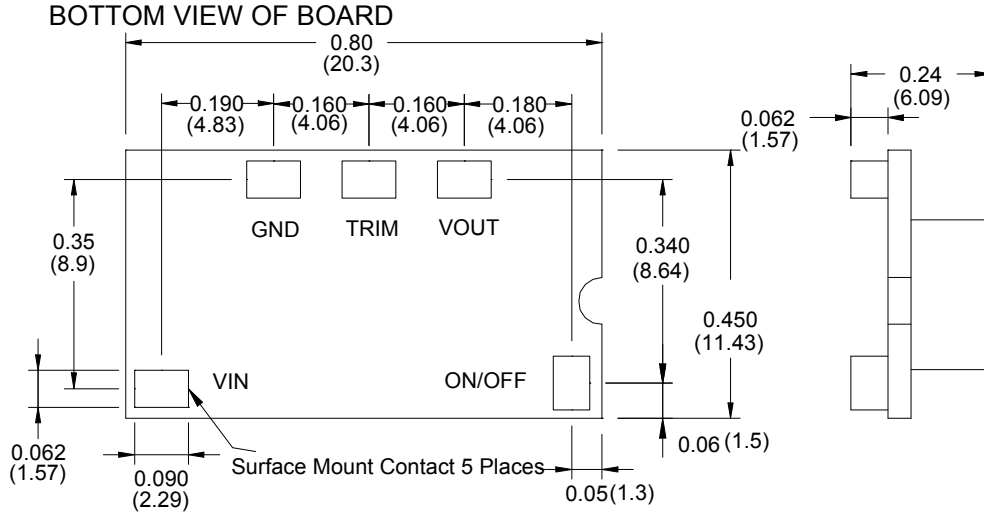

Dimensions are in Inches (millimeters)

Tolerances :x.xx = ±0.02in. (x.x = ±0.5mm) , unless otherwise noted
x.xxx = ±0.010in. (x.xx = ±0.25mm)

The external dimensions for SMT package are 0.8" x 0.45" x 0.24" (20.3mm x 11.43mm x 6.09mm).
Recommended Pad Layout

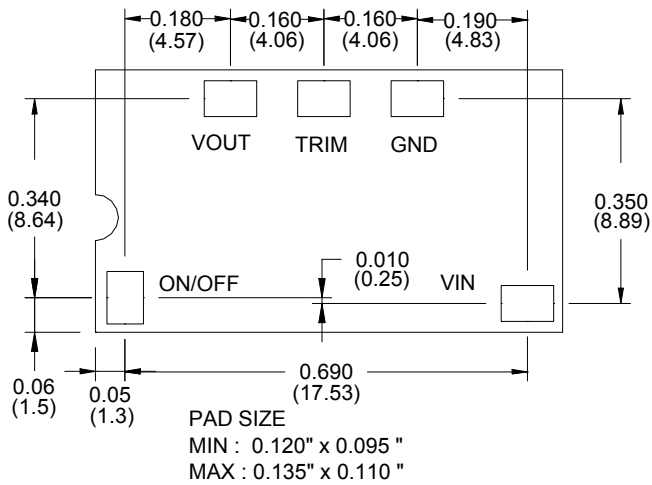

Whereas, the external dimensions of the SIP version are 0.9" x 0.4" x 0.22" (22.9mm x 10.16mm x 5.6mm).

Size SIP05

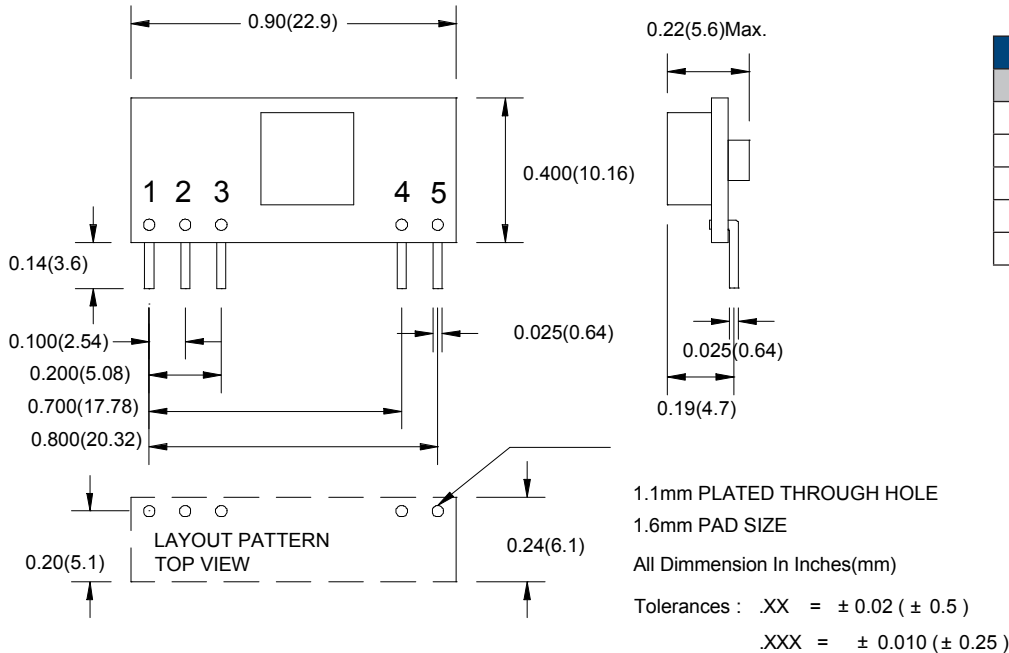

Pin Connection	
Pin	Function
1	+Output
2	Trim
3	Common
4	+V Input
5	On/Off

Safety Considerations

The NEA series of converters are certified to IEC/EN/CSA/UL 60950. If this product is built into information technology equipment, the installation must comply with the above standard. An external input fuse of no more than 20 A must be used to meet the above requirements. The output of the converter [Vo(+)/Vo(-)] is considered to remain within SELV limits when the input to the converter meets SELV or TNV-2 requirements. The converters and materials meet UL 94V-0 flammability rating

Ordering Information					
Part Number	V _{IN}	V _{OUT}	I _{OUT}	Enable Logic	Pin Length
NEA0051500B0C	8.3V – 14.0V	0.75V – 5.0V	5A	Negative	0.139"
NEA0051500S0C	8.3V – 14.0V	0.75V – 5.0V	5A	Negative	SMT
NEA0051501B0C	8.3V – 14.0V	0.75V – 5.0V	5A	Positive	0.139"
NEA0051501S0C	8.3V – 14.0V	0.75V – 5.0V	5A	Positive	SMT

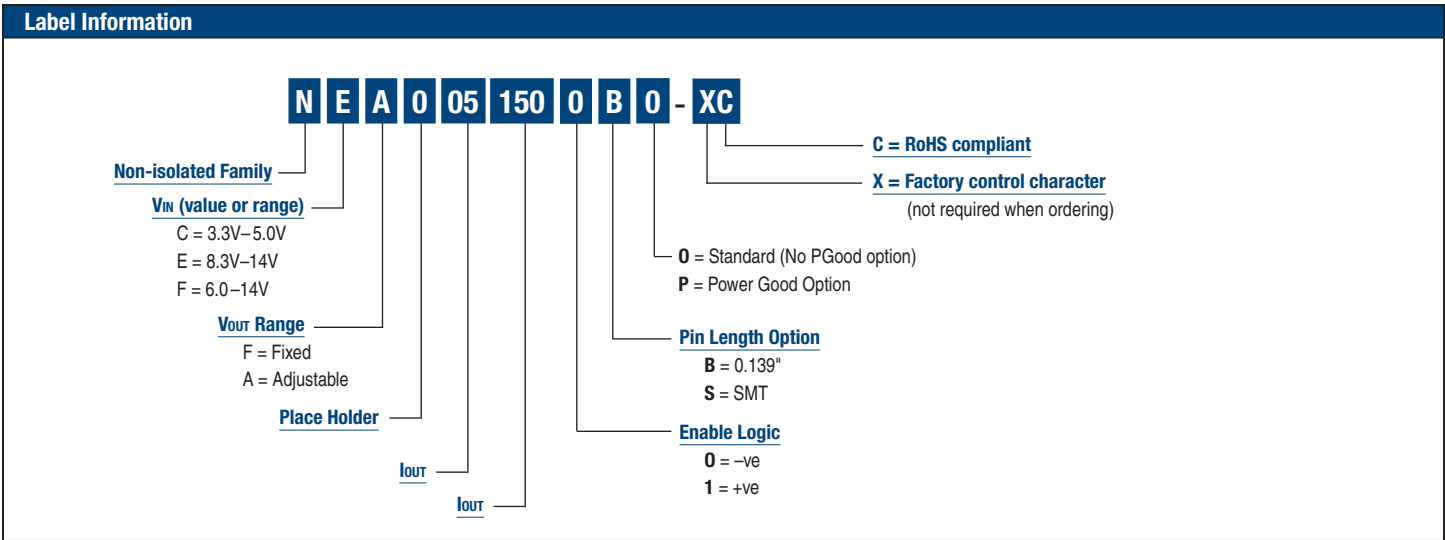

RoHS Compliant

The NEA005 series of converters is in compliance with the European Union Directive 2002/95/EC (RoHS) with respect to the following substances: lead (Pb), mercury (Hg), cadmium (Cd), hexavalent chromium, polybrominated biphenyls (PBB) or polybrominated diphenyl ethers (PBDE).