

GOG9xx04C

THREE PHASE AC-DC BRIDGE

- Fuse protection
- Blown fuse indicators with microswitch
- Over temperature switches
- Fan loss detection circuit
- Snubber for SCR's protections
- Compact design

LINE VOLTAGE UP TO 500V
DC OUTPUT CURRENT 400A

GOG94004C GOG95004C

Line to line voltage	400	500
----------------------	------------	------------

Characteristic		Conditions	Value	Value	
I _{DC}	DC output current		400 A	400 A	
V _{INS} (rms)	Insulation voltage		3000 V	3000 V	

THYRISTOR TRIGGERING CHARACTERISTICS

V _{GT}	Gate trigger voltage	T _j = 25 °C, V _D = 5 V	3 V	3 V	
I _{GT}	Gate trigger current	T _j = 25 °C, V _D = 5 V	300 mA	300 mA	
dV/dt	Critical rate of rise off-state voltage	T _j = 125 °C	1000 V/us	1000 V/us	
V _{RRM}	Blocking Voltage	T _j = 125 °C	1200 V	1600 V	

FUSE TYPE SIBA 2062432.450

V _{NF}	Rated voltage		690 V	690 V	
I _{NF}	Rated current		450 A	450 A	
P _{VF}	Power loss	At rated current	75 W	75 W	
I ² t	Total I ² t	At 660V	110 kA2s	110 kA2s	

MECHANICAL AND THERMAL CHARACTERISTICS

	Width		400 mm	450 mm	
	Depth		340 mm	340,5 mm	
	Height		500 mm	500 mm	
	Mass		30 Kg	30 Kg	
T _a max	Max amb. op. Temp.		40 °C	40 °C	
T _{stg}	Storage temperature		-40/ +60 °C	-40/ +60 °C	

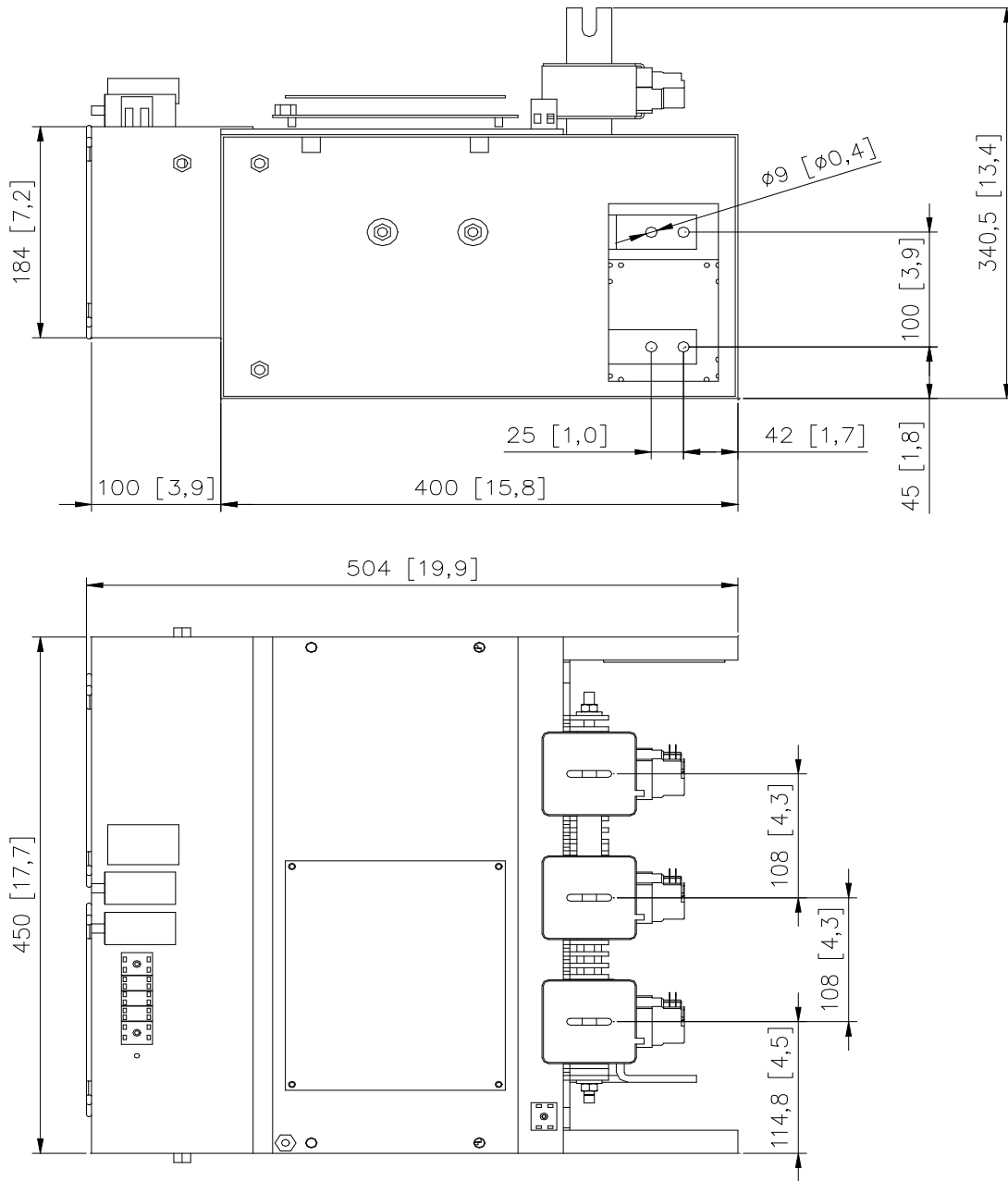

The part numbering system is reported at the beginning of the Open Assembly section.

Customisations are available on request. Please contact factory.

In the interest of product improvement Green Power Solutions reserves the right to change any specification given in this data sheet without notice.

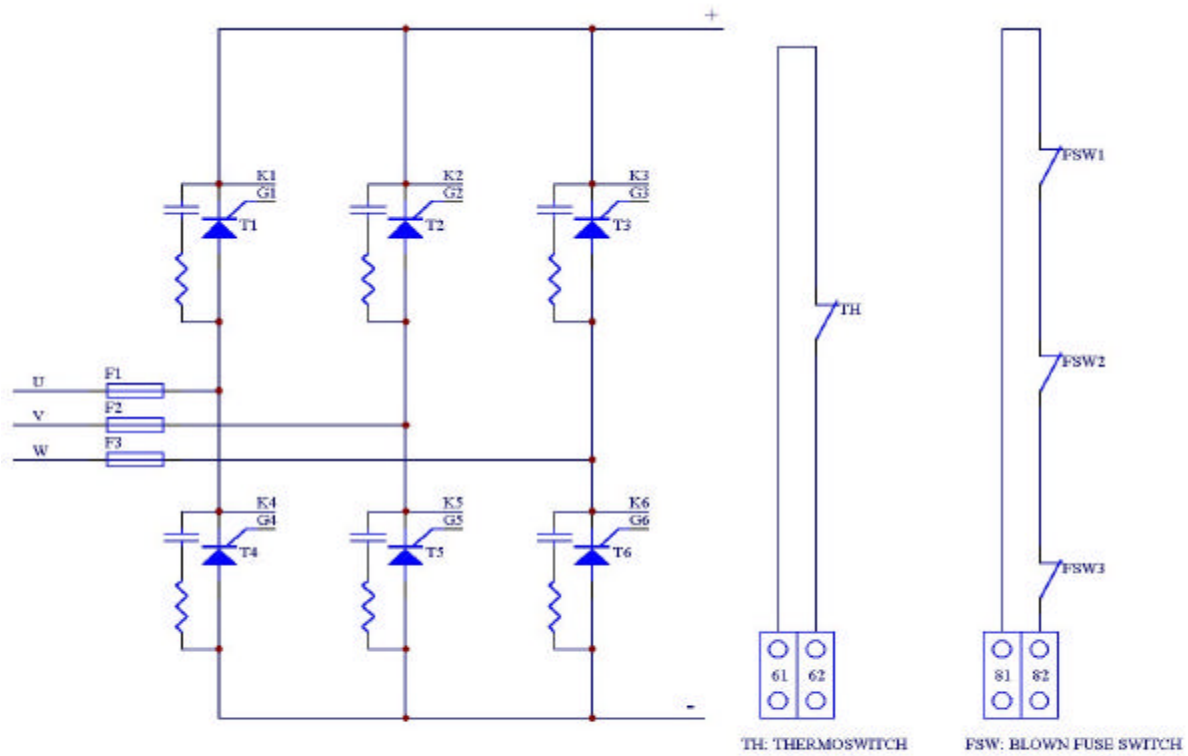

61-62: THERMOSWITCH CIRCUIT CONNECTION
81-82: BLOWN FUSE SWITCH CIRCUIT CONNECTION

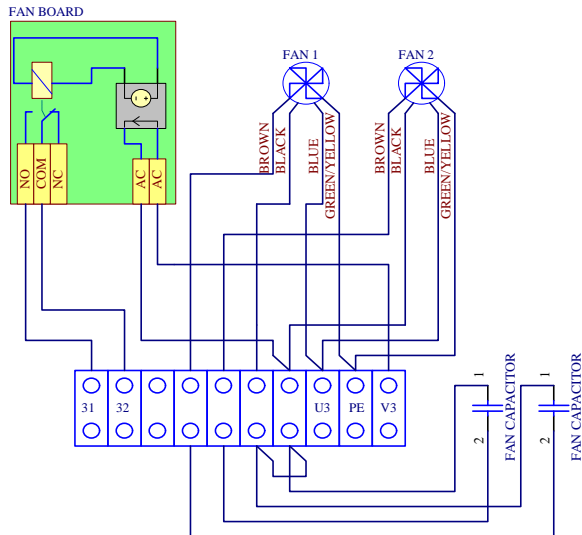

U3-V3: MAIN SUPPLY
PE: GROUND CONNECTION (GND)
31-32: FAN BOARD CONTACT (CLOSED WHEN FAN RUNNING)

Cooling:

- Fan type: single phase axial
- Number of fans: 2
- Voltage: 230 V
- Current: 0.4 A
- Frequency: 50/60 Hz
- Noise: 62 dBA

In the interest of product improvement Green Power Solutions reserves the right to change any specification given in this data sheet without notice.