

RoHS Compliant Product

Description

The SSG9960 provide the designer with the best combination of fast switching, ruggedized device design, Ultra low on-resistance and cost-effectiveness.

Features

- * Low on-resistance
- * Fast switching speed

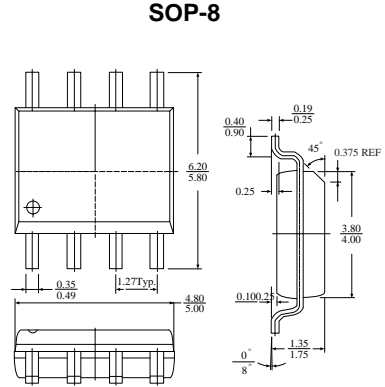
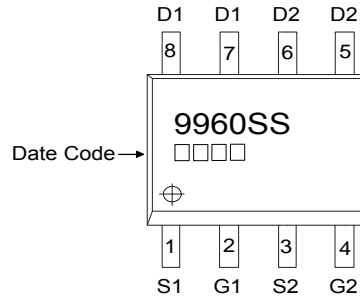

Dimensions in millimeters

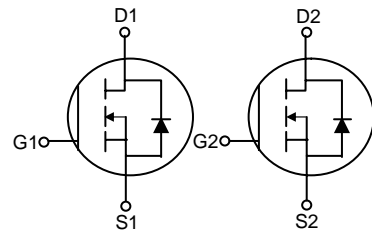

Absolute Maximum Ratings

Parameter	Symbol	Ratings	Unit
Drain-Source Voltage	V _{DS}	40	V
Gate-Source Voltage	V _{GS}	±20	V
Continuous Drain Current ³	I _D @T _A =25 °C	7.8	A
Continuous Drain Current ³	I _D @T _A =70 °C	6.2	A
Pulsed Drain Current ¹	I _{DM}	20	A
Total Power Dissipation	P _D @T _A =25 °C	2	W
Linear Derating Factor		0.016	W/°C
Operating Junction and Storage Temperature Range	T _J , T _{stg}	-55~+150	°C

Thermal Data

Parameter	Symbol	Ratings	Unit
Thermal Resistance Junction-ambient ³	R _{thj-a}	62.5	°C/W

Electrical Characteristics(T_j=25°C Unless otherwise specified)

Parameter	Symbol	Min.	Typ.	Max.	Unit	Test Condition
Drain-Source Breakdown Voltage	BV _{DSS}	40	-	-	V	V _{GS} =0V, I _D =250uA
Breakdown Voltage Temp. Coefficient	ΔBV _{DSS} /ΔT _j	-	0.032	-	V/°C	Reference to 25 °C, I _D =1mA
Gate Threshold Voltage	V _{GS(th)}	1.0	-	3.0	V	V _{DS} =V _{GS} , I _D =250uA
Gate-Source Leakage Current	I _{GSS}	-	-	±100	nA	V _{GS} =±20V
Drain-Source Leakage Current (T _j =25°C)	I _{DSS}	-	-	1	uA	V _{DS} =40V, V _{GS} =0
Drain-Source Leakage Current (T _j =70°C)		-	-	25	uA	V _{DS} =32V, V _{GS} =0
Static Drain-Source On-Resistance ²	R _{DS(ON)}	-	-	20	mΩ	V _{GS} =10V, I _D =7A
		-	-	32		V _{GS} =4.5V, I _D =5A
Total Gate Charge ²	Q _g	-	14.7	-	nC	I _D =7A V _{DS} =20V V _{GS} =4.5V
Gate-Source Charge	Q _{gs}	-	7.1	-		
Gate-Drain ("Miller") Charge	Q _{gd}	-	6.8	-		
Turn-on Delay Time ²	T _{d(ON)}	-	11.5	-	nS	V _{DS} =20V I _D =1A V _{GS} =10V R _G =3.3Ω R _D =20Ω
Rise Time	T _r	-	6.3	-		
Turn-off Delay Time	T _{d(OFF)}	-	28.2	-		
Fall Time	T _f	-	12.6	-		
Input Capacitance	C _{iss}	-	1725	-	pF	V _{GS} =0V V _{DS} =25V f=1.0MHz
Output Capacitance	C _{oss}	-	235	-		
Reverse Transfer Capacitance	C _{rss}	-	145	-		
Forward Transconductance	G _{fs}	-	25	-	S	V _{DS} =10V, I _D =7A

Source-Drain Diode

Parameter	Symbol	Min.	Typ.	Max.	Unit	Test Condition
Forward On Voltage ²	V _{SD}	-	-	1.3	V	I _S =2.3A, V _{GS} =0V.
Continuous Source Current (Body Diode)	I _S	-	-	2.3	A	V _D =V _G =0V, V _S =1.3V
Pulsed Source Current (Body Diode)	I _{SM}	-	-	20	A	

- Notes: 1.Pulse width limited by Max. junction temperature.
2.Pulse width ≤ 300us, dutycycle ≤ 2%.
3.Surface mounted on 1 inch² copper pad of FR4 board; t ≤ 10sec.

Characteristics Curve

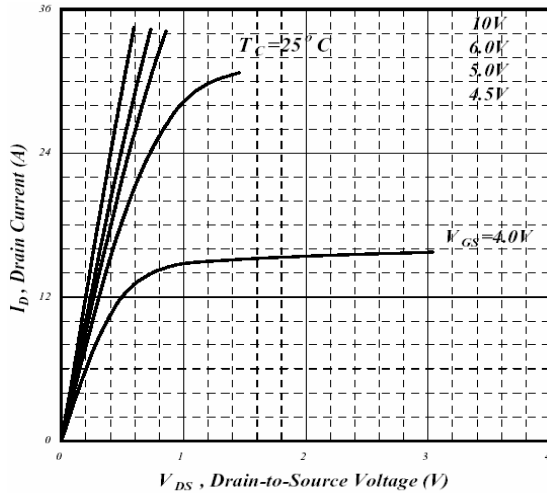

Fig 1. Typical Output Characteristics

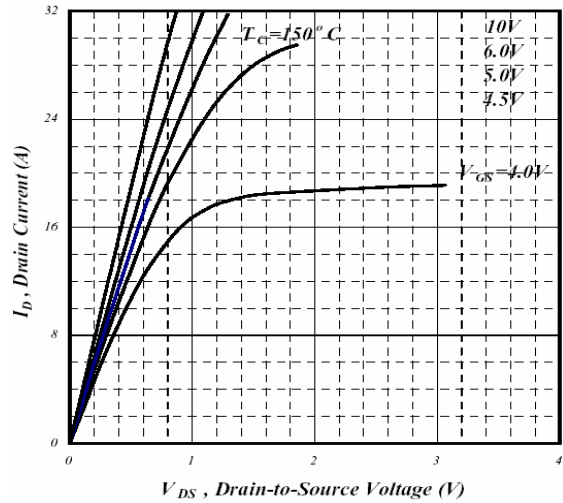

Fig 2. Typical Output Characteristics

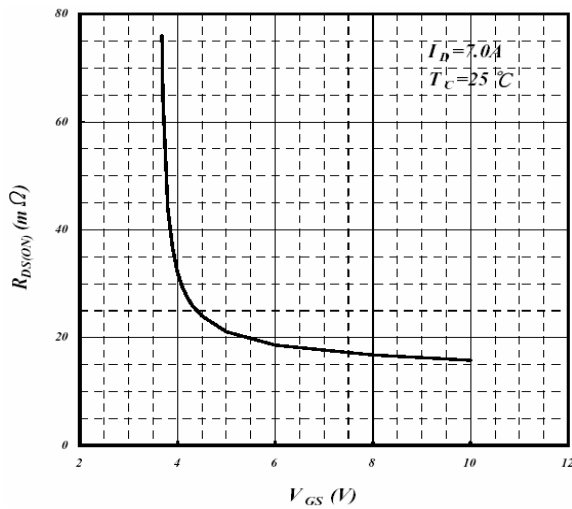

Fig 3. On-Resistance v.s. Gate Voltage

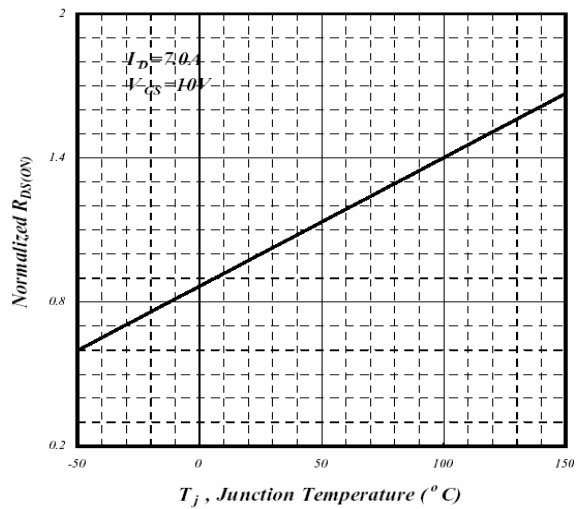

Fig 4. Normalized On-Resistance v.s. Junction Temperature

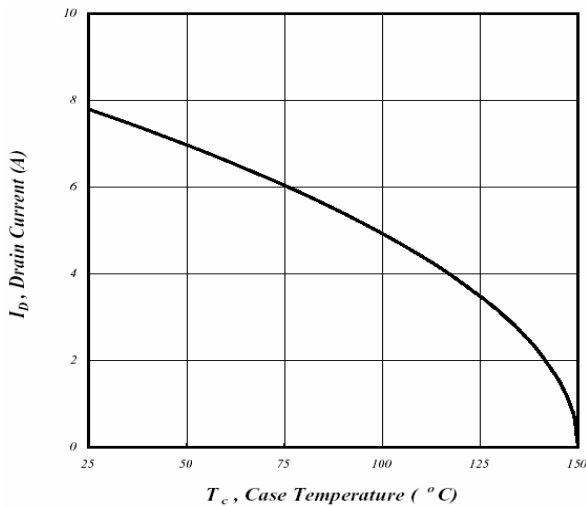

Fig 5. Maximum Drain Current v.s. Case Temperature

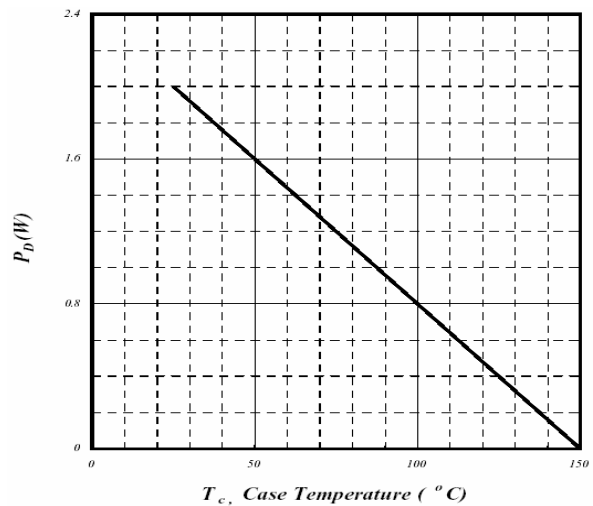

Fig 6. Type Power Dissipation

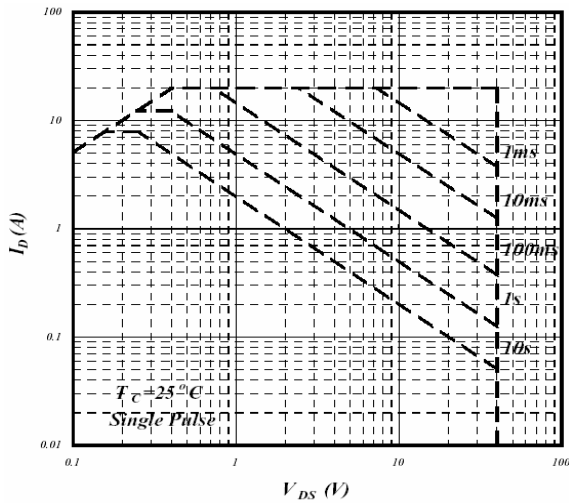

Fig 7. Maximum Safe Operating Area

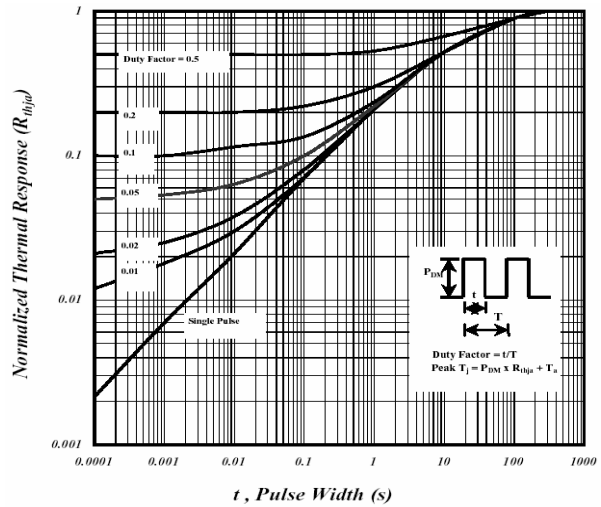

Fig 8. Effective Transient Thermal Impedance

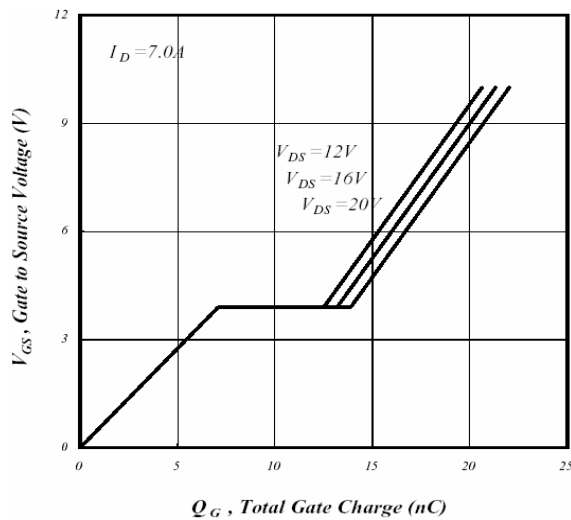

Fig 9. Gate Charge Characteristics

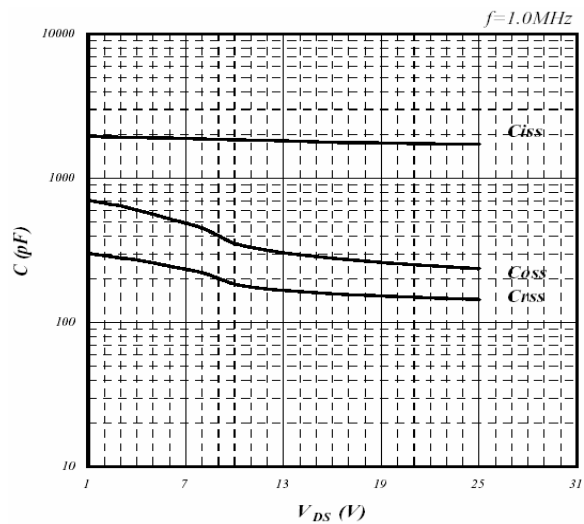

Fig 10. Typical Capacitance Characteristics

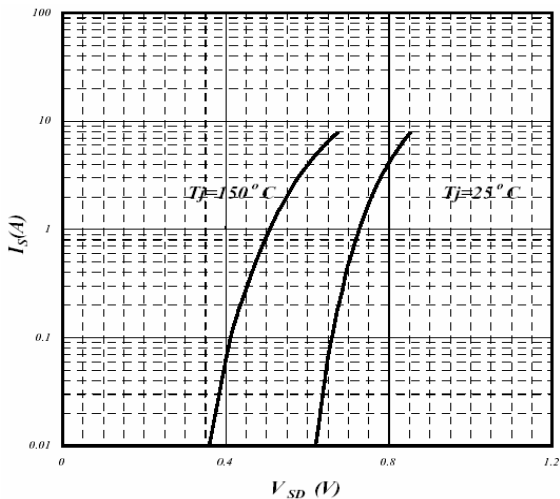

Fig 11. Forward Characteristics of Reverse Diode

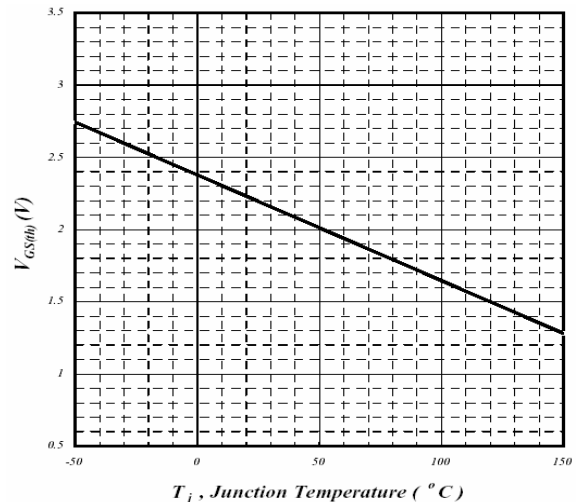

Fig 12. Gate Threshold Voltage v.s. Junction Temperature

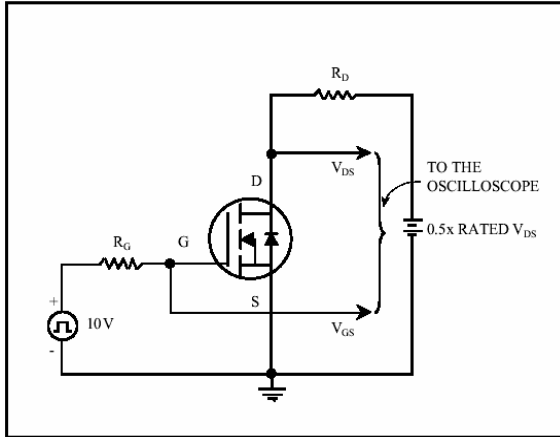

Fig 13. Switching Time Circuit

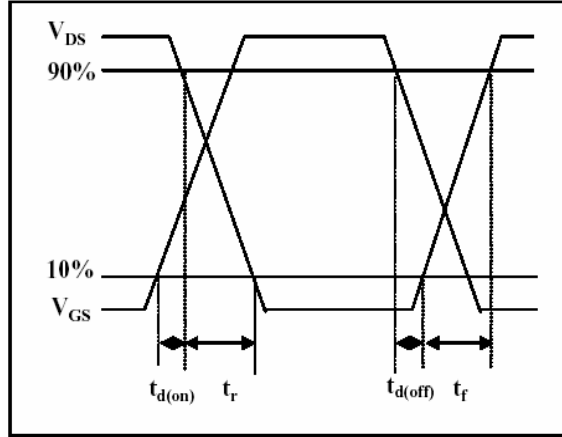

Fig 14. Switching Time Waveform

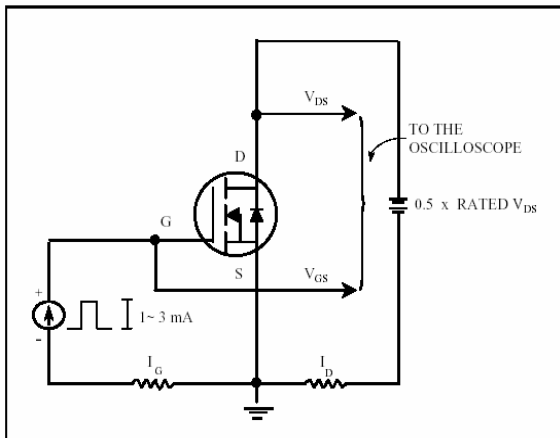

Fig 15. Gate Charge Circuit

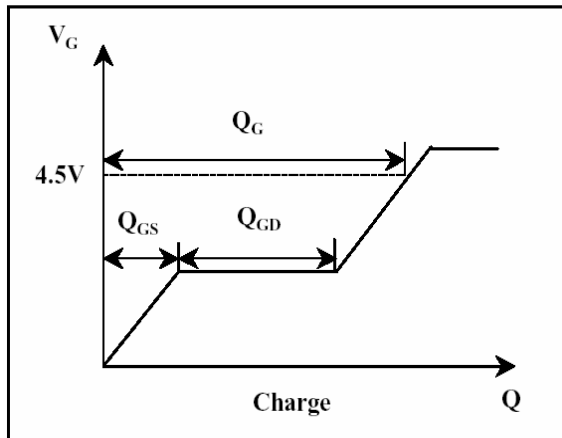

Fig 16. Gate Charge Waveform