

SMB Connector (Low Cost Version)

PSC Series



Conforming Standard
MIL-C-39012

Connector Type
SMB

Frequency Range
DC ~ 4GHz

Characteristic Impedance
50 Ω

Applicable Cable
1.5D-2W, UT-085
RG-316

Lock Type
Push-on

Mounting Type
DIP or SMT



OUTLINE

PSC series is intermateable with SMB connectors which conform to MIL-C-39012 and modified smaller and lighter. The shell and contact are press-fabricated and the insulator is formed by mold to meet low cost requirement.

APPLICATIONS

Base station, Telecom, Measurement equipment

FEATURE

1. VSWR is less than 1.2 at frequency range DC ~ 4GHz.
2. Mating height is 9mm(max.) from PCB surface.
3. Applicable cable is a flexible cable and a semi-flexible cable.

SPECIFICATIONS

Characteristic Impedance	50 Ω
Dielectric Withstanding Voltage	1000V AC(r.m.s) / 1minute
Insulation Resistance	1000M Ω (min.) at 500V DC
Contact Resistance	6m Ω (max.)
Frequency Range	DC ~ 4GHz
VSWR	1.2(max.)
Mating Height	9.0mm(max.) (PSC series)

* The specifications are typical but may not apply to all connectors. Please check the specifications on each item with its drawing from us when you use.

MATERIAL/FINISH



Contact	Copper Alloy / Au Plating
Insulator	Fluorine Resin
Outer Conductor	Copper Alloy / Ni Plating, Au Plating

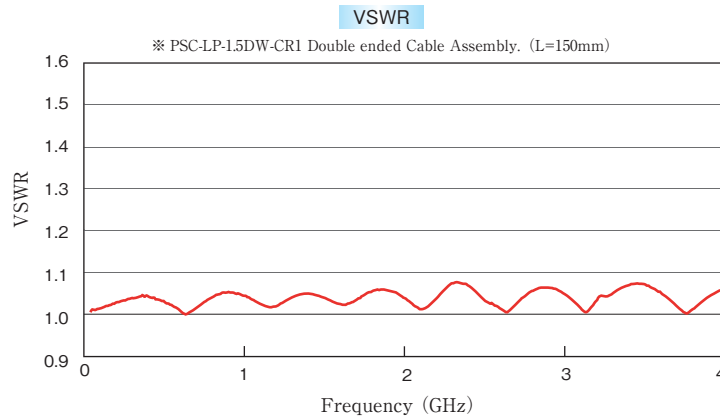

© Please acknowledge that the specification etc. of this catalog might change by the improvement etc. without notice. Moreover, the characteristic and the specification of the published product are the reference values. Please confirm the content with the latest delivery specifications when you use the product.

▶ Plug Connector

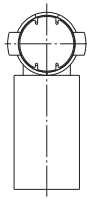
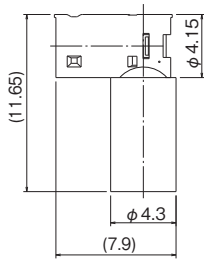

Part Number	Contact	Outer Conductor	Applicable Cable
PSC-LP-1.5DW-CR1	Au	Ni	1.5D-2W Equivalent 1.5D-HQ · SUPER (Fujikura) Equivalent
PSC-LP-1.5DW-CR1-D1		Au	
PSC-LP-316U-CR1	Au	Ni	RG-316/U Equivalent
PSC-LP-316U-CR1-D1		Au	

◎ Please favor us your cable assembly order to assure the performance.
 ※ Appearance is exactly same.

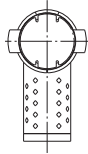
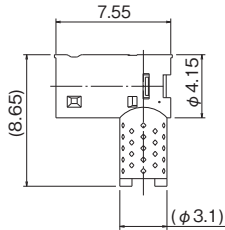

Part Number	Contact	Outer Conductor	Applicable Cable
PSC-LP-FCCAX1-SO	Au	Ni	FCCAXB1 (Nissei) Equivalent (UT-85 Equivalent Semi-flexible Cable)
PSC-LP-FCCAX1-SO-D1		Au	

◎ Please favor us your cable assembly order to assure the performance.

▶ Straight Receptacle Connector

DIP Type

Part Number	Contact	Outer Conductor
PSC-SR-PC	Au	Ni

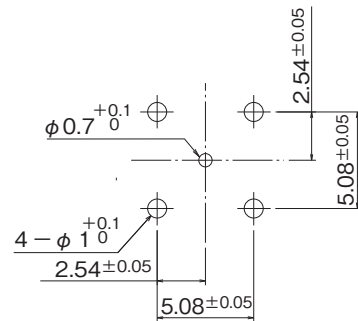
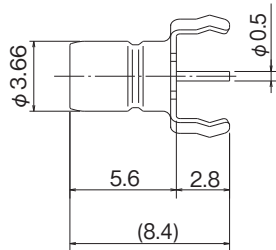
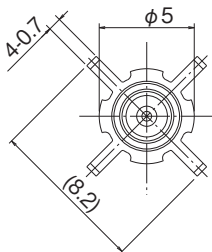

SMT Type

Part Number	Contact	Outer Conductor
PSC-SR-PS-D1	Au	Au

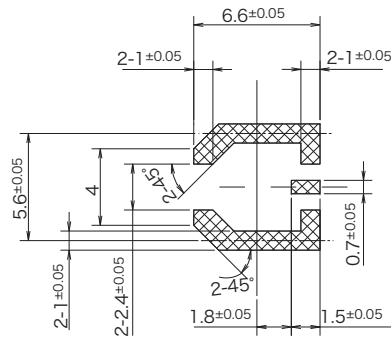
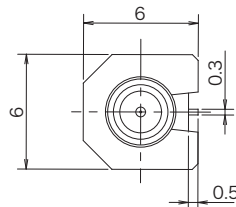
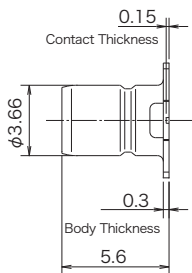

PCB Mounting Dimensions

PCB Land Reference Dimensions

◎ Please acknowledge that the specification etc. of this catalog might change by the improvement etc. without notice.
 Moreover, the characteristic and the specification of the published product are the reference values.
 Please confirm the content with the latest delivery specifications when you use the product.