

EHP-A21/GT31H-PU5/TR

High Power LED – 0.5W



Data Sheet



Features

- ◆ Feature of the device: Small package with high efficiency
- ◆ Typical color temperature: 5650 K.
- ◆ Typical view angle: 115°
- ◆ Typical light flux output: 30 lm @ 150mA.
- ◆ ESD protection.
- ◆ Soldering methods: SMT
- ◆ Grouping parameter: Brightness, Forward Voltage and Chromaticity.
- ◆ Optical efficiency: 57 lm/W.
- ◆ Moisture Sensitivity Level: 2A
- ◆ Color rendering Index: 80(typ.)
- ◆ Thermal resistance (Junction to Heat sink): 40 °C /W
- ◆ The product itself will remain within RoHS compliant version.

Applications

- ◆ Design and effect illumination
- ◆ Interior automotive lighting (e.g. dashboard backlighting)
- ◆ Room lighting (e.g. luminaries, spotlights)
- ◆ Reading light (aircraft, car, bus)
- ◆ Signal and symbol luminaries
- ◆ Marker lights (e.g. steps, exit ways, etc.)
- ◆ Architectural illumination

Materials

Items	Description
Encapsulating Resin	Silicone resin
Electrodes	Ag plating copper alloy
Die attach	Silver paste
Chip	InGaN

EHP-A21/GT31H-PU5/TR
High Power LED – 0.5W



Dimensions

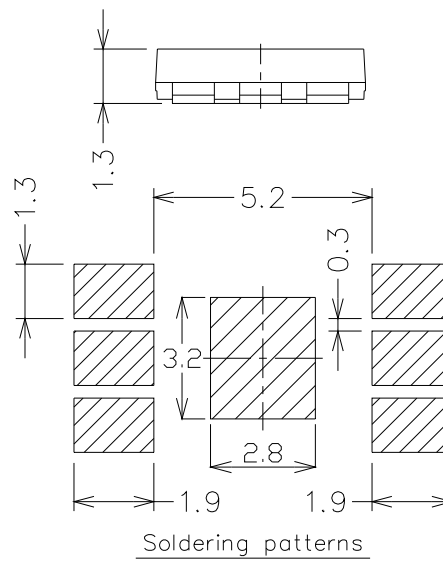
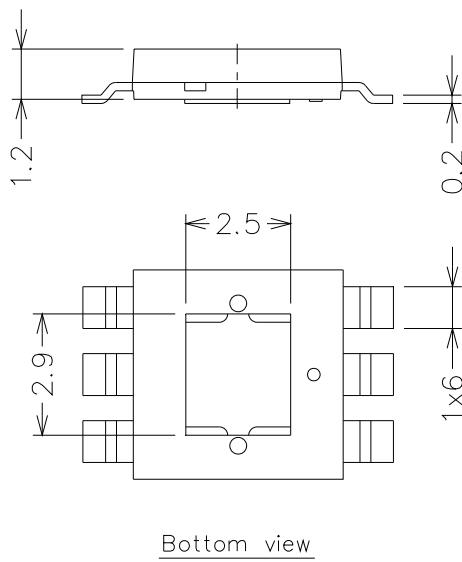
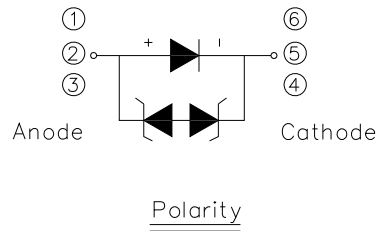
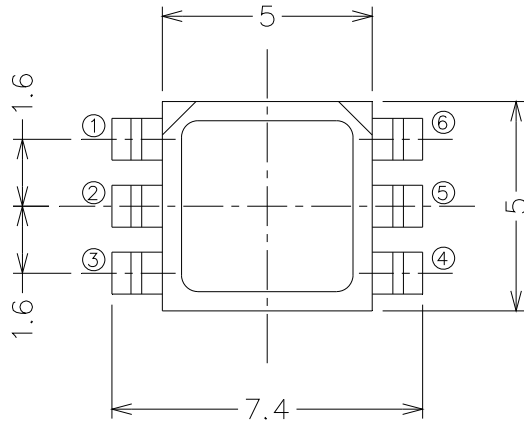

Notes.

1. Dimensions are in millimeters.
2. Tolerances for fixed dimensions are $\pm 0.25\text{mm}$.

EHP-A21/GT31H-PU5/TR

High Power LED – 0.5W



Maximum Ratings ($T_{\text{Soldering}}=25^{\circ}\text{C}$)

Parameter	Symbol	Rating	Unit
DC Operating Current	I_F	180	mA
Pulsed Forward Current ₍₁₎	I_{PF}	200	mA
ESD Sensitivity	ESD	2000	V
Junction Temperature	T_j	125	$^{\circ}\text{C}$
Operating Temperature	$T_{op.}$	-40 ~ +85	$^{\circ}\text{C}$
Storage Temperature	$T_{stge.}$	-40 ~ +100	$^{\circ}\text{C}$
Power Dissipation	P_d	0.5	W
Junction To Heat-Sink Thermal Resistance	R_{th}	40	$^{\circ}\text{C/W}$

Electro-Optical Characteristics ($T_{\text{Soldering}}=25^{\circ}\text{C}$)

Parameter	Symbol	Min	Typ.	Max	Unit	Condition
Brightness ₍₂₎	Φ_v	----	30	----	lm	$I_F=150\text{mA}$
Forward Voltage ₍₃₎	V_F	----	3.55	----	V	
Color Temperature ₍₄₎	CCT	----	5650	----	K	

Note.

1. $t_p \leq 100 \mu\text{s}$, Duty cycle = 0.25
2. Luminous Flux measurement tolerance: $\pm 10\%$.
3. Forward Voltage measurement tolerance: $\pm 0.1\text{V}$.
4. X, Y coordination for white light bin areas refer to EHP-A08-AX08 series White and Warm White Binning (DSE-A08-001).

EHP-A21/GT31H-PU5/TR

High Power LED – 0.5W



Brightness Bin Table

Group	Bin	Min	Typ.	Max
E	1	1.5	----	3
	2	3	----	4
	3	4	----	5
	4	5	----	6
	5	6	----	8
F	1	8	----	10
	2	10	----	13
	3	13	----	17
	4	17	----	20
	5	20	----	23
J	1	23	----	27
	2	27	----	33
	3	33	----	39
	4	39	----	45
	5	45	----	52

Group	Bin	Min	Typ.	Max
K	1	52	----	60
	2	60	----	70
	3	70	----	85
	4	85	----	100
	5	100	----	130
N	1	130	----	160
	2	160	----	200
	3	200	----	250
	4	250	----	300
	5	300	----	400
R	1	400	----	500
	2	500	----	600
	3	600	----	750
	4	750	----	1000
	5	1000	----	1300

EHP-A21/GT31H-PU5/TR

High Power LED – 0.5W



Forward Voltage Bin Table

Group	Bin	Min	Typ.	Max
U1	1	1.75	----	1.85
	2	1.85	----	1.95
	3	1.95	----	2.05
U2	1	2.05	----	2.15
	2	2.15	----	2.25
	3	2.25	----	2.35
U3	1	2.35	----	2.45
	2	2.45	----	2.55
	3	2.55	----	2.65
U4	1	2.65	----	2.75
	2	2.75	----	2.85
	3	2.85	----	2.95

Group	Bin	Min	Typ.	Max
V1	1	2.95	----	3.05
	2	3.05	----	3.15
	3	3.15	----	3.25
V2	1	3.25	----	3.35
	2	3.35	----	3.45
	3	3.45	----	3.55
V3	1	3.55	----	3.65
	2	3.65	----	3.75
	3	3.75	----	3.85
V4	1	3.85	----	3.95
	2	3.95	----	4.05
	3	4.05	----	4.15
V5	1	4.15	----	4.25
	2	4.25	----	4.35
	3	4.35	----	4.45

Group	Bin	Min	Typ.	Max
O	1	4.5	----	5.0
	2	5.0	----	5.5
	3	5.5	----	6.0
	4	6.0	----	6.5
	5	6.5	----	7.0
	6	7.0	----	7.5
	7	7.5	----	8.0
R	1	8.0	----	9.0
	2	9.0	----	10.0
	3	10.0	----	11.0
	4	11.0	----	12.0

White Binning Structure
Cool White

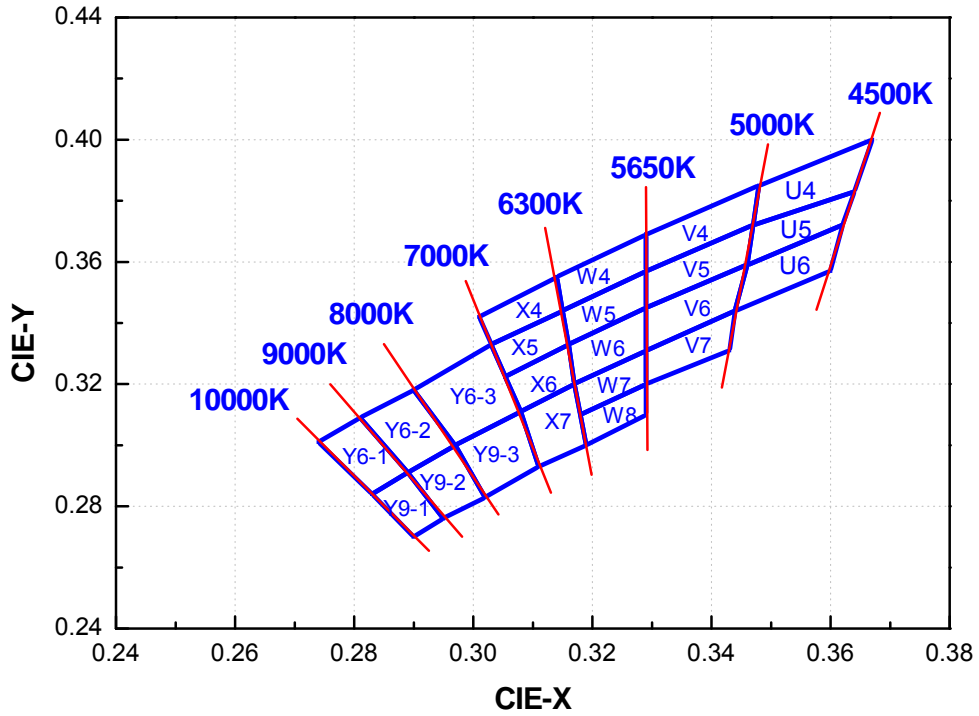

Note.

This datasheet is a product series datasheet with a list of all possible rankings for the entire Everlight high power portfolio. It does not specify exact bins available for any particular package. Please contact a member of your regional Everlight branch to receive specific binning, exact order codes and individual datasheets for a particular high power LED.

Typical Electro-Optical Characteristics Curves

Relative Spectral Distribution,
 $I_F=150\text{mA}$, $T_{\text{soldering}}=25^\circ\text{C}$

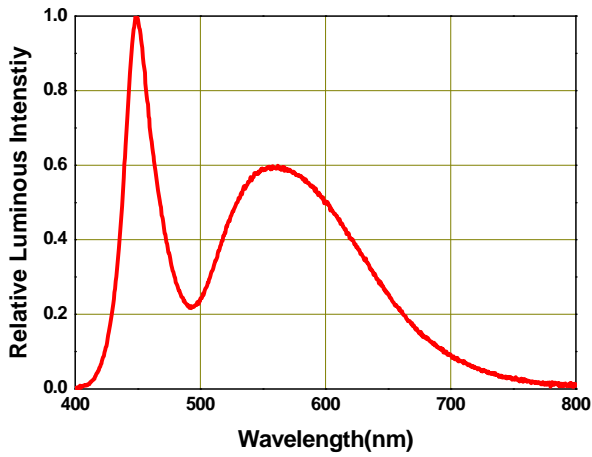

Forward Voltage vs Forward Current,
 $T_{\text{soldering}}=25^\circ\text{C}$

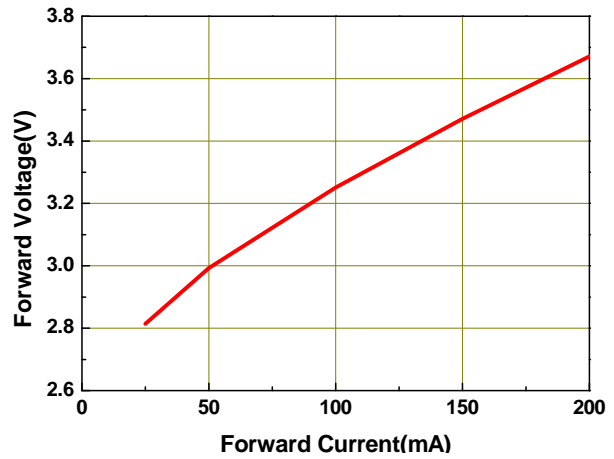

Relative Luminous Intensity vs Forward Current,
 $T_{\text{soldering}}=25^\circ\text{C}$

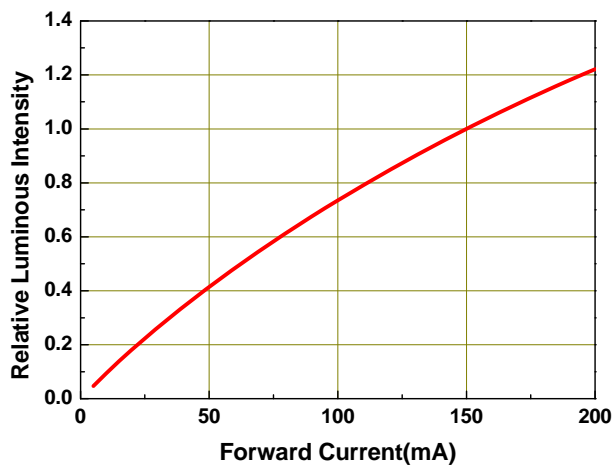

Forward Current Derating Curve,
 Derating based on $T_{\text{JMAX}}=125^\circ\text{C}$

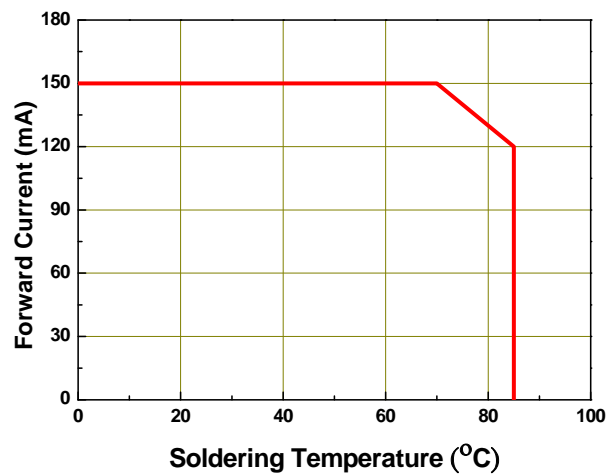

EHP-A21/GT31H-PU5/TR

High Power LED – 0.5W



Typical Representative Spatial Radiation Pattern

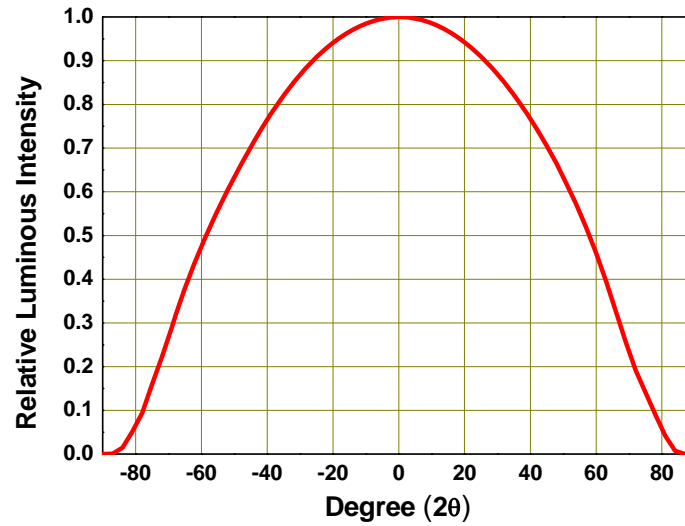

Note.

1. $2\theta_{1/2}$ is the off axis angle from lamp centerline where the luminous intensity is 1/2 of the peak value.
2. View angle tolerance is $\pm 5^\circ$.

EHP-A21/GT31H-PU5/TR

High Power LED – 0.5W



Label explanation

CPN: Customer's Production Number

P/N : Production Number

QTY: Packing Quantity

CAT: Rank of Luminous Flux

HUE: Color Rank

REF: Rank of Forward Voltage

LOT No: Lot Number

MADE IN TAIWAN: Production Place



Reel Dimensions



Note.

1. Dimensions are in millimeters.
2. Tolerances for fixed dimensions are ± 0.1 mm.

Carrier Tape Dimensions: Loaded quantity 2000 PCS per reel

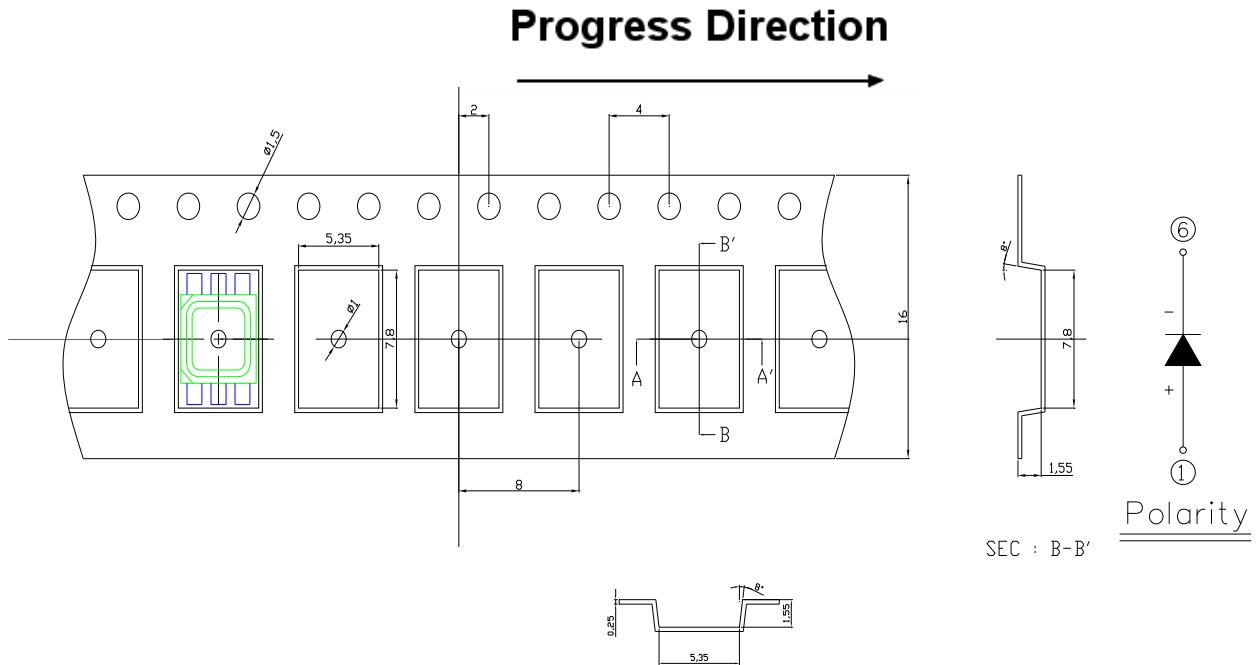

Note.

1. Dimensions are in millimeters.
2. Tolerances for fixed dimensions are $\pm 0.1\text{mm}$.

Moisture Resistant Packaging

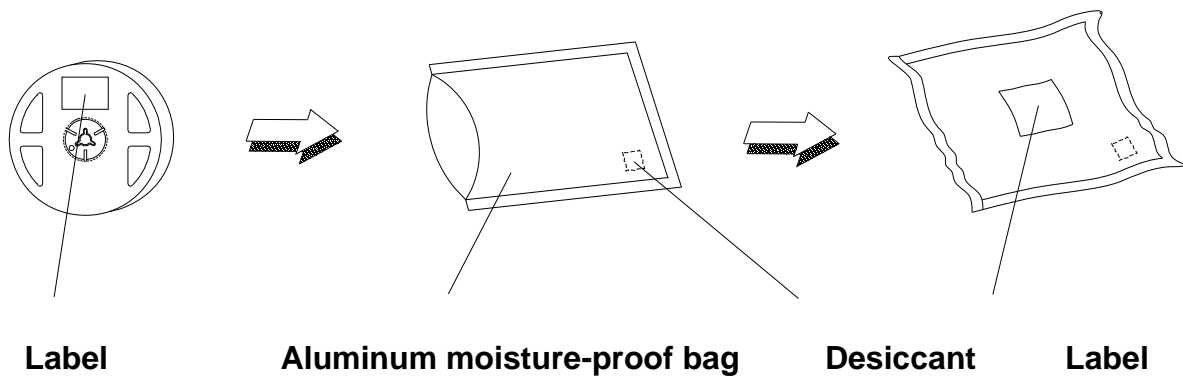

Reliability Data

Stress Test	Stress Condition	Stress Duration
Solderability	Tsol=260°C, 10sec	1 times
Reflow	Tsol=260°C, 5sec, 6min	3 times
Thermal Shock	H : + 100°C 20min. ↓ 20sec. 'L : - 10°C 20min.	200 Cycles
Temperature Cycle	H : + 100°C 15min. ↓ 5min. 'L : - 40°C 15min.	200 Cycles
High Temperature/Humidity Reverse Bias	Ta=85°C , RH=85%	1000hours
High Temperature/Humidity Operation	Ta=85°C , RH=85%, IF=120mA	1000hours
High Temperature Storage	Ta=85°C	1000hours
Low Temperature Storage	Ta=-40°C	1000hours
High Temperature Operation Life #1	Ta=25°C, IF=150mA	1000hours
High Temperature Operation Life #2	Ta=55°C, IF=150mA	1000hours
High Temperature Operation Life #3	Ta=85°C, IF=120mA	1000hours
Low Temperature Operation Life	Ta=-40°C, IF=150mA	1000hours
Power Temperature Cycle	H : + 100°C 15min. ↓ 5min. 'L : - 40°C 15min. IF=120mA, 2min on/off	200cycles

*Im: BRIGHTNESS ATTENUATE DIFFERENCE(1000hrs) < 50%

*VF: FORWARD VOLTAGE DIFFERENCE < 20%

Precautions For Use

Over-current-proof

Although the EHP-A21 series has a conductive ESD protection mechanism, customer must not use the device in reverse and should apply resistors for extra protection. Otherwise, slight voltage shifts may cause significant current change resulting in burn out failure.

1. Storage

- i. Do not open the moisture proof bag before the devices are ready to use.
- ii. Before the package is opened, LEDs should be stored at temperatures less than 30°C and humidity less than 90%.
- iii. LEDs should be used within a year.
- iv. After the package is opened, LEDs should be stored at temperatures less than 30°C and humidity less than 60%.
- v. LEDs should be used within 168 hours (7 days) after the package is opened.
- vi. If the moisture absorbent material (silicone gel) has faded away or LEDs have exceeded the storage time, baking treatment should be implemented based on the following conditions: pre-curing at 60±5°C for 24 hours.

2. Thermal Management

- i. For maintaining the high flux output and achieving reliability, EHP-A21 series LEDs should be mounted on a metal core printed circuit board (MCPCB) or other kinds of heat sink with proper thermal connection to dissipate approximately 0.5W of thermal energy at 150mA operation.
- ii. Heat dissipation or thermal conduction design is strongly recommended on PCB or MCPCB for reflow soldering purposes. Please refer to soldering patterns on Page 2.
- iii. Sufficient thermal management must be implemented. Otherwise, the junction temperature of die may exceed over the limit at high current driving conditions and the LEDs' lifetime may be decrease dramatically.
- iv. For further thermal management suggestions, please consult the Everlight Design Guide or local representatives for assistance.
- v. Special thermal designs are also recommended to take in outer heat sink design, such as FR4 PCB on Aluminum with thermal vias or FPC on Aluminum with thermal conductive adhesive, etc.
- vi. Sufficient thermal management must be conducted, or the die junction temperature will be over the limit under large electronic driving and LED lifetime will decrease critically.

3. Proper Handling

To avoid contamination of materials, damage of internal components, and shortening of LED lifetime, do not subject LEDs to conditions as those listed below.

Bare Hand

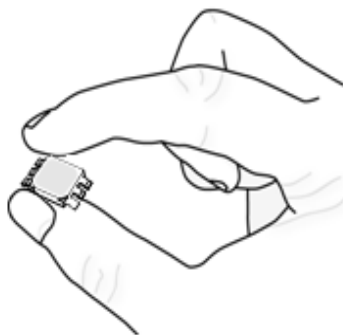

When handling the product, do not apply direct pressure on the resin.

Tweezers



Do not touch the resin to avoid scratching or other damage.

Pick and Place Nozzle for Surface Mount Assembly.

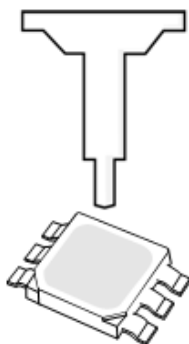

Avoid directly contacting with nozzle.

During Module Assembly

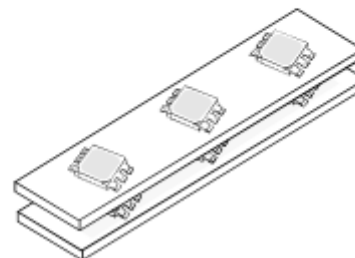

Do not stack the modules together, it could damage the resin or scratch the lens.

4. Soldering Iron

i. For Reflow Process

- a. EHP-A21 series are suitable for SMT process.
- b. Curing of glue in oven according to standard operation flow processes.

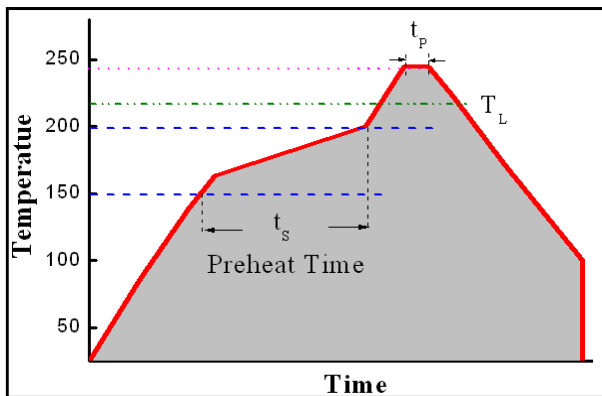

Profile Feature	Lead Free Assembly
Ramp-Up Rate	2-3 °C/S
Preheat Temperature	150-200 °C
Preheat Time (ts)	60-120 S
Liquid Temperature (TL)	217 °C
Time maintained above TL	60-90 S
Peak Temperature (Tp)	240±5 °C
Peak Time (tp)	Max 20 S
Ramp-Down Rate	3-5 °C/S

- c. Reflow soldering should not be done more than twice.
- d. In soldering process, stress on the LEDs during heating should be avoided.
- e. After soldering, do not warp the circuit board.

ii. For Manual Soldering Process

- a. For prototype builds or small series production runs it is possible to place and solder the LED by hand.
- b. Dispense thermal conductive glue or grease on the substrates and follow its curing specifications. Gently press LED housing to closely connect LED and substrate.
- c. It is recommended to hand solder the leads with a solder tip temperature of 280°C for less than 3 second, at a time with a soldering iron of less than 25W. Solder at intervals of two seconds or more.
- d. Take caution and be aware that damaged products are often a result of improper hand soldering technique.

Revision History

Page	Subjects(major change in previous version)	Date of change

■ Prepared date:	13-Jul-2009	■ Device No.:	DHE-0000766
■ Created by:	Jessie Chueh	■ Rev.:	1

For product information and a complete list of distributors, please go to our web site : www.everlight.com

Everlight Electronics Co., Ltd. and the logo are trademarks of Everlight Electronics Co., Ltd. in the Taiwan and other countries. Data subject to change.

Copyright © 2005-2009 Everlight Electronics Co., Ltd.. All rights reserved.