

HIGH TEMPERATURE CERAMIC EUROBLOCKS™

Suitable for use in high temperature applications up to 600°C (1112°F).

Applications include hot melt glue guns, furnaces, heaters, process equipment and machinery. Terminal blocks are offered with mounting holes for panel mounting or free floating applications.

- Compact, space saving
- Tubular screw clamp
- Free float or panel mount
- Temperature range: 600°C (1112°F)
- Standard color: white
- Material Housing: ceramic
- Clamp: brass
- Screws: zinc plated steel



| Insulation Material | Ceramic | | Ceramic | | Ceramic | |
|-------------------------|-----------|-----------|-----------|-----------|----------|----------|
| Approvals | | | | | | |
| Wire Range | 24-12 AWG | 24-12 AWG | 22-10 AWG | 20-10 AWG | 20-6 AWG | 18-6 AWG |
| Voltage Rating | 300V | 300V | 300V | 300V | 300V | 300V |
| Current Rating | 30 A | 20 A | 40 A | 30 A | 76 A | 65 A |
| No. of Poles | Cat. No. | Std. Pk. | Cat. No. | Std. Pk. | Cat. No. | Std. Pk. |
| 1 (free floating) | CB4/1 | 50 | CB6/1 | 50 | | |
| 2 (free floating) | CB4/2 | 50 | | | | |
| 2 (with mounting holes) | CB4/2H | 50 | CB6/2H | 50 | CB16/2H | 50 |
| 3 (free floating) | CB4/3 | 50 | | | | |
| 3 (with mounting holes) | CB4/3H | 50 | CB6/3H | 50 | CB16/3H | 50 |

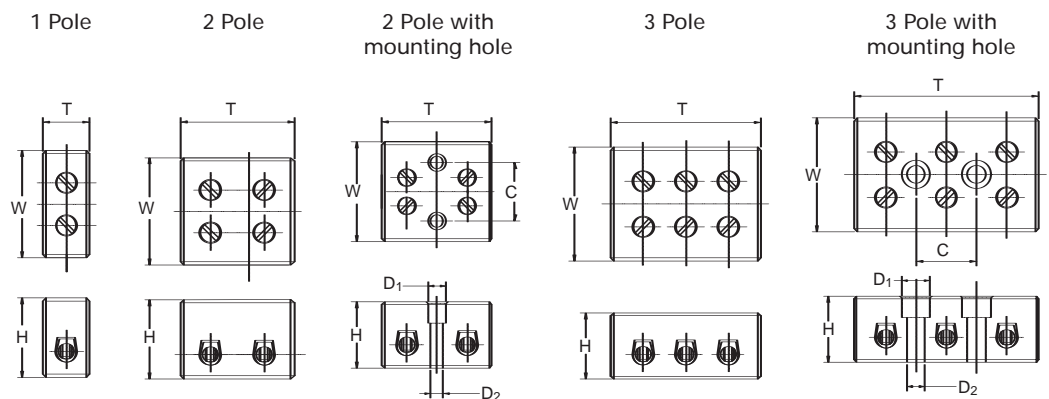

| | | Dimensions mm | | | | | | | Fixing Screw | Stripping Length |
|---------|--------|---------------|----|------|------|----|-----|-------|--------------|------------------|
| | | W | T | H | C | D1 | D2 | | | |
| CB4/1 | 1 POLE | 23 | 11 | 18.5 | * | | | | 6 | |
| CB4/2 | 2 POLE | 23 | 18 | 18.5 | * | | | | 6 | |
| CB4/2H | 2 POLE | 23 | 24 | 18.5 | 14.6 | 6 | 3.5 | M3X16 | 6 | |
| CB4/3 | 3 POLE | 25 | 25 | 18.5 | * | | | | 6 | |
| CB4/3H | 3 POLE | 25.4 | 36 | 18.5 | 13 | 6 | 3.5 | M3X16 | 6 | |
| CB6/1 | 1 POLE | 25 | 12 | 19.5 | * | | | | 6 | |
| CB6/2H | 2 POLE | 25.5 | 26 | 19.5 | 12.6 | 6 | | M3X16 | 6 | |
| CB6/3H | 3 POLE | 25.5 | 41 | 19.5 | 15 | 6 | | M3X16 | 6 | |
| CB16/2H | 2 POLE | 28 | 31 | 23.2 | 16.5 | 6 | 3.5 | M3X20 | 8.5 | |
| CB16/3H | 3 POLE | 27.5 | 48 | 23.2 | 17 | 6 | 3.5 | M3X20 | 8.5 | |

Note: All dimensions are shown in mm, to convert to inches please divide by 25.4.

MINI FEED-THROUGH

15mm DIN Rail

For wire-to-wire connecting in control, automation, instrumentation and power distribution applications.

Altech "miniature" terminal blocks offer tremendous space advantage as demanded by certain wiring configurations.

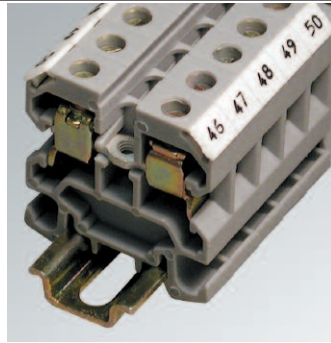

FUSE BLOCKS

Certain electrical and control systems require protection by fuses. The terminal has a hinged carrier that has a specially designed space for a cartridge type glass fuse of size Ø5 x 20 or Ø5 x 25 mm. The fuse can be engaged or disengaged by the movement of the carrier.







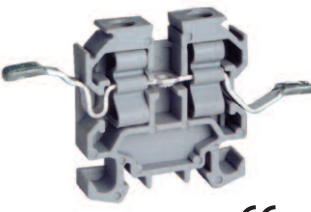
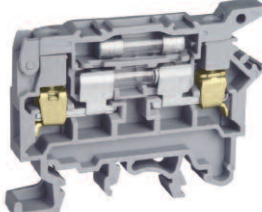
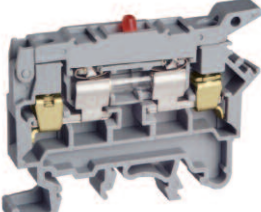

Altech fuse terminals are also available with light indication - CSFL 4U (L). A specially designed built-in circuit gives light indication in the event of fuse blow out.

Fuses are sold separately by Altech, see page 34 for details.

| | CMT4 | | | CMT4S | | |
|---------------------|---|-------------|-----------|--|----------------|-----------|
| Terminal Width | 6 mm | | | 6 mm | | |
| Height x Length | 29 x 27 mm | | | 29 x 46 mm | | |
| Stripping Length | 9 mm | | | 9 mm | | |
| Insulation Material | Polyamide 6.6 | | | Polyamide 6.6 | | |
| Type of Connection | 2 screw clamps & 1 tapped hole for cross connection | | | 2 screw clamps, 2 solder points and 1 tapped hole for cross connection | | |
| Type of Fuse Used | — | | | — | | |
| Approvals | | | | | | |
| Wire Range | 22-10 AWG | 0.5-4 sq.mm | 22-10 AWG | 22-12 AWG | Upto 1.5 sq.mm | 22-10 AWG |
| Voltage Rating | 300 V | 400 V | 300 V | 300 V | 160 V | 300 V |
| Current Rating | 35 A | 32 A | 35 A | 25 A | 15 A | 35 A |
| Torque | 6 lb-in | 0.5 Nm | 7 lb-in | 7 lb-in | 0.5 Nm | 7 lb-in |

| | | Cat. No. | Std. Pk. | Cat. No. | Std. Pk. |
|--|--|--|---------------------------------------|--|---------------------------------------|
| Terminal Block | | CMT4 | 100 | CMT4S | 50 |
| End Plate | | EPCMT4 | 50 | EPCMT4 | 50 |
| Isolation Partition | | PPCMT4 | 50 | PPCMT4 | 50 |
| DIN Rail | | | | | |
| <i>for ordering information refer to page 62</i> | | | | | |
| End Stop | | CA602 | 100 | CA602 | 50 |
| <i>for ordering information refer to page 63</i> | | | | | |
| Internal Jumper | 2 pole 3 pole 4 pole 10 pole | CA727/2 CA727/3 CA727/4 CA727/10 | 100 50 50 10 | CA727/2 CA727/3 CA727/4 CA727/10 | 100 50 50 10 |
| Insulated Internal Jumper | 2 pole 3 pole 4 pole 10 pole | CA747/2 CA747/3 CA747/4 CA747/10 | 100 50 50 10 | CA747/2 CA747/3 CA747/4 CA747/10 | 100 50 50 10 |
| Current Bars | 2 pole 3 pole 4 pole 10 pole 10 pole (breakable) 100 pole | CA703/1 CA704/1 CA705/1 CA732/10 CA732/10-A CA732/100 | 100 100 100 100 100 10 | CA703/1 CA704/1 CA705/1 CA732/10 CA732/10-A CA732/100 | 100 100 100 100 100 10 |
| Shorting Sleeve & Screw | | CA607/S/Q | 100 | CA607/S/Q | 100 |
| External Jumper | 2 pole 3 pole 4 pole 10 pole | CA714/2 CA714/3 CA714/4 CA714/10 | 100 100 50 25 | CA714/2 CA714/3 CA714/4 CA714/10 | 100 100 50 25 |
| Marking Tags (MT Type) | (MT Type on Lever) | MT2 | 100 | MT2 | 100 |

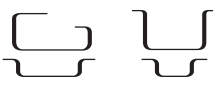
* Add required voltage to part number as a suffix, i.e. CSFL4U(L)/24 fo 24V DC

| CMT4SU | | | CSFL4U | | | CSFL4U(L)* | | | CGMT4 | | |
|---|-----------------|--|---|-----------------|--|--|-----------------|--|---|-----------------|--|
|  | | |  | | |  | | |  | | |
| CE | | | | | | | | | CE | | |
| 6 mm | | | 8 mm | | | 8 mm | | | 6 mm | | |
| 29 x 35.5 mm | | | 43 x 58 mm | | | 43 x 58 mm | | | 28.5 x 27 mm | | |
| 9 mm | | | 9.5 mm | | | 9.5 mm | | | 9 mm | | |
| Polyamide 6.6 | | | Polyamide 6.6 | | | Polyamide 6.6 | | | Polyamide 6.6 | | |
| 2 uneven level solder points & 1 tapped hole for cross connection | | | 2 screw clamps | | | 2 screw clamps | | | 2 screw clamps | | |
| — | | | Ø5x20, Ø5x25mm | | | Ø5x20, Ø5x25mm | | | — | | |
|  | | |  | | |  | | |  | | |
| 22-14 AWG Upto 1.5 sq.mm 22-14 AWG | | | 22-10 AWG 0.5-4 sq.mm 22-10 AWG | | | 22-10 AWG 0.5-4 sq.mm 22-10 AWG | | | 22-10 AWG 0.5-4 sq.mm 22-10 AWG | | |
| 300 V 160 V 300 V | | | 600 V 600 V 600 V | | | 600 V 600 V 600 V | | | | | |
| 15 A 15 A 20 A | | | 6.3 A 6.3 A 8 A | | | 6.3 A 6.3 A 8 A | | | | | |
| — — — | | | 7 lb-in 0.5 Nm 7 lb-in | | | 7 lb-in 0.5 Nm 7 lb-in | | | 7 lb-in 0.5 Nm 7 lb-in | | |
| Cat. No. | Std. Pk. | | Cat. No. | Std. Pk. | | Cat. No. | Std. Pk. | | Cat. No. | Std. Pk. | |
| CMT4SU | 100 | | CSFL4U | 100 | | CSFL4U(L)* | 100 | | CGMT4 | 50 | |
| EPCMT4 | 50 | | EPCSFL4U | 50 | | EPCSFL4U | 50 | | | | |
| PPCMT4 | 50 | | PPCSFL4U | 50 | | PPCSFL4U | 50 | | | | |
|  | | |  | | |  | | |  | | |
| CA602 | 50 | | CA602 | 100 | | CA602 | 100 | | | | |
| CA727/2 | 100 | | | | | | | | | | |
| CA727/3 | 50 | | | | | | | | | | |
| CA727/4 | 50 | | | | | | | | | | |
| CA727/10 | 10 | | | | | | | | | | |
| CA747/2 | 100 | | | | | | | | | | |
| CA747/3 | 50 | | | | | | | | | | |
| CA747/4 | 50 | | | | | | | | | | |
| CA747/10 | 10 | | | | | | | | | | |
| CA703/1 | 10 | | | | | | | | | | |
| CA704/1 | 10 | | | | | | | | | | |
| CA705/1 | 10 | | | | | | | | | | |
| CA732/10 | 10 | | | | | | | | | | |
| CA732/10-A | 100 | | | | | | | | | | |
| CA732/100 | 10 | | | | | | | | | | |
| CA607/S/Q | 10 | | | | | | | | | | |
| | | | CA711/2 | 100 | | CA711/2 | 100 | | | | |
| | | | CA711/3 | 100 | | CA711/3 | 100 | | | | |
| | | | CA711/4 | 50 | | CA711/4 | 50 | | | | |
| | | | CA711/10 | 25 | | CA711/10 | 25 | | | | |
| MT2 | 100 | | MT8 | 100 | | MT8 | 100 | | MT2 | 100 | |
| | | | MT2 | 100 | | MT2 | 100 | | | | |

MINI FEED-THROUGH

Panel Mount

For use when space constraints require extremely compact solutions and internal jumping is required.

Individual components can be used to build your own assemblies. Just snap the required number of terminal block components together and place a Mounting Section on each end.

The CMB 4 accepts internal jumpers and standard marking tags.

- Extremely compact and cost effective
- High density
- Screw-cage clamp
- Internal jumping provision
- Polyamide 6.6
- Standard color: gray

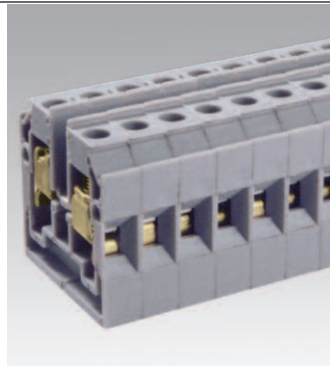

CMB4

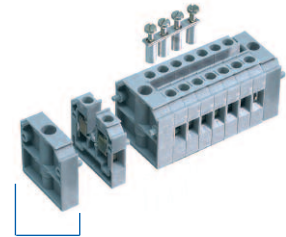

EP CMB4



| | | | |
|---------------------|---|-------------|-----------|
| Terminal Width | 6 mm | | |
| Height x Length | 28 x 27 mm | | |
| Stripping Length | 9 mm | | |
| Insulation Material | Polyamide 6.6 | | |
| Type of Connection | 2 screw clamps & 1 lapped hole for cross connection | | |
| Approvals | | | |
| Wire Range | 22-10 AWG | 0.5-4 sq.mm | 22-10 AWG |
| Voltage Rating | 300 V | 400 V | 300 V |
| Current Rating | 35 A | 32 A | 35 A |
| Torque | 7 lb-in | 0.5 Nm | 7 lb-in |

Preassembled blocks are also available for quick and easy installations.
See Dimensions below.

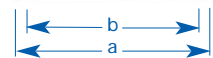

Dimensions mm (in.)
CMB4

| Terminal Block | Cat. No. | Std. Pk. | |
|-------------------------|---------------------------|------------|---------|
| CMB4 | CMB4 | 100 | |
| Mounting Section | EPCMB4 | 50 | |
| Separator Plate | SPCMB4 | 100 | |
| Mounting Screw* | | | |
| Internal Jumper | 2 pole | CA727/2 | 100 |
| | 3 pole | CA727/3 | 50 |
| | 4 pole | CA727/4 | 50 |
| | 10 pole | CA727/10 | 10 |
| | Insulated Internal Jumper | 2 pole | CA747/2 |
| 3 pole | | CA747/3 | 50 |
| 4 pole | | CA747/4 | 50 |
| 10 pole | | CA747/10 | 10 |
| Current Bars | | 2 pole | CA703/1 |
| | 3 pole | CA704/1 | 100 |
| | 4 pole | CA705/1 | 100 |
| | 10 pole | CA732/10 | 100 |
| | 10 pole (breakable) | CA732/10-A | 100 |
| | 100 pole | CA732/100 | 10 |
| Shorting Sleeve & Screw | | CA607/S/Q | 100 |
| External Jumper | 2 pole | CA714/2 | 100 |
| | 3 pole | CA714/3 | 100 |
| | 4 pole | CA714/4 | 50 |
| | 10 pole | CA714/10 | 25 |
| | Marking Tags (MT Type) | MT2 | 100 |

| Cat No. | No. of Poles | Width (a) | Hole Spacing (b) |
|---------|--------------|------------|------------------|
| CMB4/2 | 2 | 26 (1.02) | 19 (0.75) |
| CMB4/3 | 3 | 32 (1.26) | 25 (0.98) |
| CMB4/4 | 4 | 38 (1.50) | 31 (1.22) |
| CMB4/5 | 5 | 44 (1.73) | 37 (1.46) |
| CMB4/6 | 6 | 50 (1.97) | 43 (1.69) |
| CMB4/7 | 7 | 56 (2.20) | 49 (1.93) |
| CMB4/8 | 8 | 62 (2.44) | 55 (2.17) |
| CMB4/9 | 9 | 68 (2.68) | 61 (2.40) |
| CMB4/10 | 10 | 74 (2.91) | 67 (2.64) |
| CMB4/11 | 11 | 80 (3.15) | 73 (2.87) |
| CMB4/12 | 12 | 86 (3.39) | 79 (3.11) |
| CMB4/13 | 13 | 92 (3.62) | 85 (3.35) |
| CMB4/14 | 14 | 98 (3.86) | 91 (3.58) |
| CMB4/15 | 15 | 104 (4.09) | 97 (3.82) |
| CMB4/16 | 16 | 110 (4.33) | 103 (4.06) |
| CMB4/17 | 17 | 116 (4.57) | 109 (4.29) |
| CMB4/18 | 18 | 122 (4.80) | 115 (4.53) |
| CMB4/19 | 19 | 128 (5.04) | 121 (4.76) |
| CMB4/20 | 20 | 134 (5.28) | 127 (5.00) |
| CMB4/21 | 21 | 140 (5.51) | 133 (5.24) |
| CMB4/22 | 22 | 146 (5.75) | 139 (5.47) |
| CMB4/23 | 23 | 152 (5.98) | 145 (5.71) |
| CMB4/24 | 24 | 158 (6.22) | 151 (5.94) |

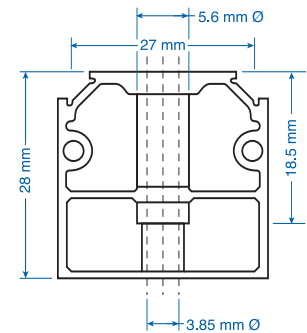

Mounting Section
EPCMB4

* Any length M3 screw may be used.

BUSBAR SYSTEM

















Panel Mount





A quick reliable solution for ground, neutral or low voltage distribution applications. The Busbar System consists of a busbar, busbar supports, and screw clamp terminals for terminating wires

NEB 10 (10 x 3 mm) and NEB 6 (6 x 6 mm), tin plated copper busbars are available in one meter lengths. Both have a 140A current carrying capacity.

NES plastic support with fixing screws for holding 10 x 3 & 6 x 6 busbar makes placing of busbar an easy task. Busbars up to 200 mm length should be supported at ends by two busbar supports. For busbars exceeding 200 mm length, it is recommended to provide intermediate busbar support. Easy to operate CENC clamp secures wire to the busbar.



| | CENC4 | CENC16 | CENC35 |
|---------------------|---|---|---|
| |  |  |  |
| |  |  |  |
| |  |  |  |
| Terminal Width | 7.5 mm | 9.8 mm | 14.5 mm |
| Height x Length | 30 x 23.3 mm | 36 x 23.3 mm | 45 x 27.3 mm |
| Stripping Length | 12 mm | 16 mm | 16 mm |
| Insulation Material | Polyamide 6.6 | Polyamide 6.6 | Polyamide 6.6 |
| Type of Connection | 1 screw clamp connection | 1 screw clamp connection | 1 screw clamp connection |
| Approvals |    |    |    |
| Wire Range | 22-12 AWG 0.5-6 sq.mm 22-12 AWG | 9-6 AWG 6-16 sq.mm 10-6 AWG | 7-2 AWG 10-35 sq.mm 8-2 AWG |
| Current Rating* | 25 A 41 A | 76 A 76 A | 125 A 125 A |
| Torque | 14 lb-in 0.8 Nm 14 lb-in | 14 lb-in 2.0 Nm 17.5 lb-in | 25 lb-in 2.5 Nm 25 lb-in |

| | Cat. No. | Std. Pk. | Cat. No. | Std. Pk. | Cat. No. | Std. Pk. |
|---|----------|----------|----------|----------|----------|----------|
| Terminal Block Green Cap ** | CENC4 | 50 | CENC16 | 50 | CENC35 | 50 |
| Busbar (10 x 3 mm)  | NEB10 | 1 m | NEB10 | 1 m | NEB10 | 1 m |
| Busbar (6 x 6 mm)  | NEB6 | 1 m | NEB6 | 1 m | NEB6 | 1 m |
| Plastic Support with Fixing Screw  | NES | 50 | NES | 50 | NES | 50 |
| End Clamp/Bus bar support for rail mounting | CA202 | 50 | CA202 | 50 | CA202 | 50 |
| Marking Tags (MT Type)  | MT5 | 100 | MT6 | 100 | MT6 | 100 |

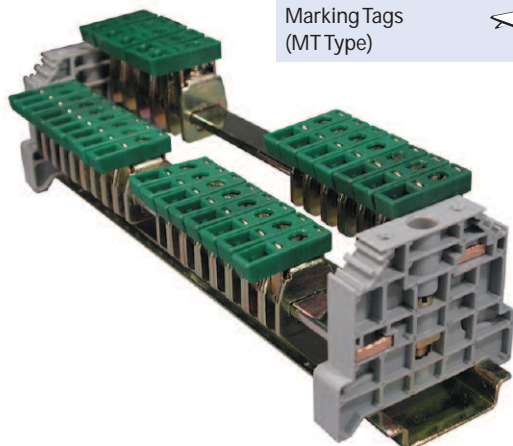

* 140A current carrying capacity of busbar should be taken into account while connecting loads.

** Consult for other available colors.