

Descriptions

This series of fixed-voltage monolithic integrated-circuit voltage regulators is designed for a wide range of applications. These applications include on-card regulation for elimination of Noise and distribution problems associated with single-point regulation. In addition, they can be used with power-pass elements to make high-current voltage regulators. Each of these regulators can deliver up to 100mA of output current. The internal limiting and thermal shutdown features of these regulators make them essentially immune to overload. When used as a replacement for a Zener diode-resistor combination, an effective improvement in output impedance can be obtained together with lower-bias current.

Features

- 3-Terminal Regulators
- Output Current of 100mA
- Thermal Shutdown Protection
- Short-Circuit Limit Protection

Ordering Information

Type NO.	Marking	Package Code
S78LxxL	S78L□□L	TO-92L
□□: Voltage Code (05:5V, 06:6V, 08:8V, 09:9V, 10:10V, 12:12V, 15:15V, 18:18V, 24:24V)		

Outline Dimensions (Unit : mm)

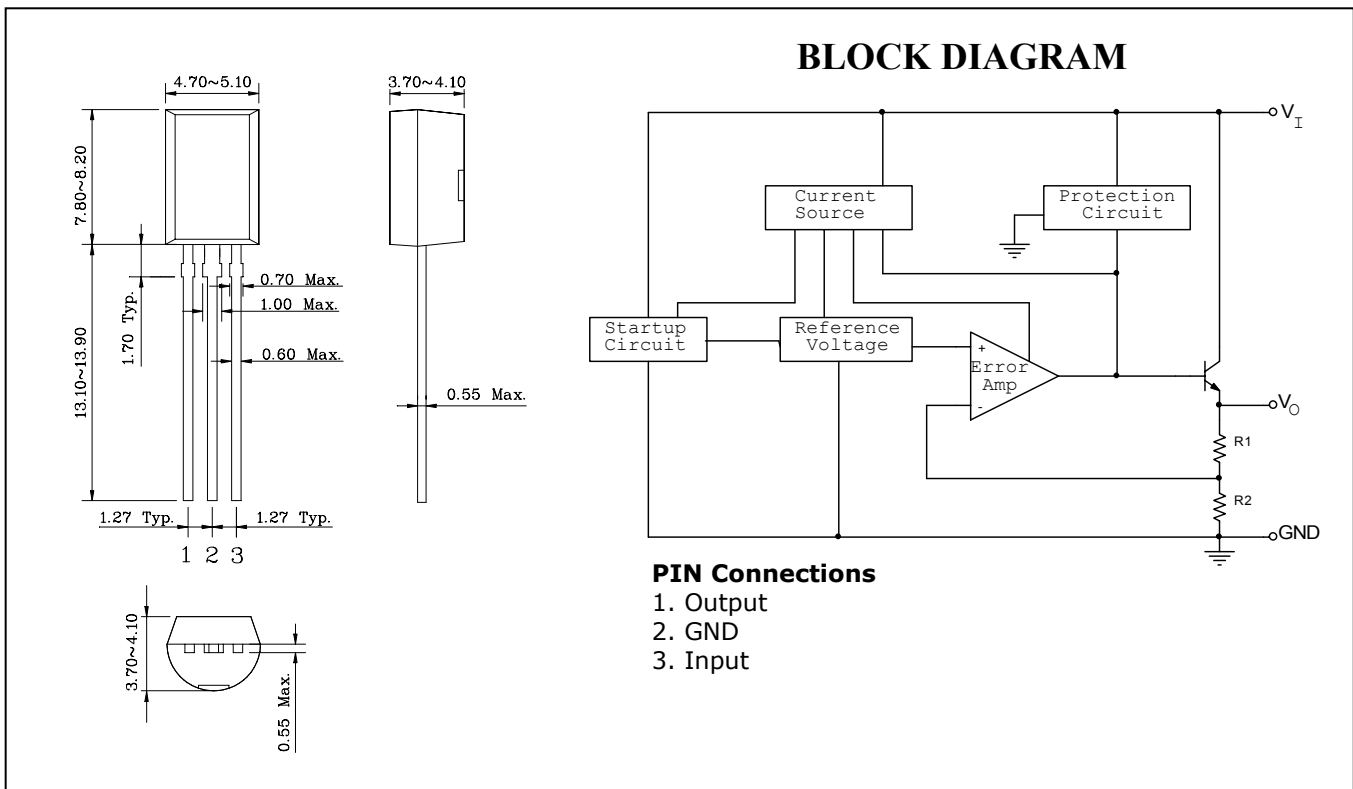

Absolute maximum ratings

[Ta=25°C]

Characteristics	Symbol	Rating	Unit
Input Voltage	V _I	S78L05L Thru S78L10L	30
		S78L12L Thru S78L18L	35
		S78L24L	40
Power Dissipation	P _D	1	W
Junction Temperature	T _J	150	°C
Operating temperature range	T _{opr}	-40 ~ +85	°C
Storage temperature range	T _{stg}	-55 ~ +150	°C

Device Selection Guide

Device	Output Voltage
S78L05L	5.0V
S78L06L	6.0V
S78L08L	8.0V
S78L09L	9.0V
S78L10L	10V
S78L12L	12V
S78L15L	15V
S78L18L	18V
S78L24L	24V

Electrical Characteristics

(Electrical Characteristics at $V_I=10V$, $I_O=40mA$, $C_I=0.33\ \mu F$, $C_O=0.1\ \mu F$, $0^\circ C \leq T_J \leq 125^\circ C$, Unless otherwise specified)

Parameter	Symbol	Test Condition*		S78L05L			Unit
				Min.	Typ.	Max.	
Output Voltage**	V_O		$T_J=25^\circ C$	4.80	5.00	5.20	V
		$I_O=1mA \sim 40mA$ $V_I=7V \sim 20V$		4.75	-	5.25	
		$I_O=1mA \sim 70mA$ $V_I=10V$		4.75	-	5.25	
Line Regulation	$\Delta V_{O(\Delta V_I)}$	$V_I=7V \sim 20V$	$T_J=25^\circ C$	-	32	150	mV
		$V_I=8V \sim 20V$		-	26	100	
Load Regulation	$\Delta V_{O(\Delta I_L)}$	$I_O=1mA \sim 100mA$	$T_J=25^\circ C$	-	15	60	mV
		$I_O=1mA \sim 40mA$		-	8	30	
Quiescent Current	I_{QC}		$T_J=25^\circ C$	-	3.8	6	mA
Quiescent Current Change	ΔI_{QC}	$V_I=8V \sim 20V$		-	-	1.5	mA
		$I_O=1mA \sim 40mA$		-	-	0.1	
Dropout Voltage	V_{DROP}		$T_J=25^\circ C$	-	1.7	-	V
Ripple Rejection	RR	$V_I=8V \sim 18V$, $f=120Hz$		41	49	-	dB

Electrical Characteristics

(Electrical Characteristics at $V_I=11V$, $I_O=40mA$, $C_I=0.33\ \mu F$, $C_O=0.1\ \mu F$, $0^\circ C \leq T_J \leq 125^\circ C$, Unless otherwise specified)

Parameter	Symbol	Test Condition*		S78L06L			Unit
				Min.	Typ.	Max.	
Output Voltage**	V_O		$T_J=25^\circ C$	5.75	6.00	6.25	V
		$I_O=1mA \sim 40mA$ $V_I=8V \sim 20V$		5.70	-	6.30	
		$I_O=1mA \sim 70mA$ $V_I=11V$		5.70	-	6.30	
Line Regulation	$\Delta V_{O(\Delta V_I)}$	$V_I=8V \sim 20V$	$T_J=25^\circ C$	-	35	175	mV
		$V_I=9V \sim 20V$		-	29	125	
Load Regulation	$\Delta V_{O(\Delta I_L)}$	$I_O=1mA \sim 100mA$	$T_J=25^\circ C$	-	16	80	mV
		$I_O=1mA \sim 40mA$		-	9	40	
Quiescent Current	I_{QC}		$T_J=25^\circ C$	-	3.9	6	mA
Quiescent Current Change	ΔI_{QC}	$V_I=9V \sim 20V$		-	-	1.5	mA
		$I_O=1mA \sim 40mA$		-	-	0.1	
Dropout Voltage	V_{DROP}		$T_J=25^\circ C$	-	1.7	-	V
Ripple Rejection	RR	$V_I=9V \sim 19V$, $f=120Hz$		40	48	-	dB

Electrical Characteristics

(Electrical Characteristics at $V_I=14V$, $I_O=40mA$, $C_I=0.33\ \mu F$, $C_O=0.1\ \mu F$, $0^\circ C \leq T_J \leq 125^\circ C$, Unless otherwise specified)

Parameter	Symbol	Test Condition*		S78L08L			Unit
				Min.	Typ.	Max.	
Output Voltage**	V_O		$T_J=25^\circ C$	7.7	8.0	8.3	V
		$I_O=1mA \sim 40mA$ $V_I=10.5V \sim 23V$		7.6	-	8.4	
		$I_O=1mA \sim 70mA$ $V_I=14V$		7.6	-	8.4	
Line Regulation	$\Delta V_{O(\Delta V_I)}$	$V_I=10.5V \sim 23V$	$T_J=25^\circ C$	-	42	175	mV
		$V_I=11V \sim 23V$		-	36	125	
Load Regulation	$\Delta V_{O(\Delta I_L)}$	$I_O=1mA \sim 100mA$	$T_J=25^\circ C$	-	18	80	mV
		$I_O=1mA \sim 40mA$		-	10	40	
Quiescent Current	I_{QC}		$T_J=25^\circ C$	-	4	6	mA
Quiescent Current Change	ΔI_{QC}	$V_I=11V \sim 23V$		-	-	1.5	mA
		$I_O=1mA \sim 40mA$		-	-	0.1	
Dropout Voltage	V_{DROP}		$T_J=25^\circ C$	-	1.7	-	V
Ripple Rejection	RR	$V_I=13V \sim 23V$, $f=120Hz$		37	46	-	dB

Electrical Characteristics

(Electrical Characteristics at $V_I=16V$, $I_O=40mA$, $C_I=0.33\ \mu F$, $C_O=0.1\ \mu F$, $0^\circ C \leq T_J \leq 125^\circ C$, Unless otherwise specified)

Parameter	Symbol	Test Condition*		S78L09L			Unit
				Min.	Typ.	Max.	
Output Voltage**	V_O		$T_J=25^\circ C$	8.60	9.00	9.40	V
		$I_O=1mA \sim 40mA$ $V_I=12V \sim 24V$		8.55	-	9.45	
		$I_O=1mA \sim 70mA$ $V_I=16V$		8.55	-	9.45	
Line Regulation	$\Delta V_{O(\Delta V_I)}$	$V_I=12V \sim 24V$	$T_J=25^\circ C$	-	45	175	mV
		$V_I=13V \sim 24V$		-	40	125	
Load Regulation	$\Delta V_{O(\Delta I_L)}$	$I_O=1mA \sim 100mA$	$T_J=25^\circ C$	-	19	90	mV
		$I_O=1mA \sim 40mA$		-	11	40	
Quiescent Current	I_{QC}		$T_J=25^\circ C$	-	4.1	6	mA
Quiescent Current Change	ΔI_{QC}	$V_I=13V \sim 24V$		-	-	1.5	mA
		$I_O=1mA \sim 40mA$		-	-	0.1	
Dropout Voltage	V_{DROP}		$T_J=25^\circ C$	-	1.7	-	V
Ripple Rejection	RR	$V_I=15V \sim 25V$, $f=120Hz$		38	45	-	dB

Electrical Characteristics

(Electrical Characteristics at $V_I=17V$, $I_O=40mA$, $C_I=0.33\mu F$, $C_O=0.1\mu F$, $0^\circ C \leq T_J \leq 125^\circ C$, Unless otherwise specified)

Parameter	Symbol	Test Condition*	S78L10L			Unit
			Min.	Typ.	Max.	
Output Voltage**	V_O	$T_J=25^\circ C$	9.6	10.0	10.4	V
		$I_O=1mA \sim 40mA$ $V_I=13V \sim 25V$	9.5	-	10.5	
		$I_O=1mA \sim 70mA$ $V_I=17V$	9.5	-	10.5	
Line Regulation	$\Delta V_{O(\Delta V_I)}$	$V_I=13V \sim 25V$	-	51	175	mV
		$V_I=14V \sim 25V$	-	42	125	
Load Regulation	$\Delta V_{O(\Delta I_L)}$	$I_O=1mA \sim 100mA$	-	20	90	mV
		$I_O=1mA \sim 40mA$	-	11	40	
Quiescent Current	I_{QC}	$T_J=25^\circ C$	-	4.2	6	mA
Quiescent Current Change	ΔI_{QC}	$V_I=14V \sim 25V$	-	-	1.5	mA
		$I_O=1mA \sim 40mA$	-	-	0.1	
Dropout Voltage	V_{DROP}	$T_J=25^\circ C$	-	1.7	-	V
Ripple Rejection	RR	$V_I=15V \sim 25V$, $f=120Hz$	37	44	-	dB

Electrical Characteristics

(Electrical Characteristics at $V_I=19V$, $I_O=40mA$, $C_I=0.33\mu F$, $C_O=0.1\mu F$, $0^\circ C \leq T_J \leq 125^\circ C$, Unless otherwise specified)

Parameter	Symbol	Test Condition*	S78L12L			Unit
			Min.	Typ.	Max.	
Output Voltage**	V_O	$T_J=25^\circ C$	11.5	12.0	12.5	V
		$I_O=1mA \sim 40mA$ $V_I=14V \sim 27V$	11.4	-	12.5	
		$I_O=1mA \sim 70mA$ $V_I=19V$	11.4	-	12.6	
Line Regulation	$\Delta V_{O(\Delta V_I)}$	$V_I=14.5V \sim 27V$	-	55	250	mV
		$V_I=16V \sim 27V$	-	49	200	
Load Regulation	$\Delta V_{O(\Delta I_L)}$	$I_O=1mA \sim 100mA$	-	22	100	mV
		$I_O=1mA \sim 40mA$	-	13	50	
Quiescent Current	I_{QC}	$T_J=25^\circ C$	-	4.3	6.5	mA
Quiescent Current Change	ΔI_{QC}	$V_I=16V \sim 27V$	-	-	1.5	mA
		$I_O=1mA \sim 40mA$	-	-	0.1	
Dropout Voltage	V_{DROP}	$T_J=25^\circ C$	-	1.7	-	V
Ripple Rejection	RR	$V_I=15V \sim 25V$, $f=120Hz$	37	42	-	dB

Electrical Characteristics

(Electrical Characteristics at $V_I=23V$, $I_O=40mA$, $C_I=0.33\mu F$, $C_O=0.1\mu F$, $0^\circ C \leq T_J \leq 125^\circ C$, Unless otherwise specified)

Parameter	Symbol	Test Condition*	S78L15L			Unit
			Min.	Typ.	Max.	
Output Voltage**	V_O	$T_J=25^\circ C$	14.40	15.0	15.60	V
		$I_O=1mA \sim 40mA$ $V_I=17.5V \sim 30V$	14.25	-	15.75	
		$I_O=1mA \sim 70mA$ $V_I=23V$	14.25	-	15.75	
Line Regulation	$\Delta V_{O(\Delta V_I)}$	$V_I=17.5V \sim 30V$	-	65	300	mV
		$V_I=19V \sim 30V$	-	58	250	
Load Regulation	$\Delta V_{O(\Delta I_L)}$	$I_O=1mA \sim 100mA$	-	25	150	mV
		$I_O=1mA \sim 40mA$	-	15	75	
Quiescent Current	I_{QC}	$T_J=25^\circ C$	-	4.6	6.5	mA
Quiescent Current Change	ΔI_{QC}	$V_I=19V \sim 30V$	-	-	1.5	mA
		$I_O=1mA \sim 40mA$	-	-	0.1	
Dropout Voltage	V_{DROP}	$T_J=25^\circ C$	-	1.7	-	V
Ripple Rejection	RR	$V_I=18.5V \sim 28.5V$, $f=120Hz$	34	39	-	dB

Electrical Characteristics

(Electrical Characteristics at $V_I=26V$, $I_O=40mA$, $C_I=0.33\mu F$, $C_O=0.1\mu F$, $0^\circ C \leq T_J \leq 125^\circ C$, Unless otherwise specified)

Parameter	Symbol	Test Condition*	S78L18L			Unit
			Min.	Typ.	Max.	
Output Voltage**	V_O	$T_J=25^\circ C$	17.3	18.0	18.7	V
		$I_O=1mA \sim 40mA$ $V_I=20.5V \sim 33V$	17.1	-	18.9	
		$I_O=1mA \sim 70mA$ $V_I=26V$	17.1	-	18.9	
Line Regulation	$\Delta V_{O(\Delta V_I)}$	$V_I=20.5V \sim 33V$	-	70	360	mV
		$V_I=22V \sim 33V$	-	64	300	
Load Regulation	$\Delta V_{O(\Delta I_L)}$	$I_O=1mA \sim 100mA$	-	27	180	mV
		$I_O=1mA \sim 40mA$	-	19	90	
Quiescent Current	I_{QC}	$T_J=25^\circ C$	-	4.7	6.5	mA
Quiescent Current Change	ΔI_{QC}	$V_I=22V \sim 33V$	-	-	1.5	mA
		$I_O=1mA \sim 40mA$	-	-	0.1	
Dropout Voltage	V_{DROP}	$T_J=25^\circ C$	-	1.7	-	V
Ripple Rejection	RR	$V_I=21.5V \sim 31.5V$, $f=120Hz$	32	36	-	dB

Electrical Characteristics

(Electrical Characteristics at $V_I=32V$, $I_O=40mA$, $C_I=0.33 \mu F$, $C_O=0.1 \mu F$, $0^\circ C \leq T_J \leq 125^\circ C$, Unless otherwise specified)

Parameter	Symbol	Test Condition*	S78L24L			Unit
			Min.	Typ.	Max.	
Output Voltage**	V_O	$T_J=25^\circ C$	23.0	24.0	25.0	V
		$I_O=1mA \sim 40mA$ $V_I=26.5V \sim 39V$	22.8	-	25.2	
		$I_O=1mA \sim 70mA$ $V_I=32V$	22.8	-	25.2	
Line Regulation	$\Delta V_{O(\Delta V_I)}$	$V_I=26.5V \sim 39V$	-	95	480	mV
		$V_I=29V \sim 39V$	-	78	400	
Load Regulation	$\Delta V_{O(\Delta I_L)}$	$I_O=1mA \sim 100mA$	-	41	240	mV
		$I_O=1mA \sim 40mA$	-	28	120	
Quiescent Current	I_{QC}	$T_J=25^\circ C$	-	4.8	6.5	mA
Quiescent Current Change	ΔI_{QC}	$V_I=28V \sim 39V$	-	-	1.5	mA
		$I_O=1mA \sim 40mA$	-	-	0.1	
Dropout Voltage	V_{DROP}	$T_J=25^\circ C$	-	1.7	-	V
Ripple Rejection	RR	$V_I=27.5V \sim 37.5V$, $f=120Hz$	30	33	-	dB

* Pulse testing techniques are used to maintain the junction temperature as close to the ambient temperature as possible.

Thermal effects must be taken into account separately. All characteristics are measured with a $0.33 \mu F$ capacitor across the input and a $0.1 \mu F$ capacitor across the output.

** This specification applies only for dc power dissipation permitted by absolute maximum ratings.

Electrical Characteristics Curve

Fig.1 V_O vs. T_J

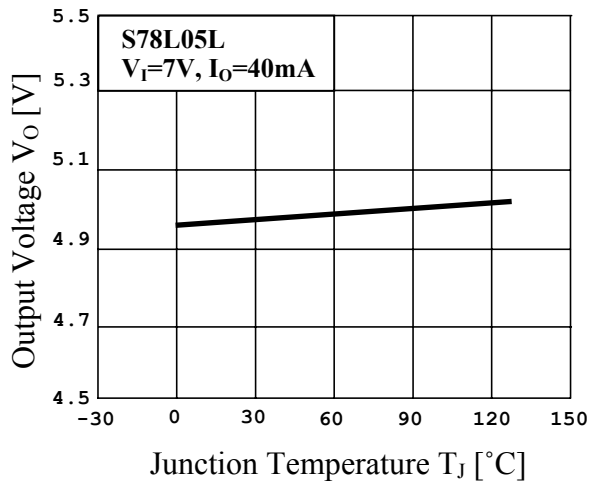

Fig.2 I_{QC} vs. T_J

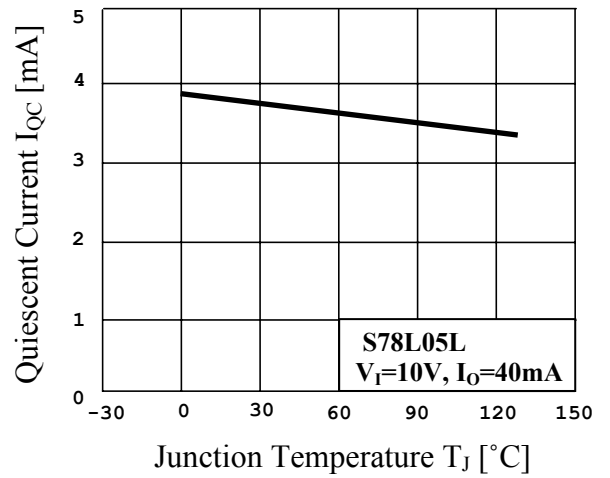

Fig.3 V_O vs. I_O

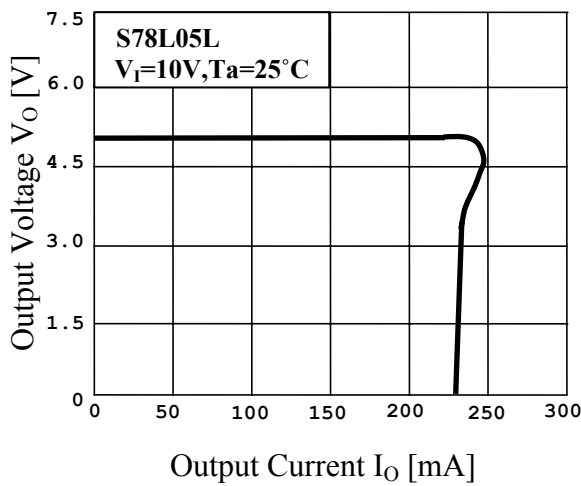

Fig.4 V_O vs. V_I

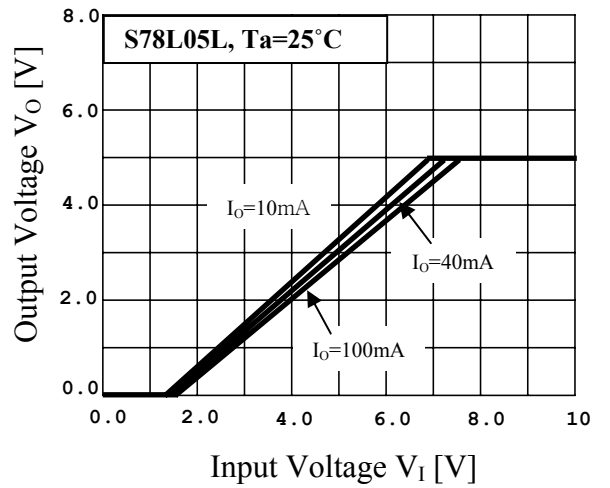

Fig.5 I_{QC} vs. V_I

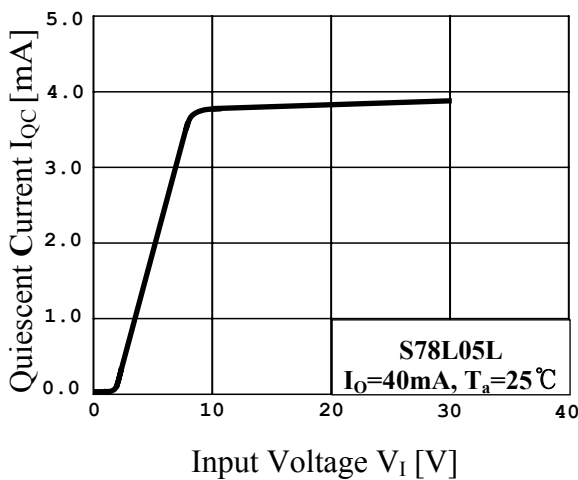
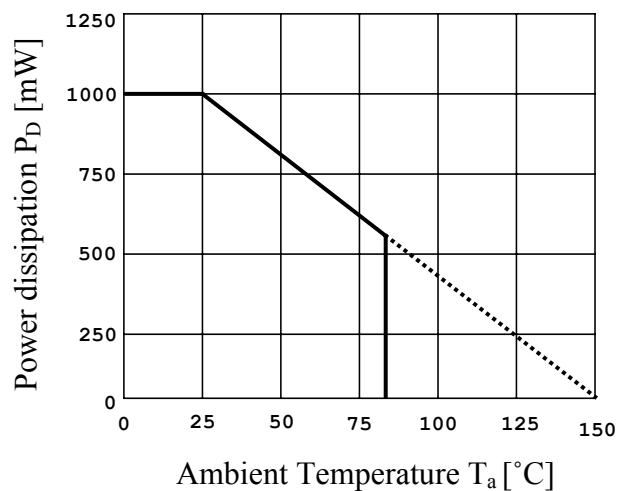

Fig.6 P_D vs. T_a



The AUK Corp. products are intended for the use as components in general electronic equipment (Office and communication equipment, measuring equipment, home appliance, etc.).

Please make sure that you consult with us before you use these AUK Corp. products in equipments which require high quality and / or reliability, and in equipments which could have major impact to the welfare of human life(atomic energy control, airplane, spaceship, transportation, combustion control, all types of safety device, etc.). AUK Corp. cannot accept liability to any damage which may occur in case these AUK Corp. products were used in the mentioned equipments without prior consultation with AUK Corp..

Specifications mentioned in this publication are subject to change without notice.