

January 1990
Edition 1.1



PRODUCT PROFILE

2SC2920, 2SC2429, 2SC2429A, 2SC2964, 2SC2965
Silicon High Speed Power Transistor

DESCRIPTION

This series are silicon NPN planer general purpose, high power switching transistors fabricated with Fujitsu's unique Ring Emitter Transistor (RET) technology. RET devices are constructed with multiple emitters connected through diffused ballast resistors which provide uniform current density. This structure permits the design of high power transistors with superior switching characteristics and frequency response in high current applications.

This series are especially well-suited for high speed/high voltage switching systems or other applications where large SOA is required.

Features

- ★ High voltage
- ★ Ultra-fast switching
- ★ Large safe operating area

Applications

- ★ Switching regulators
- ★ Motor controls
- ★ Ultrasonic oscillators
- ★ Class C and D amplifiers
- ★ Deflection circuits

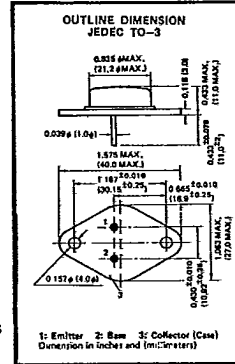

Outline of the Series (Ta = 25 °C)

Parts Number	V _{CEO} (V) Min.	t _{stg} (μs) Typ. at 10 A	t _f (μs) Typ. at 10 A	Operating Frequency Range of Switching Regulator
2SC2920	400	1.80 *1	0.18 *1	20 ~ 50 kHz
2SC2429	400			
2SC2429A	450	0.84 *2	0.10 *2	50 ~ 100 kHz
2SC2964	400			
2SC2965	450			100 ~ 200 kHz

* 1: I_{B1} = -I_{B2} = 1 A, *2: I_{B1} = -I_{B2} = 2 A

Maximum Ratings (Ta = 25 °C)

Item	Symbol	Test Condition	Ratings					Unit	
			2SC2920	2SC2429	2SC2429A	2SC2964	2SC2965		
Storage Temperature	T _{stg}		-65		~			+175	°C
Junction Temperature	T _j							+175	°C
Collector-Base Voltage	V _{CBO}		450		600			V	
Emitter-Base Voltage	V _{EBO}		7.0					V	
Collector-Emitter Voltage	V _{CEO}		400	450	400	450	V		
Collector Current-Continuous	I _C		15					A	
Collector Current-Pulsed	I _{CP}	P _w ≤ 10 mS D.R. ≤ 2 %	20					A	
Base Current-Continuous	I _B		5					A	
Collector Power Dissipation	P _C	T _c = 25 °C	150					W	

Copyright © 1990 by FUJITSU LIMITED and Fujitsu Microelectronics, Inc.

MAY 1982

2SC2920, 2SC2429, 2SC2429A, 2SC2964, 2SC2965

• Test Circuit used for Measurement of Switching Time (Resistive)

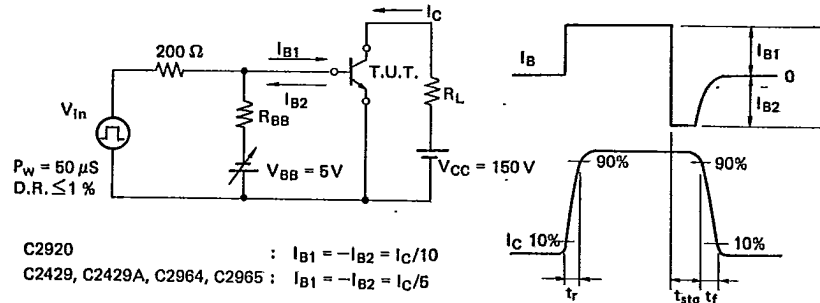

• Test Circuit used for Measurement of $V_{CEX(SUS)}$ and Reverse Bias Safe Operating Area

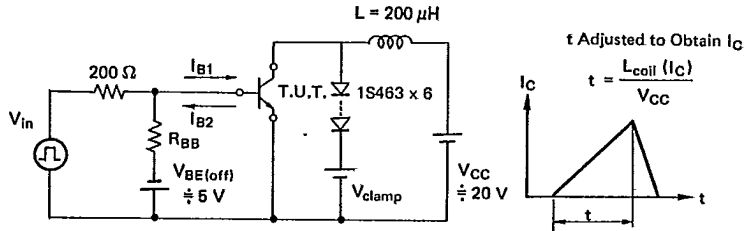

- Ⓐ $V_{CEX(SUS)}$
 $I_C = 8 A, I_{B1} = 2 A, I_{B2} = -1 A, R_{BB} = 5 \Omega, V_{clamp} = 450 V$
- Ⓑ Reverse Bias Safe Operating Area
 $I_{B1} \leq 4 A, I_{B2} = -1 A, R_{BB} = 5 \Omega$

January 1990
Edition 1.1

FUJITSU

T-33-13

PRODUCT PROFILE

2SC2920**Silicon High Speed Power Transistor**

ABSOLUTE MAXIMUM RATINGS (Ta = 25 °C)

Rating	Symbol	2SC2920	Unit
Collector to Emitter Voltage	V _{CEO}	400	V
Collector to Base Voltage	V _{CBO}	450	V
Emitter to Base Voltage	V _{EBO}	7	V
Collector Current-Continuous	I _C	15	A
Collector Current-Pulsed ($P_w \leq 10 \text{ mS}$, D.R. $\leq 2\%$)	I _{CP}	20	A
Base Current-Continuous	I _B	5	A
Collector Power Dissipation (T _C = 25 °C)	P _C	150	W
Junction Temperature	T _J	175	°C
Storage Temperature Range	T _{stg}	-65 ~ +175	°C

ELECTRICAL CHARACTERISTICS (Ta = 25 °C)

Parameters	Symbols	Test Conditions	Limits			Unit
			Min.	Typ.	Max.	
Collector to Base Breakdown Voltage	V _{(BR)CBO}	I _C = 100 μA, I _E = 0	450	-	-	V
Emitter to Base Breakdown Voltage	V _{(BR)EBO}	I _E = 1 mA, I _C = 0	7	-	-	V
Collector to Emitter Sustaining Voltage	V _{CEO(SUS)}	I _C = 1 A, R _{BE} = ∞ Ω	400	-	-	V
Collector to Emitter Sustaining Voltage	V _{CES(SUS)}	I _C = 8 A, I _{B2} = -1 A, L = 200 μH ^(*)	450	-	-	V
Collector Cutoff Current	I _{CBO}	V _{CB} = 450 V, I _E = 0	-	-	100	μA
Emitter Cutoff Current	I _{EBO}	V _{EB} = 6 V, I _C = 0	-	-	100	μA
DC Current Gain	h _{FE}	V _{CE} = 2 V, I _C = 10 A (*2)	10	13	30	-
Collector to Emitter Saturation Voltage	V _{CE(sat)}	I _C = 10 A, I _B = 1 A (*2)	-	0.56	1.0	V
Base to Emitter Saturation Voltage	V _{BE(sat)}		-	1.2	1.5	V
Output Capacitance	C _{ob}	V _{CB} = 10 V, I _E = 0, f = 1 MHz	-	240	-	PF
Gain Bandwidth Product	f _T	V _{CE} = 10 V, I _C = 2 A	-	30	-	MHz
Rise Time	t _r	V _{CC} = 150 V I _C = 10 A, I _{B1} = -I _{B2} = 1 A (*1)	-	0.20	0.5	μs
Storage Time	t _{stg}		-	1.80	3.0	μs
Fall Time	t _f		-	0.18	0.3	μs

*1 Test Circuit

*2 Pulsed P_w ≤ 300 μs, Duty Ratio ≤ 6 %

MARCH 1981

Copyright © 1990 by FUJITSU LIMITED and Fujitsu Microelectronics, Inc.

2SC2920

DC Current Gain

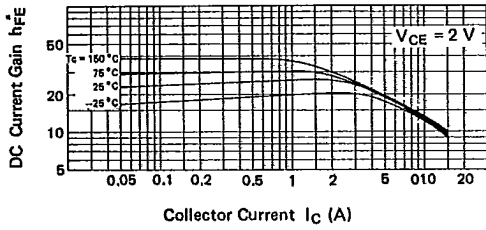

Switching Time

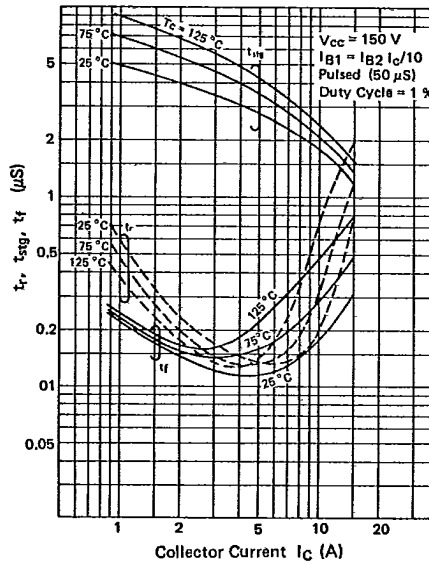

Gain Bandwidth Product

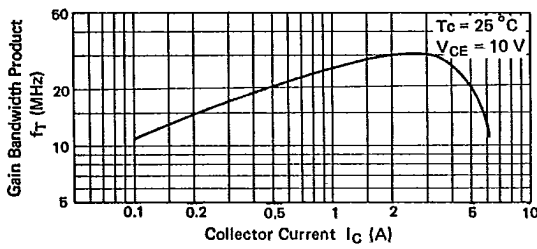

Reverse Bias Safe Operating Area

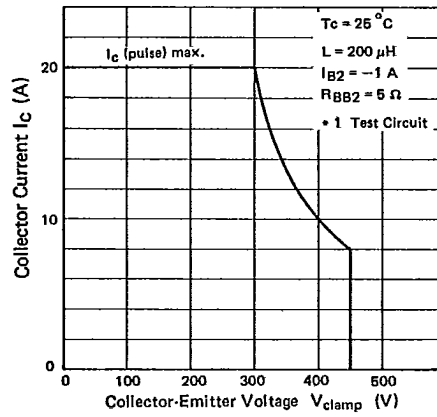

Output Capacitance

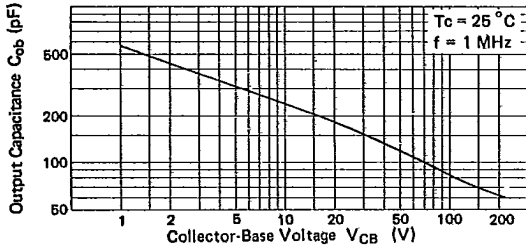

Switching Time

$V_{CC} = 150\text{ V}$
 $I_C = 10\text{ A}$
 Pulsed ($50\ \mu\text{s}$)
 Duty Ratio = 1 %

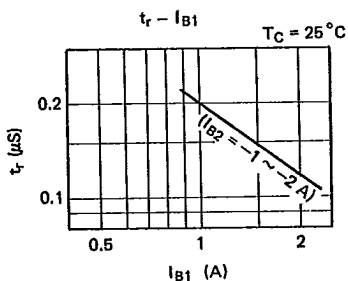
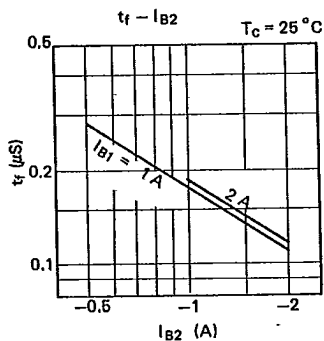
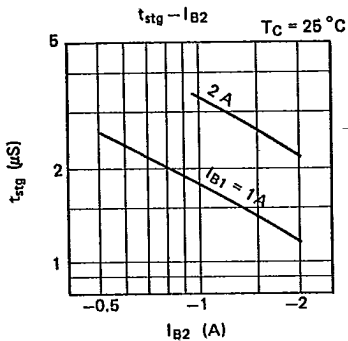

Saturation Voltage

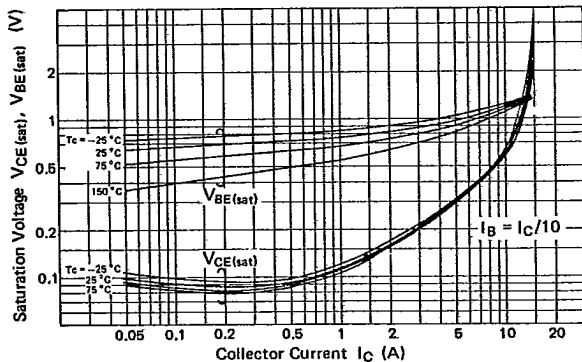

Collector Saturation Region

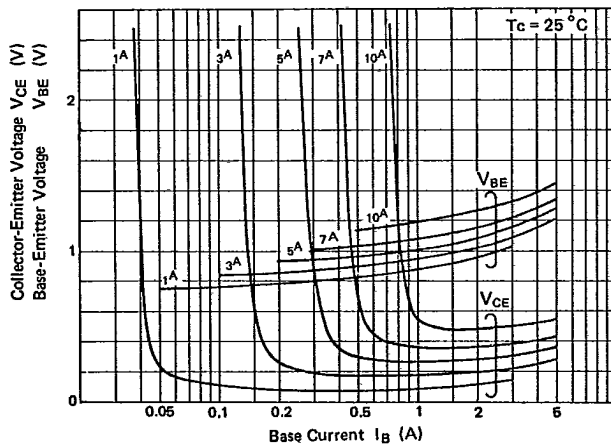

2SC2920

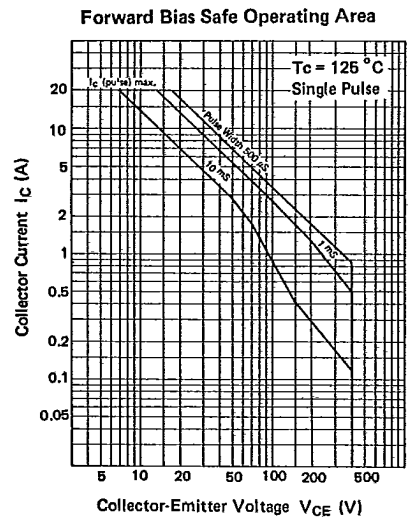
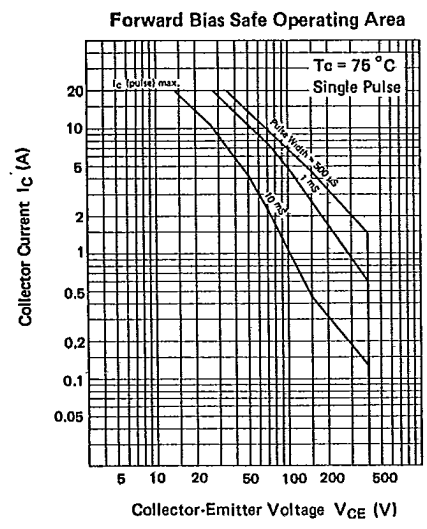
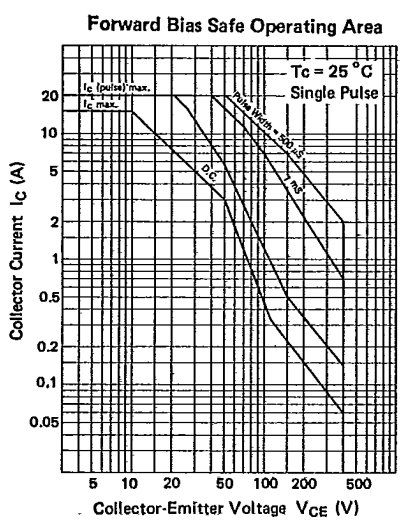
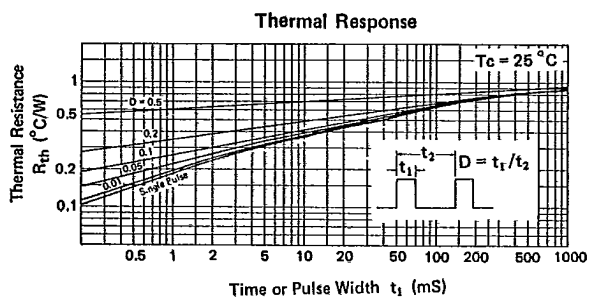

January 1990
Edition 1.1



PRODUCT PROFILE

2SC2429, 2SC2429A
Silicon High Speed Power Transistor

ABSOLUTE MAXIMUM RATINGS (Ta = 25 °C)

Rating	Symbol	2SC2429	2SC2429A	Unit
Collector to Emitter Voltage	V _{CEO}	400	450	V
Collector to Base Voltage	V _{CBO}	450	600	V
Emitter to Base Voltage	V _{EBO}	7	7	V
Collector Current-Continuous	I _C	15	15	A
Collector Current-Pulsed (P _w ≤ 10 mS, D.R. ≤ 2 %)	I _{CP}	20	20	A
Base Current-Continuous	I _B	5	5	A
Collector Power Dissipation (T _C = 25°)	P _C	150	150	W
Junction Temperature	T _J	175	175	°C
Storage Temperature Range	T _{stg}	-65 ~ +175	-65 ~ +175	°C



ELECTRICAL CHARACTERISTICS (Ta = 25 °C)

Parameters	Symbols	Test Conditions	Limits			Unit	
			Min.	Typ.	Max.		
Collector to Base Breakdown Voltage	V _{(BR)CBO}	2SC2429: I _C = 100 μA, I _E = 0	450	-	-	V	
		2SC2429A: I _C = 1 mA, I _E = 0	600	-	-	V	
Emitter to Base Breakdown Voltage	V _{(BR)EBO}	I _E = 1 mA, I _C = 0	7	-	-	V	
Collector Emitter Sustaining Voltage	V _{CEO(SUS)}	I _C = 1 A, R _{BE} = ∞Ω	2SC2429	400	-	-	V
			2SC2429A	450	-	-	V
Collector to Emitter Sustaining Voltage	V _{CES(SUS)}	I _C = 8 A, I _{B2} = -1 A, L = 200 μH (*1)	450	-	-	V	
Collector Cutoff Current	I _{CBO}	2SC2429: V _{CB} = 450 V, I _E = 0	-	-	100	μA	
		2SC2429A: V _{CB} = 500 V, I _E = 0	-	-	100	μA	
Emitter Cutoff Current	I _{EBO}	V _{EB} = 6 V, I _C = 0	-	-	100	μA	
DC Current Gain	h _{FE}	V _{CE} = 5 V, I _C = 10 A (*2)	10	15	40	-	
Collector to Emitter Saturation Voltage	V _{CE(sat)}	I _C = 10 A, I _B = 2 A (*2)	-	0.56	1.0	V	
Base to Emitter Saturation Voltage	V _{BE(sat)}		2SC2429	-	1.25	2.0	V
			2SC2429A	-	1.25	1.5	V
Output Capacitance	C _{ob}	V _{CB} = 10 V, I _E = 0, f = 1 MHz	-	240	-	PF	
Gain Bandwidth Product	f _T	V _{CE} = 10 V, I _C = 2 A	-	30	-	MHz	
Rise Time	t _r	V _{CC} = 150 V I _C = 10 A, I _{B1} = -I _{B2} = 2 A (*1)	-	0.13	0.5	μs	
Storage Time	t _{stg}		-	1.80	2.5	μs	
Fall Time	t _f		-	0.11	0.3	μs	

*1 Test Circuit

*2 Pulsed P_w ≤ 300 μs, Duty Ratio ≤ 6 %

MARCH 1981

2SC2429, 2SC2429A

DC Current Gain

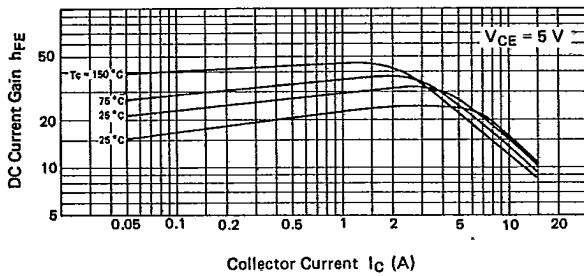

Switching Time

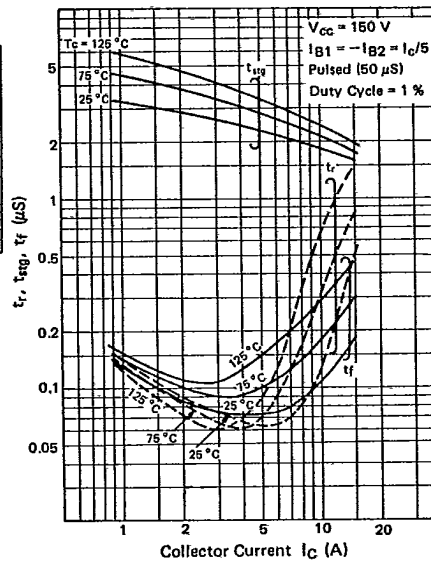

Gain Bandwidth Product

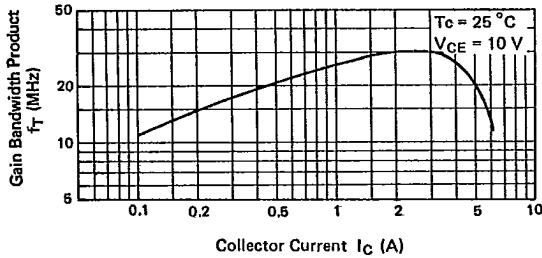

Reverse Bias Safe Operating Area

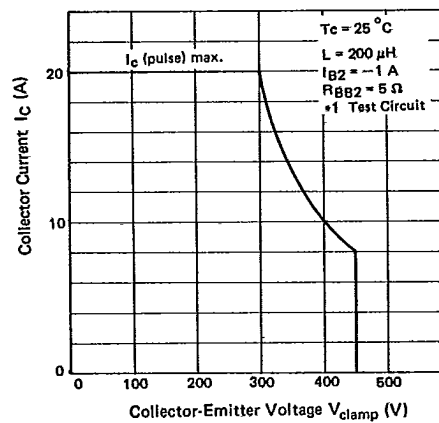

Output Capacitance

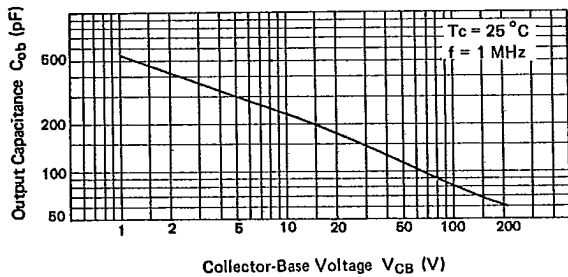

2SC2429, 2SC2429A

Switching Time

V_{CC} = 150 V
I_C = 10 A
Pulsed (50 μS)
Duty Ratio = 1 %

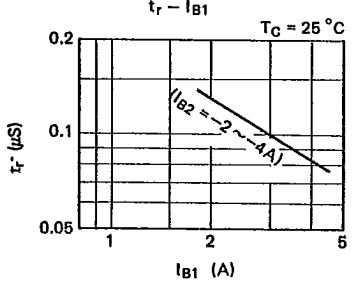
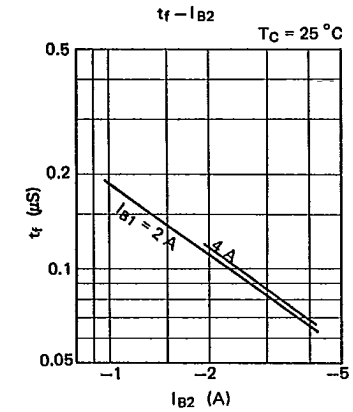
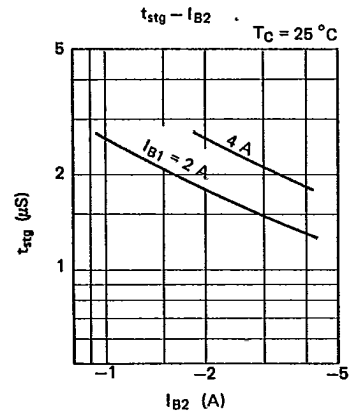

Saturation Voltage

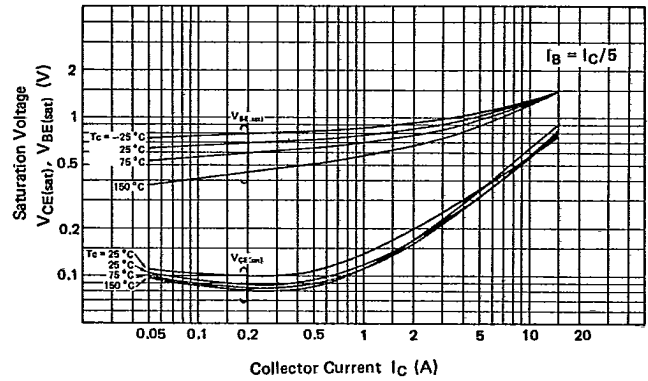

Collector Saturation Region

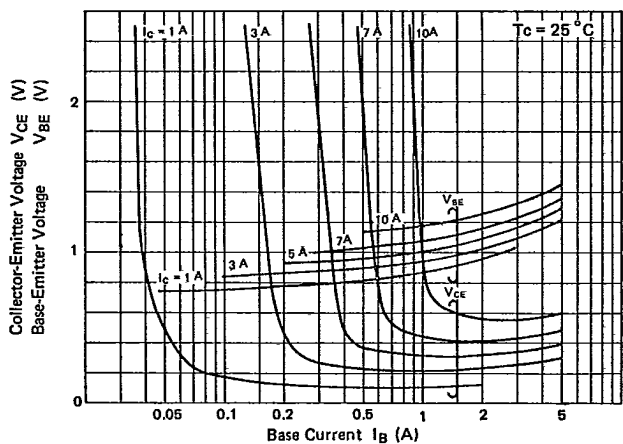

2SC2429, 2SC2429A

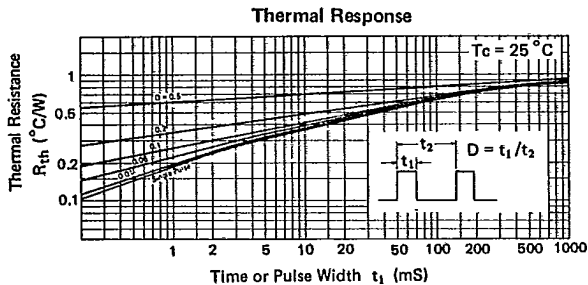

Forward Bias Safe Operating Area

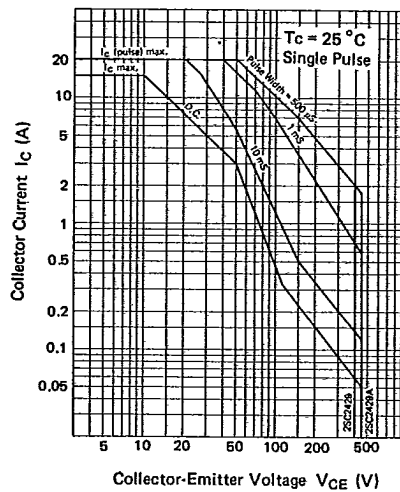

Forward Bias Safe Operating Area

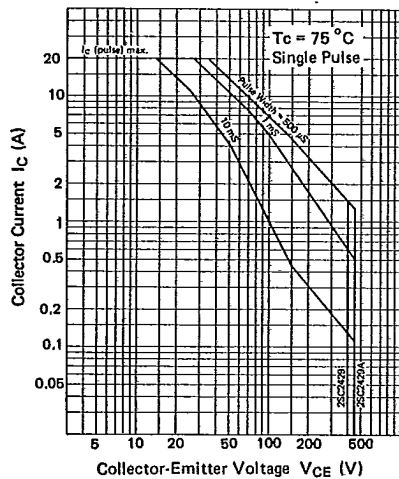

Forward Bias Safe Operating Area

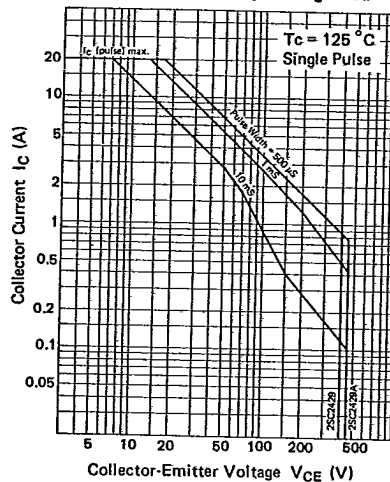

January 1990
Edition 1.1

FUJITSU

PRODUCT PROFILE

2SC2964, 2SC2965**Silicon High Speed Power Transistor**

ABSOLUTE MAXIMUM RATINGS (Ta = 25 °C)

Rating	Symbol	2SC2964	2SC2965	Unit
Collector to Emitter Voltage	V _{CE0}	400	450	V
Collector Base Voltage	V _{CBO}	600	600	V
Emitter to Base Voltage	V _{EBO}	7	7	V
Collector Current-Continuous	I _C	15	15	A
Collector Current-Pulsed ($P_w \leq 10 \text{ mS}$, D.R. $\leq 2\%$)	I _{CP}	20	20	A
Base Current-Continuous	I _B	5	5	A
Collector Power Dissipation (T _C = 25 °C)	P _C	150	150	W
Junction Temperature	T _J	175	175	°C
Storage Temperature Range	T _{stg}	-65 ~ +175	-65 ~ +175	°C

ELECTRICAL CHARACTERISTICS (Ta = 25 °C)

Parameters	Symbols	Test Conditions	Limits			Unit	
			Min.	Typ.	Max.		
Collector to Base Breakdown Voltage	V _{(BR)CBO}	I _C = 1 mA, I _E = 0	600	-	-	V	
Emitter to Base Breakdown Voltage	V _{(BR)EBO}	I _E = 1 mA, I _C = 0	7	-	-	V	
Collector to Emitter Sustaining Voltage	V _{CEO(SUS)}	I _C = 0.8 A, R _{BE} = ∞Ω	2SC2964	400	-	-	V
			2SC2965	450	-	-	V
Collector to Emitter Sustaining Voltage	V _{CEX(SUS)}	I _C = 8 A, I _{B2} = -1 A, L = 200 μH ^(*1)	450	-	-	V	
Collector Cutoff Current	I _{CBO}	V _{CB} = 500 V, I _E = 0	-	-	100	μA	
Emitter Cutoff Current	I _{EBO}	V _{EB} = 6 V, I _C = 0	-	-	100	μA	
DC Current Gain	h _{FE}	V _{CE} = 5 V, I _C = 10 A ^(*2)	7	8.5	20	-	
Collector to Emitter Saturation Voltage	V _{CE(sat)}	I _C = 10 A, I _B = 2 A ^(*2)	-	0.75	1.5	V	
Base to Emitter Saturation Voltage	V _{BE(sat)}		-	1.25	1.5	V	
Output Capacitance	C _{ob}	V _{CB} = 10 V, I _E = 0, f = 1 MHz	-	230	-	pF	
Gain Bandwidth Product	f _T	V _{CE} = 10 V, I _C = 2 A	-	28	-	MHz	
Rise Time	t _r	V _{CC} = 150 V I _C = 10 A, I _{B1} = -I _{B2} = 2 A ^(*1)	-	0.15	0.5	μs	
Storage Time	t _{stg}		-	0.84	1.0	μs	
Fall Time	t _f		-	0.10	0.3	μs	

*1 Test Circuit

*2 Pulsed P_w ≤ 300 μs, Duty Ratio ≤ 6%

Copyright © 1990 by FUJITSU LIMITED and Fujitsu Microelectronics, Inc.

2SC2964, 2SC2965

DC Current Gain

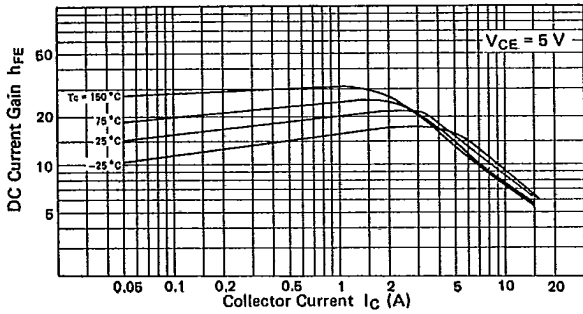

Switching Time

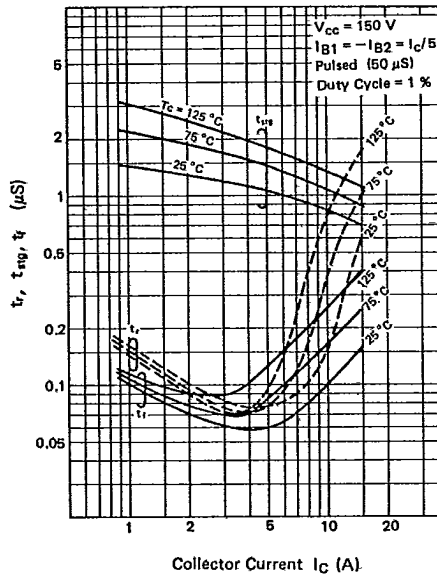

Gain Bandwidth Product

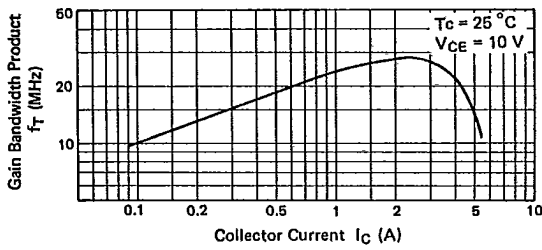

Reverse Bias Safe Operating Area

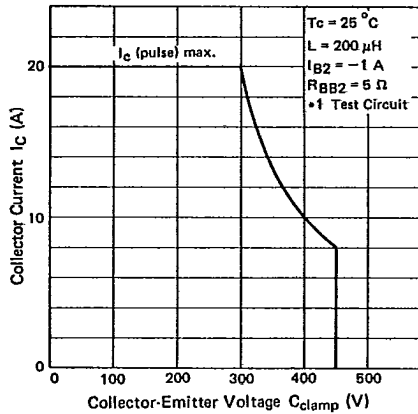

Output Capacitance

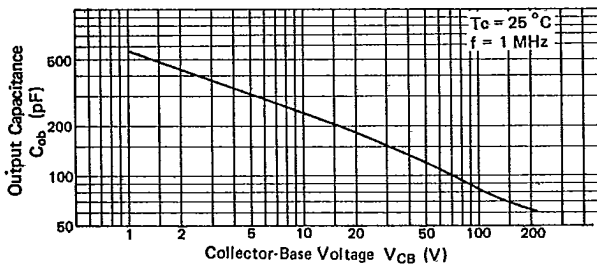

2SC2964, 2SC2965

Switching Time

$V_{CC} = 150\text{ V}$
 $I_C = 10\text{ A}$
 Pulsed ($50\text{ }\mu\text{s}$)
 Duty Ratio = 1 %

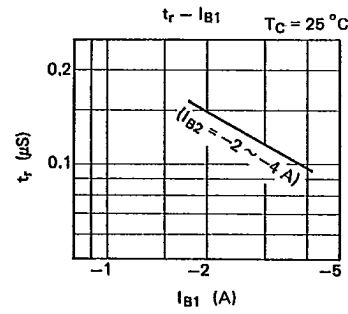
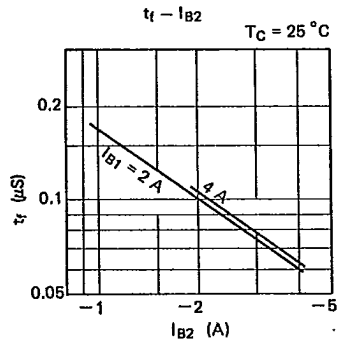
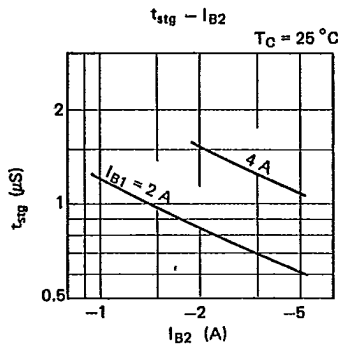

Saturation Voltage

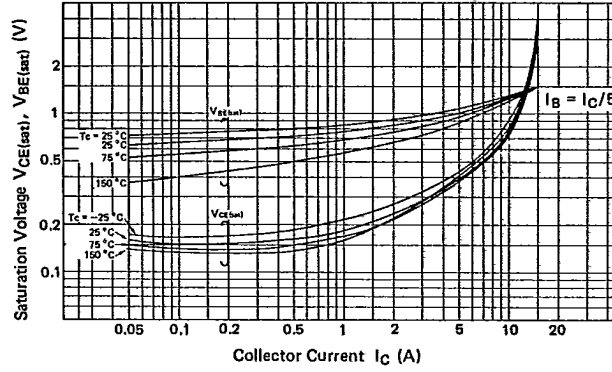

Collector Saturation Region

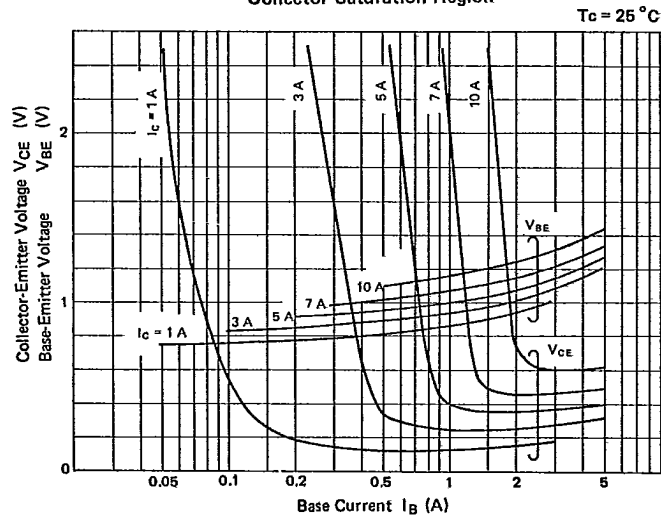

2SC2964, 2SC2965

