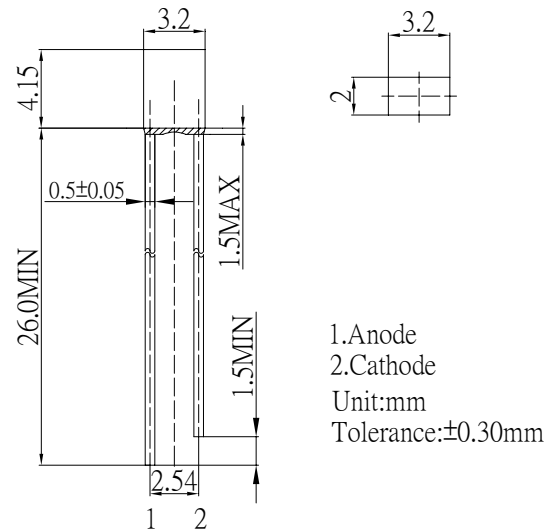

■Features

- High Luminous LEDs
- 2x3x4mm Rectangular Standard Directivity
- Long Lifetime Operation (Up to 100,000 hours)
- Superior Weather-resistance
- UV Resistant Epoxy
- Water Clear Type

■Applications

- Counterfeit Detection
- NDT Crack Detection
- Fluid Leak Detection
- Forensic Science/Infection Control
- Other Lighting

■Outline Dimension

■Absolute Maximum Rating

(Ta=25°C)

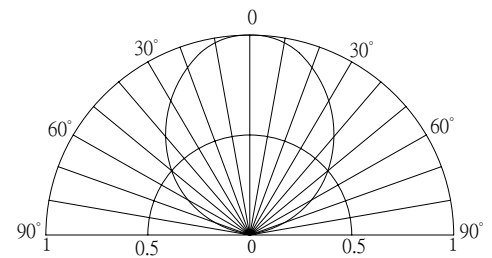
Item	Symbol	Value	Unit
DC Forward Current	I _F	30	mA
Pulse Forward Current*	I _{FP}	100	mA
Reverse Voltage	V _R	5	V
Power Dissipation	P _D	108	mW
Operating Temperature	T _{opr}	-30 ~ +85	°C
Storage Temperature	T _{stg}	-40 ~ +100	°C
Lead Soldering Temperature	T _{sol}	260°C/5sec	-

■Directivity

*Pulse width Max.10ms Duty ratio max 1/10

■Electrical -Optical Characteristics

(Ta=25°C)

Item	Symbol	Condition	Min.	Typ.	Max.	Unit
DC Forward Voltage	V _F	I _F =20mA	2.9	3.1	3.6	V
DC Reverse Current	I _R	V _R =5V	-	-	10	μA
Peak Wavelength*	λ _p	I _F =20mA	400	405	410	nm
Luminous Intensity*	I _v	I _F =20mA	5	10	-	mcd
50% Power Angle	2θ _{1/2}	I _F =20mA	-	100	-	deg

*1 Tolerance of Peak wavelength is ±1nm

*2 Tolerance of luminous intensity is ±15%

LED & Application Technologies
