

*Three level inverter
CoolMOS & Trench + Field Stop IGBT
Power Module*

Trench & Field Stop IGBT Q2, Q3:
 $V_{CES} = 600V$; $I_C = 75A$ @ $T_c = 80^\circ C$

CoolMOS™ Q1, Q4:
 $V_{DSS} = 600V$; $I_D = 38A$ @ $T_c = 80^\circ C$

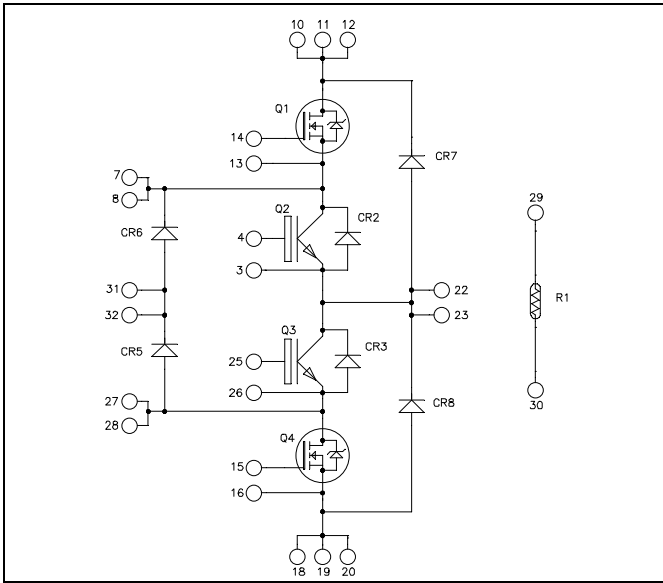

Application

- Solar converter
- Uninterruptible Power Supplies

Features

- **Q2, Q3 Trench + Field Stop IGBT Technology**
 - Low voltage drop
 - Low tail current
 - Switching frequency up to 20 kHz
 - Soft recovery parallel diodes
 - Low diode VF
 - Low leakage current
 - RBSOA and SCSOA rated
- **Q1, Q4 CoolMOS™**
 - Ultra low R_{DSon}
 - Low Miller capacitance
 - Ultra low gate charge
 - Avalanche energy rated
 - Very rugged
- Kelvin emitter for easy drive
- Very low stray inductance
- High level of integration
- Internal thermistor for temperature monitoring

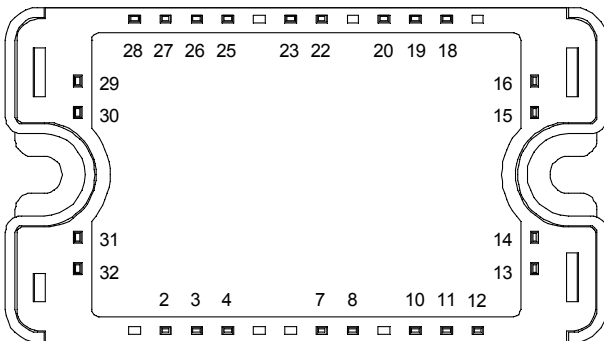

All multiple inputs and outputs must be shorted together
 Example: 10/11/12 ; 7/8 ...

Benefits

- Stable temperature behavior
- Very rugged
- Direct mounting to heatsink (isolated package)
- Low junction to case thermal resistance
- Easy paralleling due to positive TC of V_{CEsat}
- Low profile
- RoHS Compliant

All ratings @ $T_j = 25^\circ C$ unless otherwise specified

CAUTION: These Devices are sensitive to Electrostatic Discharge. Proper Handling Procedures Should Be Followed.
 See application note APT0502 on www.microsemi.com

Q1 & Q4 Absolute maximum ratings

<i>Symbol</i>	<i>Parameter</i>	<i>Max ratings</i>	<i>Unit</i>
V _{DSS}	Drain - Source Breakdown Voltage	600	V
I _D	Continuous Drain Current	T _c = 25°C	49
		T _c = 80°C	38
I _{DM}	Pulsed Drain current	130	A
V _{GS}	Gate - Source Voltage	±20	V
R _{DS(on)}	Drain - Source ON Resistance	45	mΩ
P _D	Maximum Power Dissipation	T _c = 25°C	250
I _{AR}	Avalanche current (repetitive and non repetitive)	15	A
E _{AR}	Repetitive Avalanche Energy	3	mJ
E _{AS}	Single Pulse Avalanche Energy	1900	

Q1 & Q4 Electrical Characteristics

<i>Symbol</i>	<i>Characteristic</i>	<i>Test Conditions</i>	<i>Min</i>	<i>Typ</i>	<i>Max</i>	<i>Unit</i>
I _{DSS}	Zero Gate Voltage Drain Current	V _{GS} = 0V, V _{DS} = 600V T _j = 25°C			250	μA
		V _{GS} = 0V, V _{DS} = 600V T _j = 125°C			500	
R _{DS(on)}	Drain – Source on Resistance	V _{GS} = 10V, I _D = 24.5A		40	45	mΩ
V _{GS(th)}	Gate Threshold Voltage	V _{GS} = V _{DS} , I _D = 3mA	2.1	3	3.9	V
I _{GSS}	Gate – Source Leakage Current	V _{GS} = ±20 V, V _{DS} = 0V			100	nA

Q1 & Q4 Dynamic Characteristics

<i>Symbol</i>	<i>Characteristic</i>	<i>Test Conditions</i>	<i>Min</i>	<i>Typ</i>	<i>Max</i>	<i>Unit</i>
C _{iss}	Input Capacitance	V _{GS} = 0V ; V _{DS} = 25V f = 1MHz		7.2		nF
C _{oss}	Output Capacitance			8.5		
Q _g	Total gate Charge	V _{GS} = 10V V _{Bus} = 300V I _D = 49A		150		nC
Q _{gs}	Gate – Source Charge			34		
Q _{gd}	Gate – Drain Charge			51		
T _{d(on)}	Turn-on Delay Time	Inductive Switching (125°C) V _{GS} = 10V V _{Bus} = 400V I _D = 49A R _G = 5Ω		21		ns
T _r	Rise Time			30		
T _{d(off)}	Turn-off Delay Time			100		
T _f	Fall Time			45		
E _{on}	Turn-on Switching Energy	Inductive switching @ 25°C V _{GS} = 10V ; V _{Bus} = 400V I _D = 49A ; R _G = 5Ω		675		μJ
E _{off}	Turn-off Switching Energy			520		
E _{on}	Turn-on Switching Energy	Inductive switching @ 125°C V _{GS} = 10V ; V _{Bus} = 400V I _D = 49A ; R _G = 5Ω		1100		μJ
E _{off}	Turn-off Switching Energy			635		
R _{thJC}	Junction to Case Thermal Resistance				0.5	°C/W

Q2 & Q3 Absolute maximum ratings

<i>Symbol</i>	<i>Parameter</i>		<i>Max ratings</i>	<i>Unit</i>
V _{CES}	Collector - Emitter Breakdown Voltage		600	V
I _C	Continuous Collector Current	T _C = 25°C	100	A
		T _C = 80°C	75	
I _{CM}	Pulsed Collector Current	T _C = 25°C	140	
V _{GE}	Gate - Emitter Voltage		±20	V
P _D	Maximum Power Dissipation	T _C = 25°C	250	W
RBSOA	Reverse Bias Safe Operating Area	T _J = 150°C	150A @ 550V	

Q2 & Q3 Electrical Characteristics

<i>Symbol</i>	<i>Characteristic</i>	<i>Test Conditions</i>	<i>Min</i>	<i>Typ</i>	<i>Max</i>	<i>Unit</i>
I _{CES}	Zero Gate Voltage Collector Current	V _{GE} = 0V, V _{CE} = 600V			250	μA
V _{CE(sat)}	Collector Emitter Saturation Voltage	V _{GE} = 15V I _C = 75A	T _J = 25°C	1.5	1.9	V
			T _J = 150°C	1.7		
V _{GE(th)}	Gate Threshold Voltage	V _{GE} = V _{CE} , I _C = 600μA	5.0	5.8	6.5	V
I _{GES}	Gate - Emitter Leakage Current	V _{GE} = 20V, V _{CE} = 0V			600	nA

Q2 & Q3 Dynamic Characteristics

<i>Symbol</i>	<i>Characteristic</i>	<i>Test Conditions</i>	<i>Min</i>	<i>Typ</i>	<i>Max</i>	<i>Unit</i>
C _{ies}	Input Capacitance	V _{GE} = 0V V _{CE} = 25V f = 1MHz		4620		pF
C _{oes}	Output Capacitance			300		
C _{res}	Reverse Transfer Capacitance			140		
Q _G	Gate charge	V _{GE} = ±15V, I _C = 75A V _{CE} = 300V		0.8		μC
T _{d(on)}	Turn-on Delay Time	Inductive Switching (25°C) V _{GE} = ±15V V _{Bus} = 300V I _C = 75A R _G = 4.7Ω		110		ns
T _r	Rise Time			45		
T _{d(off)}	Turn-off Delay Time			200		
T _f	Fall Time			40		
T _{d(on)}	Turn-on Delay Time	Inductive Switching (150°C) V _{GE} = ±15V V _{Bus} = 300V I _C = 75A R _G = 4.7Ω		120		ns
T _r	Rise Time			50		
T _{d(off)}	Turn-off Delay Time			250		
T _f	Fall Time			60		
E _{on}	Turn-on Switching Energy	V _{GE} = ±15V V _{Bus} = 300V I _C = 75A	T _J = 25°C	0.35		mJ
			T _J = 150°C	0.6		
E _{off}	Turn-off Switching Energy	R _G = 4.7Ω	T _J = 25°C	2.2		mJ
			T _J = 150°C	2.6		
I _{sc}	Short Circuit data	V _{GE} ≤ 15V ; V _{Bus} = 360V t _p ≤ 6μs ; T _J = 150°C		380		A
R _{thJC}	Junction to Case Thermal Resistance				0.60	°C/W

CR5 & CR6 diode ratings and characteristics

Symbol	Characteristic	Test Conditions		Min	Typ	Max	Unit
V _{RRM}	Maximum Peak Repetitive Reverse Voltage			600			V
I _{RM}	Maximum Reverse Leakage Current	V _R =600V	T _j = 25°C			25	μA
			T _j = 125°C			500	
I _F	DC Forward Current	T _c = 80°C			30		A
V _F	Diode Forward Voltage	I _F = 30A			1.8	2.2	V
		I _F = 60A			2.2		
		I _F = 30A	T _j = 125°C		1.5		
t _{rr}	Reverse Recovery Time	I _F = 30A V _R = 400V di/dt = 200A/μs	T _j = 25°C		25		ns
			T _j = 125°C		160		
Q _{rr}	Reverse Recovery Charge		T _j = 25°C		35		nC
			T _j = 125°C		480		
E _{rr}	Reverse Recovery Energy	I _F = 30A V _R = 400V di/dt = 1000A/μs	T _j = 125°C		0.6		mJ
R _{thJC}	Junction to Case Thermal Resistance					1.2	°C/W

CR2, CR3, CR7 & CR8 diode ratings and characteristics

Symbol	Characteristic	Test Conditions		Min	Typ	Max	Unit
V _{RRM}	Maximum Peak Repetitive Reverse Voltage			1200			V
I _{RM}	Maximum Reverse Leakage Current	V _R =1200V	T _j = 25°C			100	μA
			T _j = 125°C			500	
I _F	DC Forward Current	T _c = 80°C			30		A
V _F	Diode Forward Voltage	I _F = 30A			2.6	3.1	V
		I _F = 60A			3.2		
		I _F = 30A	T _j = 125°C		1.8		
t _{rr}	Reverse Recovery Time	I _F = 30A V _R = 800V di/dt = 200A/μs	T _j = 25°C		300		ns
			T _j = 125°C		380		
Q _{rr}	Reverse Recovery Charge		T _j = 25°C		360		nC
			T _j = 125°C		1700		
E _{rr}	Reverse Recovery Energy	I _F = 30A V _R = 800V di/dt = 1000A/μs	T _j = 125°C		1.6		mJ
R _{thJC}	Junction to Case Thermal Resistance					1.2	°C/W

Temperature sensor NTC (see application note APT0406 on www.microsemi.com for more information).

Symbol	Characteristic	Min	Typ	Max	Unit
R ₂₅	Resistance @ 25°C		50		kΩ
ΔR ₂₅ /R ₂₅			5		%
B _{25/85}	T ₂₅ = 298.15 K		3952		K
ΔB/B	T _C =100°C		4		%

$$R_T = \frac{R_{25}}{\exp\left[B_{25/85}\left(\frac{1}{T_{25}} - \frac{1}{T}\right)\right]}$$

T: Thermistor temperature
 R_T: Thermistor value at T

Thermal and package characteristics

Symbol	Characteristic	Min	Typ	Max	Unit	
V_{ISOL}	RMS Isolation Voltage, any terminal to case $t=1$ min, $I_{isol}<1$ mA, 50/60Hz	2500			V	
T_J	Operating junction temperature range	-40		175*	°C	
T_{STG}	Storage Temperature Range	-40		125		
T_C	Operating Case Temperature	-40		100		
Torque	Mounting torque	To heatsink	M4	2.5	4.7	N.m
Wt	Package Weight				110	g

* $T_{jmax} = 150^{\circ}\text{C}$ for Q1 & Q4

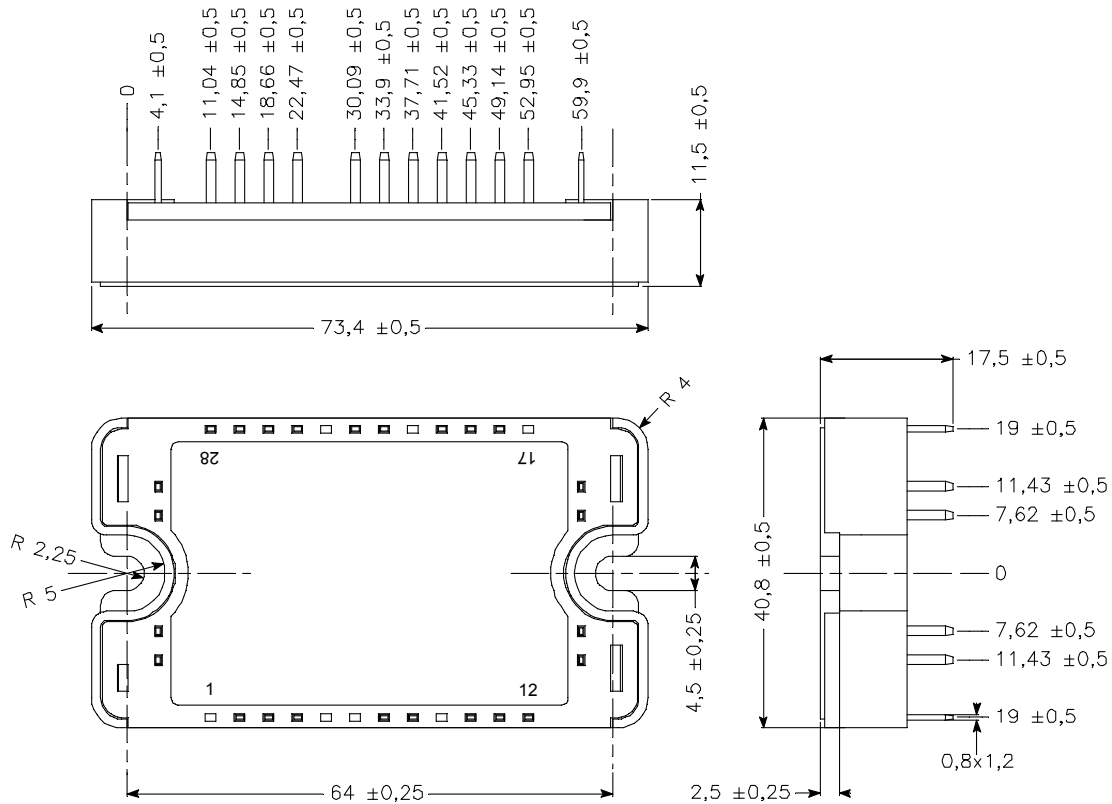
SP3 Package outline (dimensions in mm)

See application note 1901 - Mounting Instructions for SP3 Power Modules on www.microsemi.com

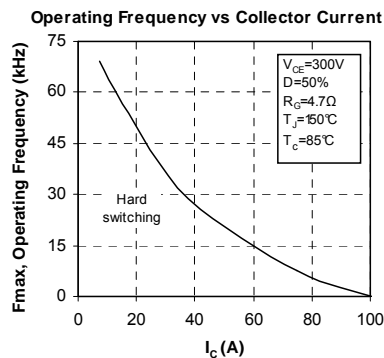
Q2 & Q3 Typical performance curve

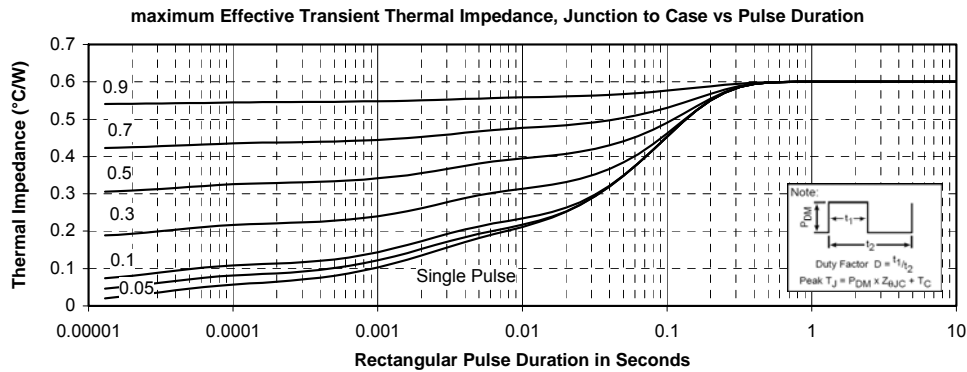
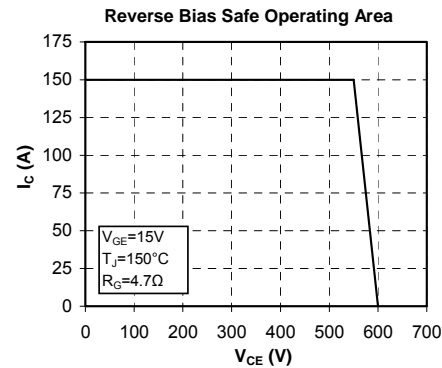
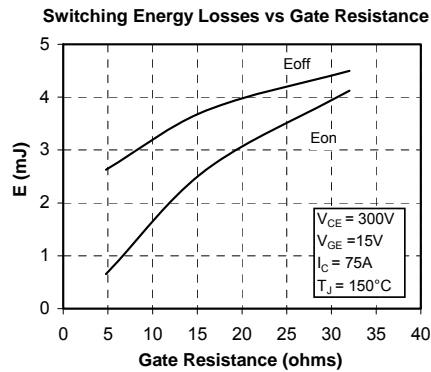
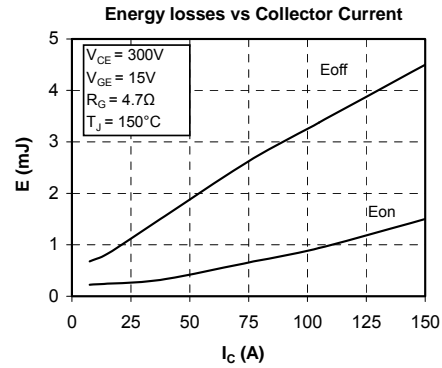
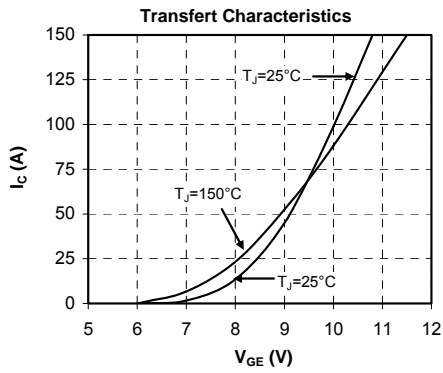
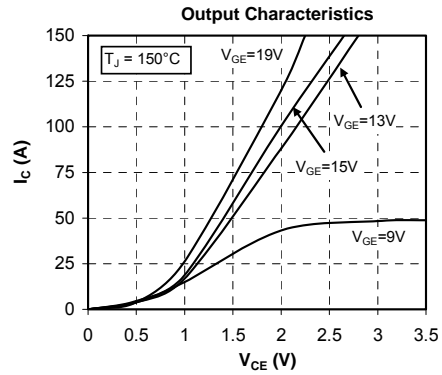
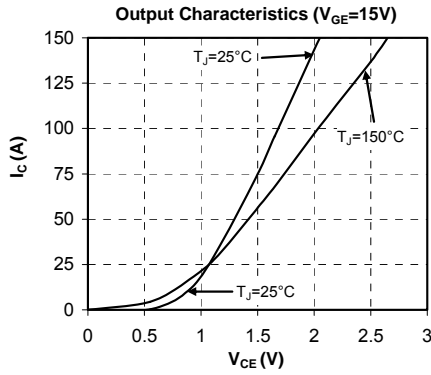

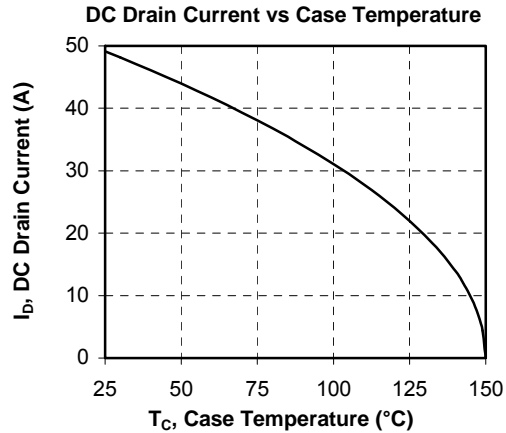
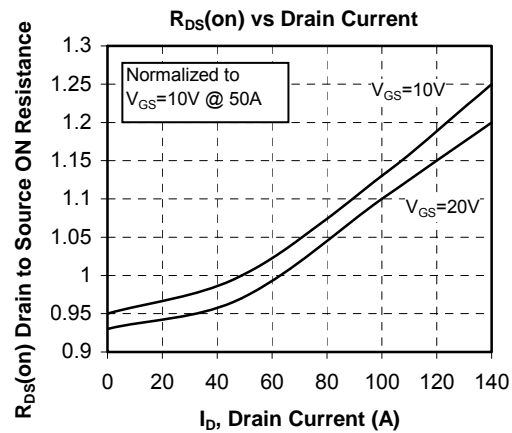
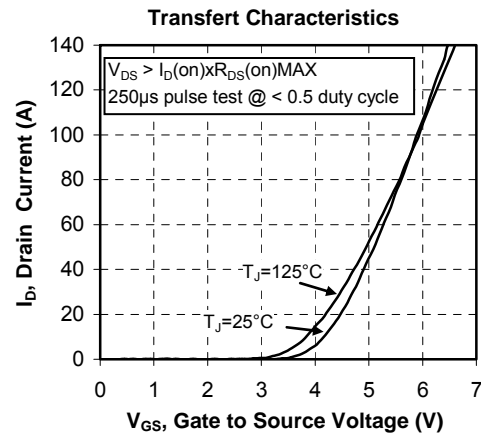
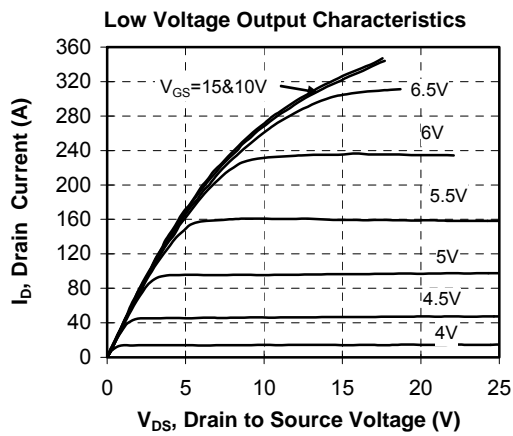
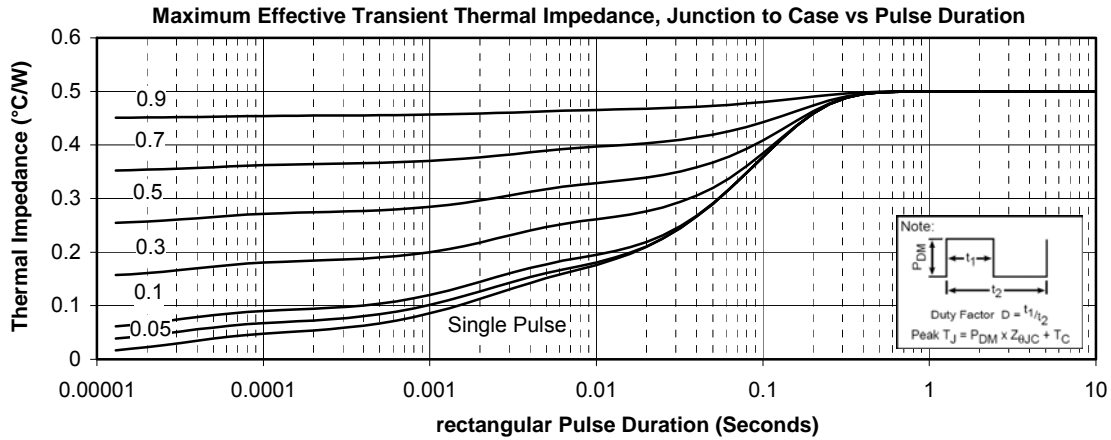
Q1 & Q4 Typical performance curve

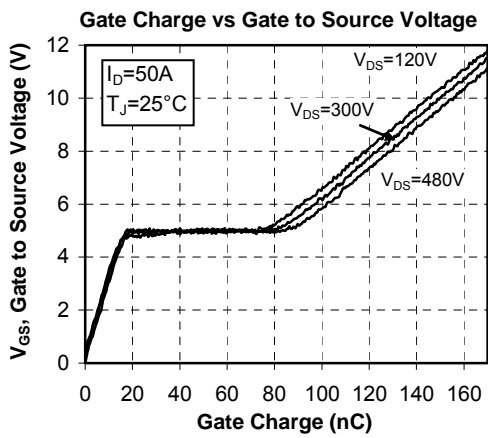
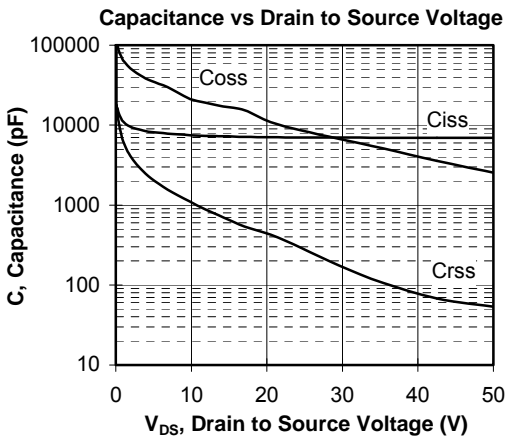
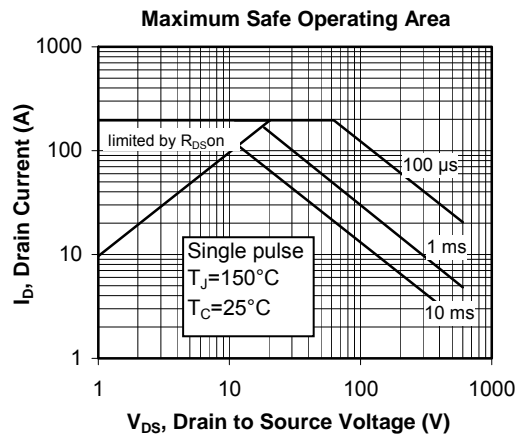
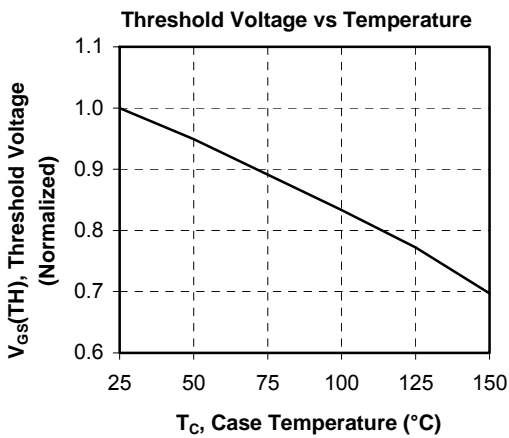
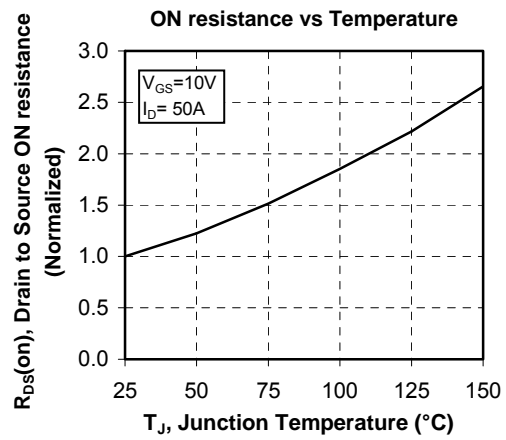
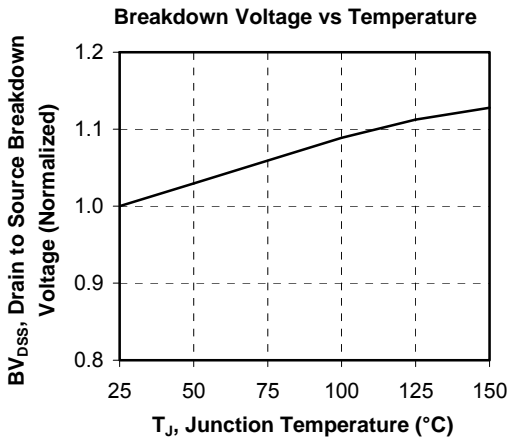

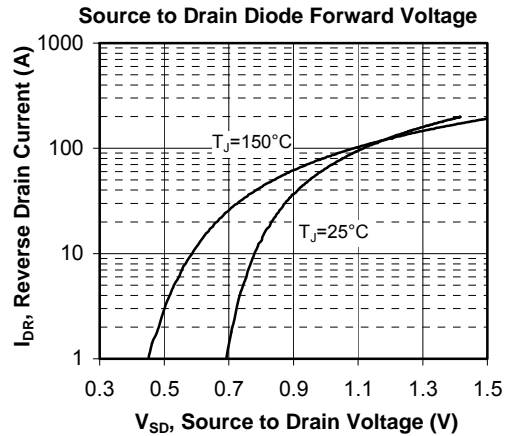
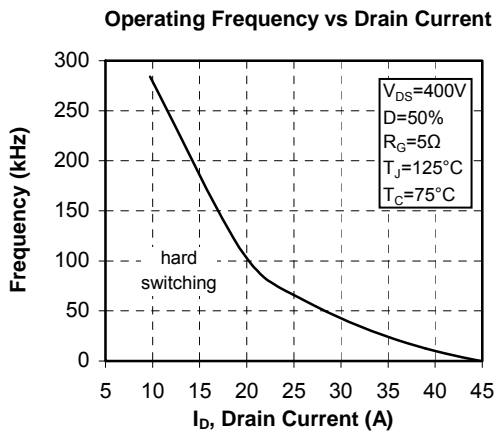
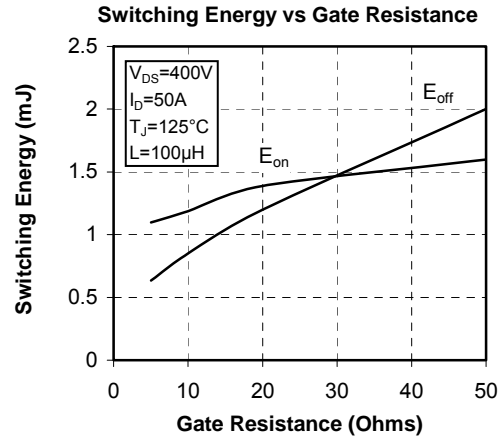
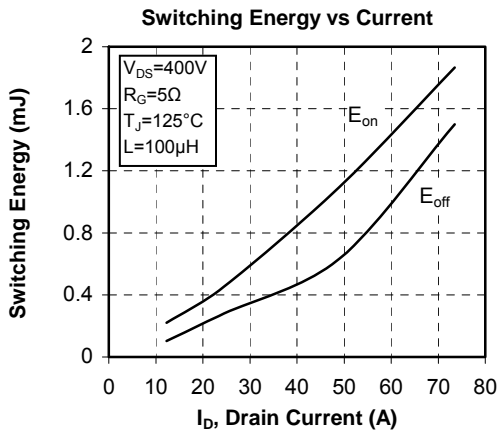
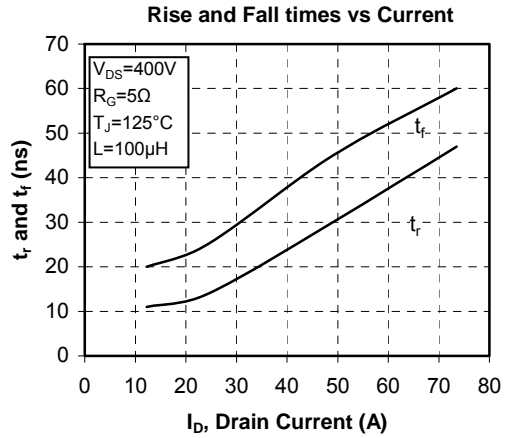
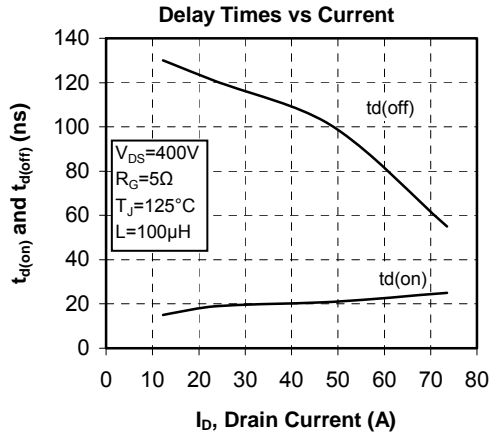

CR5 & CR6 Typical performance curve

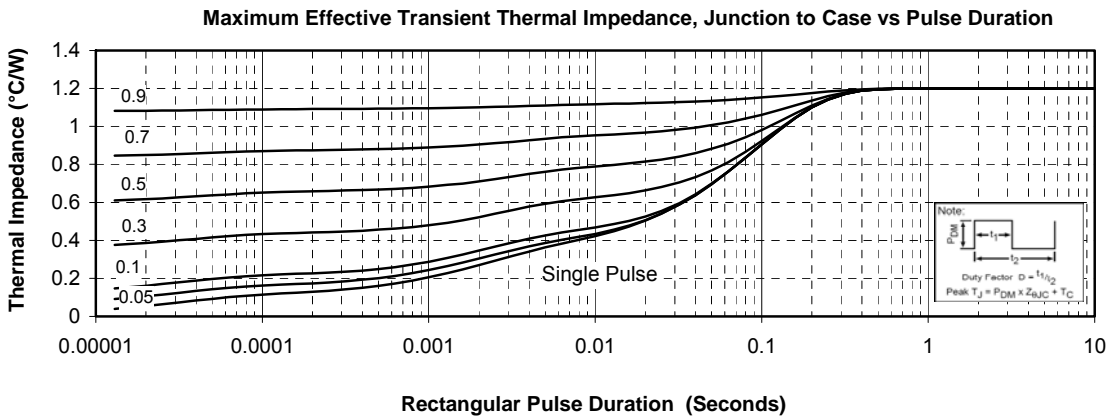
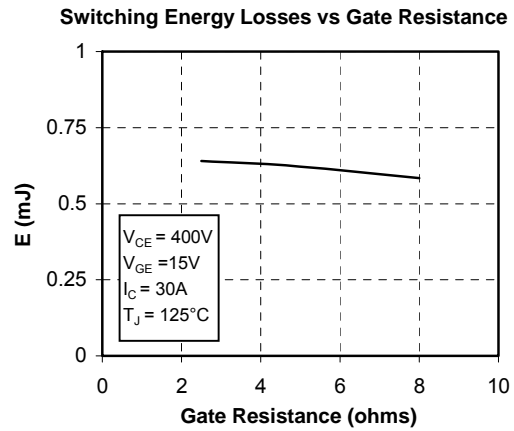
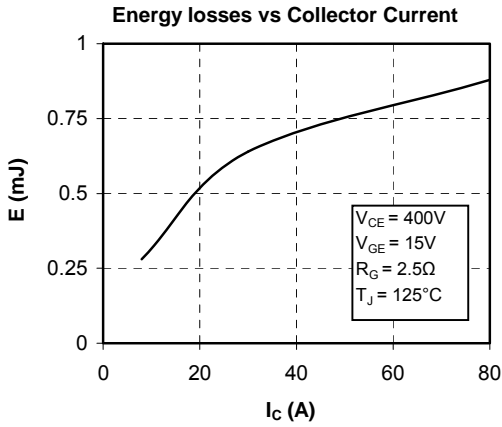
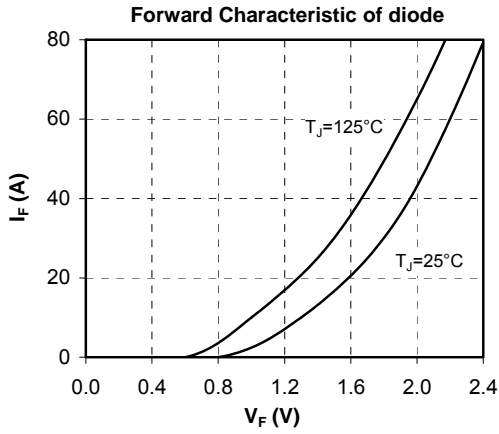

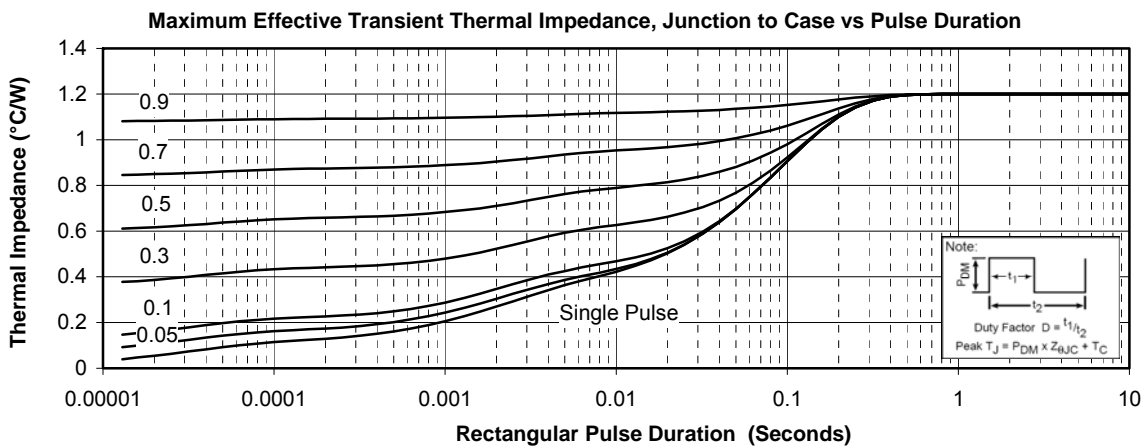
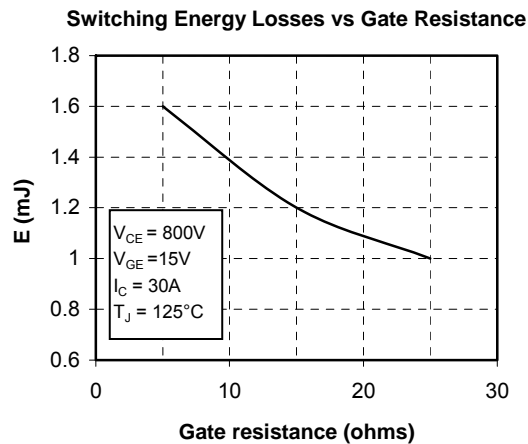
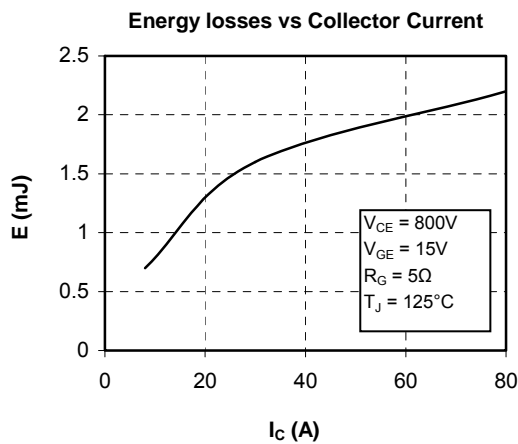
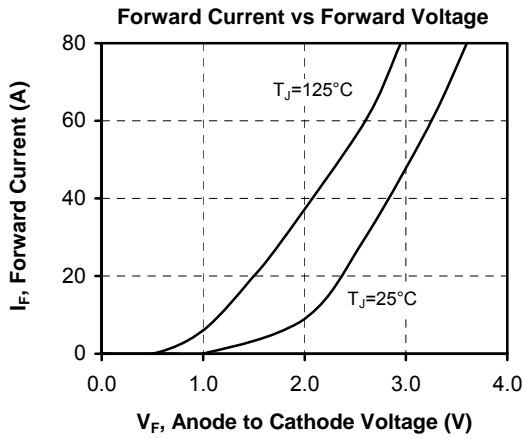
CR2, CR3, CR7 & CR8 Typical performance curve

Microsemi reserves the right to change, without notice, the specifications and information contained herein

Microsemi's products are covered by one or more of U.S. patents 4,895,810 5,045,903 5,089,434 5,182,234 5,019,522 5,262,336 6,503,786 5,256,583 4,748,103 5,283,202 5,231,474 5,434,095 5,528,058 6,939,743 7,352,045 5,283,201 5,801,417 5,648,283 7,196,634 6,664,594 7,157,886 6,939,743 7,342,262 and foreign patents. U.S and Foreign patents pending. All Rights Reserved.