

# FAN431/FAN431A/FAN431L

## Programmable Shunt Regulator

### Features

- Programmable Output Voltage to 36 Volts
- Low Dynamic Output Impedance 0.20 Typical
- Sink Current Capability of 1.0 to 100mA
- Equivalent Full-Range Temperature Coefficient of 50ppm/°C Typical
- Temperature Compensated for Operation Over Full Rated Operating Temperature Range
- Low Output Noise Voltage
- Fast Turn-on Response

### Description

The FAN431/FAN431A/FAN431L are three terminal output adjustable regulators with thermal stability over operating temperature range. The output voltage can be set any value between VREF (approximately 2.5 volts) and 36 volts with two external resistors. These devices have a typical dynamic output impedance of 0.2Ω Active output circuit provides a sharp turn-on characteristic, making these devices excellent replacement for Zener Diodes in many applications

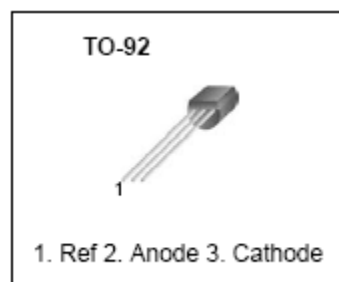

### Internal Block Diagram

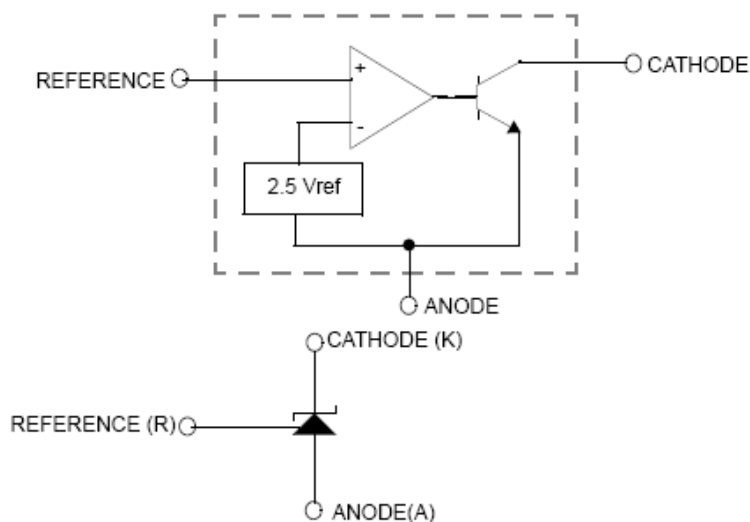

## Absolute Maximum Ratings

(Operating temperature range applies unless otherwise specified.)

Parameter	Symbol	Value	Unit
Cathode Voltage	VKA	37	V
Cathode current Range (Continuous)	IKA	-100 ~ +150	mA
Reference Input Current Range	IREF	-0.05 ~ +10	mA
Thermal Resistance Junction-Air (Note1,2) Z Suffix Package	R <sub>θJA</sub>	132	°C/W
Power Dissipation (Note3,4) Z Suffix Package	P <sub>D</sub>	940	mW
Junction Temperature	T <sub>J</sub>	150	°C
Operating Temperature Range	T <sub>OPR</sub>	-25 ~ +85	°C
Storage Temperature Range	T <sub>STG</sub>	-65 ~ +150	°C

### Note:

1. Thermal resistance test board  
Size: 76.2mm \* 114.3mm \* 1.6mm (1S0P)  
JEDEC Standard: JESD51-3, JESD51-7
2. Assume no ambient airflow.
3. T<sub>JMAX</sub> = 150°C, Ratings apply to ambient temperature at 25°C
4. Power dissipation calculation:  $P_D = (T_J - T_A)/R_{\theta JA}$

## Recommended Operating Conditions

Parameter	Symbol	Min.	Typ.	Max.	Unit
Cathode Voltage	VKA	VREF	-	36	V
Cathode Current	IKA	1.0	-	100	mA

## Electrical Characteristics

(TA = +25°C, unless otherwise specified)

Parameter	Symbol	Conditions	FAN431			FAN431A			FAN431L			Unit	
			Min.	Typ.	Max.	Min.	Typ.	Max.	Min.	Typ.	Max.		
Reference Input Voltage	VREF	VKA=VREF, IKA=10mA	2.450	2.500	2.550	2.470	2.495	2.520	2.482	2.495	2.508	V	
Deviation of Reference Input Voltage Over-Temperature	$\Delta V_{REF}/\Delta T$	VKA=VREF, IKA=10mA TMIN≤TA≤TMAX	-	4.5	17.0	-	4.5	17.0	-	4.5	17.0	mV	
Ratio of Change in Reference Input Voltage to the Change in Cathode Voltage	$\Delta V_{REF}/\Delta V_{KA}$	IKA=10mA	$\Delta V_{KA}=10V-V_{REF}$	-	-1.0	-2.7	-	-1.0	-2.7	-	-1.0	-2.7	mV/V
			$\Delta V_{KA}=36V-10V$	-	-0.5	-2.0	-	-0.5	-2.0	-	-0.5	-2.0	
Reference Input Current	IREF	IKA=10mA, R1=10kΩ,R2=∞	-	1.5	4.0	-	1.5	4.0	-	1.5	4.0	μA	
Deviation of Reference Input Current Over Full Temperature Range	$\Delta I_{REF}/\Delta T$	IKA=10mA, R1=10kΩ,R2=∞, TA=Full Range	-	0.4	1.2	-	0.4	1.2	-	0.4	1.2	μA	
Minimum Cathode Current for Regulation	IKA(MIN)	VKA=VREF	-	0.45	1.0	-	0.45	1.0	-	0.45	1.0	mA	
Off -Stage Cathode Current	IKA(OFF)	VKA=36V, VREF=0	-	0.05	1.0	-	0.05	1.0	-	0.05	1.0	μA	
Dynamic Impedance	ZKA	VKA=VREF, IKA=1 to 100mA, f ≥1.0kHz	-	0.15	0.5	-	0.15	0.5	-	0.15	0.5	Ω	

### Note1

TMIN = -25°C, TMAX = +85°C

## Test Circuits

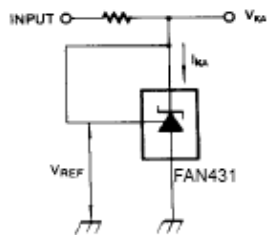

Figure 1. Test Circuit for  $V_{KA}=V_{REF}$

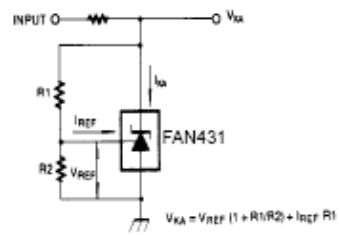

Figure 2. Test Circuit for  $V_{KA} \geq V_{REF}$

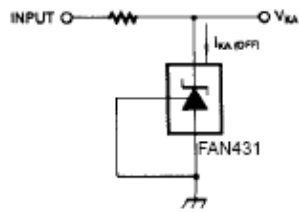

Figure 3. Test Circuit for  $I_{KA(OFF)}$

# Typical Performance Characteristics

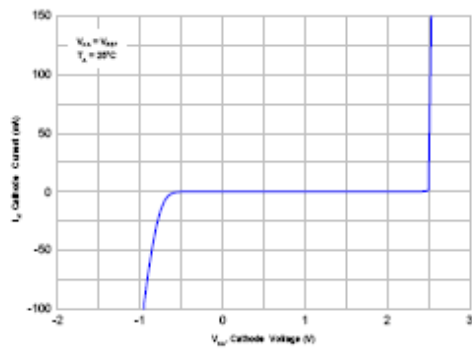

Figure 4. Cathode Current vs. Cathode Voltage

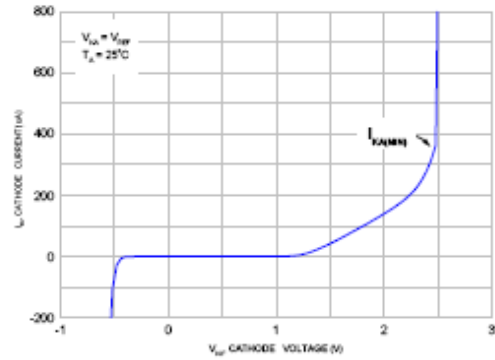

Figure 5. Cathode Current vs. Cathode Voltage

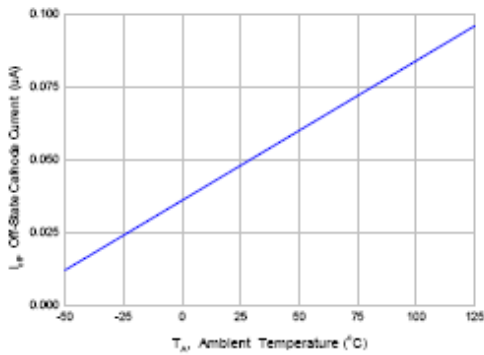

Figure 6. OFF-State Cathode Current vs. Ambient Temperature

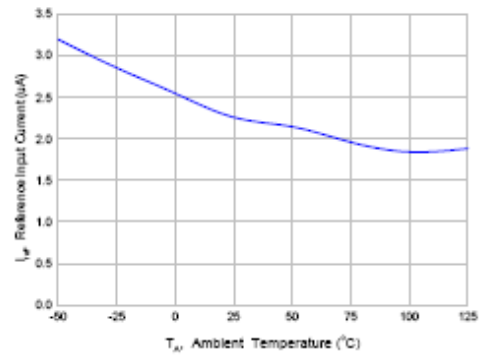

Figure 7. Reference Input Current vs. Ambient Temperature

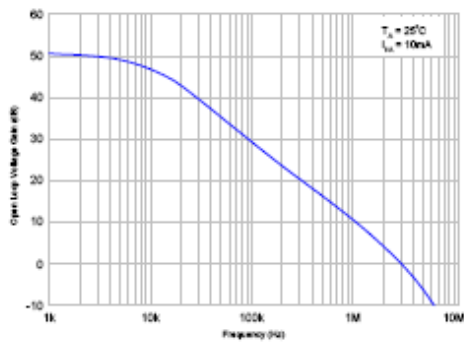

Figure 8. Small Signal Voltage Amplification vs. Frequency

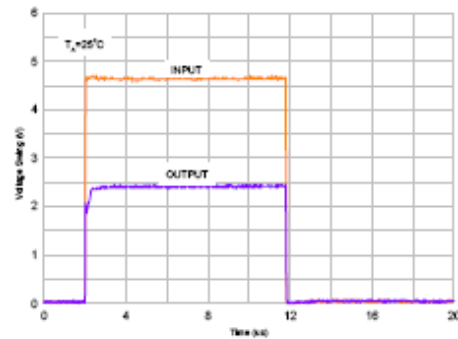

Figure 9. Pulse Response

# Typical Performance Characteristics (Continued)

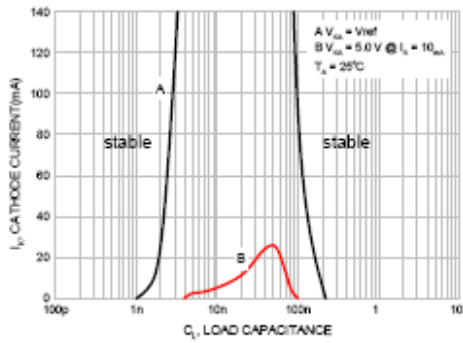

Figure 10. Stability Boundary Conditions

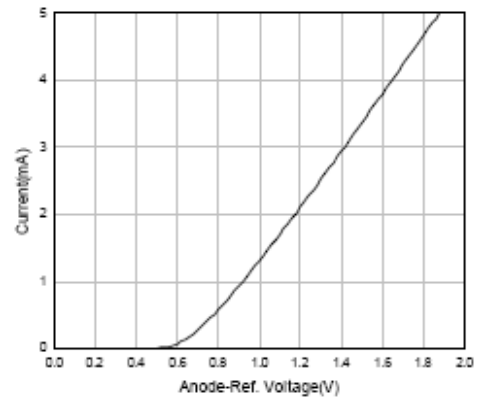

Figure 11. Anode-Reference Diode Curve

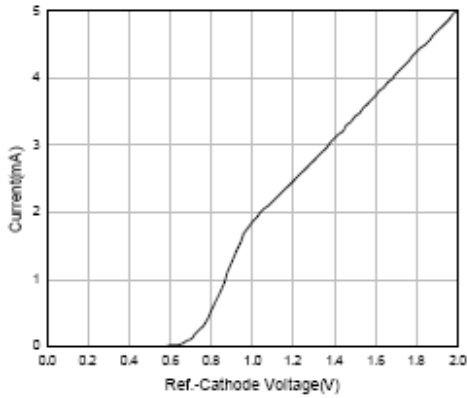

Figure 12. Reference-Cathode Diode Curve

## Typical Application

$$V_O = \left(1 + \frac{R_1}{R_2}\right) V_{ref}$$

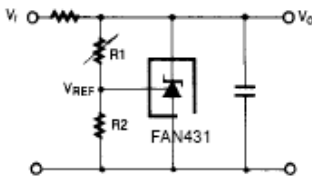

Figure 13. Shunt Regulator

$$V_O = V_{ref} \left(1 + \frac{R_1}{R_2}\right)$$

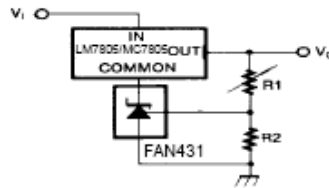

Figure 14. Output Control for Three-Terminal Fixed Regulator

$$V_O = \left(1 + \frac{R_1}{R_2}\right) V_{ref}$$

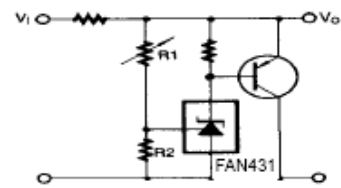

Figure 15. High Current Shunt Regulator

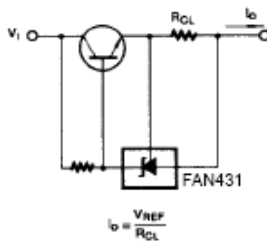

Figure 16. Current Limit or Current Source

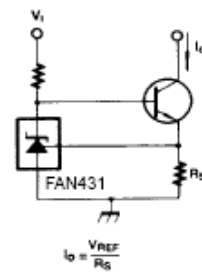

Figure 17. Constant-Current Sink

# Mechanical Dimensions

Package

Dimensions in millimeters

## TO-92 Bulk Type

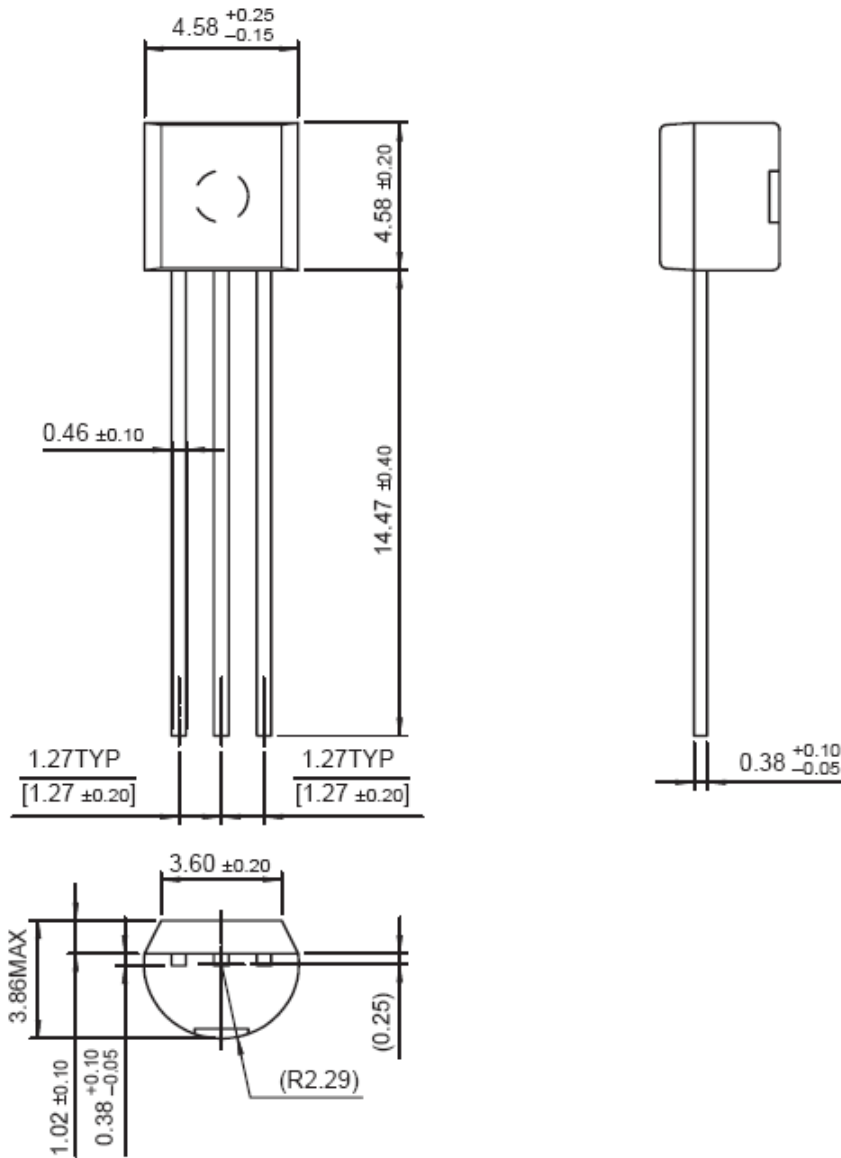



# TO-92 Ammo Type & Tape And Reel Type

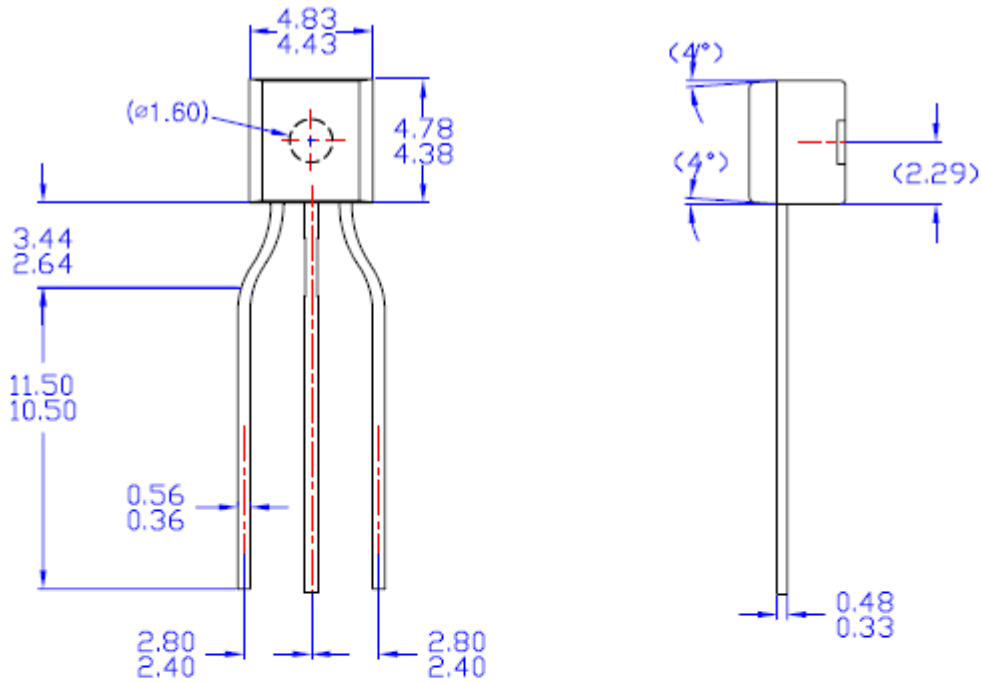

**NOTES:**

- A) THIS PACKAGE DOES NOT COMPLY TO ANY CURRENT PACKAGING STANDARD.
- B) ALL DIMENSIONS ARE IN MILLIMETERS.
- C) DRAWING CONFORMS TO ASME Y14.5M-1994
- D) DIMENSIONS ARE EXCLUSIVE OF BURRS, MOLD FLASH, AND TIE BAR EXTRUSIONS.

FILE NAME: MKT-TO-92J61Z

## Ordering Information

Product Number	Output Voltage Tolerance	Package	Operating Temperature	Shipping
FAN431ZXA	2%	TO-92	-25 ~ +85°C	Ammo Pack
FAN431AZXA	1%			
FAN431LZXA	0.5%			

- For information on tape & reel and ammo pack specifications, including part orientation and tape sizes, please refer to our tape and reel data, <http://www.fairchildsemi.com/products/analog/packaging/to92r.html>

### DISCLAIMER

FAIRCHILD SEMICONDUCTOR RESERVES THE RIGHT TO MAKE CHANGES WITHOUT FURTHER NOTICE TO ANY PRODUCTS HEREIN TO IMPROVE RELIABILITY, FUNCTION OR DESIGN. FAIRCHILD DOES NOT ASSUME ANY LIABILITY ARISING OUT OF THE APPLICATION OR USE OF ANY PRODUCT OR CIRCUIT DESCRIBED HEREIN; NEITHER DOES IT CONVEY ANY LICENSE UNDER ITS PATENT RIGHTS, NOR THE RIGHTS OF OTHERS.

### LIFE SUPPORT POLICY

FAIRCHILD'S PRODUCTS ARE NOT AUTHORIZED FOR USE AS CRITICAL COMPONENTS IN LIFE SUPPORT DEVICES OR SYSTEMS WITHOUT THE EXPRESS WRITTEN APPROVAL OF THE PRESIDENT OF FAIRCHILD SEMICONDUCTOR CORPORATION. As used herein:

1. Life support devices or systems are devices or systems which, (a) are intended for surgical implant into the body, or (b) support or sustain life, and (c) whose failure to perform when properly used in accordance with instructions for use provided in the labeling, can be reasonably expected to result in a significant injury of the user.
2. A critical component in any component of a life support device or system whose failure to perform can be reasonably expected to cause the failure of the life support device or system, or to affect its safety or effectiveness.

[www.fairchildsemi.com](http://www.fairchildsemi.com)