

MS7930

PRESSURE SENSOR DIE (0-30 BAR)



- 0 to 3000 kPa range (30 bar or 435 PSI)
- Absolute/differential pressure sensors
- High linearity, small size
- RoHS-compatible & Pb-free¹

DESCRIPTION

The sensor element of the MS7930 consists of a silicon micro-machined membrane. Implanted resistors make use of the piezo-resistive effect to sense the membrane deflection and transform it in an electrical signal. This sensor, which has outstanding linearity and span values, is available in various configurations. The absolute pressure sensor employs a sealed vacuum reference cavity underneath the membrane. The Pyrex glass wafer used for this sealing has a thickness of 0.2 mm (MS7930-A_0.2) or 0.5 mm (MS7930-A_0.5). There are two gauge versions available: one with a drilled Pyrex glass (MS7930-D) and the other without Pyrex glass (MS7930-S).

FEATURES

- Uncompensated pressure sensor die
- Output span 150mV @ 5V
- Temperature range -40°...+125°C
- Linearity 0.05% (typical)
- Very small die size 1.72 x 1.58 mm (MS7930-A)
- Low cost, high reliability

APPLICATION

- Absolute pressure sensor systems
- Differential/gauge pressure sensor systems
- Engine controls
- Dive computers

ELECTRICAL CONNECTIONS

Positive output for pressure applied topside

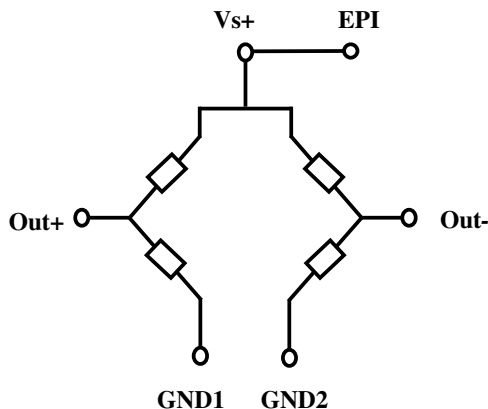

- Vs+ : Supply voltage of Wheatstone bridge
- Epi : Connection of epitaxial layer (membrane)
- Out- : Negative output
- Out+ : Positive output
- GND1 : Ground
- GND2 : Ground

¹ The European RoHS directive 2002/95/EC (Restriction of the use of certain Hazardous Substances in electrical and electronic equipment) bans the use of lead, mercury, cadmium, hexavalent chromium and polybrominated biphenyls (PBB) or polybrominated diphenyl ethers (PBDE).

BOND PAD CONFIGURATION

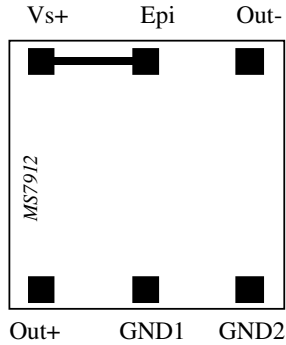

Important remarks:

As the sensing elements are diffused resistances, the voltage applied on the ground pads (GND1 and GND2) has to be lower than the voltage applied on supply voltage pad (Vs+).

The epitaxial layer is connected to the Vs+ pin under the pad.

Gold ball bonding or aluminium wedge bonding can be used to wire-bond the sensor. The quality of the wire-bonding is equipment and process dependant. For this reason, it is strongly recommended that a thorough wire-bonding qualification is made by the end user if the sensor is going to be operated over an extended temperature range.

LAYOUT (Absolute sensors)

MS7930-A_0.2

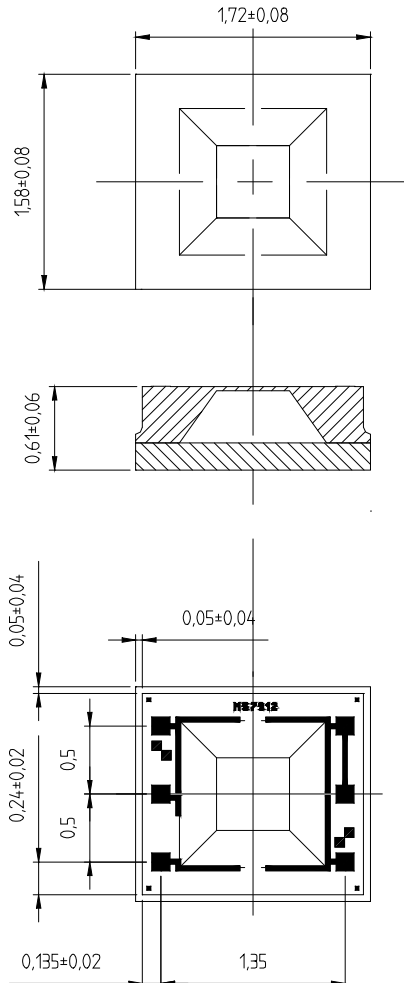

MS7930-A_0.5

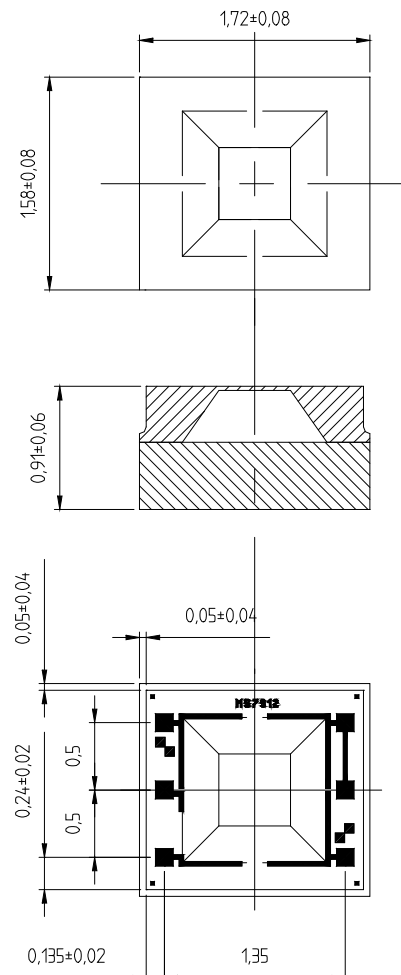

Pad opening in passivation is 100 µm

LAYOUT (Gauge sensors)

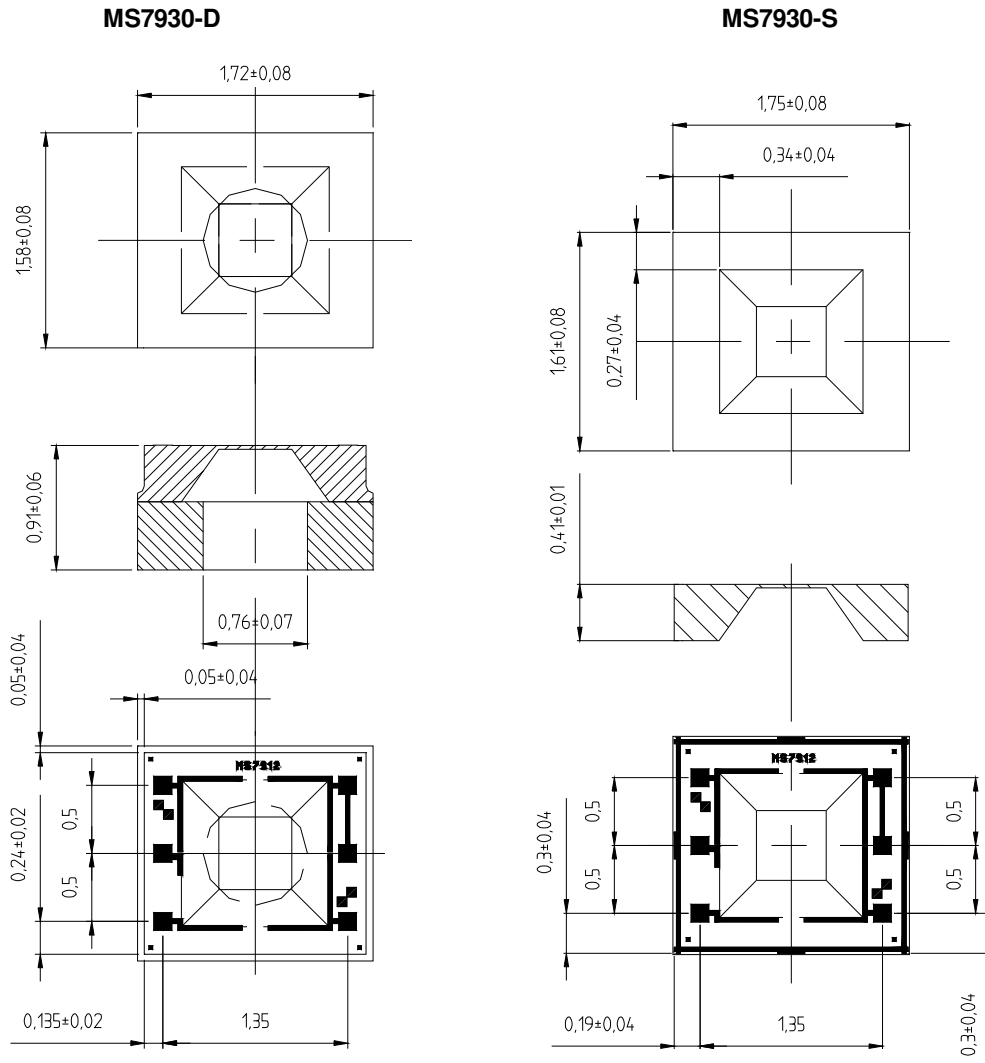

Pad opening in passivation is 100 μm

FULL SCALE PRESSURE

kPa	bar	mbar	PSI	atm	mm Hg	m H ₂ O	Inches H ₂ O
3000	30	30000	435.1	29.6	22502	306	12044

ABSOLUTE MAXIMUM RATINGS

Parameter	Symbol	Conditions	Min	Max	Unit
Supply voltage	VS+	T _a = 25 °C		20	V
Storage temperature	T _s		-40	+150	°C
Pressure overload				180	Bar

ELECTRICAL CHARACTERISTICS

(Reference conditions: Supply Voltage $V_{S+} = 5 \text{ Vdc}$; Ambient Temperature $T_a = 25^\circ\text{C}$)

Parameter	Min	Typ	Max	Unit	Notes
Operating Pressure Range	0		30	Bar	
Operating Temperature Range	-40		125	$^\circ\text{C}$	
Bridge Resistance	3.0	3.4	3.8	$\text{K}\Omega$	
Full-scale span (FS)	120	150	180	mV	
Zero Pressure Offset	-40	0	40	mV	
Linearity		± 0.05	± 0.15	% FS	1
Temperature Coefficient of Resistance Span Offset	+ 2400 - 1500 - 80	+ 2800 - 1900	+ 3300 - 2300 + 80	ppm/ $^\circ\text{C}$ ppm/ $^\circ\text{C}$ $\mu\text{V}/^\circ\text{C}$	2
Pressure Hysteresis		± 0.05	± 0.15	% FS	3
Repeatability		± 0.05	± 0.2	% FS	4
Temperature Hysteresis			0.3	% FS	5

NOTES

- 1) Deviation at one half full-scale pressure from the least squares best line fit over pressure range (0 to 30 bar).
- 2) Slope of the endpoint straight line from 25°C to 60°C .
- 3) Output deviation at any pressure within the specified range, when this pressure is cycled to and from the minimum or maximum rated pressure, at 25°C .
- 4) Same as 3) after 10 pressure cycles.
- 5) Maximum difference in offset after one thermal cycle from -40°C to $+125^\circ\text{C}$.

PICKING TOOLS

The MS7930 sensors have a sensitive membrane size of $0.5 \times 0.5 \text{ mm}$ and outer dimensions of $1.72 \times 1.58 \text{ mm}$ (MS7930-A_0.2, MS7930-A_0.5 and MS7930-D) and $1.75 \times 1.61 \text{ mm}$ (MS7930-S). The pick and place tool has to be of a soft material such as rubber (Hardness 78-97 Shore A). Its external size must fit the sensor and the vacuum cavity must be as large as the membrane itself. Successful tests have been made with specific SPT tools, see SPT drawing and references below.

Ensure that the ejection pins do not touch the membrane for gauge versions.

SPT references	RTR-A1-060x060
External dimension	TL & TW: 0.06 inch / 1.52 mm
Internal dimensions	$\varnothing\text{H}$: 0.035 inch / 0.89 mm

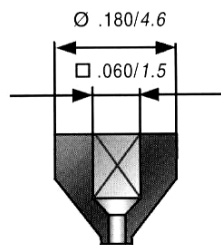

Type A

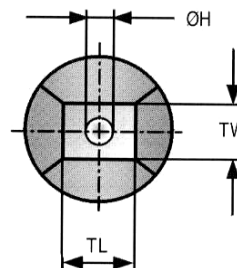

ORDERING INFORMATION

Product Code	Type	Product	Art.-Nr.
MS7930-A_0.2	Absolute	30 bar Pressure Sensors 0.2 mm Pyrex sawn on b/f	793025022
MS7930-A_0.5	Absolute	30 bar Pressure Sensors 0.5 mm Pyrex sawn on b/f	793025021
MS7930-D	Differential	30 bar Pressure Sensors sawn on b/f	793025121
MS7930-S	Differential	30 bar Pressure Sensors no Pyrex sawn on b/f	793025221

The MS7930 dice are supplied sawn on blue foil, mounted on plastic rings.

FACTORY AND SALES CONTACTS

Factory and European Sales office

Intersema Sensoric SA
Ch. Chapons-des-Prés 11
CH-2022 Bevaix
Switzerland

Phone: +41 32 847 9550
Fax: +41 32 847 9569
e-mail: sales@intersema.ch
Website: www.intersema.ch

USA

Measurement Specialties Inc.
1000 Lucas Way
Hampton, VA 23666
USA

Phone: +1 800 555 1551
Fax: +1 757 766 4297
e-mail: sales@meas-spec.com
Website: www.meas-spec.com

ASIA

Measurement Specialties (China), Ltd.
F1.6-4D, Tian An Development
Compound
Shenzhen, China 518048

Phone: +86 755 8330 1004
Fax: +86 755 8330 6797
e-mail: pfc.cs.asia@meas-spec.com
Website: www.meas-spec.com

NOTICE

Intersema reserves the right to make changes to the products contained in this data sheet in order to improve the design or performance and to supply the best possible products. Intersema assumes no responsibility for the use of any circuits shown in this data sheet, conveys no license under any patent or other rights unless otherwise specified in this data sheet, and makes no claim that the circuits are free from patent infringement. Applications for any devices shown in this data sheet are for illustration only and Intersema makes no claim or warranty that such applications will be suitable for the use specified without further testing or modification.