

P-CHANNEL ENHANCEMENT MODE POWER MOSFET

MTB14P03Q8

BV_{DSS}	-30V
I_D	-12A
$R_{DS(ON)(max)}$	14mΩ

Description

The MTB14P03Q8 is a P-channel enhancement-mode MOSFET, providing the designer with the best combination of fast switching, ruggedized device design, low on-resistance and cost effectiveness. The SOP-8 package is universally preferred for all commercial-industrial surface mount applications and suited for low voltage applications such as DC/DC converters.

Features

- $R_{DS(ON)}=14m\Omega @ V_{GS}=-10V, I_D=-12A$
 $R_{DS(ON)}=21m\Omega @ V_{GS}=-5V, I_D=-9A$
- Simple drive requirement
- Low on-resistance
- Fast switching speed
- Pb-free and Halogen-free package

Equivalent Circuit

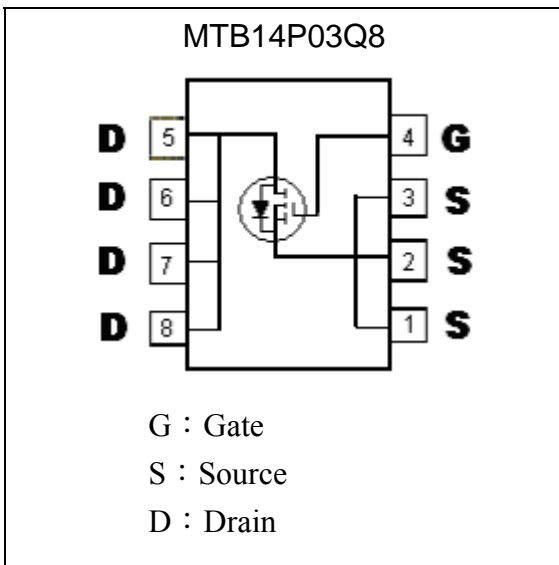

Outline

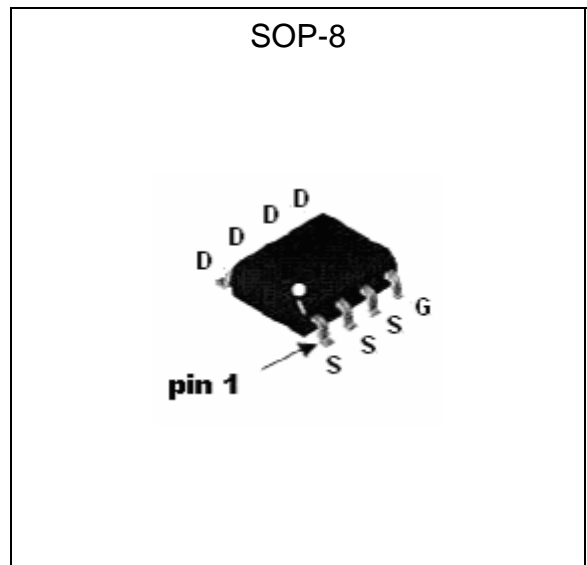



Absolute Maximum Ratings ($T_C=25^{\circ}\text{C}$, unless otherwise noted)

Parameter	Symbol	Limits	Unit
Drain-Source Breakdown Voltage	BV_{DSS}	-30	V
Gate-Source Voltage	V_{GS}	± 25	V
Continuous Drain Current @ $T_C=25^{\circ}\text{C}$	I_D	-12	A
Continuous Drain Current @ $T_C=100^{\circ}\text{C}$	I_D	-9	A
Pulsed Drain Current (Note 1)	I_{DM}	-48	A
Avalanche Current	I_{AS}	-20	A
Avalanche Energy @ $L=0.1\text{mH}$, $I_D=-20\text{A}$, $R_G=25\Omega$	E_{AS}	20	mJ
Power Dissipation	$T_A=25^{\circ}\text{C}$	3	W
	$T_A=100^{\circ}\text{C}$	1.5	W
Operating Junction and Storage Temperature Range	$T_j ; T_{stg}$	-55~+175	$^{\circ}\text{C}$

Note : 1.Pulse width limited by maximum junction temperature.

Electrical Characteristics ($T_C=25^{\circ}\text{C}$, unless otherwise noted)

Symbol	Min.	Typ.	Max.	Unit	Test Conditions
Static					
BV_{DSS}	-30	-	-	V	$V_{GS}=0$, $I_D=-250\mu\text{A}$
$V_{GS(th)}$	-1	-1.5	-3	V	$V_{DS}=V_{GS}$, $I_D=-250\mu\text{A}$
I_{GSS}	-	-	± 100	nA	$V_{GS}=\pm 25\text{V}$, $V_{DS}=0$
I_{DSS}	-	-	-1	μA	$V_{DS}=-24\text{V}$, $V_{GS}=0$
I_{DSS}	-	-	-10	μA	$V_{DS}=-20\text{V}$, $V_{GS}=0$, $T_j=125^{\circ}\text{C}$
$I_{D(ON)}$ (Note 1)	-12	-	-	A	$V_{DS}=-5\text{V}$, $V_{GS}=-10\text{V}$
$R_{DS(ON)}$ (Note 1)	-	12	14	m Ω	$I_D=-12\text{A}$, $V_{GS}=-10\text{V}$
	-	17	21		$I_D=-9\text{A}$, $V_{GS}=-5\text{V}$
G_{FS} (Note 1)	-	28	-	S	$V_{DS}=-5\text{V}$, $I_D=-12\text{A}$
Dynamic					
C_{iss}	-	6375	-	pF	$V_{DS}=-15\text{V}$, $V_{GS}=0$, $f=1\text{MHz}$
C_{oss}	-	1612	-		
C_{rss}	-	1481	-		
$t_{d(ON)}$ (Note 1&2)	-	26	-	ns	$V_{DS}=-15\text{V}$, $I_D=-1\text{A}$, $V_{GS}=-10\text{V}$, $R_G=2.7\Omega$
t_r (Note 1&2)	-	22	-		
$t_{d(OFF)}$ (Note 1&2)	-	75	-		
t_f (Note 1&2)	-	15	-		
$Q_g(V_{GS}=10\text{V})$ (Note 1&2)	-	56	-	nC	$V_{DS}=-15\text{V}$, $I_D=-10\text{A}$, $V_{GS}=-10\text{V}$,
$Q_g(V_{GS}=5\text{V})$ (Note 1&2)	-	40	-		
Q_{gs} (Note 1&2)	-	15	-		
Q_{gd} (Note 1&2)	-	18	-		



Electrical Characteristics(Cont.) (Tj=25°C, unless otherwise specified)

Symbol	Min.	Typ.	Max.	Unit	Test Conditions
Source-Drain Diode					
I _S	-	-	-3.6	A	
I _{SM} (Note 3)	-	-	-14.4		
V _{SD} (Note 1)	-	-	-1.2	V	I _F =I _S , V _{GS} =0V
trr	-	52	-	ns	I _F =I _S , dI _F /dt=100A/μs
Qrr	-	60	-	nC	

Note : 1.Pulse Test : Pulse Width ≤300μs, Duty Cycle≤2%
 2.Independent of operating temperature
 3.Pulse width limited by maximum junction temperature

Thermal Resistance Ratings

Thermal Resistance	Symbol	Typical	Maximum	Unit
Junction-to-Case	R _{θJC}		25	°C / W
Junction-to-Ambient (Note)	R _{θJA}		50	

Note : 50°C / W when mounted on a 1 in² pad of 2 oz copper.



Characteristic Curves

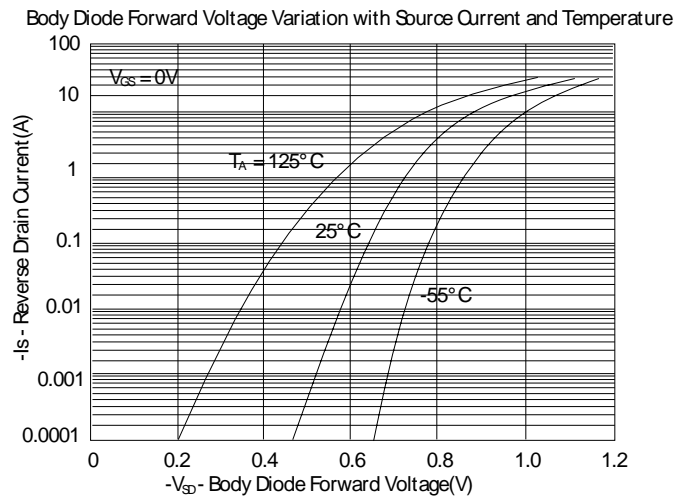
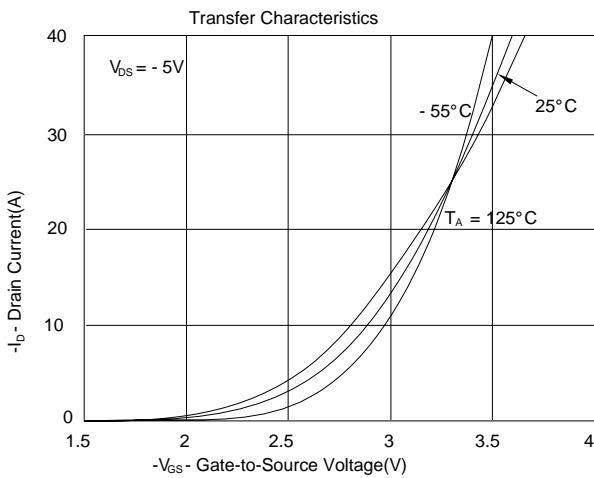
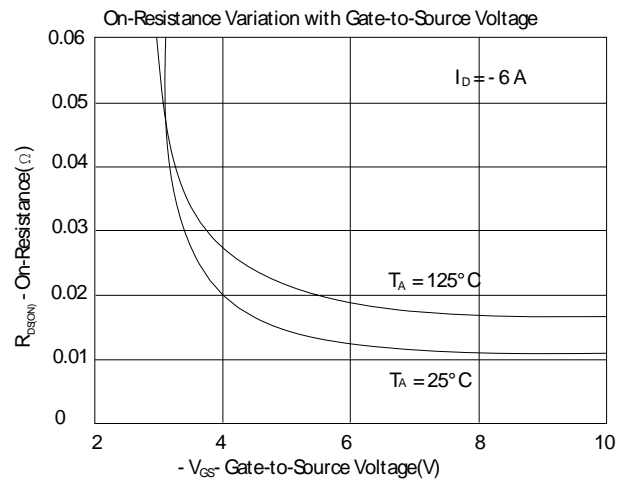
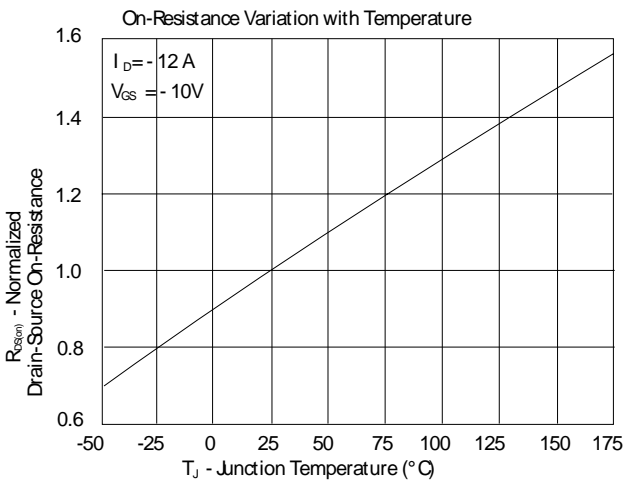
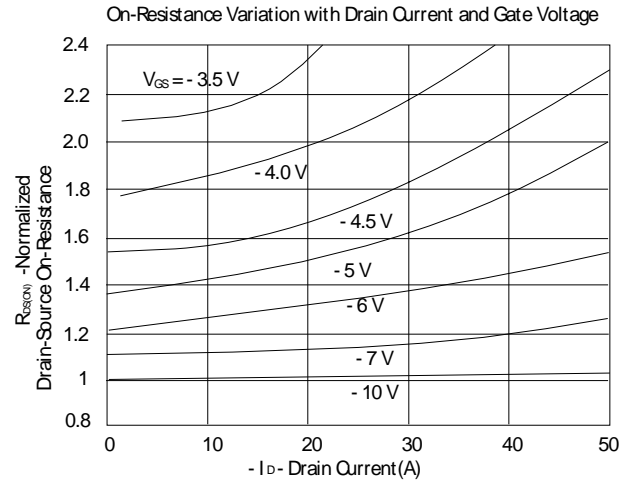
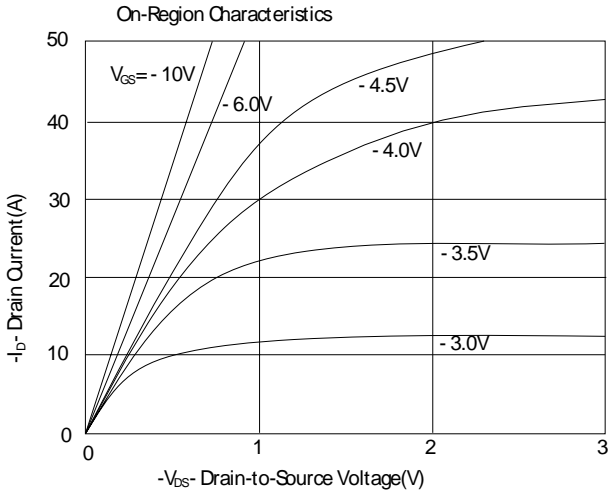



Characteristic Curves(Cont.)

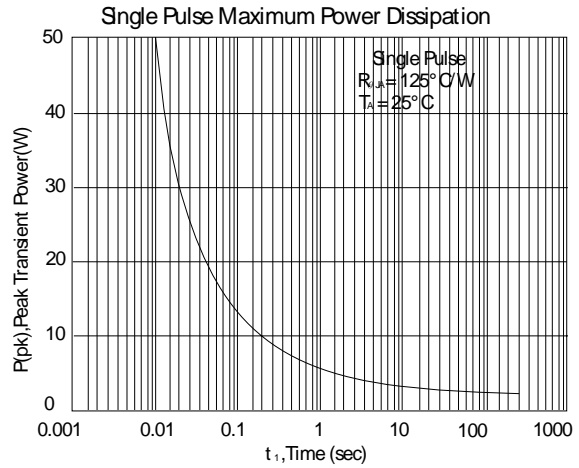
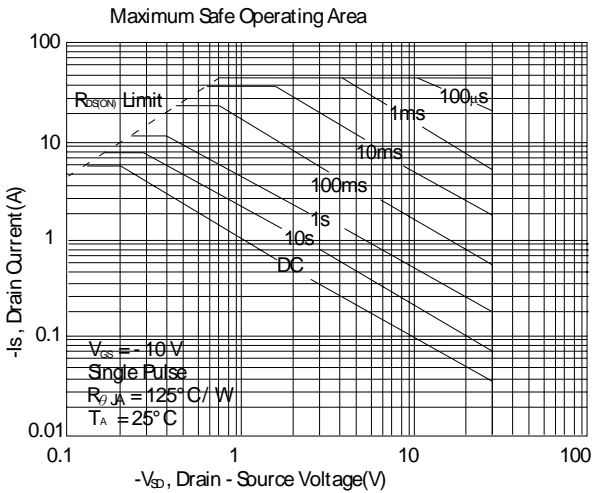
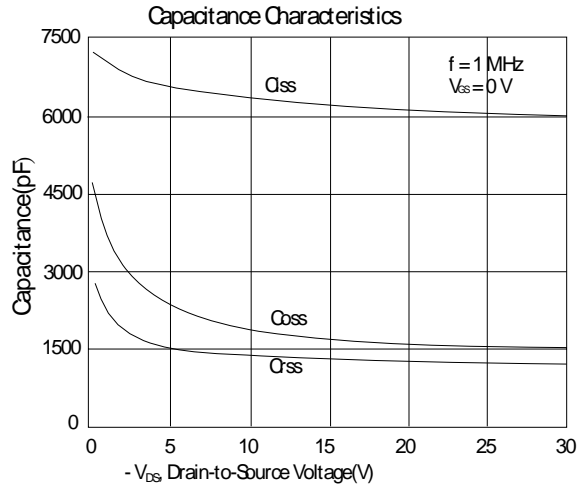
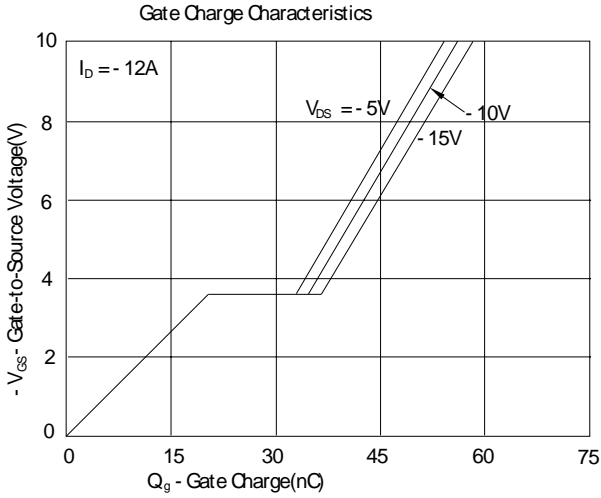

Transient Thermal Response Curve

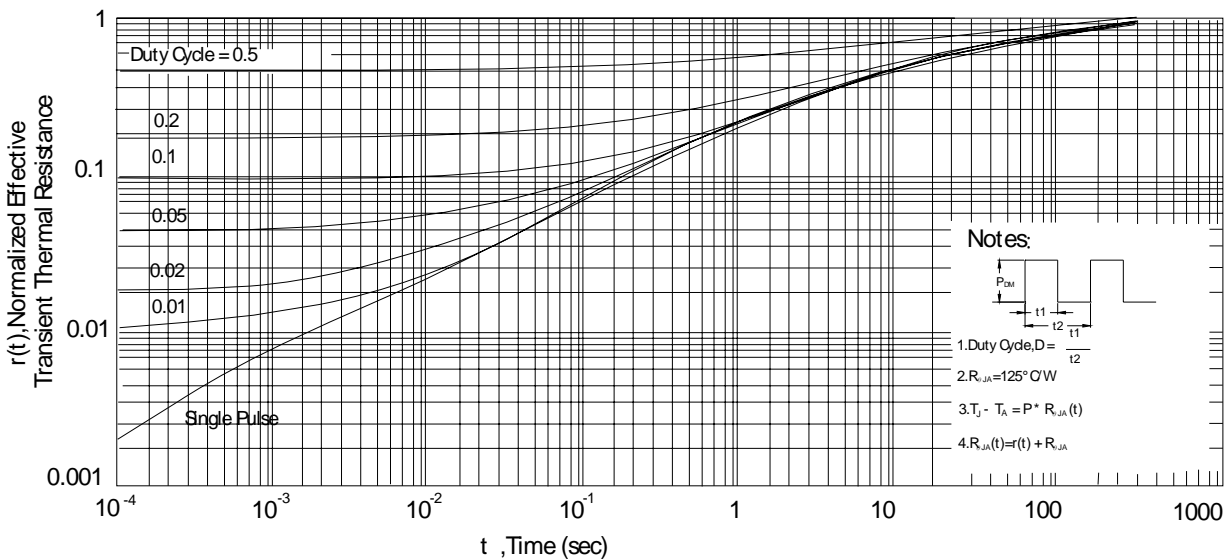

SOP-8 Dimension

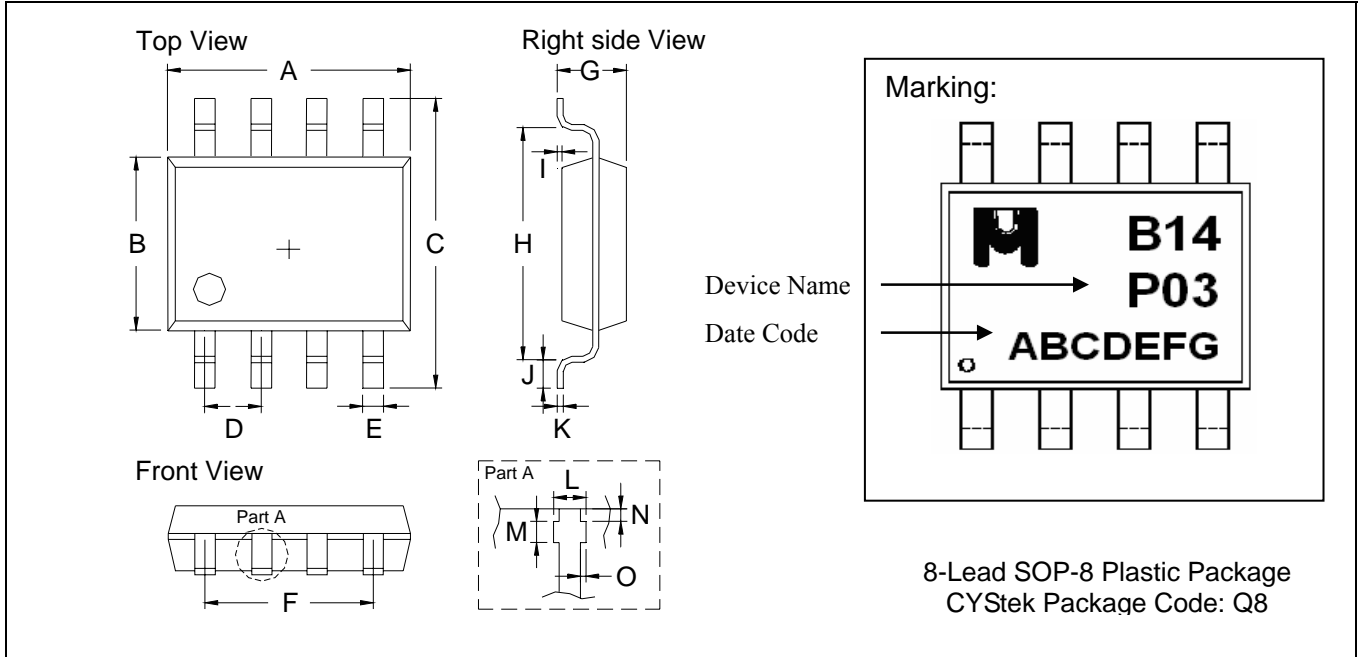

*: Typical

DIM	Inches		Millimeters		DIM	Inches		Millimeters	
	Min.	Max.	Min.	Max.		Min.	Max.	Min.	Max.
A	0.1909	0.2007	4.85	5.10	I	0.0019	0.0078	0.05	0.20
B	0.1515	0.1555	3.85	3.95	J	0.0118	0.0275	0.30	0.70
C	0.2283	0.2441	5.80	6.20	K	0.0074	0.0098	0.19	0.25
D	0.0480	0.0519	1.22	1.32	L	0.0145	0.0204	0.37	0.52
E	0.0145	0.0185	0.37	0.47	M	0.0118	0.0197	0.30	0.50
F	0.1472	0.1527	3.74	3.88	N	0.0031	0.0051	0.08	0.13
G	0.0570	0.0649	1.45	1.65	O	0.0000	0.0059	0.00	0.15
H	0.1889	0.2007	4.80	5.10					

Notes: 1.Controlling dimension: millimeters.
 2.Maximum lead thickness includes lead finish thickness, and minimum lead thickness is the minimum thickness of base material.
 3.If there is any question with packing specification or packing method, please contact your local CYStek sales office.

Material:

- Lead: pure tin plated
- Mold Compound: Epoxy resin family, flammability solid burning class: UL94V-0

Important Notice:

- All rights are reserved. Reproduction in whole or in part is prohibited without the prior written approval of CYStek.
- CYStek reserves the right to make changes to its products without notice.
- CYStek **semiconductor products are not warranted to be suitable for use in Life-Support Applications, or systems.**
- CYStek assumes no liability for any consequence of customer product design, infringement of patents, or application assistance.