

1.0A HIGH VOLTAGE SCHOTTKY BARRIER RECTIFIER
PowerDI[®]123
Features

- Guard Ring Die Construction for Transient Protection
- Low Power Loss, High Efficiency
- Patented Interlocking Clip Design for High Surge Current Capacity
- **Lead Free Finish, RoHS Compliant (Note 4)**
- **"Green" Molding Compound (No Br, Sb)**
- **Qualified to AEC-Q101 Standards for High Reliability**

Mechanical Data

- Case: PowerDI[®]123
- Case Material: Molded Plastic, "Green" Molding Compound. UL Flammability Classification Rating 94V-0
- Moisture Sensitivity: Level 1 per J-STD-020D
- Terminal Connections: Cathode Band
- Terminals: Finish – Matte Tin annealed over Copper Leadframe. Solderable per MIL-STD-202, Method 208 (E3)
- Marking Information: See Page 2
- Ordering Information: See Page 2
- Weight: 0.01 grams (approximate)



Top View

Maximum Ratings @T_A = 25°C unless otherwise specified

Single phase, half wave, 60Hz, resistive or inductive load.
 For capacitance load, derate current by 20%.

Characteristic	Symbol	Value	Unit
Peak Repetitive Reverse Voltage	V _{RRM}	200	V
Working Peak Reverse Voltage	V _{RWM}		
DC Blocking Voltage	V _R		
RMS Reverse Voltage	V _{R(RMS)}	141	V
Average Forward Current	I _{F(AV)}	1.0	A
Non-Repetitive Peak Forward Surge Current 8.3ms Single Half Sine-Wave Superimposed on Rated Load	I _{FSM}	40	A

Thermal Characteristics

Characteristic	Symbol	Typ	Max	Unit
Thermal Resistance Junction to Ambient (Note 1)	R _{θJA}	132	—	°C/W
Thermal Resistance Junction to Soldering Point (Note 2)	R _{θJS}	—	7	°C/W
Operating and Storage Temperature Range	T _J , T _{STG}	-65 to +175		°C

Electrical Characteristics @T_A = 25°C unless otherwise specified

Characteristic	Symbol	Min	Typ	Max	Unit	Test Condition
Reverse Breakdown Voltage (Note 3)	V _{(BR)R}	200	—	—	V	I _R = 8μA
Forward Voltage	V _F	—	—	0.85	V	I _F = 1.0A
Leakage Current (Note 3)	I _R	—	—	2	μA	V _R = 200V, T _A = 25°C
Total Capacitance	C _T	—	23	—	pF	V _R = 5VDC, f = 1MHz

- Notes:
1. Part mounted on FR-4 board with 2 oz., minimum recommended copper pad layout, which can be found on our website at <http://www.diodes.com/datasheets/ap02001.pdf>. T_A = 25°C
 2. Theoretical R_{θJS} calculated from the top center of the die straight down to the PCB/cathode tab solder junction.
 3. Short duration pulse test used to minimize self-heating effect.
 4. EU Directive 2002/95/EC (RoHS). All applicable RoHS exemptions applied, see *EU Directive 2002/95/EC Annex Notes*.

PowerDI is a registered trademark of Diodes Incorporated.

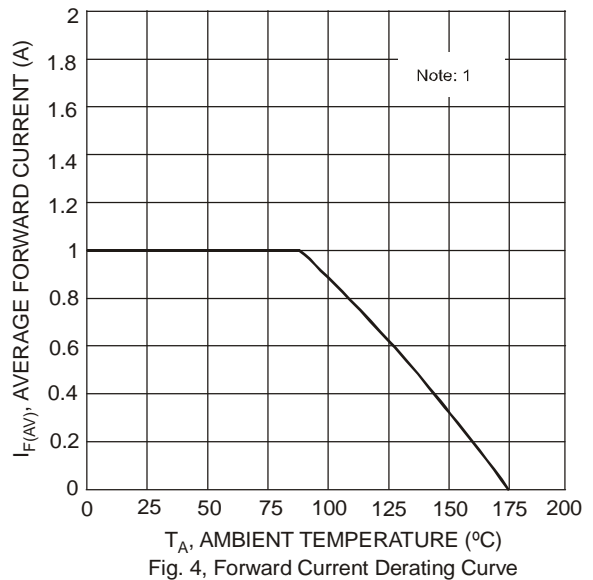
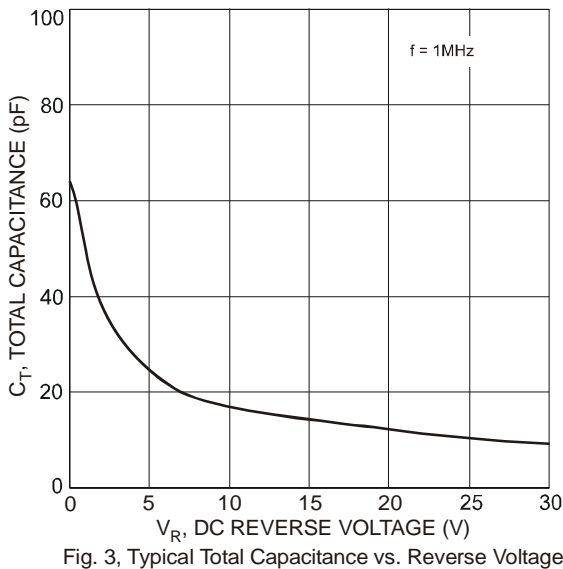
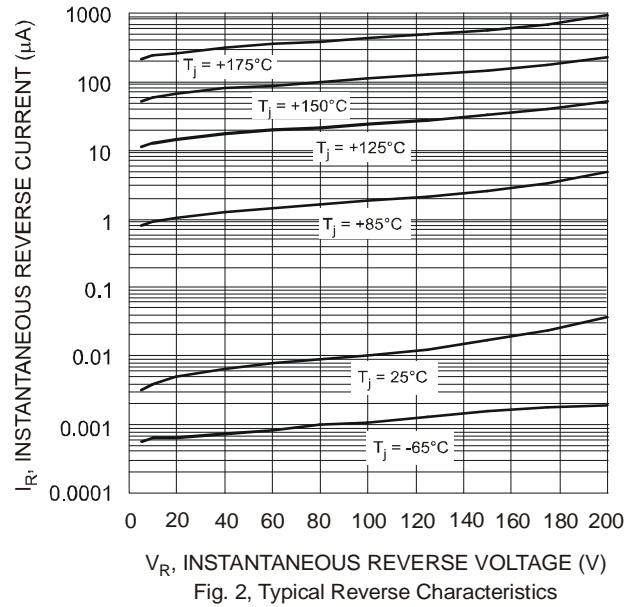
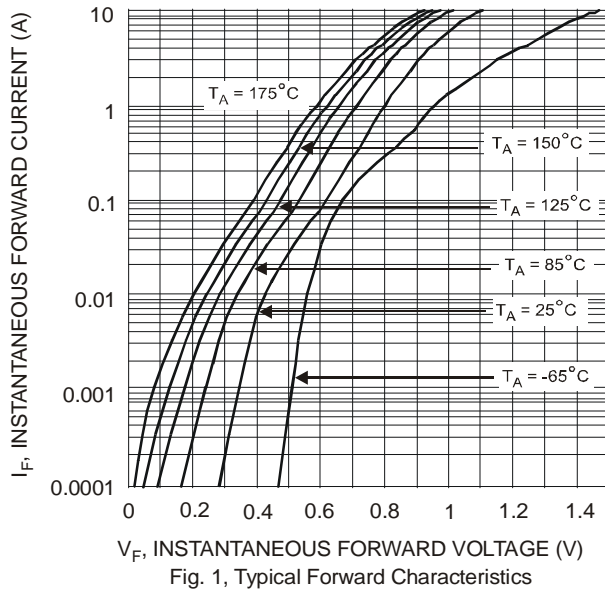

Ordering Information (Note 5)

Part Number	Case	Packaging
DFLS1200-7	PowerDI [®] 123	3000/Tape & Reel

Notes: 5. For packaging details, go to our website at <http://www.diodes.com/datasheets/ap02007.pdf>.

Marking Information

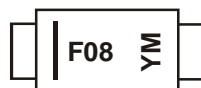

F08 = Product Type Marking Code
 YM = Date Code Marking
 Y = Year (ex: R = 2004)
 M = Month (ex: 9 = September)

Date Code Key

Year	2004	2005	2006	2007	2008	2009	2010	2011	2012
Code	R	S	T	U	V	W	X	Y	Z

Month	Jan	Feb	Mar	Apr	May	Jun	Jul	Aug	Sep	Oct	Nov	Dec
Code	1	2	3	4	5	6	7	8	9	O	N	D

PowerDI is a registered trademark of Diodes Incorporated.

Package Outline Dimensions

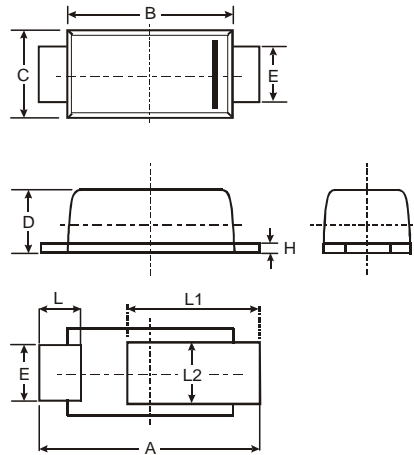

PowerDI [®] 123			
Dim	Min	Max	Typ
A	3.50	3.90	3.70
B	2.60	3.00	2.80
C	1.63	1.93	1.78
D	0.93	1.00	0.98
E	0.85	1.25	1.00
H	0.15	0.25	0.20
L	0.55	0.75	0.65
L1	1.80	2.20	2.00
L2	0.95	1.25	1.10
All Dimensions in mm			

Suggested Pad Layout

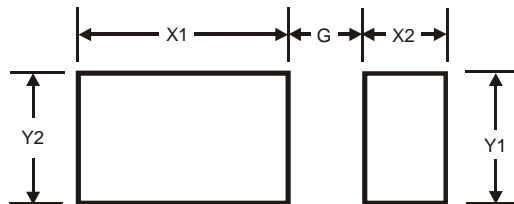

Dimensions	Value (in mm)
G	1.0
X1	2.2
X2	0.9
Y1	1.4
Y2	1.4

IMPORTANT NOTICE

Diodes Incorporated and its subsidiaries reserve the right to make modifications, enhancements, improvements, corrections or other changes without further notice to any product herein. Diodes Incorporated does not assume any liability arising out of the application or use of any product described herein; neither does it convey any license under its patent rights, nor the rights of others. The user of products in such applications shall assume all risks of such use and will agree to hold Diodes Incorporated and all the companies whose products are represented on our website, harmless against all damages.

LIFE SUPPORT

Diodes Incorporated products are not authorized for use as critical components in life support devices or systems without the expressed written approval of the President of Diodes Incorporated.