

1:10 LVPECL Fanout Buffer with Selectable Clock Input

Features

- Select one of two low-voltage positive emitter-coupled logic (LVPECL) input pairs to distribute to 10 LVPECL output pairs
- 40-ps maximum output-to-output skew
- 600-ps maximum propagation delay
- 0.11-ps maximum additive RMS phase jitter at 156.25 MHz (12-kHz to 20-MHz offset)
- Up to 1.5-GHz operation
- 32-Pin thin quad flat pack (TQFP) package
- 2.5-V or 3.3-V operating voltage^[1]
- Commercial and industrial operating temperature range

Functional Description

The CY2DP1510 is an ultra-low noise, low skew, low-propagation delay 1:10 LVPECL fanout buffer targeted to meet the requirements of high-speed clock distribution applications. The CY2DP1510 can select between two separate LVPECL input clock pairs using the IN_SEL pin. The device has a fully differential internal architecture that is optimized to achieve low additive jitter and low skew at operating frequencies of up to 1.5 GHz.

Logic Block Diagram

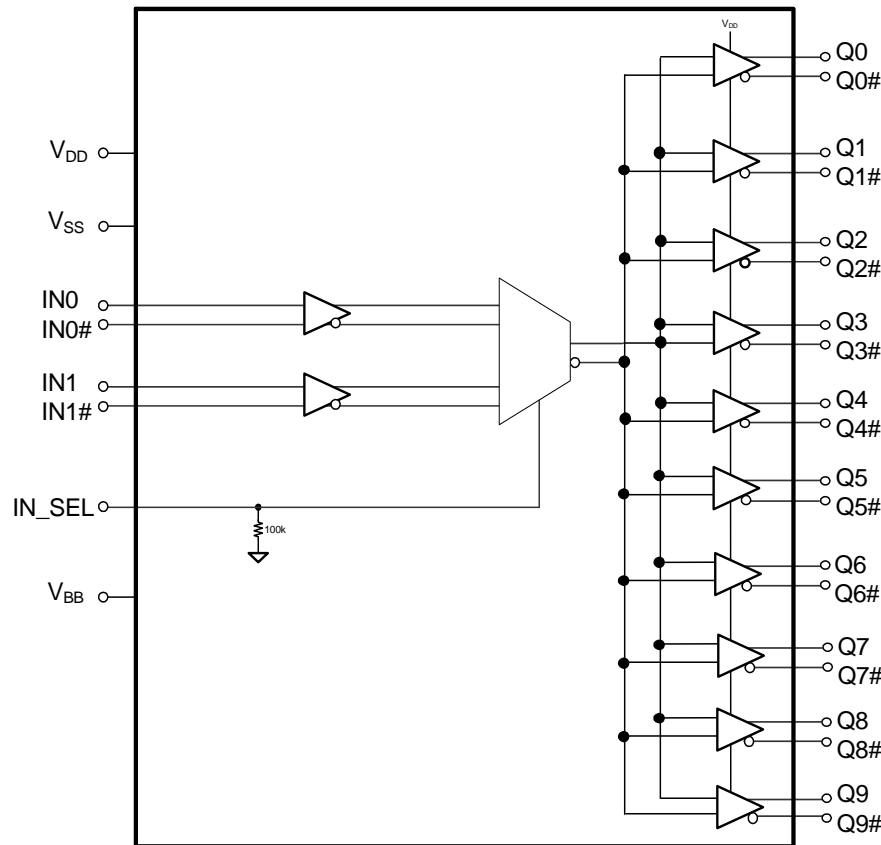

Note

1. Input AC-coupling capacitors are required for voltage-translation applications.

Contents

Pinouts	3	Document Conventions	11
Absolute Maximum Ratings	4	Document History Page	12
Operating Conditions	4	Sales, Solutions, and Legal Information	13
DC Electrical Specifications	5	Worldwide Sales and Design Support	13
AC Electrical Specifications	6	Products	13
Ordering Information	9	PSoC Solutions	13
Ordering Code Definition	9		
Package Dimension	10		
Acronyms	11		

Pinouts

Figure 1. Pin Diagram – 32-Pin TQFP Package

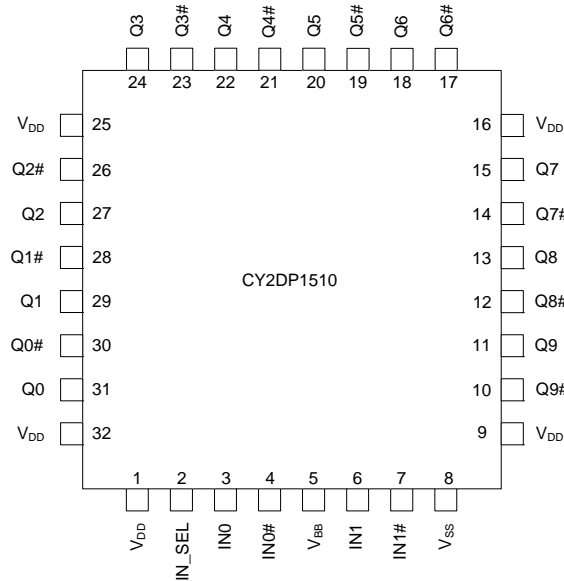

Table 1. Pin Definitions

Pin No.	Pin Name	Pin Type	Description
1, 9, 16, 25, 32	V _{DD}	Power	Power supply
2	IN_SEL	Input	Input clock select pin. Low-voltage complementary metal oxide semiconductor (LVCMOS)/low-voltage transistor-transistor-logic (LVTTTL). When IN_SEL = Low, the IN0/IN0# differential input pair is active. When IN_SEL = High, the IN1/IN1# differential input pair is active.
3	IN0	Input	LVPECL input clock. Active when IN_SEL = Low
4	IN0#	Input	LVPECL complementary input clock. Active when IN_SEL = Low
5	V _{BB}	Output	LVPECL reference voltage output
6	IN1	Input	LVPECL input clock. Active when IN_SEL = High
7	IN1#	Input	LVPECL complementary input clock. Active when IN_SEL = High
8	V _{SS}	Power	Ground
10,12,14,17,19,21,23,26,28,30	Q(0:9)#	Output	LVPECL complementary output clocks
11,13,15,18,20,22,24,27,29,31	Q(0:9)	Output	LVPECL output clocks
–	EPAD	–	Exposed paddle. Connect to ground plane for package heat dissipation. No electrical connection.

Absolute Maximum Ratings

Parameter	Description	Condition	Min	Max	Unit
V_{DD}	Supply voltage	Nonfunctional	-0.5	4.6	V
$V_{IN}^{[2]}$	Input voltage, relative to V_{SS}	Nonfunctional	-0.5	lesser of 4.0 or $V_{DD} + 0.4$	V
$V_{OUT}^{[2]}$	DC output or I/O voltage, relative to V_{SS}	Nonfunctional	-0.5	lesser of 4.0 or $V_{DD} + 0.4$	V
T_S	Storage temperature	Nonfunctional	-55	150	°C
ESD_{HBM}	Electrostatic discharge (ESD) protection (Human body model)	JEDEC STD 22-A114-B	2000	-	V
L_U	Latch up		Meets or exceeds JEDEC Spec JESD78B IC latch up test		
UL-94	Flammability rating	At 1/8 in	V-0		
MSL	Moisture sensitivity level		3		

Operating Conditions

Parameter	Description	Condition	Min	Max	Unit
V_{DD}	Supply voltage	2.5-V supply	2.375	2.625	V
		3.3-V supply	3.135	3.465	V
T_A	Ambient operating temperature	Commercial	0	70	°C
		Industrial	-40	85	°C
t_{PU}	Power ramp time	Power-up time for V_{DD} to reach minimum specified voltage (power ramp must be monotonic).	0.05	500	ms

Note

2. The voltage on any I/O pin cannot exceed the power pin during power up. Power supply sequencing is not required.

DC Electrical Specifications

($V_{DD} = 3.3\text{ V} \pm 5\%$ or $2.5\text{ V} \pm 5\%$; $T_A = 0\text{ }^\circ\text{C}$ to $70\text{ }^\circ\text{C}$ (Commercial) or $-40\text{ }^\circ\text{C}$ to $85\text{ }^\circ\text{C}$ (Industrial))

Parameter	Description	Condition	Min	Max	Unit
I_{DD}	Operating supply current	All LVPECL outputs floating (internal I_{DD})	–	120	mA
V_{IH1}	Input high voltage, LVPECL input clocks IN0 and IN0#, IN1 and IN1#		–	$V_{DD} + 0.3$	V
V_{IL1}	Input low voltage, LVPECL input clocks IN0 and IN0#, IN1 and IN1#		–0.3	–	V
V_{IH2}	Input high voltage, IN_SEL	$V_{DD} = 3.3\text{ V}$	2.0	$V_{DD} + 0.3$	V
V_{IL2}	Input low voltage, IN_SEL	$V_{DD} = 3.3\text{ V}$	–0.3	0.8	V
V_{IH3}	Input high voltage, IN_SEL	$V_{DD} = 2.5\text{ V}$	1.7	$V_{DD} + 0.3$	V
V_{IL3}	Input low voltage, IN_SEL	$V_{DD} = 2.5\text{ V}$	–0.3	0.7	V
$V_{ID}^{[3]}$	Input differential amplitude	See Figure 2 on page 7	0.4	1.0	V
V_{ICM}	Input common mode voltage	See Figure 2 on page 7	0.5	$V_{DD} - 0.2$	V
I_{IH}	Input high current, All inputs	Input = $V_{DD}^{[4]}$	–	150	μA
I_{IL}	Input low current, All inputs	Input = $V_{SS}^{[4]}$	–150	–	μA
V_{OH}	LVPECL output high voltage	Terminated with $50\ \Omega$ to $V_{DD} - 2.0^{[5]}$	$V_{DD} - 1.20$	$V_{DD} - 0.70$	V
V_{OL}	LVPECL output low voltage	Terminated with $50\ \Omega$ to $V_{DD} - 2.0^{[5]}$	$V_{DD} - 2.0$	$V_{DD} - 1.63$	V
V_{BB}	Output reference voltage	0 to $150\ \mu\text{A}$ output current	$V_{DD} - 1.40$	$V_{DD} - 1.16$	V
R_P	Internal pull-down resistance	IN_SEL pin	60	140	$\text{k}\Omega$
C_{IN}	Input capacitance	Measured at 10 MHz; per pin	–	3	pF

Notes

- V_{ID} minimum of 400 mV is required to meet all output AC electrical specifications. The device is functional with V_{ID} minimum of greater than 200 mV.
- Positive current flows into the input pin, negative current flows out of the input pin.
- Refer to [Figure 3](#) on page 7.

AC Electrical Specifications

($V_{DD} = 3.3\text{ V} \pm 5\%$ or $2.5\text{ V} \pm 5\%$; $T_A = 0\text{ }^\circ\text{C}$ to $70\text{ }^\circ\text{C}$ (Commercial) or $-40\text{ }^\circ\text{C}$ to $85\text{ }^\circ\text{C}$ (Industrial))

Parameter	Description	Condition	Min	Typ	Max	Unit
F_{IN}	Input frequency		DC	–	1.5	GHz
F_{OUT}	Output frequency	$F_{OUT} = F_{IN}$	DC	–	1.5	GHz
V_{PP}	LVPECL differential output voltage peak to peak, single ended. Terminated with $50\ \Omega$ to $V_{DD} - 2.0$ ^[6]	$F_{out} = \text{DC to } 150\text{ MHz}$	600	–	–	mV
		$F_{out} = >150\text{ MHz to } 1.5\text{ GHz}$	400	–	–	mV
t_{PD} ^[7]	Propagation delay input pair to output pair	Input rise/fall time < 1.5 ns (20% to 80%)	–	–	600	ps
t_{ODC} ^[8]	Output duty cycle	50% duty cycle at input Frequency range up to 1 GHz	48	–	52	%
t_{SK1} ^[9]	Output-to-output skew	Any output to any output, with same load conditions at DUT	–	–	40	ps
$t_{SK1 D}$ ^[9]	Device-to-device output skew	Any output to any output between two or more devices. Devices must have the same input and have the same output load.	–	–	150	ps
PN_{ADD}	Additive RMS phase noise 156.25-MHz input Rise/fall time < 150 ps (20% to 80%) $V_{ID} > 400\text{ mV}$	Offset = 1 kHz	–	–	–120	dBc/Hz
		Offset = 10 kHz	–	–	–130	dBc/Hz
		Offset = 100 kHz	–	–	–140	dBc/Hz
		Offset = 1 MHz	–	–	–150	dBc/Hz
		Offset = 10 MHz	–	–	–154	dBc/Hz
		Offset = 20 MHz	–	–	–155	dBc/Hz
t_{JIT} ^[10]	Additive RMS phase jitter (Random)	156.25 MHz, 12 kHz to 20 MHz offset; input rise/fall time < 150 ps (20% to 80%), $V_{ID} > 400\text{ mV}$	–	–	0.11	ps
$t_{R,tF}$ ^[11]	Output rise/fall time	50% duty cycle at input, 20% to 80% of full swing (V_{OL} to V_{OH}) Input rise/fall time < 1.5 ns (20% to 80%)	–	–	300	ps

Notes

6. Refer to [Figure 3](#) on page 7.
7. Refer to [Figure 4](#) on page 7.
8. Refer to [Figure 5](#) on page 7.
9. Refer to [Figure 6](#) on page 8.
10. Refer to [Figure 7](#) on page 8.
11. Refer to [Figure 8](#) on page 8.

Figure 2. Input Differential and Common Mode Voltages

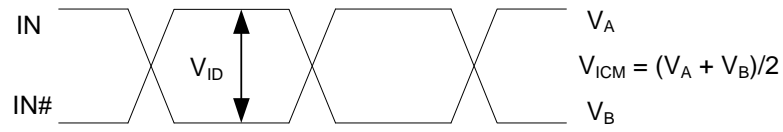

Figure 3. Output Differential Voltage

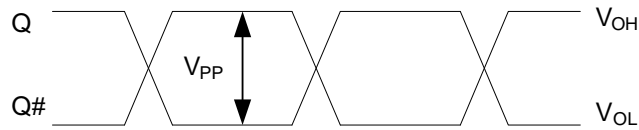

Figure 4. Input to Any Output Pair Propagation Delay

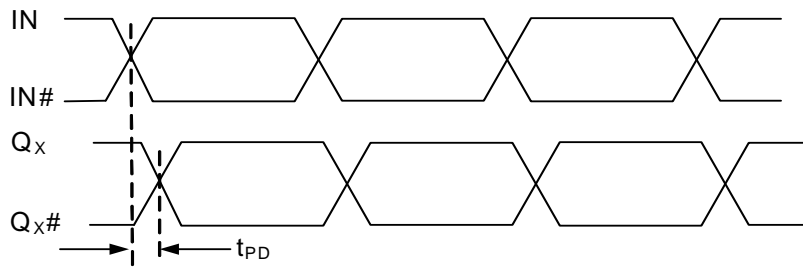

Figure 5. Output Duty Cycle

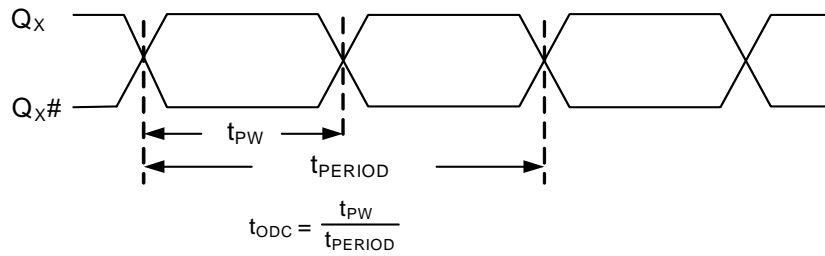

Figure 6. Output-to-Output and Device-to-Device Skew

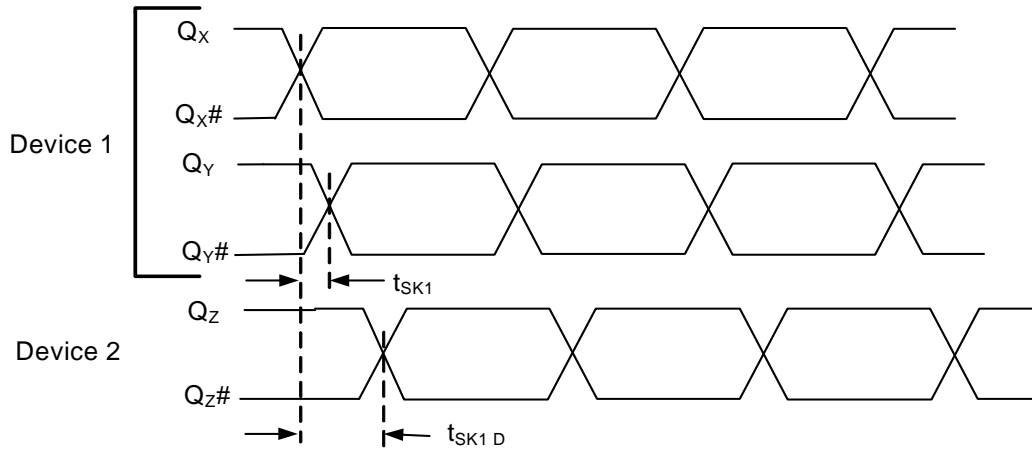

Figure 7. RMS Phase Jitter

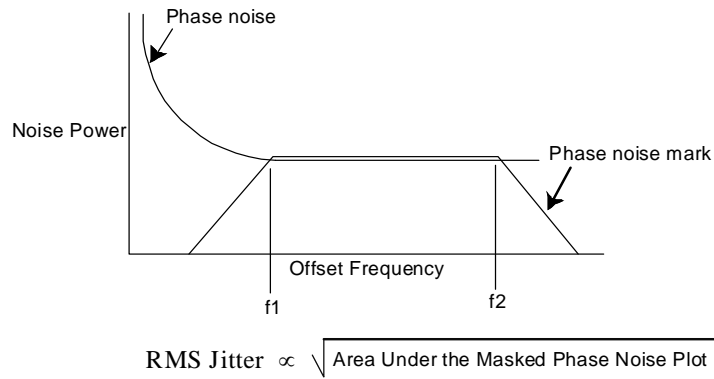
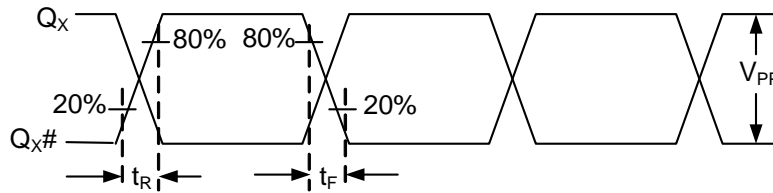

Figure 8. Output Rise/Fall Time



Ordering Information

Part Number	Type	Production Flow
Pb-free		
CY2DP1510AXC	32-Pin TQFP	Commercial, 0 °C to 70 °C
CY2DP1510AXCT	32-Pin TQFP tape and reel	Commercial, 0 °C to 70 °C
CY2DP1510AXI	32-Pin TQFP	Industrial, -40 °C to 85 °C
CY2DP1510AXIT	32-Pin TQFP tape and reel	Industrial, -40 °C to 85 °C

Ordering Code Definition

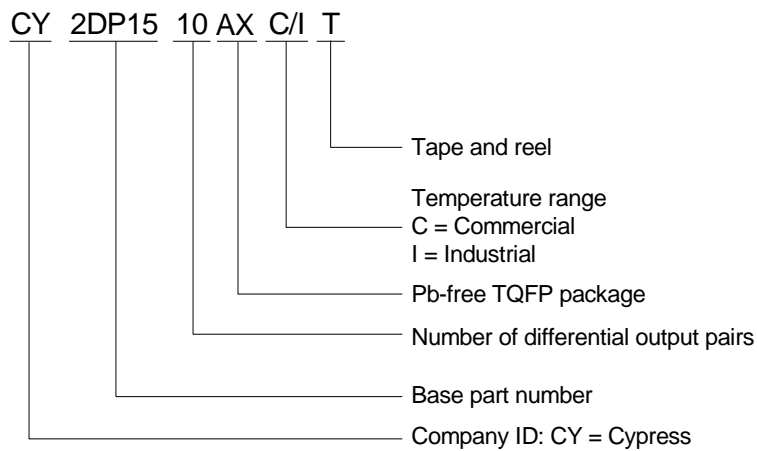

Package Dimension

Figure 9. 32-Pin Thin Plastic Quad Flat Pack 7 x 7 x 1.0 mm

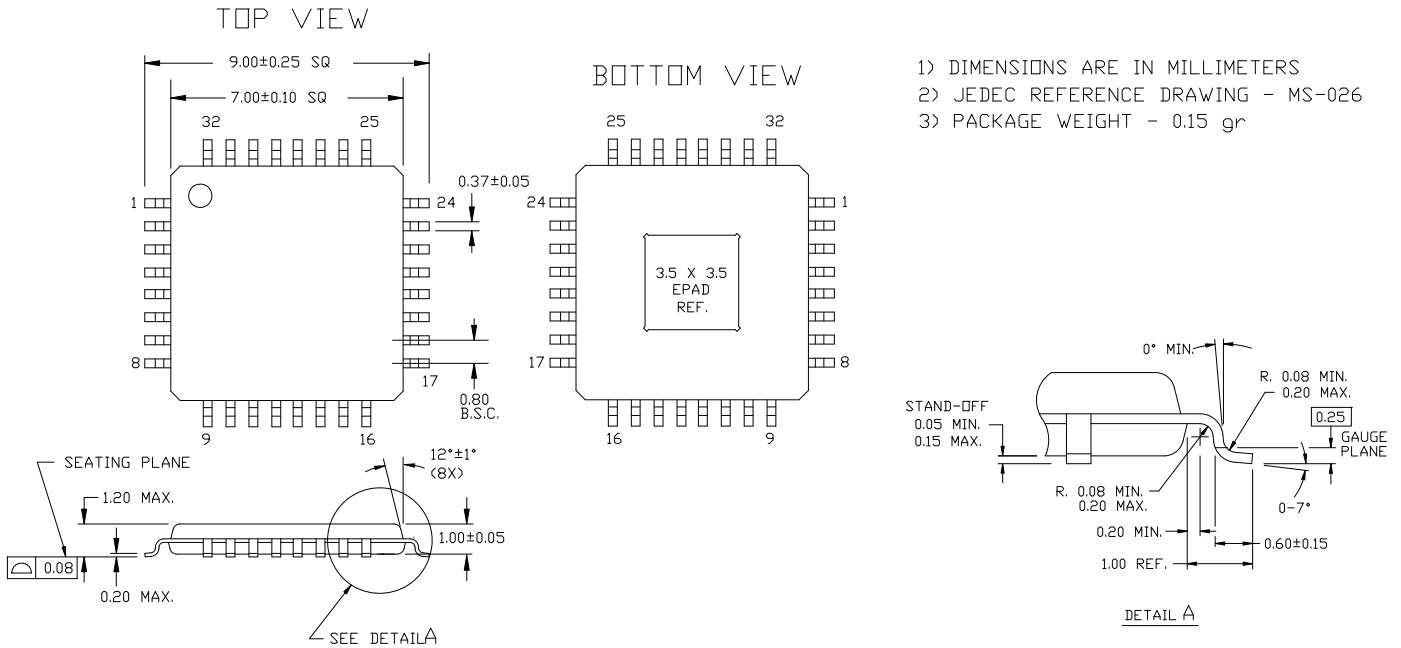

- 1) DIMENSIONS ARE IN MILLIMETERS
- 2) JEDEC REFERENCE DRAWING - MS-026
- 3) PACKAGE WEIGHT - 0.15 gr

001-54497 *A

Acronyms

Table 2. Acronyms Used in this Document

Acronym	Description
ESD	electrostatic discharge
HBM	human body model
JEDEC	Joint electron devices engineering council
LVDS	low-voltage differential signal
LVC MOS	low-voltage complementary metal oxide semiconductor
LVPECL	low-voltage positive emitter-coupled logic
LVTTTL	low-voltage transistor-transistor logic
OE	Output enable
RMS	root mean square
TQFP	thin quad flat pack

Document Conventions

Table 3. Units of Measure

Symbol	Unit of Measure
°C	degree Celsius
dBc	decibels relative to the carrier
GHz	giga hertz
Hz	hertz
KΩ	kilo ohm
μA	microamperes
μF	micro Farad
μs	microsecond
mA	milliamperes
ms	millisecond
mV	millivolt
MHz	megahertz
ns	nanosecond
Ω	ohm
pF	pico Farad
ps	pico second
V	volts
W	watts

Document History Page

Document Title: CY2DP1510 1:10 LVPECL Fanout Buffer with Selectable Clock Input				
Document Number: 001-55566				
Revision	ECN	Orig. of Change	Submission Date	Description of Change
**	2782891	CXQ	10/09/09	New Datasheet.
*A	2838916	CXQ	01/05/2010	<p>Changed status from "ADVANCE" to "PRELIMINARY".</p> <p>Changed from 0.34 ps to 0.25 ps maximum additive jitter in "Features" on page 1 and in t_{JIT} in the AC Electrical Specs table on page 5.</p> <p>Added t_{PU} spec to the Operating Conditions table on page 3.</p> <p>Changed V_{OH} in the DC Electrical Specs table on page 4: minimum from $V_{DD} - 1.15V$ to $V_{DD} - 1.20V$; maximum from $V_{DD} - 0.75V$ to $V_{DD} - 0.70V$.</p> <p>Removed V_{OD} spec in the DC Electrical Specs table on page 4.</p> <p>Changed V_{BB} max spec in the DC Electrical Specs table on page 4 from $V_{DD} - 1.38V$ to $V_{DD} - 1.40V$.</p> <p>Added R_P spec in the DC Electrical Specs table on page 4. Min = 60 kΩ, Max = 140 kΩ.</p> <p>Added a measurement definition for C_{IN} in the DC Electrical Specs table on page 4.</p> <p>Added V_{PP} spec to the AC Electrical Specs table on page 5. V_{PP} min = 600 mV for DC - 150 MHz and min = 400 mV for 150 MHz to 1.5 GHz.</p> <p>Changed letter case and some names of all the timing parameters in the AC Electrical Specs table on page 5 to be consistent with EROS.</p> <p>Lowered all additive phase noise mask specs by 3 dB in the AC Electrical Specs table on page 5.</p> <p>Added condition to t_R and t_F specs in the AC Electrical specs table on page 5 that input rise/fall time must be less than 1.5 ns (20% to 80%).</p> <p>Changed letter case and some names of all the timing parameters in Figures 3, 4, 5, 6 and 8, to be consistent with EROS.</p>
*B	2885033	CXQ	02/26/2010	Updated 32-Pin TQFP package diagram.
*C	3011766	CXQ	08/23/2010	<p>Changed from 0.25 ps to 0.11 ps maximum additive jitter in "Features" on page 1 and in t_{JIT} in the AC Electrical Specs table on page 6.</p> <p>Added description of EPAD to Table 1 pin definitions.</p> <p>Added note 3 to describe I_{IH} and I_{IL} specs.</p> <p>Changed V_{BB} max from $V_{DD} - 1.26V$ to $V_{DD} - 1.16V$ in DC Electrical Specs.</p> <p>Removed reference to data distribution from "Functional Description".</p> <p>Changed R_P for differential inputs from 100 kΩ to 150 kΩ in the Logic Block Diagram and from 60 kΩ min / 140 kΩ max to 90 kΩ min / 210 kΩ max in the DC Electrical Specs table.</p> <p>Added max V_{ID} of 1.0V in DC Electrical Specs table.</p> <p>Changed t_{PD} max spec from 480 ps to 600 ps.</p> <p>Updated phase noise specs for 1 k/10 k/100 k/1 M/10 M/20 MHz offset to -120/-130/-135/-150/-150/-150dBc/Hz, respectively, in the AC Electrical Specs table.</p> <p>Added "Frequency range up to 1 GHz" condition to t_{ODC} spec.</p> <p>Updated package drawing to 001-54497 to reflect use of EPAD package.</p> <p>Added Acronyms and Ordering Code Definition.</p>
*D	3017258	CXQ	08/27/2010	Corrected Output Rise/Fall time diagram.
*E	3100234	CXQ	11/18/2010	<p>Changed V_{IN} and V_{OUT} specs from 4.0V to "lesser of 4.0 or $V_{DD} + 0.4$"</p> <p>Removed 200mA min LU spec, replaced with "Meets or exceeds JEDEC Spec JESD78B IC Latchup Test"</p> <p>Removed R_P spec for differential input clock pins IN_X and $IN_X\#$.</p> <p>Changed C_{IN} condition to "Measured at 10 MHz".</p> <p>Changed PN_{ADD} specs for 100kHz, 10MHz, and 20MHz offsets.</p>
*F	3135201	CXQ	01/12/2011	<p>Removed "Preliminary" status heading.</p> <p>Removed pull-up/pull-down resistors from $IN_X/IN_X\#$ pins in Logic Block Diagram.</p>
*G	3090938	CXQ	02/25/2011	Post to external web.

Sales, Solutions, and Legal Information

Worldwide Sales and Design Support

Cypress maintains a worldwide network of offices, solution centers, manufacturer's representatives, and distributors. To find the office closest to you, visit us at [Cypress Locations](#).

Products

Automotive	cypress.com/go/automotive
Clocks & Buffers	cypress.com/go/clocks
Interface	cypress.com/go/interface
Lighting & Power Control	cypress.com/go/powerpsoc cypress.com/go/plc
Memory	cypress.com/go/memory
Optical & Image Sensing	cypress.com/go/image
PSoC	cypress.com/go/psoc
Touch Sensing	cypress.com/go/touch
USB Controllers	cypress.com/go/USB
Wireless/RF	cypress.com/go/wireless

PSoC Solutions

[psoc.cypress.com/solutions](#)
[PSoC 1](#) | [PSoC 3](#) | [PSoC 5](#)

© Cypress Semiconductor Corporation, 2009-2011. The information contained herein is subject to change without notice. Cypress Semiconductor Corporation assumes no responsibility for the use of any circuitry other than circuitry embodied in a Cypress product. Nor does it convey or imply any license under patent or other rights. Cypress products are not warranted nor intended to be used for medical, life support, life saving, critical control or safety applications, unless pursuant to an express written agreement with Cypress. Furthermore, Cypress does not authorize its products for use as critical components in life-support systems where a malfunction or failure may reasonably be expected to result in significant injury to the user. The inclusion of Cypress products in life-support systems application implies that the manufacturer assumes all risk of such use and in doing so indemnifies Cypress against all charges.

Any Source Code (software and/or firmware) is owned by Cypress Semiconductor Corporation (Cypress) and is protected by and subject to worldwide patent protection (United States and foreign), United States copyright laws and international treaty provisions. Cypress hereby grants to licensee a personal, non-exclusive, non-transferable license to copy, use, modify, create derivative works of, and compile the Cypress Source Code and derivative works for the sole purpose of creating custom software and or firmware in support of licensee product to be used only in conjunction with a Cypress integrated circuit as specified in the applicable agreement. Any reproduction, modification, translation, compilation, or representation of this Source Code except as specified above is prohibited without the express written permission of Cypress.

Disclaimer: CYPRESS MAKES NO WARRANTY OF ANY KIND, EXPRESS OR IMPLIED, WITH REGARD TO THIS MATERIAL, INCLUDING, BUT NOT LIMITED TO, THE IMPLIED WARRANTIES OF MERCHANTABILITY AND FITNESS FOR A PARTICULAR PURPOSE. Cypress reserves the right to make changes without further notice to the materials described herein. Cypress does not assume any liability arising out of the application or use of any product or circuit described herein. Cypress does not authorize its products for use as critical components in life-support systems where a malfunction or failure may reasonably be expected to result in significant injury to the user. The inclusion of Cypress' product in a life-support systems application implies that the manufacturer assumes all risk of such use and in doing so indemnifies Cypress against all charges.

Use may be limited by and subject to the applicable Cypress software license agreement.