

# High Reliability, Military D Subminiature, & Non-Magnetic/No-Outgas

www.DataSheet4U.com

## Solder Cup

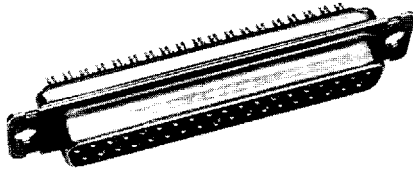

(See page 333)

## Crimp

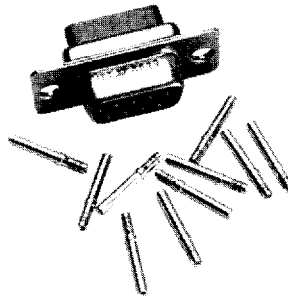

(See page 334-335)

## Printed Circuit

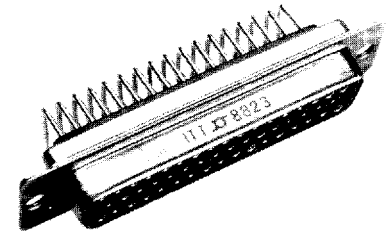

(See page 336-338)

## Performance and Material Specifications

### MATERIALS AND FINISHES

	Standard		Military	
	Material	Finish	Material	Finish
Shell	Steel per ASTM A-620	Yellow chromate over cadmium QQ-P-416 Type II Class 2	Steel per ASTM A-620	Yellow chromate over cadmium QQ-P-416 Type II Class 2
Insulator	Diallyl phthalate glass-filled per MIL-M-14, type SDG-F, color green	—	Diallyl phthalate glass-filled per MIL-M-14, type SDG-F, color green	—
Contact	Copper alloy	Gold over nickel	Copper alloy Crimp socket has stainless steel hood passivated.	Gold 50 microinches minimum thickness per MIL-G-45204 Type II Grade C Class 1 over copper per MIL-C-14550 Hood: Passivated
Float Mount Hardware	Stainless steel	Passivate per QQ-P-35	Stainless steel	Passivate per QQ-P-35

### PERFORMANCE SPECIFICATIONS

Wire Accommodation (AWG)	Solder - #20 Max. Crimp - #18-#30 Max.
Current Rating	#20; 5 Amp
Temperature Rating	-65°C to +150°C
Contact Resistance After Salt Spray, Millivolt Max.	55 @ 7.5 Amp test current

See pages 339 and 340 for complete M24308 cross reference.

### DIELECTRIC WITHSTANDING VOLTAGE

	90° and Straight (Solder/Crimp)			
	Altitude (feet/m)			
	Sea Level	20,000/6,096	50,000/15,240	70,000/21,336
Average Flashover	1700/1500	1000/1000	650/500	500/500
Test	1250/1000	750/650	475/325	375/325

All voltage figures are rms AC 60 rms cps, measured at approximately +25°C, 50% rh. For additional performance specifications refer to MIL-C-24308 Test Extracts on page 385.

## Non-Magnetic/No-Outgas Options

Suffix Code	Residual Magnetism	Shell Material (Finish)	Desired Results
NMB	200 Gamma Residual Magnetism Insulator. (Diallyl phthalate per MIL-M-14 type SDG-F, color white.)	Brass Shells Per QQ-B-613 (Yellow Chromate over Cadmium per QQ-P-416, Type II, Class 2.)	Non-Magnetic No-Outgas
NMB-K52	200 Gamma Residual Magnetism Insulator. (Diallyl phthalate per MIL-M-14 type SDG-F, color white.)	Brass Shells Per QQ-B-613 (Gold over Copper per MIL-G-45204, Type II, Grade C, Class 1 over copper per MIL-C-14550.)	Non-Magnetic No-Outgas

Note: Look for the **NM** symbol for ordering information.

## Contact Arrangements

### Face View Pin Insert

Shell Size  
Contact Arrangement  
Contact Size

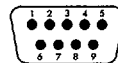

E  
9  
#20

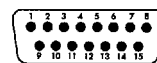

A  
15  
#20

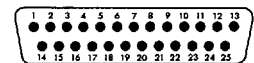

B  
25  
#20

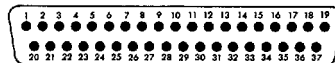

Shell Size  
Contact Arrangement  
Contact Size

C  
37  
#20

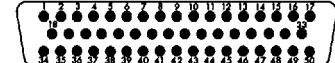

D  
50  
#20

www.DataSheet4U.com

## How to Order – High-Rel Printed Circuit Mount Connectors

**Straight PC Tail, Receptacles (Includes Socket Contacts) With .120 (3.15) Through-Mounting Holes**

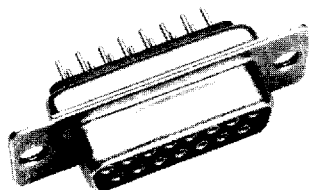

Number of Contacts (Shell Size)	PC Tails - .030 (0.76) Diameter			Wire Wrap Post - .024 (0.61) Square	
	.127 (3.23) ±.027 (0.69) Long Post	.158 (4.01) ±.027 (0.69) Long Post	.183 (4.65) ±.027 (0.69) Long Post	.405 (10.29) ±.027 (0.69) Long Post (Two Wrap)	.530 (13.46) ±.027 (0.69) Long Post (Three Wrap)
9 (E) Standard	DEM9SE	DEM9SM	DEM9SZ	DEM9SF179	DEM9SF179A
9 (E) Military	DEM9SE	DEM9SM	DEM9SZ	DEM9SF179	DEM9SF179A
15 (A) Standard	DAM15SE	DAM15SM	DAM15SZ	DAM15SF179	DAM15SF179A
15 (A) Military	DAMM15SE	DAMM15SM	DAMM15SZ	DAMM15SF179	DAMM15SF179A
25 (B) Standard	DBM25SE	DBM25SM	DBM25SZ	DBM25SF179	DBM25SF179A
25 (B) Military	DBMM25SE	DBMM25SM	DBMM25SZ	DBMM25SF179	DBMM25SF179A
37 (C) Standard	DCM37SE	DCM37SM	DCM37SZ	DCM37SF179	DCM37SF179A
37 (C) Military	DCMM37SE	DCMM37SM	DCMM37SZ	DCMM37SF179	DCMM37SF179A
50 (D) Standard	DDM50SE	DDM50SM	DDM50SZ	DDM50SF179	DDM50SF179A
50 (D) Military	DDMM50SE	DDMM50SM	DDM50SZ	DDMM50SF179	DDMM50SF179A

**NM** Non-Magnetic/No-Outgas – Add desired suffix code (NMB, NMB-K52) to end of part number. Example: DEM9SZNMB-K52

**Straight PC Tail, Plug (Includes Pin Contacts) With .120(3.15) Through-Mounting Holes**

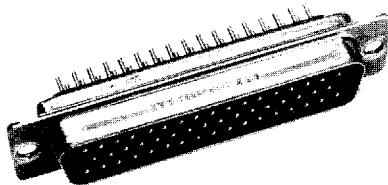

Number of Contacts (Shell Size)	PC Tails - .030 (0.76) Diameter			Wire Wrap Post - .024 (0.61) Square	
	.127 (3.23) ±.027 (0.69) Long Post	.158 (4.01) ±.027 (0.69) Long Post	.183 (4.65) ±.027 (0.69) Long Post	.405 (10.29) ±.027 (0.69) Long Post (Two Wrap)	.530 (13.46) ±.027 (0.69) Long Post (Three Wrap)
9 (E) Standard	DEM9PE	DEM9PM	DEM9PZ	DEM9PF179	DEM9PF179A
9 (E) Military	DEM9PE	DEM9PM	DEM9PZ	DEM9PF179	DEM9PF179A
15 (A) Standard	DAM15PE	DAM15PM	DAM15PZ	DAM15PF179	DAM15PF179A
15 (A) Military	DAMM15PE	DAMM15PM	DAMM15PZ	DAMM15PF179	DAMM15PF179A
25 (B) Standard	DBM25PE	DBM25PM	DBM25PZ	DBM25PF179	DBM25PF179A
25 (B) Military	DBMM25PE	DBMM25PM	DBMM25PZ	DBMM25PF179	DBMM25PF179A
37 (C) Standard	DCM37PE	DCM37PM	DCM37PZ	DCM37PF179	DCM37PF179A
37 (C) Military	DCMM37PE	DCMM37PM	DCMM37PZ	DCMM37PF179	DCMM37PF179A
50 (D) Standard	DDM50PE	DDM50PM	DDM50PZ	DDM50PF179	DDM50PF179A
50 (D) Military	DDMM50PE	DDMM50PM	DDMM50PZ	DDMM50PF179	DDMM50PF179A

**NM** Non-Magnetic/No-Outgas – Add desired suffix code (NMB, NMB-K52) to end of part number. Example: DEM9PZNMB-K52

## Dimensions

### Printed Circuit Applications

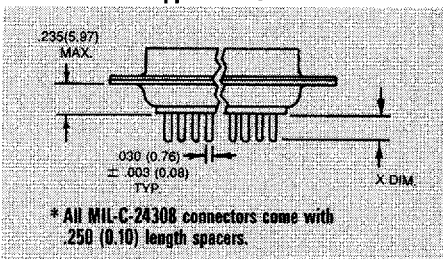

Code (Last Letter of Part Number)	Straight X ±.027 (0.69)
E	.127 (3.22)
M	.158 (4.01)
Z	.183 (4.65)

### Wire Wrapping Applications

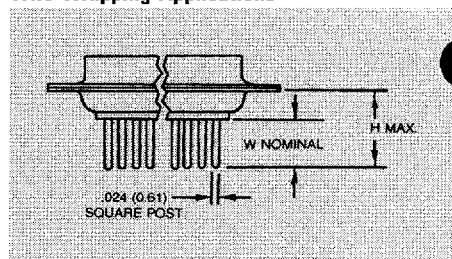

Modification Code	Number of Wraps	W	H
F179	2	.405 (10.29)	.655 (16.64)
F179A	3	.530 (13.46)	.780 (19.81)

## PC Board Hole Patterns

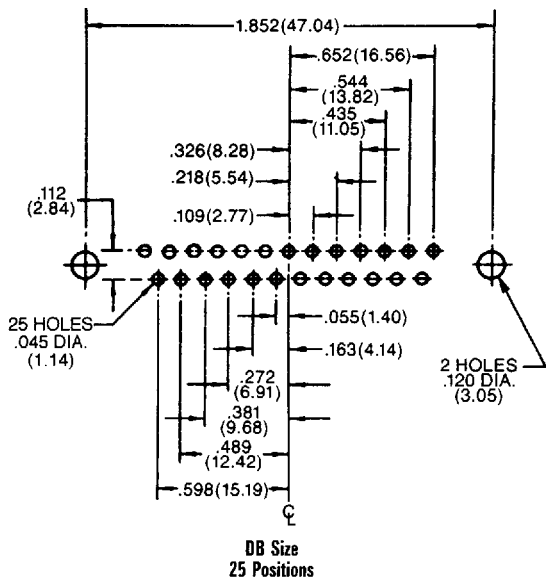
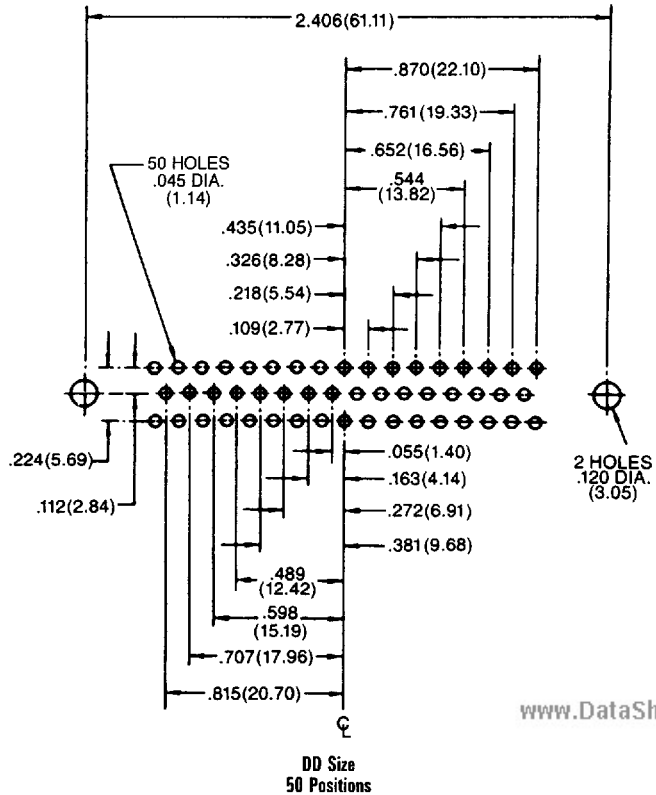
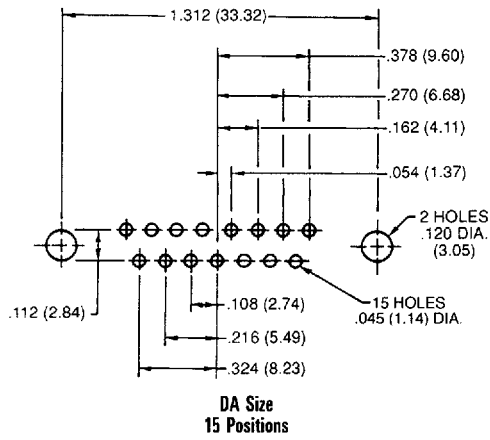
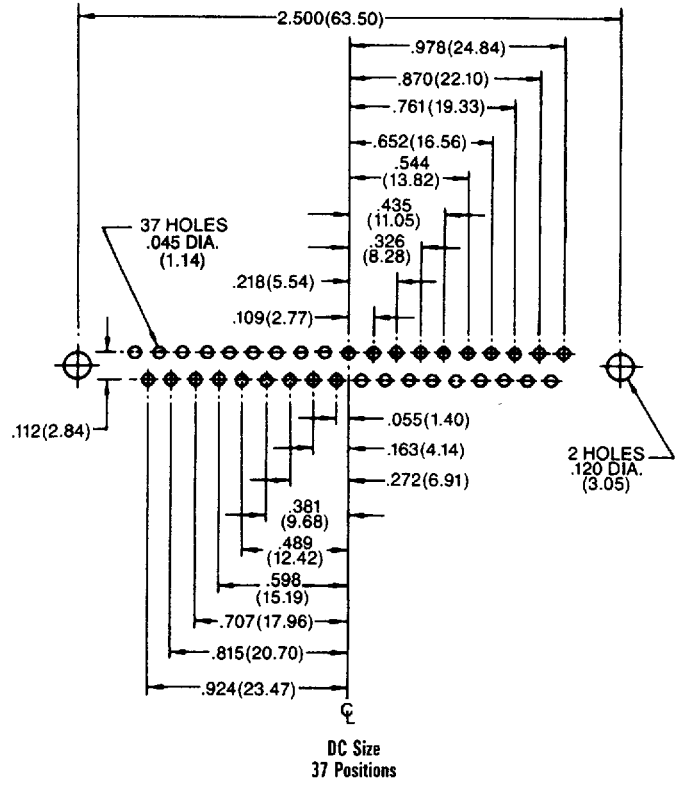
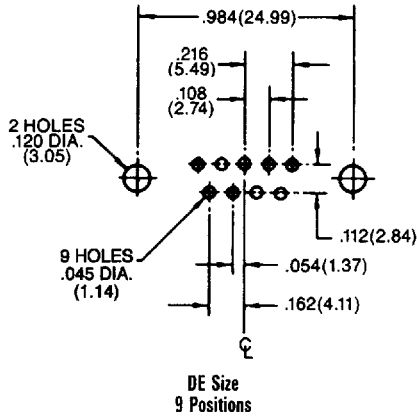

B Submitter