

**Maximum Ratings**

Symbol	Conditions	Values	Units
$V_{CEVsus}$	$I_C = 1\text{ A}, V_{BE} = -2\text{ V}$	1000	V
$V_{CEV}$	$V_{BE} = -2\text{ V}$	1000	V
$V_{CBO}$	$I_E = 0$	1000	V
$V_{EBO}$	$I_C = 0$	7	V
$I_C$	D. C.	50	A
$I_{CM}$	$t_p = 1\text{ ms}$	100	A
$I_F = -I_C$	D. C.	50	A
$I_B$		3	A
$P_{tot}$	$T_{case} = 25\text{ °C}$ , per darlington	400	W
$T_{vj}$		-40 ... +150	°C
$T_{stg}$		-40 ... +125	°C
$V_{isol}$	a. c. 50 Hz, r.m.s.	2500~	V

**Thermal Characteristics**

Symbol	Conditions	Values	Units
$R_{thjc}$	per darlington/per module	0,31/0,15	°C/W
$R_{thjc}$	per diode/per module	1,2/0,6	°C/W
$R_{thch}$	per 1/2 module/per module	0,15/0,075	°C/W

**Electrical Characteristics<sup>1)</sup>**

Symbol	Conditions	min.	typ.	max.	Units
$I_{CEV}$	$V_{CE} = V_{CEV}, V_{BE} = -2\text{ V}$			1	mA
$I_{EBO}$	$I_C = 0, V_{BE} = -7\text{ V}$			200	mA
$V_{CEsat}^{2)}$	$I_C = 50\text{ A}, I_B = 1\text{ A}$			2,5	V
$V_{BEsat}^{2)}$	$I_C = 50\text{ A}, I_B = 1\text{ A}$			3,5	V
$h_{21E}^{2)}$	$I_C = 50\text{ A}$	$V_{CE} = 2,8\text{ V}$	75		
		$V_{CE} = 5\text{ V}$	100		

**Switching Characteristics for Resistive Load<sup>1)</sup>**

Symbol	Conditions				Units
$t_{on}$	$I_C = 50\text{ A}$ $I_{B1} = -I_{B2} = 1\text{ A}$ $V_{CC} = 600\text{ V}$		0,8	2,5	µs
$t_s$			11	15	µs
$t_f$			2	3	µs

**Inverse Diode Characteristics<sup>1)</sup>**

Symbol	Conditions				Units
$V_F = -V_{CE}$	$I_F = -I_C = 50\text{ A}$			1,75	V
$I_{FSM} = -I_{CP}$	$\sin 180^\circ, 10\text{ ms}$	500			A
$I_{RM}$	$I_F = -I_C = 50\text{ A}, -di_F/dt = 100\text{ A}/\mu\text{s}$ $V_{BE} = -3\text{ V}, V_R = V_{CE} = 400\text{ V},$ $T_{vj} = 125\text{ °C}$		35		A
$Q_{rr}$			17		µC

**Mechanical Data**

Symbol	Description	SI units		US units	
		Value	Unit	Value	Unit
$M_1$	Case to heatsink	3	Nm	6	lb. in.
		27	lb. in.	53	lb. in.
$M_2$	Busbars to terminals	2,5	Nm	5	lb. in.
		22	lb. in.	44	lb. in.
$w$		250	g		
Case	DB	D 11			
	DAL	D 21			

<sup>1)</sup>  $T_{case} = 25\text{ °C}$  unless otherwise stated

<sup>2)</sup>  $t_p \leq 300\text{ µs}, D \leq 1,5\%$

**SEMITRANS® 2 NPN Power Darlington Modules**

50 A, 1000 V *T-33-35*

SK 50 DB 100 D  
SK 50 DAL 100 D

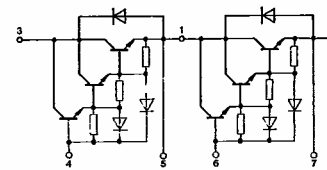
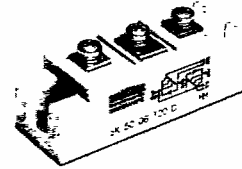

DB

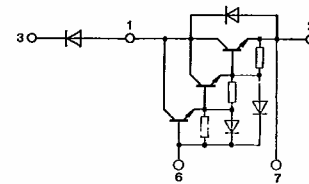

DAL

**Features**

- Isolated baseplate (ease of mounting of one or several modules on one heatsink)
- All electrical connections on top (ease of interconnecting of modules with busbars/PCB)
- Large clearances and creepage distances
- Parallel connected fast recovery inverse diode
- UL recognized, file no. 63 532

**Typical Applications**

- Switched mode power supplies
- DC servo and robot drives
- AC motor controls
- Brake choppers (DAL)

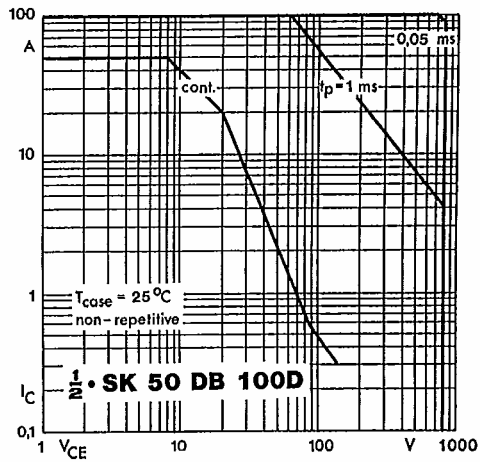

Fig. 1 Forward biased safe operating area (FBSOA)

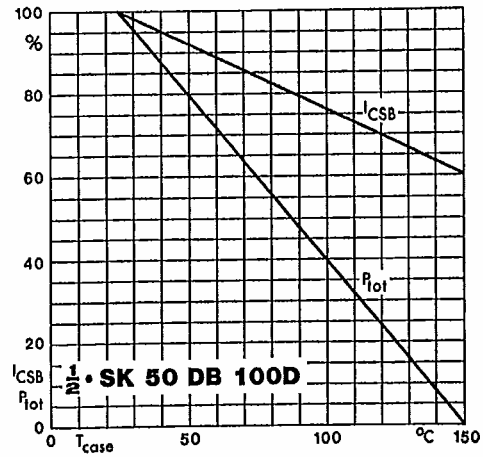

Fig. 2 Shifting the limits of the FBSOA with temperature

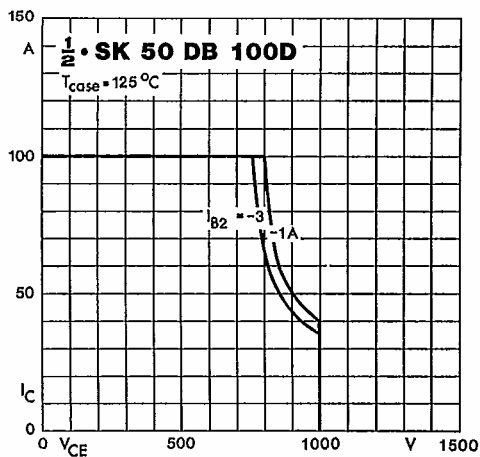

Fig. 3 Reverse biased safe operating area (RBSOA)

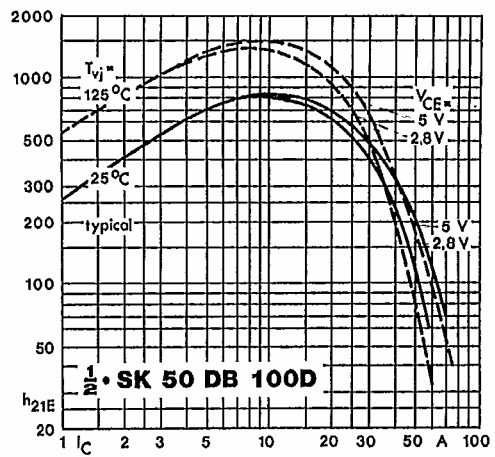

Fig. 4 Forward current transfer ratio vs. coll. current

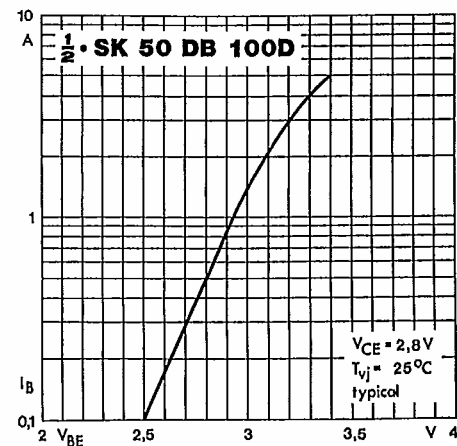

Fig. 5 Base current/voltage characteristic

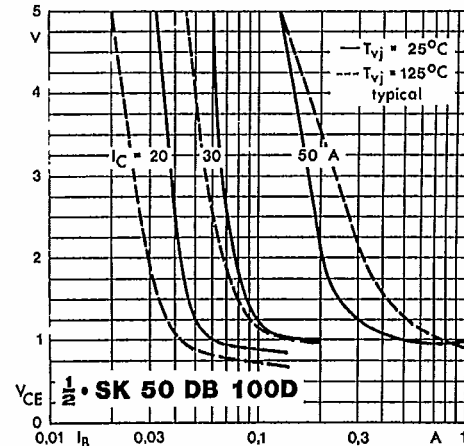

Fig. 6 Collector-emitter voltage vs. base current

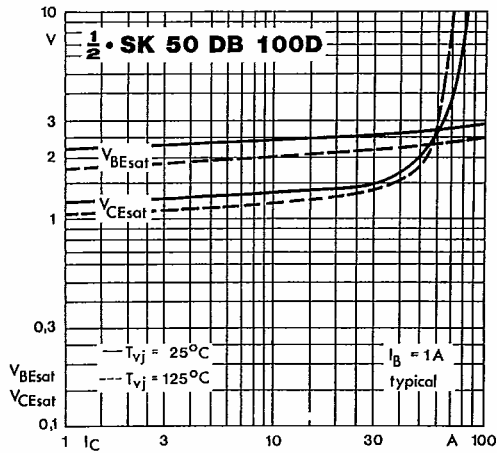

Fig. 7 Saturation voltages vs. collector current

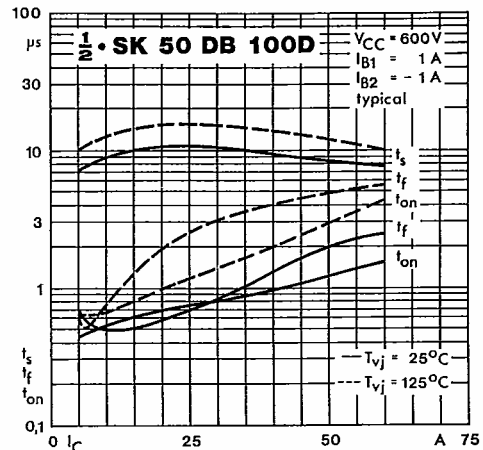

Fig. 8 Switching times vs. collector current

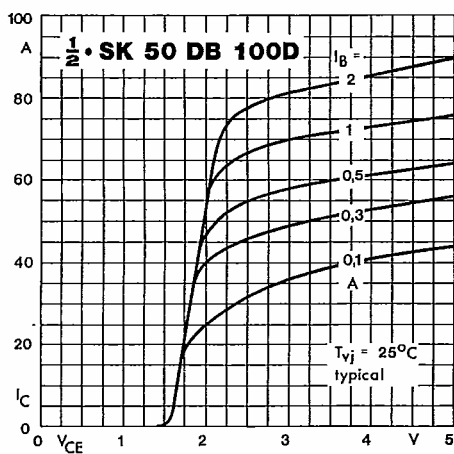

Fig. 9 Collector current/voltage characteristics

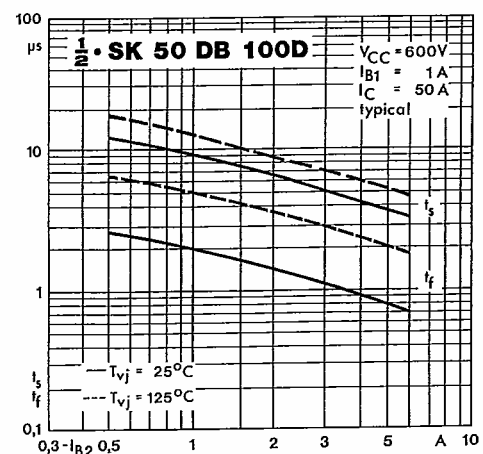

Fig. 10 Turn-off times vs. negative base current

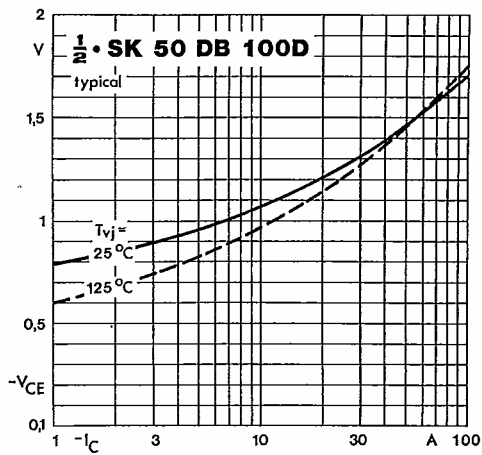

Fig. 11 Inverse diode forward characteristics

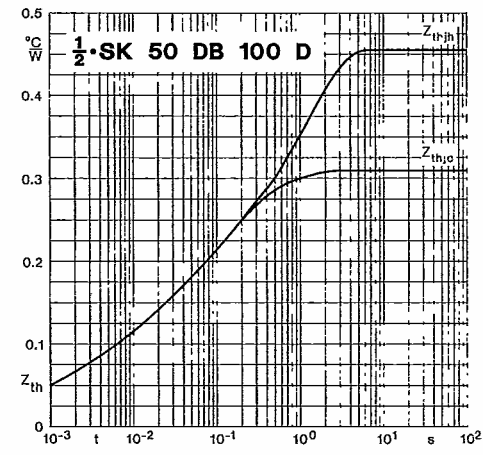

Fig. 12 Transient thermal impedance vs. time

**SK 50 DB 100 D**

Case D 11

SEMITRANS® 2

UL recognized, file no. E 63 532

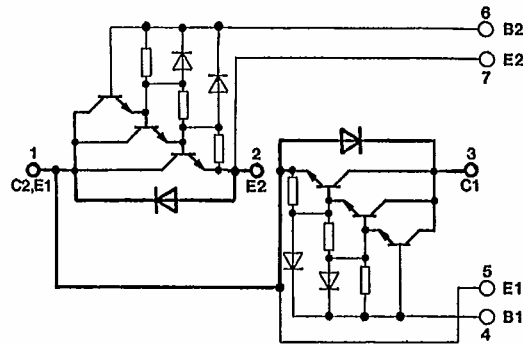
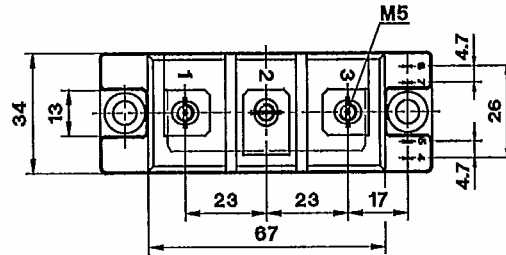
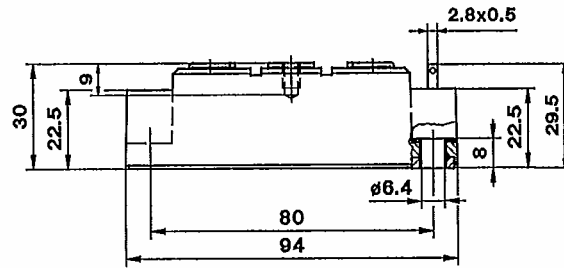

Dimensions in mm

**SK 50 DAL 100 D**

Case D 21

SEMITRANS® 2

UL recognized, file no. 63 532

