

TOSHIBA PHOTOINTERRUPTER INFRARED LED + PHOTOTRANSISTOR

TLP1242(C6)

COPIER, PAGE PRINTER, FACSIMILE
 FAN-HEATER, AIR CONDITIONER
 TERMINAL EQUIPMENT IN BANKING FACILITIES
 GAME MACHINE

TLP1242(C6) is a compact photointerrupter with attached connector which uses a high-radiant power GaAs infrared LED and a Si photo-transistor. TLP1242(C6) is a photointerrupter in highly reliable package which eliminates the need for printed circuit board and soldering. It is optimum as a paper carrier location sensor for copiers and page printers. Operating temperature is up to 95°C. Thus the device can be used for high-temperature applications like paper-out sensors or air direction for air conditioner louvers. Open collector outputs are enabled using a phototransistor.

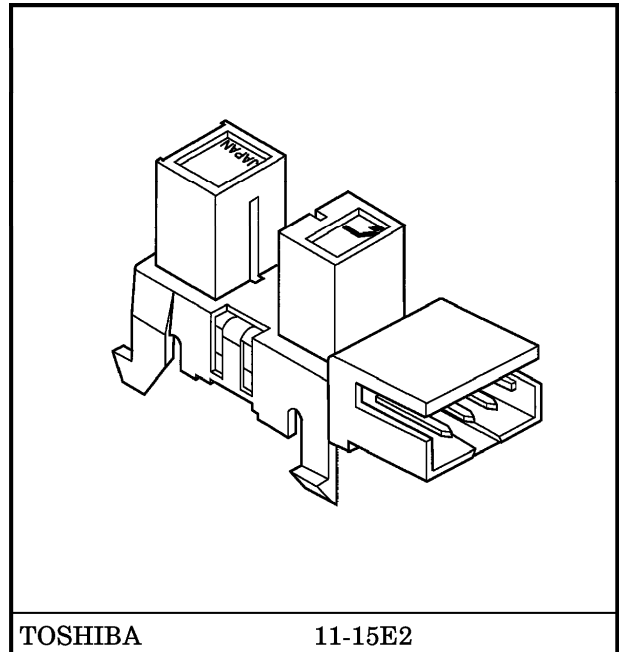

TOSHIBA

11-15E2

Weight : 1.3 g (Typ.)

- High reliability package (PWBless, Solderingless)
- Small package
- Mountable by one touch (Snap-in mounting type)
- Mountable to boards in 3 kinds of thickness (1.0 mm, 1.2 mm, 1.6 mm)
- Gap : 5 mm
- Resolution : Slit width 0.5 mm
- High temperature operating : $T_{opr} = 95^{\circ}\text{C}$ (Max.)
- High current transfer ratio : $I_C / I_F = 5\%$ (Min.)
- Connected to the CT connector (2 mm pitch MT receptacle type, MT crimp receptacle type II) made by AMP (Japan), Ltd.
- Material of the case : Body Polycarbonate (UL94V-2, Black)
 : Connector .. 66 nylon (UL94V-0, White)

980910EBC2

- TOSHIBA is continually working to improve the quality and the reliability of its products. Nevertheless, semiconductor devices in general can malfunction or fail due to their inherent electrical sensitivity and vulnerability to physical stress. It is the responsibility of the buyer, when utilizing TOSHIBA products, to observe standards of safety, and to avoid situations in which a malfunction or failure of a TOSHIBA product could cause loss of human life, bodily injury or damage to property. In developing your designs, please ensure that TOSHIBA products are used within specified operating ranges as set forth in the most recent products specifications. Also, please keep in mind the precautions and conditions set forth in the TOSHIBA Semiconductor Reliability Handbook.
- Gallium arsenide (GaAs) is a substance used in the products described in this document. GaAs dust and fumes are toxic. Do not break, cut or pulverize the product, or use chemicals to dissolve them. When disposing of the products, follow the appropriate regulations. Do not dispose of the products with other industrial waste or with domestic garbage.
- The products described in this document are subject to the foreign exchange and foreign trade laws.
- The information contained herein is presented only as a guide for the applications of our products. No responsibility is assumed by TOSHIBA CORPORATION for any infringements of intellectual property or other rights of the third parties which may result from its use. No license is granted by implication or otherwise under any intellectual property or other rights of TOSHIBA CORPORATION or others.
- The information contained herein is subject to change without notice.

1999-06-21 1/8

PRODUCT INDICATION

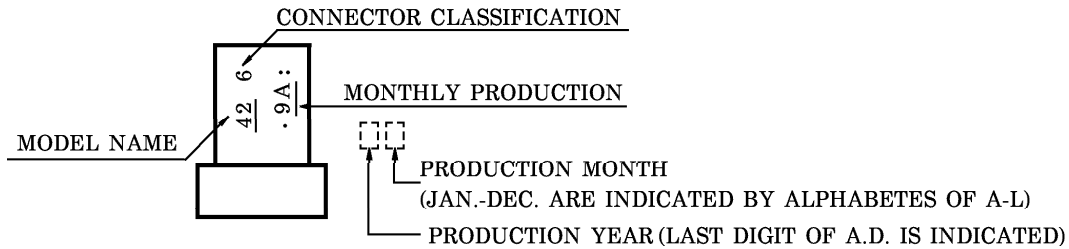

MAXIMUM RATINGS (Ta = 25°C)

CHARACTERISTIC		SYMBOL	RATING	UNIT
Forward Current		I_F	50	mA
Forward Current Derating	(Ta > 25°C)	$\Delta I_F / ^\circ C$	-0.33	mA / °C
	(Ta > 85°C)		-2	
Reverse Voltage		V_R	6	V
Collector-Emitter Voltage		V_{CEO}	35	V
Emitter-Collector Voltage		V_{ECO}	5	V
Collector Power Dissipation		P_C	75	mW
Collector Power Dissipation Derating (Ta > 25°C)		$\Delta P_C / ^\circ C$	-1	mW / °C
Collector Current		I_C	50	mA
Operating Temperature Range		T_{opr}	-30~95	°C
Storage Temperature Range		T_{stg}	-40~100	°C

OPTO-ELECTRICAL CHARACTERISTICS (Ta = 25°C)

CHARACTERISTIC		SYMBOL	TEST CONDITION	MIN.	TYP.	MAX.	UNIT
LED	Forward Voltage	V_F	$I_F = 10 \text{ mA}$	1.00	1.15	1.30	V
	Reverse Current	I_R	$V_R = 5 \text{ V}$	—	—	10	μA
	Peak Emission Wavelength	λ_P	$I_F = 10 \text{ mA}$	—	940	—	nm
DETECTOR	Dark Current	$I_D (I_{CEO})$	$V_{CE} = 24 \text{ V}, I_F = 0$	—	0.001	0.1	μA
	Peak Sensitivity Wavelength	λ_P		—	870	—	nm
COUPLED	Current Transfer Ratio	I_C / I_F	$V_{CE} = 2 \text{ V}, I_F = 10 \text{ mA}$	5	—	100	%
	Collector-Emitter Saturation Voltage	$V_{CE} (\text{sat})$	$I_F = 20 \text{ mA}, I_C = 0.5 \text{ mA}$	—	0.1	0.35	V
	Rise Time	t_r	$V_{CC} = 5 \text{ V}, I_C = 1 \text{ mA}, R_L = 1 \text{ k}\Omega$	—	15	50	μs
	Fall Time	t_f		—	15	50	

TERMINAL STRENGTH (Ta = 25°C)

CHARACTERISTIC		TEST CONDITION		LIMIT
TERMINAL STRENGTH	PULL	DIRECTION	A	NO DEFECT OF ELECTRICAL CHARACTERISTICS
		WEIGHT	19.6 N	
		TIME	5 s / ONCE	
	BEND	DIRECTION	B	
		WEIGHT	9.8 N	
		TIME	5 s / THRICE	

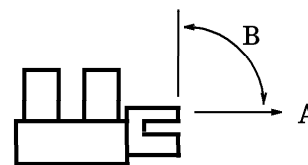

MATCHED CONNECTOR

AMP (Japan), Ltd. made CT connector (2 mm pitch MT receptacle type)

HOUSING-TERMINAL EN BLOCK TYPE	TYPE No.	TERMINAL MATERIAL	AWG SIZE	INSULATION DIAMETER
	173977-3	PHOSPHOR BRONZE	AWG26~28	0.85~1.05 mm

AMP (Japan), Ltd. made CT connector (2 mm pitch MT crimp receptacle type II)

HOUSING	179228-3				
TERMINAL	TYPE No.	PRODUCT FORM	MATERIAL	AWG SIZE	INSULATION DIAMETER
	179518-1	LOOSEN	PHOSPHOR BRONZE	AWG22~26	0.93~1.5 mm
	179227-1	LINKED			

For details of the matched connectors, please refer to the connector maker.

PRECAUTION

- A visible light cut-off type phototransistor which blocks light with frequencies of 700 nm or less is used.
However, the device cannot block ambient light with a wave length of 700 nm or more, or sunlight. Install avoiding interference from external light.
- The environment to install the device should be determined carefully. Oil or chemicals may cause the package to be dissolved or cracked.
- When installing, avoid to work by holding the connector by hand. Always, install by holding the main body of the device while assuring the metal board is not warped or twisted. The connectors shall be inserted or pulled out at normal temperature.
- It is recommended to mount this product by inserting from the metal board pressed side.
- We recommend checking the strength of the mounting on metal board by mounting the device in advance.
- Do not solder to the pins of the connector block. Use the matched connector.
- When connecting/disconnecting the connector, hold the matched connector and power line in parallel to the TLP1242 pins. Pushing or pulling diagonally may damage the connector block or degrade the connection.
- Conversion efficiency drops with time due to current to infrared LED.
Design the circuit taking the time change in conversion efficiency into consideration.
Fluctuation of conversion efficiency versus fluctuation of optical output of infrared LED is 1 : 1.

$$\frac{I_C / I_F(t)}{I_C / I_F(0)} = \frac{P_O(t)}{P_O(0)}$$

OUTLINE : TOSHIBA 11-15E2

Unit in mm

() : REFERENCE VALUE

UNLESS OTHERWISE SPECIFIED

DIMENSION	TOLERANCE
6 >	± 0.1
6 < 14	± 0.2

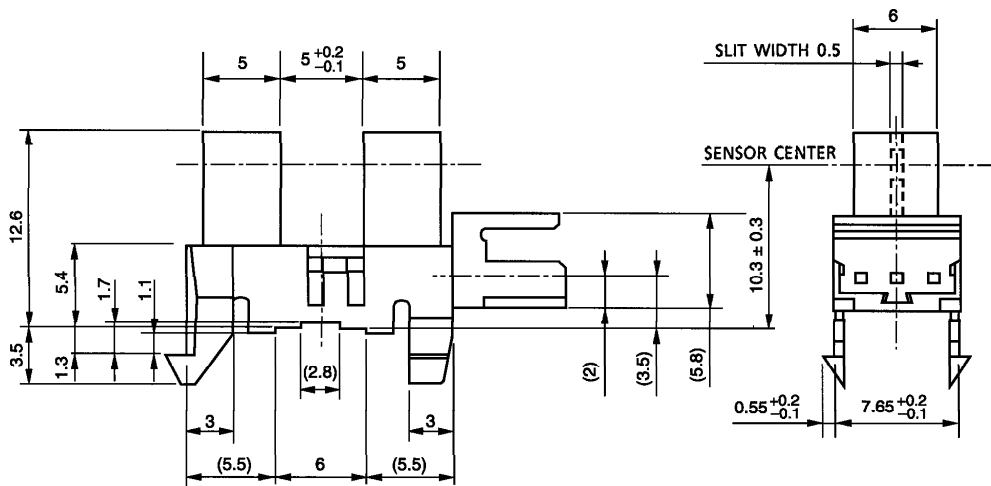
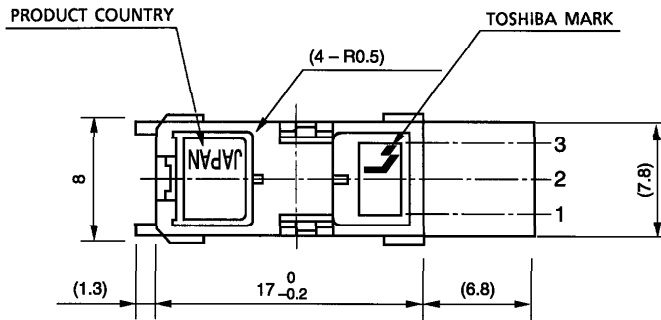

Weight : 1.3 g (Typ.)

PIN CONNECTION

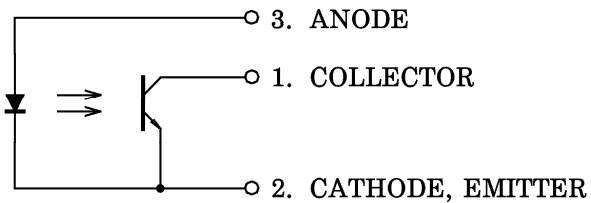

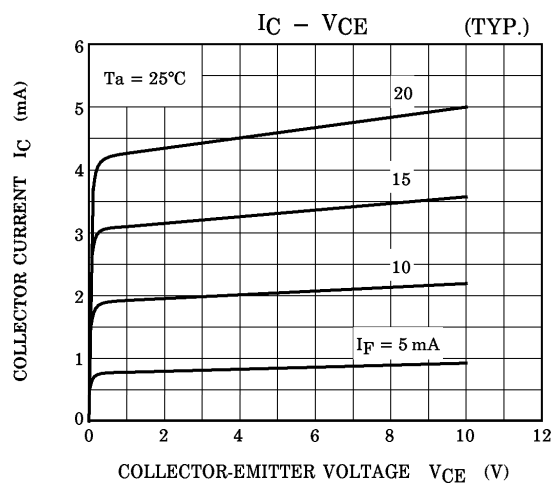
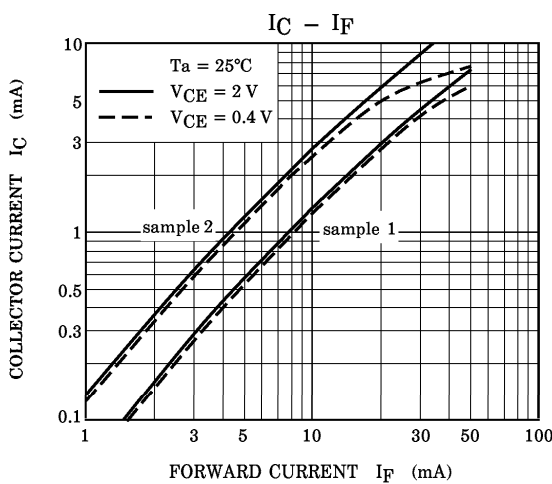
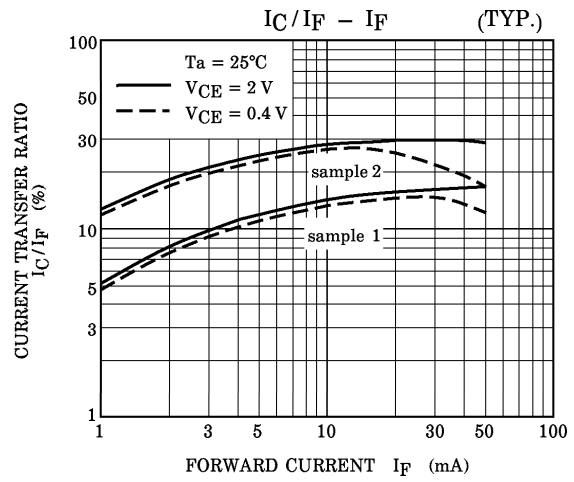
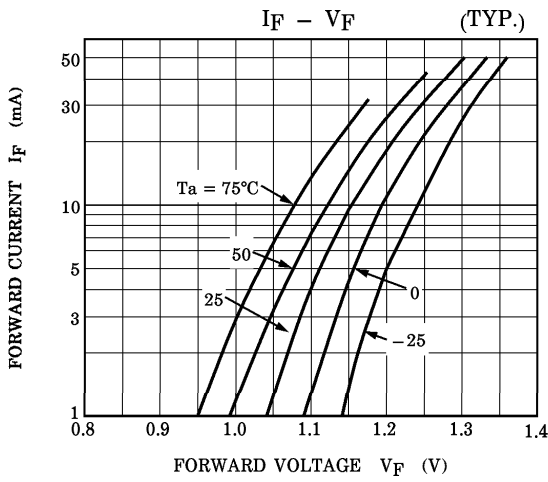
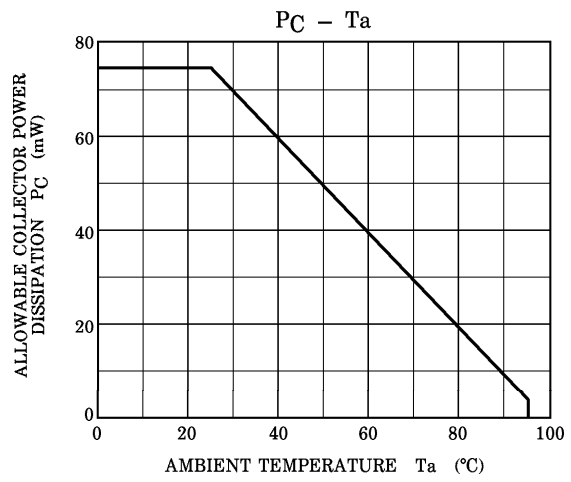
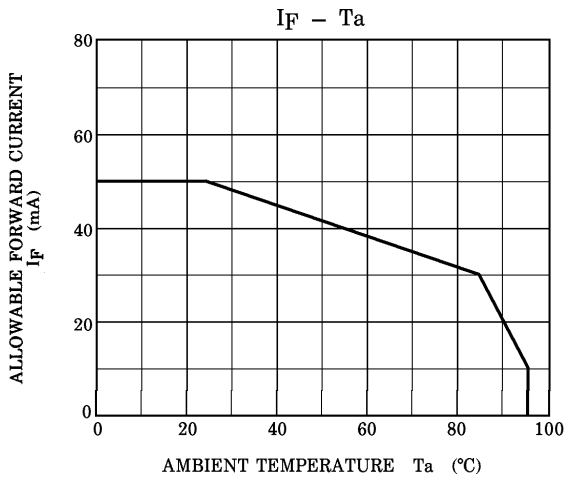

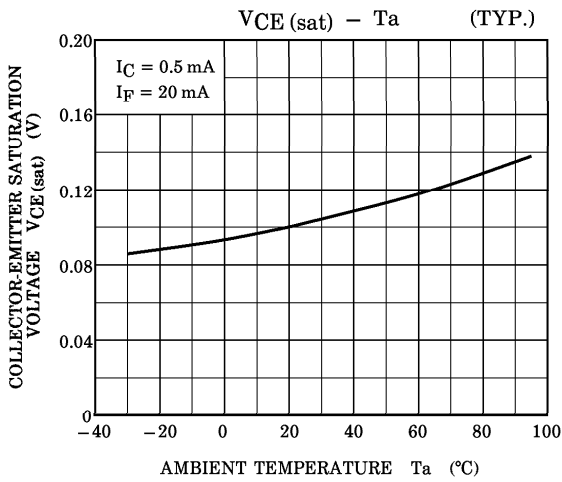
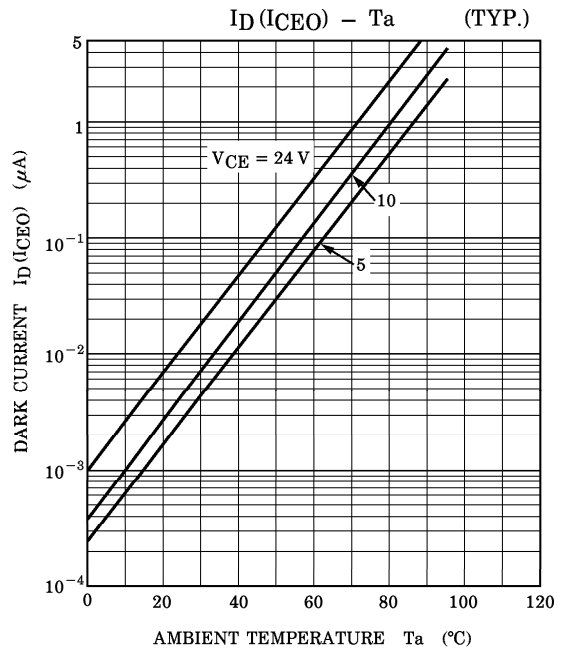
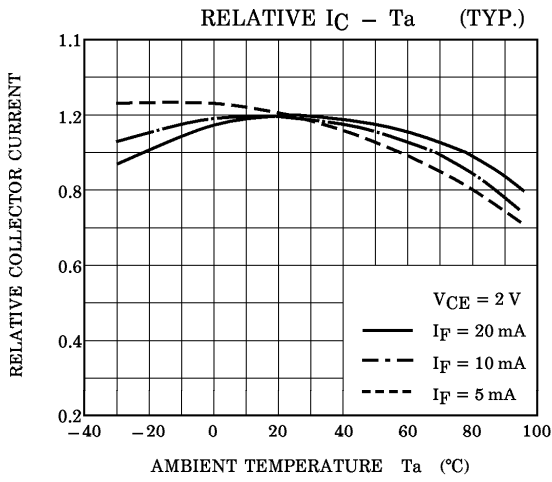

SWITCHING TIME TEST CIRCUIT

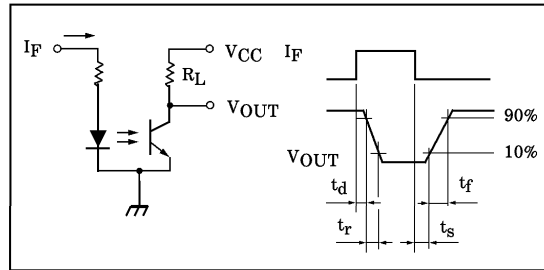

SWITCHING CHARACTERISTICS (NON SATURATED OPERATION) (TYP.)

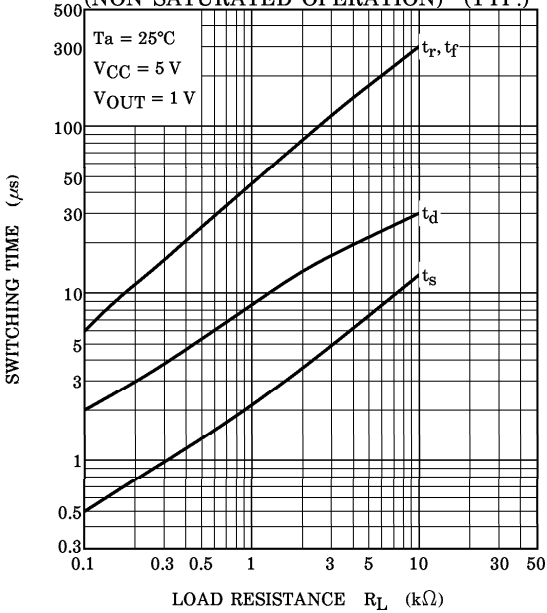

SWITCHING CHARACTERISTICS (SATURATED OPERATION) (TYP.)

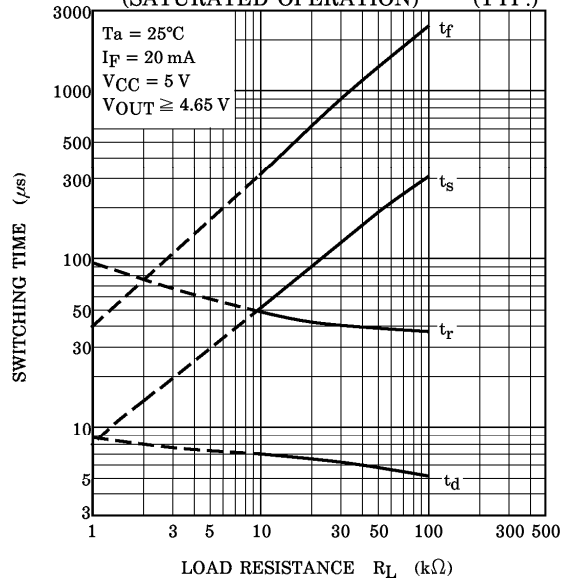

DETECTING POSITION CHARACTERISTICS (1) (TYP.)

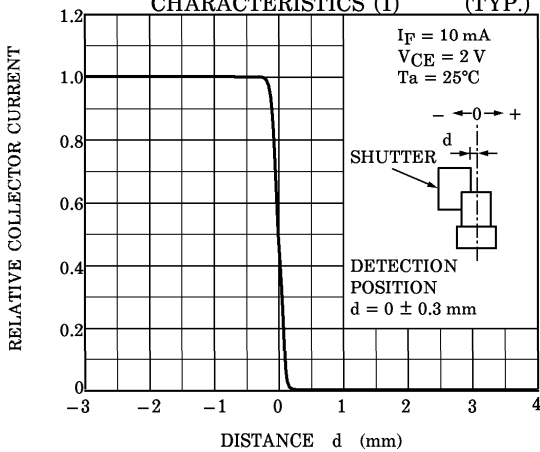

DETECTING POSITION CHARACTERISTICS (2) (TYP.)

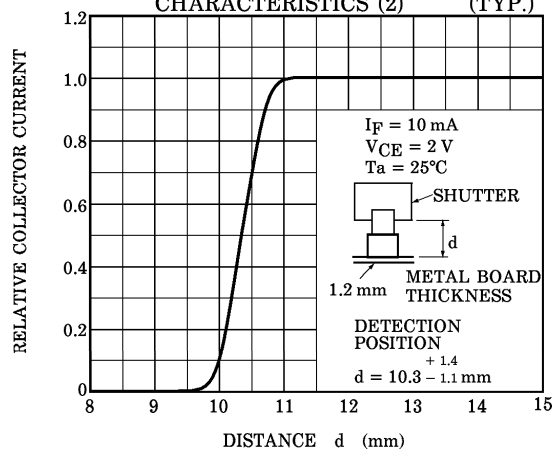

POSITIONING OF SHUTTER AND DEVICE

To operate correctly, make sure that the shutter and the device are positioned as shown in the figure below.

The slit pitch of the shutter must be set wider than the slit width of the device.
Determine the width taking the switching time into consideration.

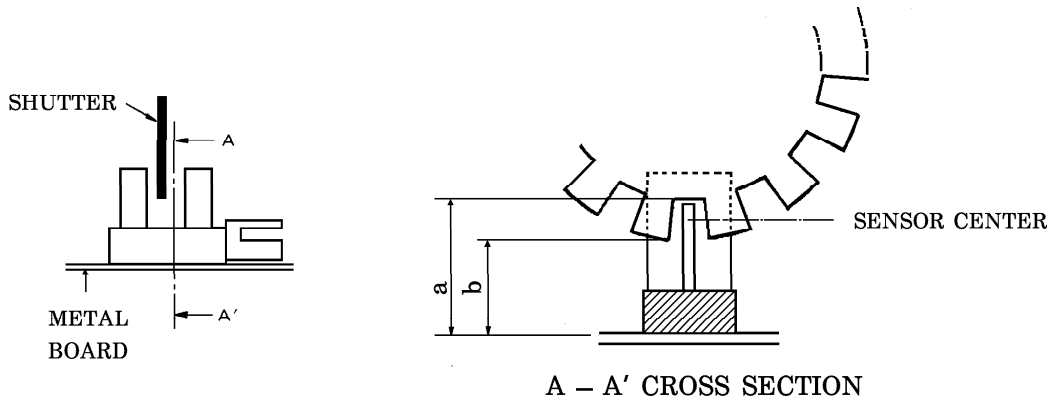

Unit : mm

METAL BOARD THICKNESS	a SIZE	b SIZE
1.0	11.9 MIN.	9.4 MAX.
1.2	11.7 MIN.	9.2 MAX.
1.6	11.3 MIN.	8.8 MAX.

RECOMMENDED MOUNTING HOLE (Unit : mm)

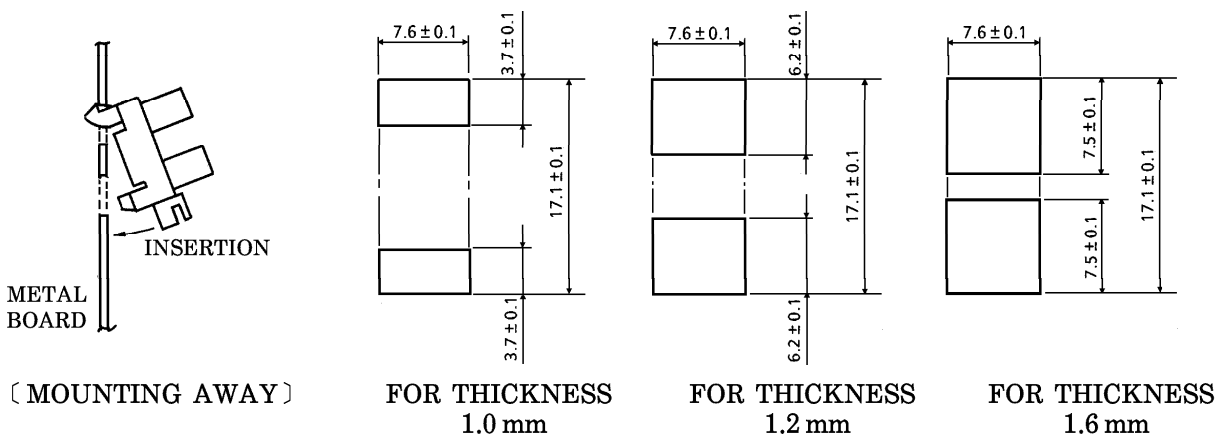

When mounting on other than metal board as shown above, contact TOSHIBA.