

FAST TURN-OFF ASYMMETRICAL THYRISTOR

ACR 22U
 $I_T(AV) = 22A$
 $t_q = 5.5\mu s$

VOLTAGE RATINGS	Repetitive peak voltages		Crest (peak) working voltages	
	V_{DRM}	V_{RRM}	V_{DWM}	V_{RWM}
ACR22U04LG	400	10	400	10
ACR22U06LG	600	10	600	10
ACR22U08LG	800	10	800	10
ACR22U10LG	1000	10	1000	10
ACR22U12LG	1200	10	1200	10

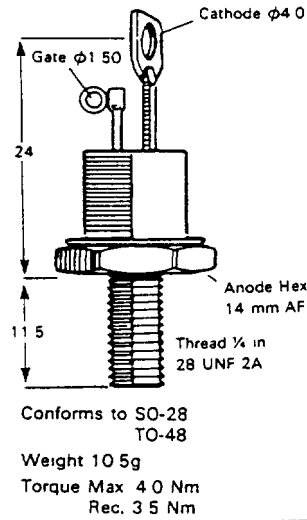

Applications

- High frequency inverters
- Regulated Power Supplies
- Cycloconverters
- Ultrasonic Generators
- Induction Heaters
- Electronic Welding

Features

The ACR22U is a glass passivated asymmetrical thyristor. This device has exceptionally fast turn-off capabilities combined with good turn-on characteristics.

Current Ratings

Symbol	Description	Conditions	Units
$I_T(AV)$	Mean on-state current	Half wave resistive load $T_{case} = 70^\circ C$	22 A
I_T	Continuous (direct) on-state current	$T_{case} = 85^\circ C$	22A
I_{RMS}	RMS value	Max value	35A

Surge Ratings

I_{TSM}	Surge (non-repetitive) on-state current	$T_j = 125^\circ C$	220 A
I^2t	I^2t for fusing	10ms half sine	242 A ² s
di/dt	Rate of rise of on-state current	From V_{DRM} to 125A, Gate source 15V, 15Ω, rise time, 50ns	2000 A/μs
dv/dt	Min linear rate of rise of off-state voltage	Gate open circuit $T_{case} = 125^\circ C$	†500V/μs

†Available up to 1000V/μs

Gate Ratings

V_{FGM}	Peak forward gate voltage	40 V
V_{RGM}	Peak reverse gate voltage	10 V
I_{FGM}	Peak forward gate current	10 A
P_{GM}	Peak gate power	40 W
P_G	Mean gate power	Forward = 10W Reverse = 6W

Averaging time = 10ms max.

Temperature & Frequency Ratings

T_{vj}	Virtual junction temperature	125°C
T_{sig}	Store temperature range	-55 to 125°C

Characteristics $T_{case} = 25^\circ C$ unless otherwise stated

V_{TM}	On-state voltage	$I_T = 100A$	Fig. 5
I_{DM}	Peak off-state current	$T_{case} = 125^\circ C @ V_{DRM}$	
I_{RM}	Peak reverse current	$T_{case} = 125^\circ C @ V_{RRM}$	Fig. 6
I_L	Latching current		
I_H	Holding current		
I_{GT}	Gate trigger current	$V_{DWM} = 12V, R_L = 30\Omega$	
V_{GT}	Gate trigger voltage	$V_{DWM} = 12V, R_L = 30\Omega$	
t_d	Delay time	$V_D = 300V$, gate source = 15V, 15Ω	
t_q	Circuit commutated turn-off time	$I_T = 50A$ sq. wave 50μs pulse, $T_c = 120^\circ C$, $di/dt = 50A/\mu s$, $dv/dt = 600V/\mu s$ to V_{DRM}	
$R_{th(j-h)}$	Thermal resistance	Gate voltage at turn-off > -1V Mounting torque 3.5 Nm (with mounting grease)	

LIMIT			
Min	Typ.	Max	Units
-	-	2.7	V
-	-	10	mA
-	-	10	mA
-	45	-	mA
-	35	-	mA
-	60	200*	mA
-	0.9	3	V
-	-	250	ns
-	-	5.5	μs
-	-	1.05	°C/W

*Recommended gate source is 15V, 15Ω with 50ns rise time or minimum gate current 500mA

ACR 22U

$I_T(AV) = 22A$

$t_q = 5.5\mu s$

Fig. 5.
ON-STATE CHARACTERISTICS

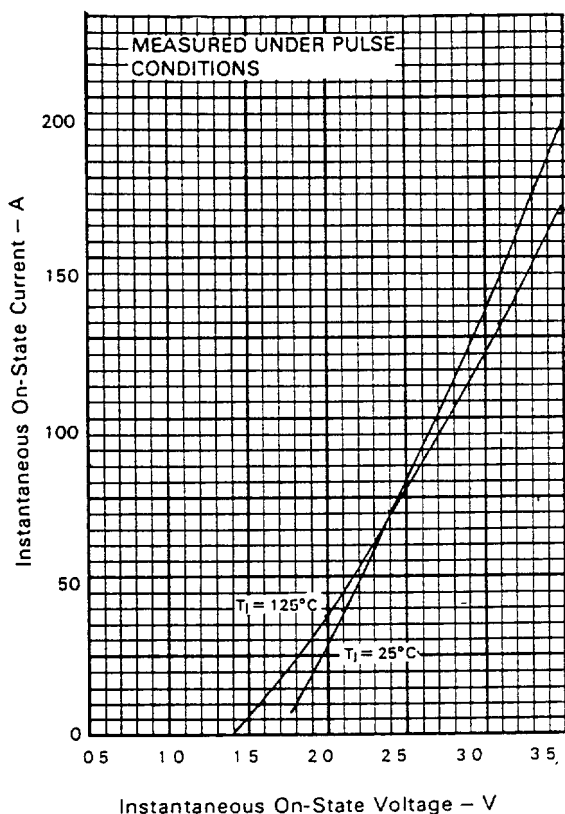

Fig. 6. TYPICAL CIRCUIT COMMUTATED TURN-OFF TIME VS. GATE VOLTAGE AT TURN-OFF

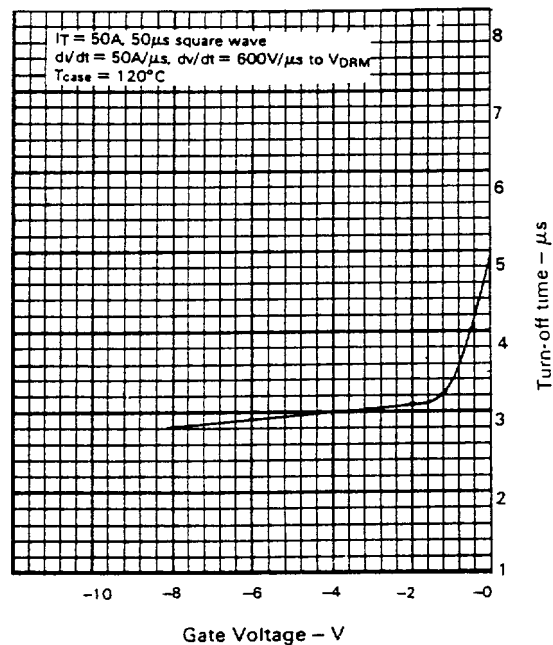
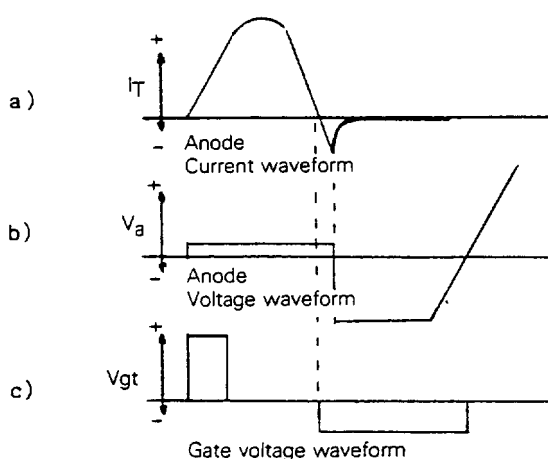
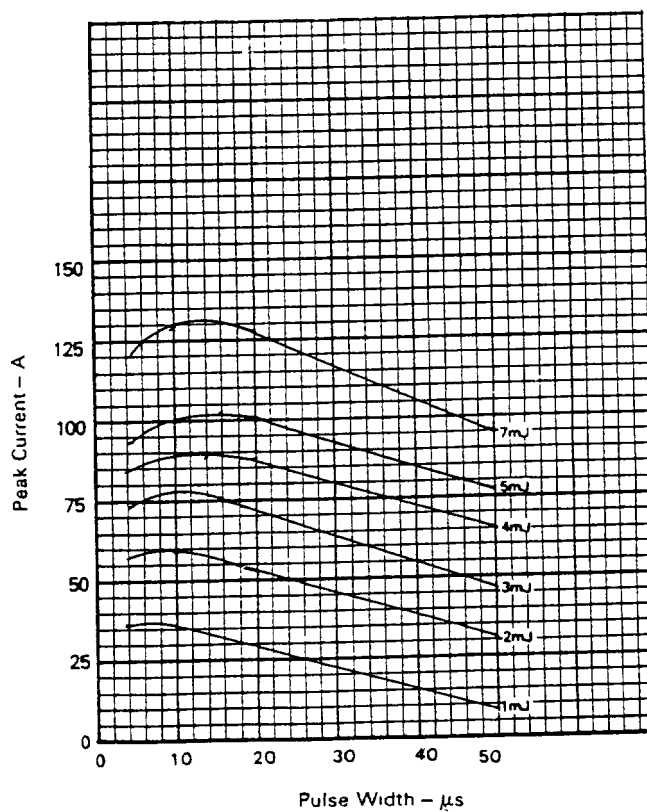

Fig. 7 MAXIMUM ENERGY LOSS/PULSE WHEN SWITCHING A HALF SINUSOIDAL PULSE FROM 600V



WAVEFORM OF GATE VOLTAGE AT TURN-OFF



ACR 22U

$I_T(AV) = 22A$

$t_q = 5.5\mu s$

Fig. 1 MINIMUM LINEAR CRITICAL RATE OF RISE OF OFF-STATE VOLTAGE VS GATE VOLTAGE

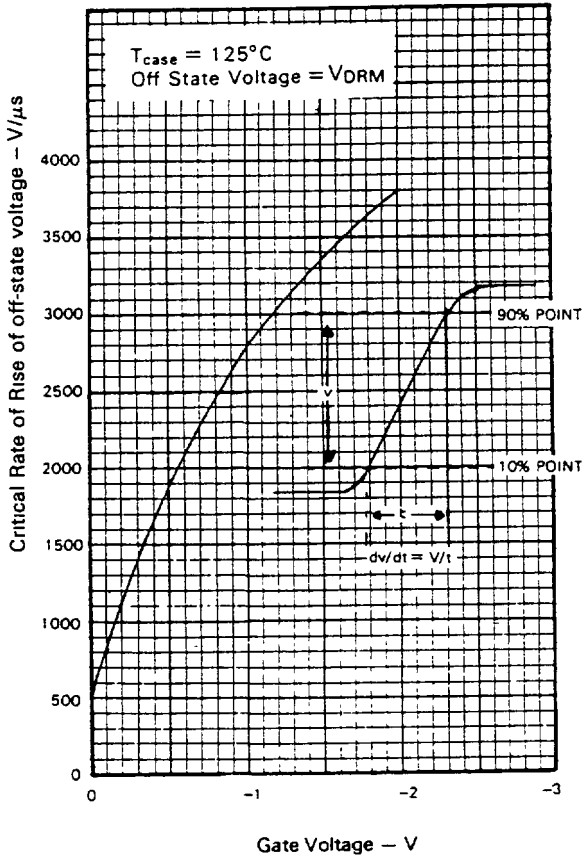

Fig. 3 REVERSE GATE CHARACTERISTICS

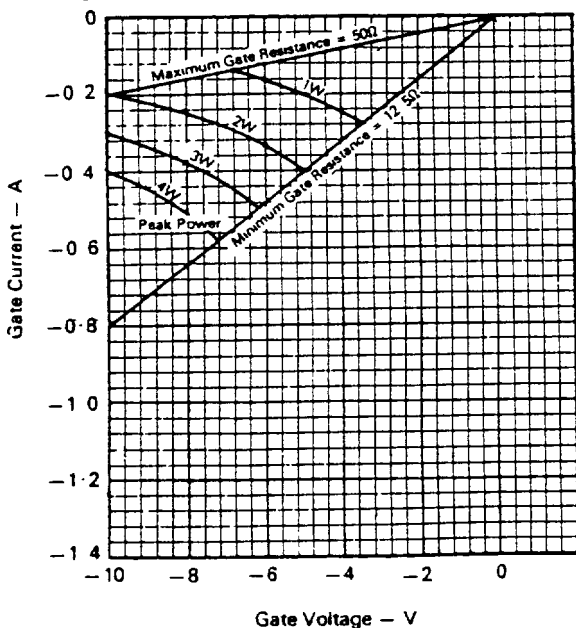

Fig. 2. GATE CHARACTERISTICS

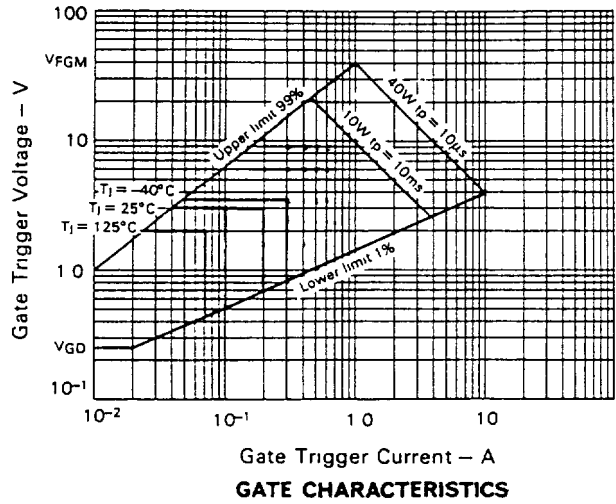
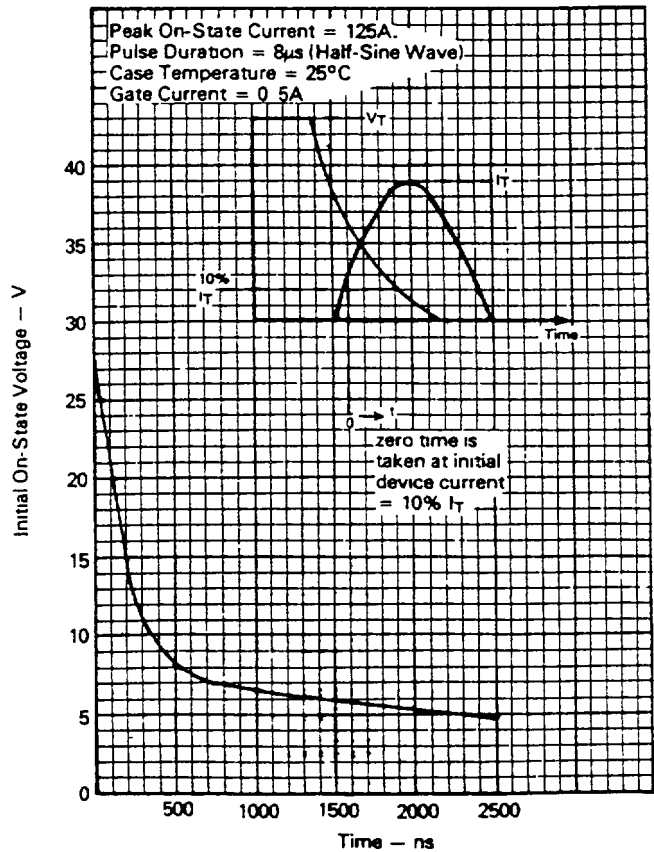

Fig. 4. TYPICAL INITIAL ON-STATE VOLTAGE VS TIME



**Marconi Electronic Devices Ltd.,
Power Semiconductor Division**

Carholme Road
Lincoln LN1 1SG

Telephone (0522) 510500 Telex 56163 Fax 0522 510550

P27 Issue 2 5/88

The information presented herein is to the best of our knowledge true and accurate. No warranty or guarantee, express or implied is made regarding the capacity, performance or suitability of any product.

You are strongly urged to ensure that the information given has not been superseded by a more up-to-date version.
All our products and materials are sold subject to our Conditions of Sales available on request.