

Features

- Colorless transparency lens type
- Using a package with high heat dissipation properties, it can be driven with a large current
- Wide viewing angle
- External dimensions : 3.5(L)×2.8(W)×1.9mm(T) surface mount type

Applications

- Backlighting
- Signal indicator
- Symbol backlighting
- Front panel indicator

Outline Dimensions

unit : mm

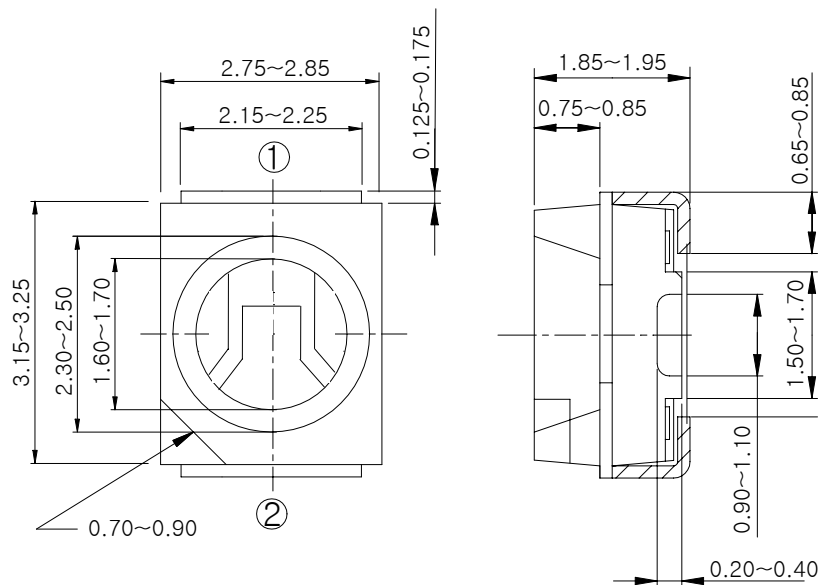

PIN Connections

1. Anode
2. Cathode

Absolute Maximum Ratings

(Ta=25°C)

Characteristic	Symbol	Rating	Unit
Power dissipation	P _D	70	mW
Forward current	I _F	30	mA
*1Peak forward current	I _{FP}	50	mA
Reverse voltage	V _R	5	V
Operating temperature range	T _{opr}	-40 ~ 100	°C
Storage temperature range	T _{stg}	-40 ~ 110	°C
*2Soldering temperature	T _{sol}	240°C for 10 seconds	

*1.Duty ratio = 1/16, Pulse width = 0.1ms

*2. Recommended reflow soldering temperature profile

- Preheating 150°C to 185°C within 120 seconds soldering 240°C within 10 seconds
- Gradual cooling (Avoid quenching)

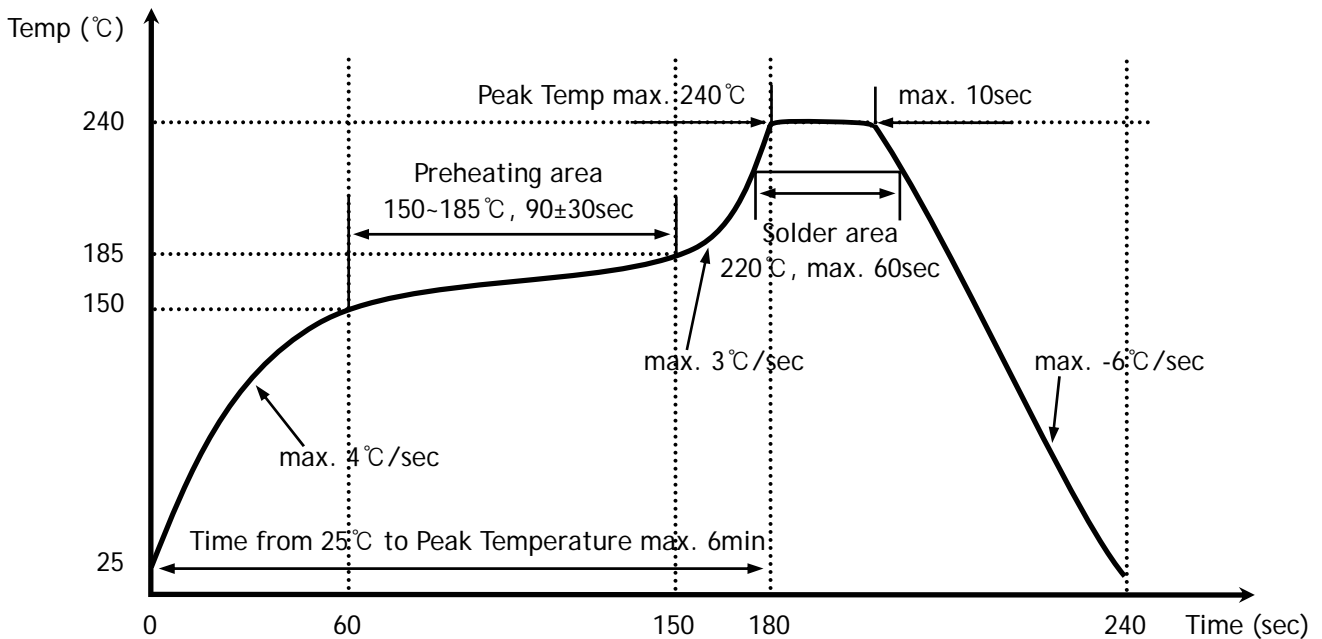

Electrical / Optical Characteristics

(Ta=25°C)

Characteristic	Symbol	Test Condition	Min	Typ	Max	Unit
Forward voltage	V _F	I _F = 20mA	1.85	-	2.3	V
*3Luminous intensity	I _V	I _F = 20mA	220	-	410	mcd
Dominant wavelength	λ _D	I _F = 20mA	600	604	608	nm
Spectrum bandwidth	Δλ	I _F = 20mA	-	35	-	nm
Reverse current	I _R	V _R =5V	-	-	10	μA
*4Half angle	θ1/2	I _F = 20mA	-	±60	-	deg

- *4. Luminous intensity maximum tolerance for each grade classification limit is $\pm 18\%$
(The test result of $I_F=20\text{mA}$ is only for reference)
- *5. $\theta_{1/2}$ is the off-axis angle where the luminous intensity is 1/2 the peak intensity

- V_F / I_V Grade Classification ($T_a=25^\circ\text{C}$)

Test Condition @ $I_F=20\text{mA}$	
Forward Voltage [V]	Luminous Intensity [mcd]
1 : 1.85~2.1	N : 220~310
2 : 2.1~2.3	O : 310~410

(Do not use to combine grade classification. It must be used separately grade classification)

Characteristic Diagrams

Fig. 1 $I_F - V_F$

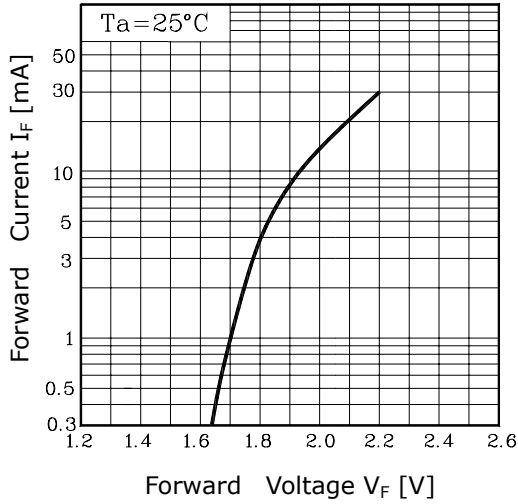

Fig. 2 $I_V - I_F$

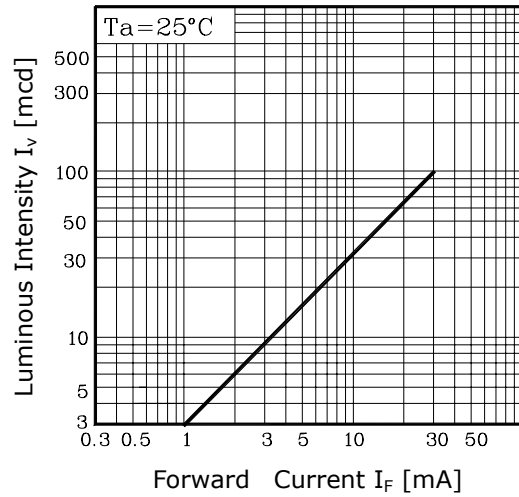

Fig. 3 $I_F - T_a$

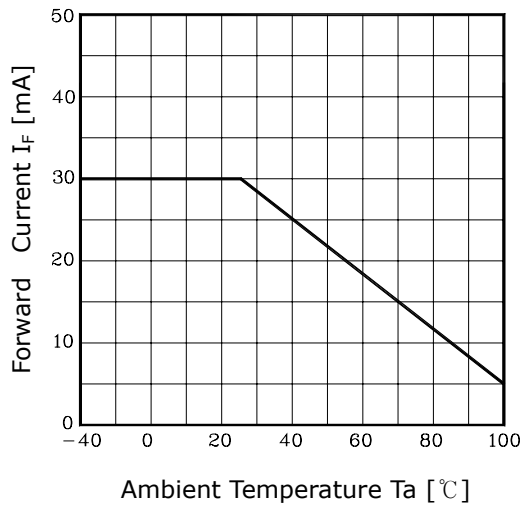

Fig.4 Spectrum Distribution

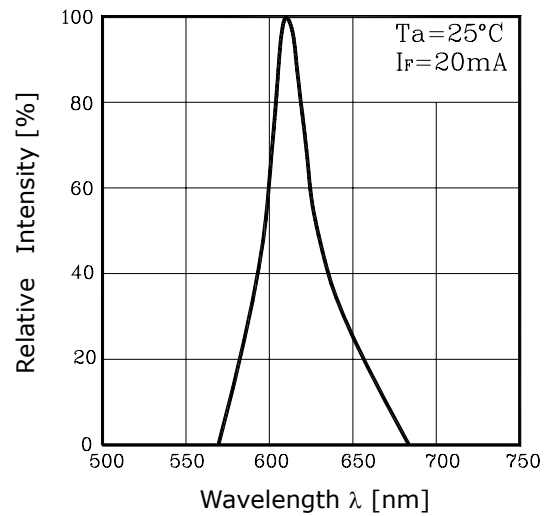
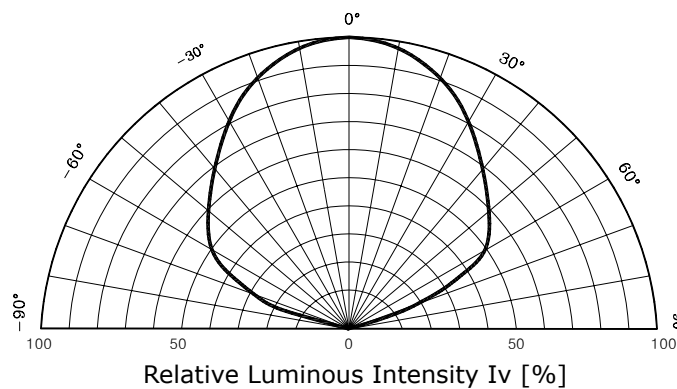

Fig. 5 Radiation Diagram



The AUK Corp. products are intended for the use as components in general electronic equipment (Office and communication equipment, measuring equipment, home appliance, etc.).

Please make sure that you consult with us before you use these AUK Corp. products in equipments which require high quality and / or reliability, and in equipments which could have major impact to the welfare of human life(atomic energy control, airplane, spaceship, transportation, combustion control, all types of safety device, etc.). AUK Corp. cannot accept liability to any damage which may occur in case these AUK Corp. products were used in the mentioned equipments without prior consultation with AUK Corp..

Specifications mentioned in this publication are subject to change without notice.