

# PT481/PT481F/ PT483F1

## ■ Features

1. Epoxy resin package
2. Narrow acceptance ( $\Delta\theta$  : Typ.  $\pm 13^\circ$ )
3. High sensitivity

( $I_c$  : MIN. 1.5mA at  $E_e = 0.1\text{mW/cm}^2$ ) :

**PT481/PT483F1**

( $I_c$  : MIN. 0.9mA at  $E_e = 0.1\text{mW/cm}^2$ ) :

**PT481F**

4. Visible light cut-off type : **PT481F/PT483F1**
5. Long lead pin type : **PT483F1**

www.DataSheet4U.com

## ■ Applications

1. VCRs, cassette tape recorders
2. Floppy disk drives
3. Optoelectronic switches
4. Automatic stroboscopes

## ■ Absolute Maximum Ratings (Ta = 25°C)

Parameter	Symbol	Rating	Unit
Collector-emitter voltage	$V_{CEO}$	35	V
Emitter-collector voltage	$V_{ECO}$	6	V
Collector current	$I_c$	50	mA
Collector power dissipation	$P_c$	75	mW
Operating temperature	$T_{opr}$	-25 to +85	°C
Storage temperature	$T_{stg}$	-40 to +85	°C
*Soldering temperature	$T_{sol}$	260	°C

\*1 For 3 seconds at the position of 1.4mm from the bottom face of resin package

## Narrow Acceptance High Sensitivity Phototransistor

## ■ Outline Dimensions

(Unit : mm)

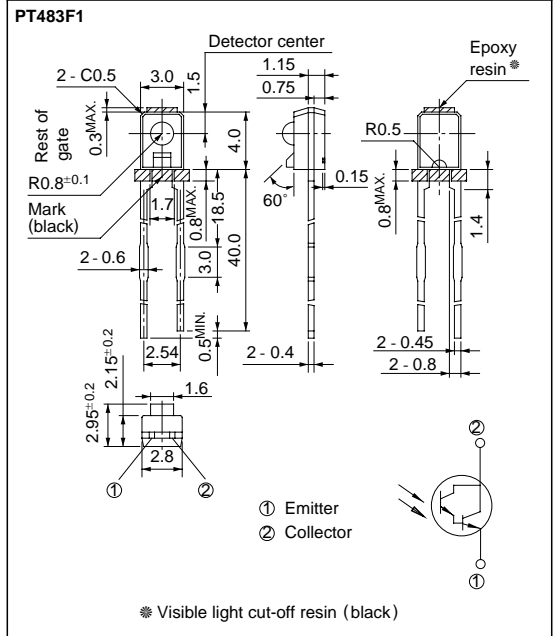
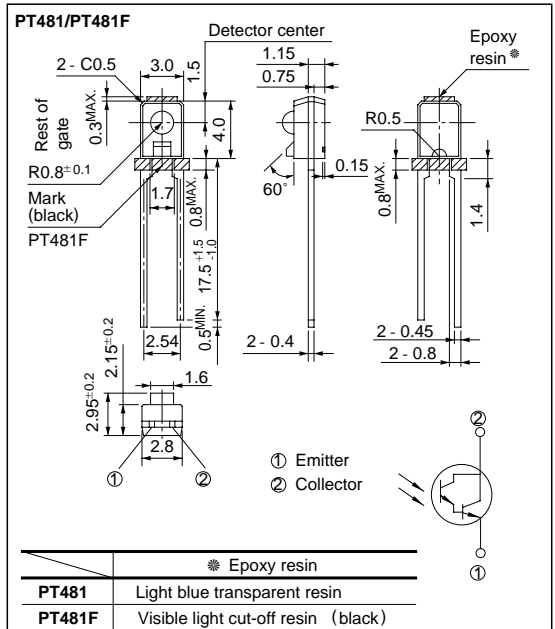

www.DataSheet4U.com

Electro-optical Characteristics

( $T_a = 25^\circ\text{C}$ )

Parameter		Symbol	Conditions	MIN.	TYP.	MAX.	Unit
*2 Collector current	PT481	$I_C$	$V_{CE} = 2\text{V}$ $E_e = 0.1\text{mW/cm}^2$	1.5	10	25	mA
	PT481F			0.9	-	27	mA
	PT483F1			1.5	-	4.0	mA
Collector dark current		$I_{CEO}$	$V_{CE} = 10\text{V}, E_e = 0$	-	-	$10^{-6}$	A
*2 Collector-emitter saturation voltage		$V_{CE(sat)}$	$I_C = 2.5\text{mA}$ $E_e = 1\text{mW/cm}^2$	-	0.7	1.0	V
Peak emission wavelength	PT481	$\lambda_p$	-	-	800	-	nm
	PT481F/PT483F1			-	860	-	nm
Response time	Rise time	$t_r$	$V_{CE} = 2\text{V}, I_C = 10\text{mA}$	-	80	-	$\mu\text{s}$
	Fall time	$t_f$	$R_L = 100\Omega$	-	70	-	$\mu\text{s}$

\*2  $E_e$  : Irradiance by CIE standard light source A (tungsten lamp)

Fig. 1 Collector Power Dissipation vs. Ambient Temperature

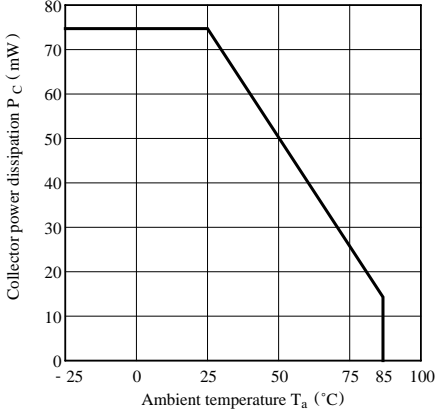

Fig. 2 Collector Dark Current vs. Ambient Temperature

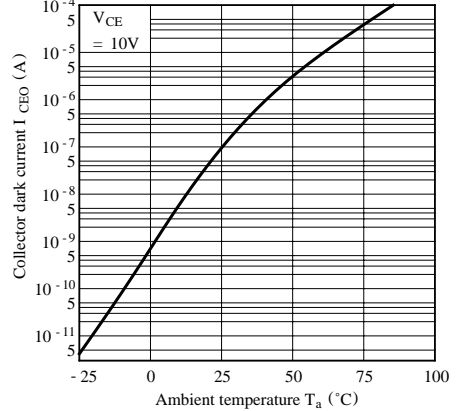

Fig. 3 Relative Collector Current vs. Ambient Temperature

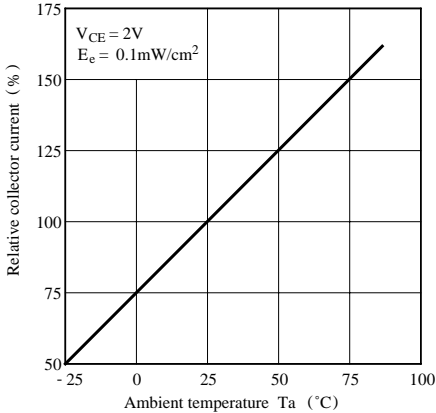
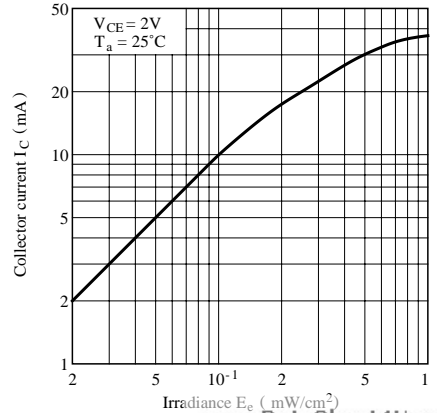
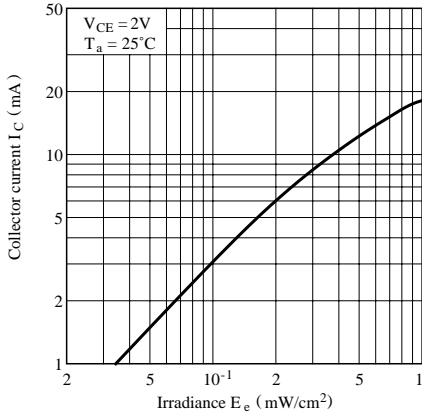

Fig.4-a Collector Current vs. Irradiance (PT481)



**Fig.4-b Collector Current vs. Irradiance**  
(PT481F/PT483F1)



**Fig.5-a Current vs. Collector-emitter Voltage**  
(PT481)

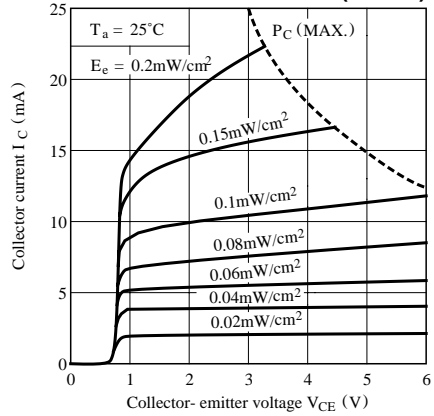

**Fig.5-b Collector Current vs. Collector-emitter Voltage**  
(PT481F/PT483F1)

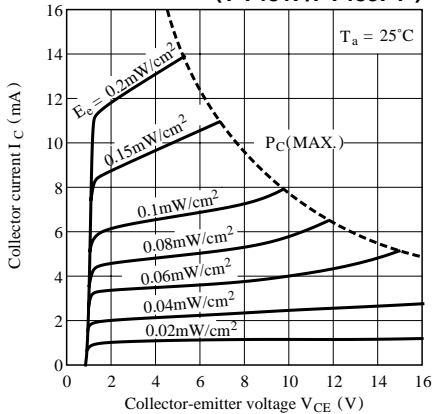

**Fig. 6 Spectral Sensitivity**

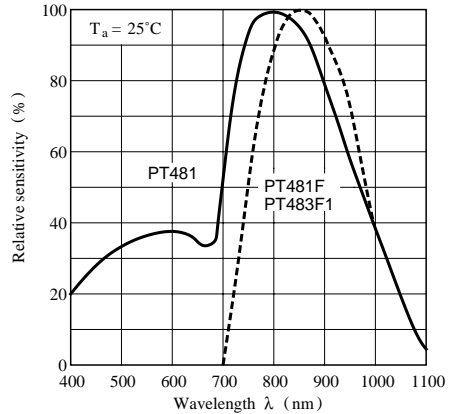

**Fig. 7 Response Time vs. Load Resistance**

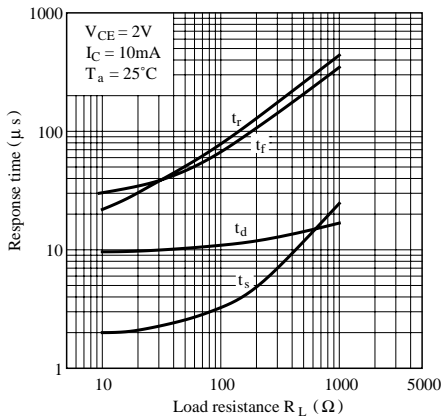

**Test Circuit for Response Time**

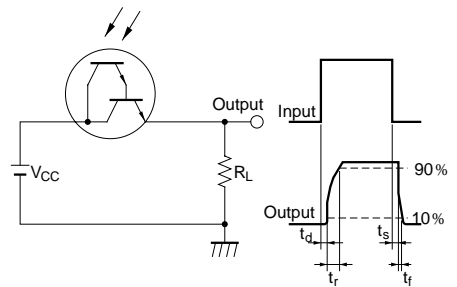

**Fig. 8 Sensitivity Diagram**

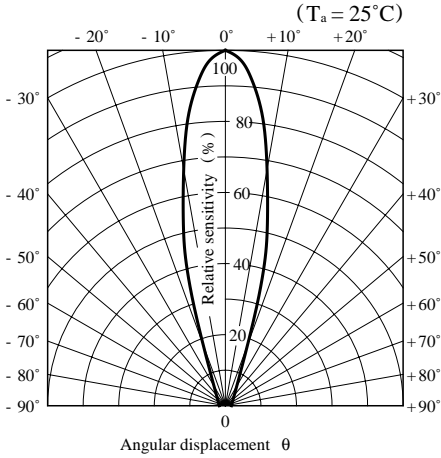

**Fig.9-a Collector-emitter Saturation Voltage vs. Irradiance (PT481)**

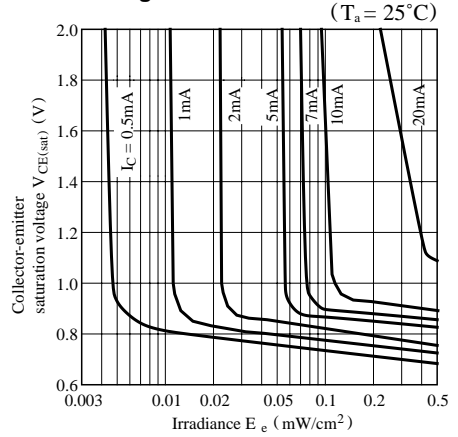

**Fig.9-b Collector-emitter Saturation Voltage vs. Irradiance (PT481F/PT483F1)**

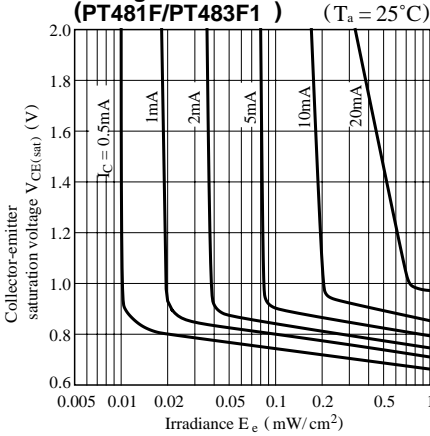

**Fig.10 Relative Output vs. Distance (Emitter : GL480)**

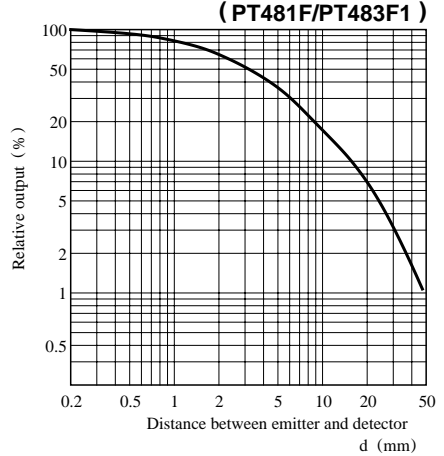

● Please refer to the chapter “Precautions for Use.”