

## CPDT6-5V0U

### RoHS Device

### Features

- IEC61000-4-2 8kV(Contact), 15kV(air).
- Surface mount package.
- High component density.

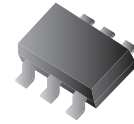

### Mechanical data

- Case: SOT-23-6 Standard package, molded plastic.
- Terminals: Gold plated, solderable per MIL-STD-750D, method 2026.
- Mounting position: Any.
- Weight: 0.015 gram (approx.).

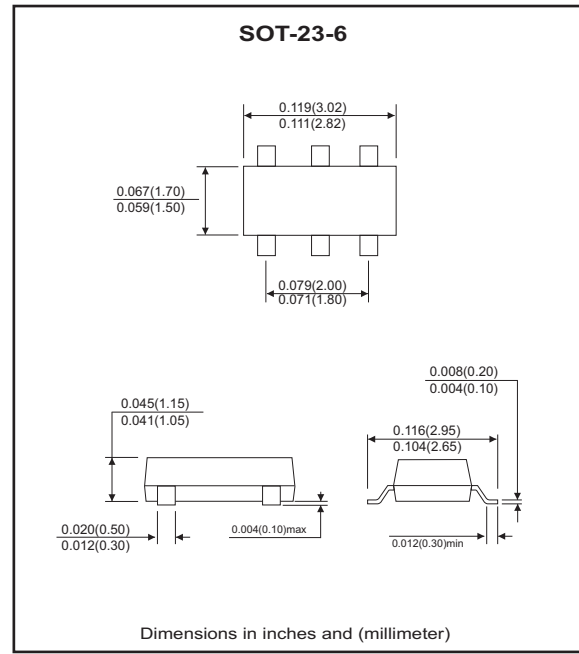

### Marking: E5U

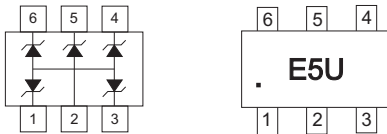

### Maximum Rating and Electrical Characteristics (at TA=25°C unless otherwise noted)

Parameter	Symbol	Conditions	Min	Typ	Max	Unit
Diode breakdown voltage	V <sub>BD</sub>	I <sub>R</sub> = 1mA	6.1		7.1	V
Leakage current	I <sub>L</sub>	V <sub>R</sub> = 3V		0.1	1.0	uA
Forward voltage	V <sub>F</sub>	I <sub>F</sub> = 5uA			1.2	V
Junction capacitance	C <sub>T</sub>	V <sub>R</sub> = 0V, f = 1MHz		60	80	pF
Clamping voltage	V <sub>C</sub>	I <sub>PP</sub> = 1A, T <sub>P</sub> =8/20us I <sub>PP</sub> = 8A, T <sub>P</sub> =8/20us			8 10	V
ESD capability	ESD	C = 150pF, R = 300ohm, forward and reverse 10 pulses	8			kV
Peak pulse power	P <sub>PP</sub>				80	W
Operation temperature	T <sub>J</sub>				125	°C
Storage temperature	T <sub>STG</sub>		-55		150	°C

## RATING AND CHARACTERISTIC CURVES (CPDT6-5V0U)

Fig. 1 - 8/20us Peak pulse current wave form acc. IEC 61000-4-5

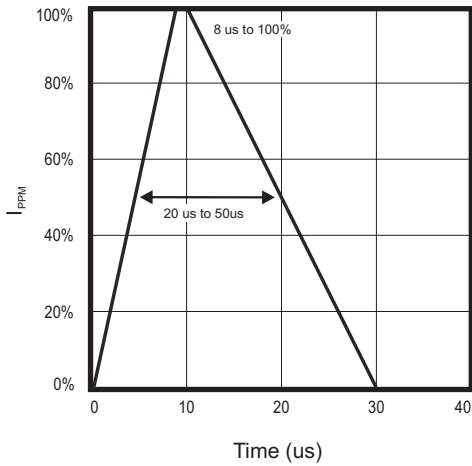

Fig. 2 - Power rating derating curve

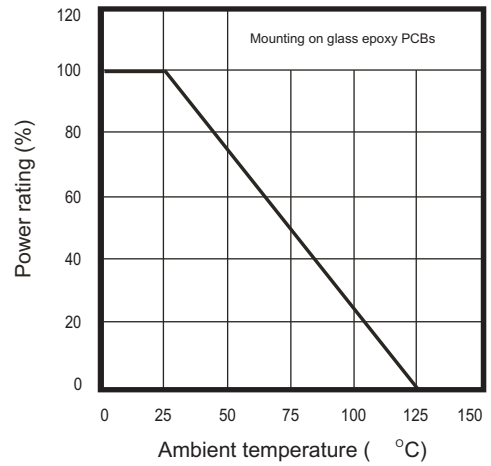

Fig. 3 - Clamping voltage vs. peak pulse current

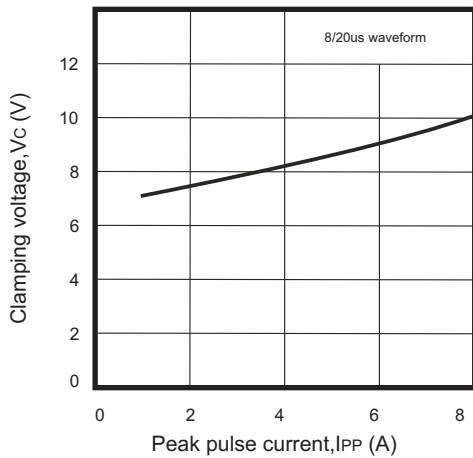
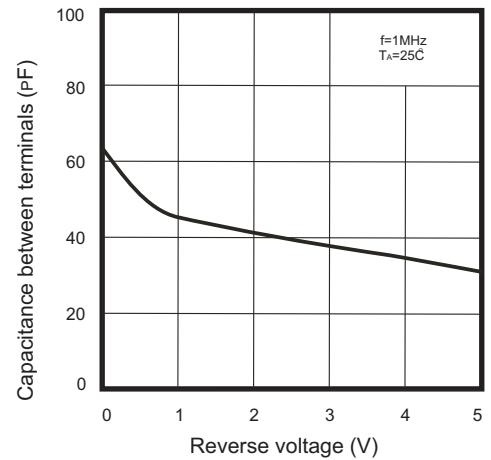
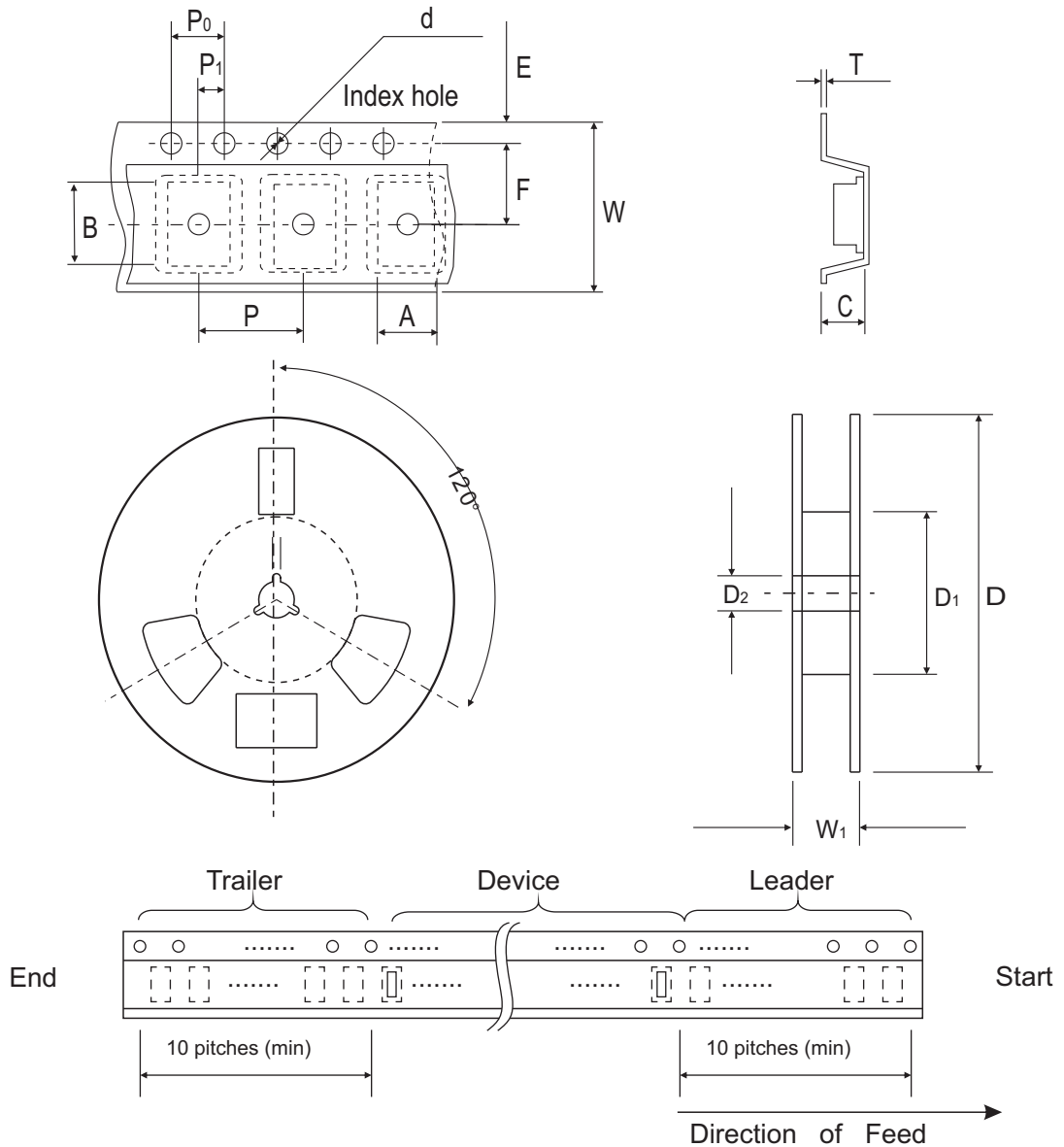

Fig. 4 - Capacitance between terminals characteristics



## Reel Taping Specification



SOT-23-6	SYMBOL	A	B	C	d	D	D <sub>1</sub>	D <sub>2</sub>
	(mm)	3.17 ± 0.10	3.23 ± 0.10	1.37 ± 0.10	1.55 ± 0.10	178 ± 1	50.0 MIN.	13.0 ± 0.20
	(inch)	0.124 ± 0.004	0.127 ± 0.004	0.054 ± 0.004	0.061 ± 0.004	7.008 ± 0.040	1.969 MIN.	0.512 ± 0.008

SOT-23-6	SYMBOL	E	F	P	P <sub>0</sub>	P <sub>1</sub>	W	W <sub>1</sub>
	(mm)	1.75 ± 0.10	3.50 ± 0.05	4.00 ± 0.10	4.00 ± 0.10	2.00 ± 0.05	8.00 ± 0.30	14.4 MAX.
	(inch)	0.069 ± 0.004	0.138 ± 0.002	0.157 ± 0.004	0.157 ± 0.004	0.079 ± 0.002	0.315 ± 0.012	0.567 MAX.

## Marking Code

Part Number	Marking Code
CPDT6-5V0U	E5U

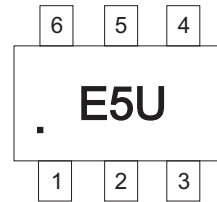

## Suggested PAD Layout

SIZE	SOT-23-6	
	(mm)	(inch)
A	1.10	0.043
B	0.60	0.024
C	0.95	0.037
D	2.50	0.098
E	3.60	0.142

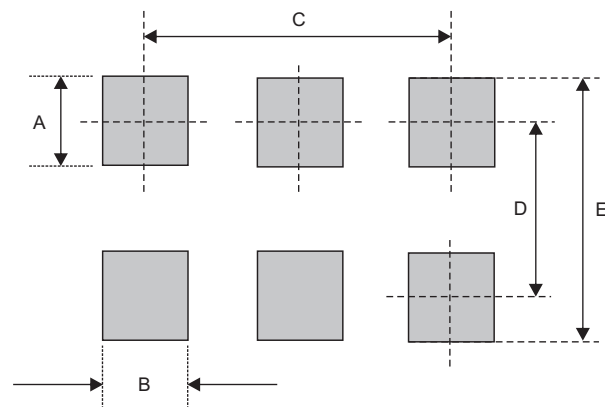

## Standard Package

Case Type	Qty per Reel	Reel Size
	(Pcs)	(inch)
SOT-23-6	3000	7