

# ASSP Image Control

CMOS

# Intelligent On-screen Display Controller (IOSDC)

## MB90091A

### ■ DESCRIPTION

The MB90091A is the multisync, on-screen display controller that supports a variety of TV systems such as NTSC, PAL, double-scan NTSC, double-scan PAL, 1250HDTV, and 1125HDTV as well as personal computer monitor display systems such as VGA and XGA.

The MB90091A contains display memory (VRAM) and character font ROM, allowing characters to be displayed with few external devices. The device also contains command table ROM storing display command data, minimizing the load on the microcomputer.

The on-screen display configuration is up to 24 characters  $\times$  12 lines, with each character consisting of  $24 \times 32$  dots. The font ROM integrates 512 different character patterns.

The character signal output is an RGB1 digital output. The display color of each character can be specified from among 16 colors. A color/monochrome select signal output is also provided for display either in 16 different colors or in 16-level gray scale.

The character display functions include character background display, shaded background display, and sprite character display functions, contributing to providing colorful display screens.

### ■ PACKAGES

64 pin, Plastic SH-DIP

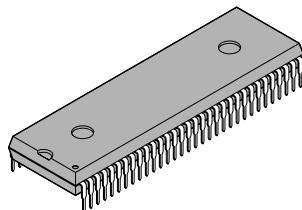

(DIP-64P-M01)

64 pin, Plastic QFP

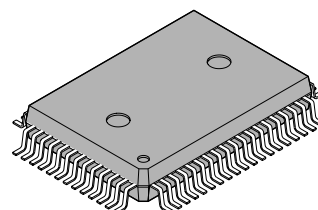

(FPT-64P-M06)

# MB90091A

## ■ FEATURES

- Screen display capacity : Up to 24 characters x 12 lines (288 characters)
- Font size : 24 x 32 dots (horizontal x vertical)
- Font types : 512 different characters (character codes 000H to 1FFH)  
8 different sprite characters (character codes 1F8H to 1FFH)  
(Internal or external ROM selectable)
- Display modes : Trimmed display (pattern background 0, 1, or none)  
Character background (settable for each character)  
Shaded background (settable for each character)
- Sprite character display : Capable of displaying one character (selectable from among 8 types of characters) on the screen  
Sprite character colors : 8 colors  
Sprite trimming colors : 8 colors  
Sprite display position : Settable in 2-dot units on the screen
- Character sizes : Normal, double width, double height, double width x double height, quadruple width, quadruple width x double height  
(Set for each line)
- Display colors : Character color : 16 colors (set for each character)  
Trimmed background color : 16 colors (set for each line)  
Character background color : 16 colors (set for each character)  
Screen background color : 16 colors
- Display position control : Horizontal display start position : Set in 8-dot units  
Vertical display start position : Set in 2-dot units  
Line spacing control : Set in 2-dot units (0 to 30 dots)
- Character/color signal output : ROUT, GOUT, BOUT, IOUT (color signals)  
COLOR (color/monochrome control signal)  
VOB1 (character + pattern background + character background + screen background: all-output signal)  
VOB2 (character + pattern background + character background: specified-character output signal)
- Supported TV systems : NTSC, PAL, double-scan NTSC, double-scan PAL, 1250HDTV, 1125HDTV, etc.  
Personal computer monitor display systems such as VGA
- Intelligent features : Automatic control of operation using on command table ROM  
Command table ROM: Internal 32K bytes + external 32K bytes available
- Microcontroller/microcomputer interface : 8-bit serial input (3 signal input pins)  
Chip select:  $\overline{SCS}$   
Serial clock: SCLK  
Serial data: SIN
- Package : SH-DIP-64, QFP-64
- Miscellaneous : Power-on reset circuit integrated

## ■ PIN ASSIGNMENTS

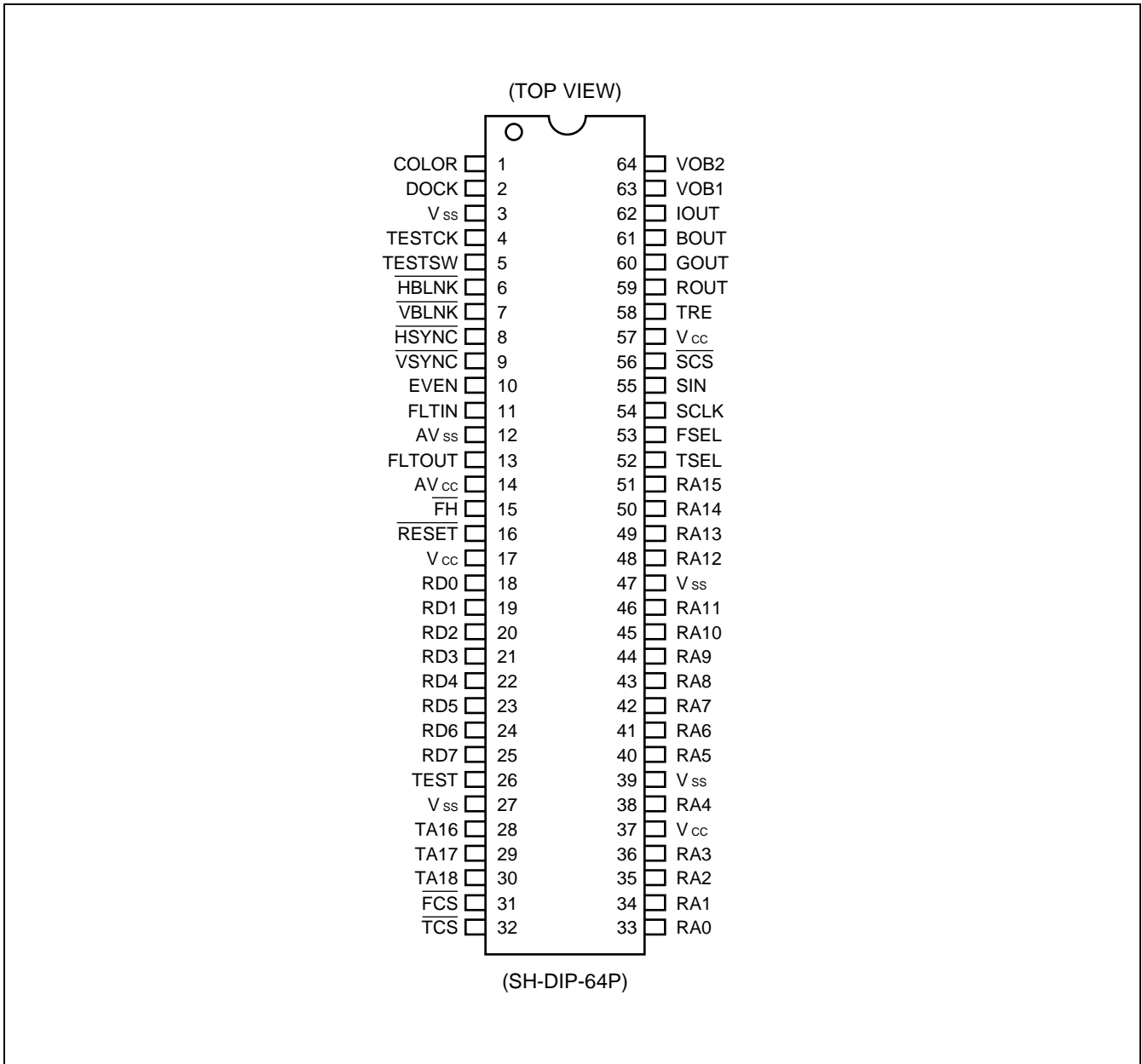

(Continued)

# MB90091A

(Continued)

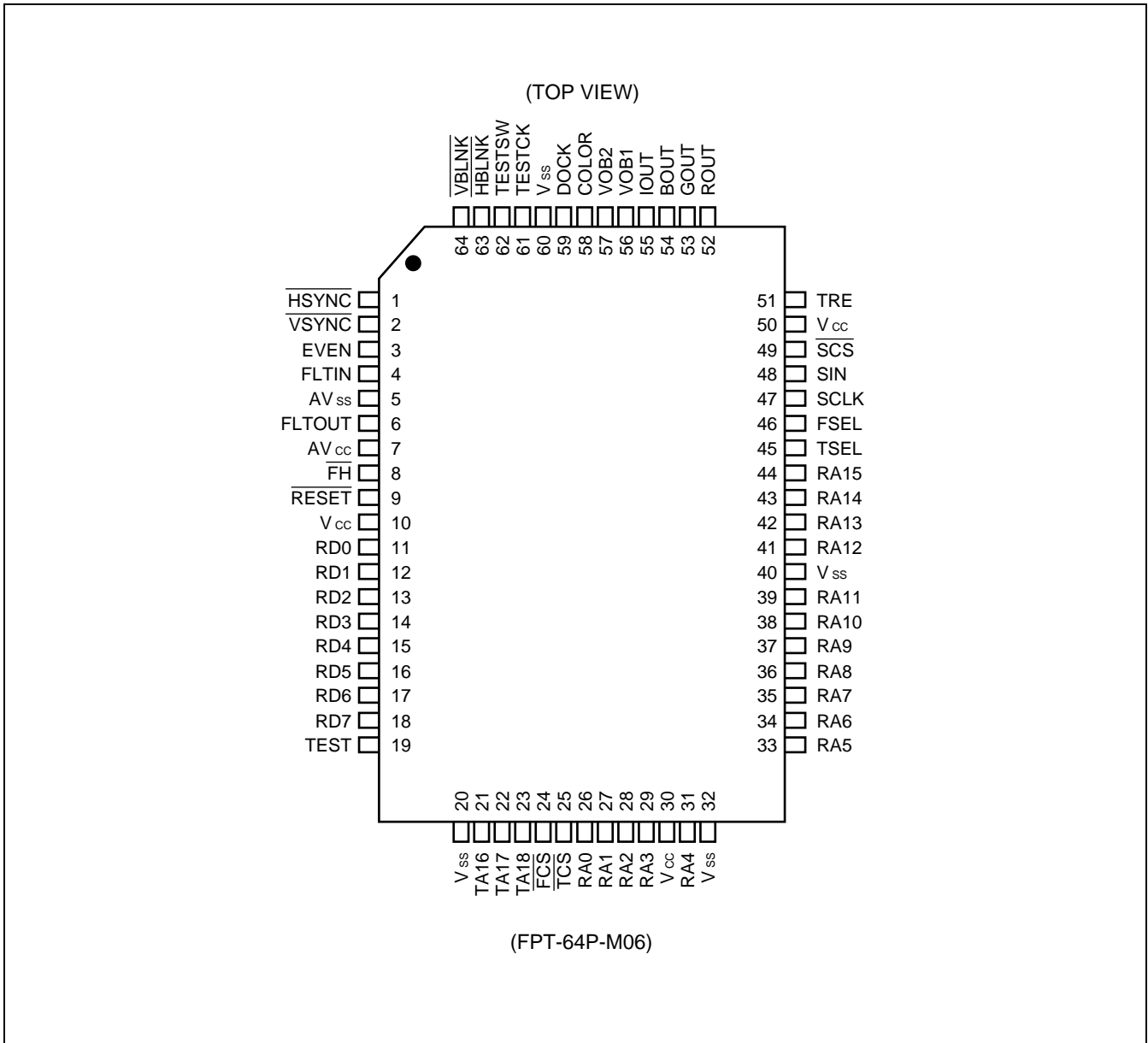

## ■ PIN DESCRIPTION

Pin No.		Pin name	I/O	Function
DIP	QFP			
8	1	$\overline{\text{HSYNC}}$	I	Horizontal sync signal input pin Dot clock generation is based on the cycle of the signal.
9	2	$\overline{\text{VSYNC}}$	I	Vertical sync signal input pin
10	3	EVEN	I	Field control signal input pin Input of an "L" level signal to this pin causes the font ROM address LSB pin (RA0) to output an "L" level signal. Input of an "H" level signal to this pin causes the font ROM address LSB pin (RA0) to output an "H" level signal (when normal-size characters are displayed). This pin is disabled in noninterlaced mode.
11	4	FLTIN	O	Output pin for horizontal-sync phase comparison result signal This pin is connected to an external lowpass filter.
13	6	FLTOUT	I	Internal VCO voltage input pin This pin inputs the voltage signal from the external lowpass filter.
15	8	$\overline{\text{FH}}$	O	Output pin for AFC-generated horizontal sync signal
16	9	$\overline{\text{RESET}}$	I	Reset pin This pin is enabled after release from a power-on reset.
18 19 20 21 22 23 24 25	11 12 13 14 15 16 17 18	RD0 RD1 RD2 RD3 RD4 RD5 RD6 RD7	I	External ROM data input pin This pin inputs data from external font ROM or external command data ROM.
26	19	TEST	I	Test signal input pin This pin inputs an "L" level (fixed) signal during normal operation.
28 29 30	21 22 23	TA16 TA17 TA18	O	Test signal output pin
31	24	$\overline{\text{FCS}}$	O	External font ROM chip select pin
32	25	$\overline{\text{TCS}}$	O	Chip select pin for external command table ROM

(Continued)

# MB90091A

(Continued)

Pin No.		Pin name	I/O	Function
DIP	QFP			
33	26	RA0	O	<p>External ROM address signal output pin This pin outputs the signal specifying the external font ROM or external command table ROM address.</p> <p>External font ROM addresses  RA0 to RA4 : Raster addresses  RA5 to RA11 : Character codes (M0 to M6)  RA12, RA13 : Character horizontal address  = (0, 0): Left byte  = (1, 0): Center byte  = (0, 1): Right byte  RA14, RA15 : Character codes (M7, M8)</p>
34	27	RA1		
35	28	RA2		
36	29	RA3		
38	31	RA4		
40	33	RA5		
41	34	RA6		
42	35	RA7		
43	36	RA8		
44	37	RA9		
45	38	RA10		
46	39	RA11		
48	41	RA12		
49	42	RA13		
50	43	RA14		
51	44	RA15		
52	45	TSEL	I	<p>Address control input pin for command table ROM  “L” level input : 0000H to 7FFFH Internal ROM  8000H to FFFFH External ROM  “H” level input : 0000H to 7FFFH External ROM  8000H to FFFFH Internal ROM</p>
53	46	FSEL	I	<p>Internal/external font ROM select pin  “L” level input : Select internal ROM.  “H” level input : Select external ROM.</p>
54	47	SCLK	I	Shift clock input pin for serial transfer
55	48	SIN	I	Serial data input pin
56	49	$\overline{\text{SCS}}$	I	<p>Chip select pin  For serial transfer, set this pin to the “L” level.  This pin is also used to cancel a power-on reset.</p>
58	51	TRE	O	<p>Output pin for the signal indicating internal operation  This pin outputs an “H” level signal during data transfer from command table ROM.</p>
59	52	ROUT	O	<p>Chrominance signal output pin  For output of a character, character background, pattern background, shaded background, screen background, or sprite character (including a pattern background), this pin outputs the chrominance signal.</p>
60	53	GOUT		
61	54	BOUT		
62	55	IOUT		
63	56	VOB1	O	<p>Pin for specifying the chrominance signal output period  This pin outputs an “H” level signal for output of a character, character background, pattern background, shaded background, screen background, or sprite character (including a pattern background).</p>
64	57	VOB2	O	<p>Pin for specifying the specified character output period  When the command 6: ATH bit = “1”, this pin outputs an “H” level signal in the character output period (24 x 32 dot period) when the command 1: AT bit = “1”.  The pin can be used for display control by an external circuit, for example, for halftone display control.</p>

(Continued)

(Continued)

Pin No.		Pin name	I/O	Function
DIP	QFP			
1	58	COLOR	O	Color/monochrome select signal output pin This pin allows "H" or "L" level output in each of the character, character background, line background, screen background, and sprite output periods to be specified depending on the internal register setting. Color/monochrome display is controlled by an external circuit. (The following correspondence is used for convenience: "L" level: Monochrome display "H" level: Color display)
2	59	DOCK	O	Dot clock output pin This pin outputs a dot clock signal when the command 11:DOT = "1".
4	61	TESTCK	I	Test signal input pin This pin inputs an "H" level (fixed) signal during normal operation.
5	62	TESTSW	I	Test signal input pin This pin inputs an "H" level (fixed) signal during normal operation.
6	63	$\overline{\text{HBLNK}}$	I	Horizontal blanking signal input pin This pin stops display signal output ("L" level output) when it inputs an "L" level signal.
7	64	$\overline{\text{VBLNK}}$	I	Vertical blanking signal input pin This pin stops display signal output ("L" level output) when it inputs an "L" level signal.
17 37 57	10 30 50	Vcc	—	+5 V power supply pin
27 39 47 3	20 32 40 60	Vss	—	Ground pin
14	7	AVcc	—	+5V power supply pin for VCO
12	5	AVss	—	Ground pin for VCO

# MB90091A

## ■ BLOCK DIAGRAM

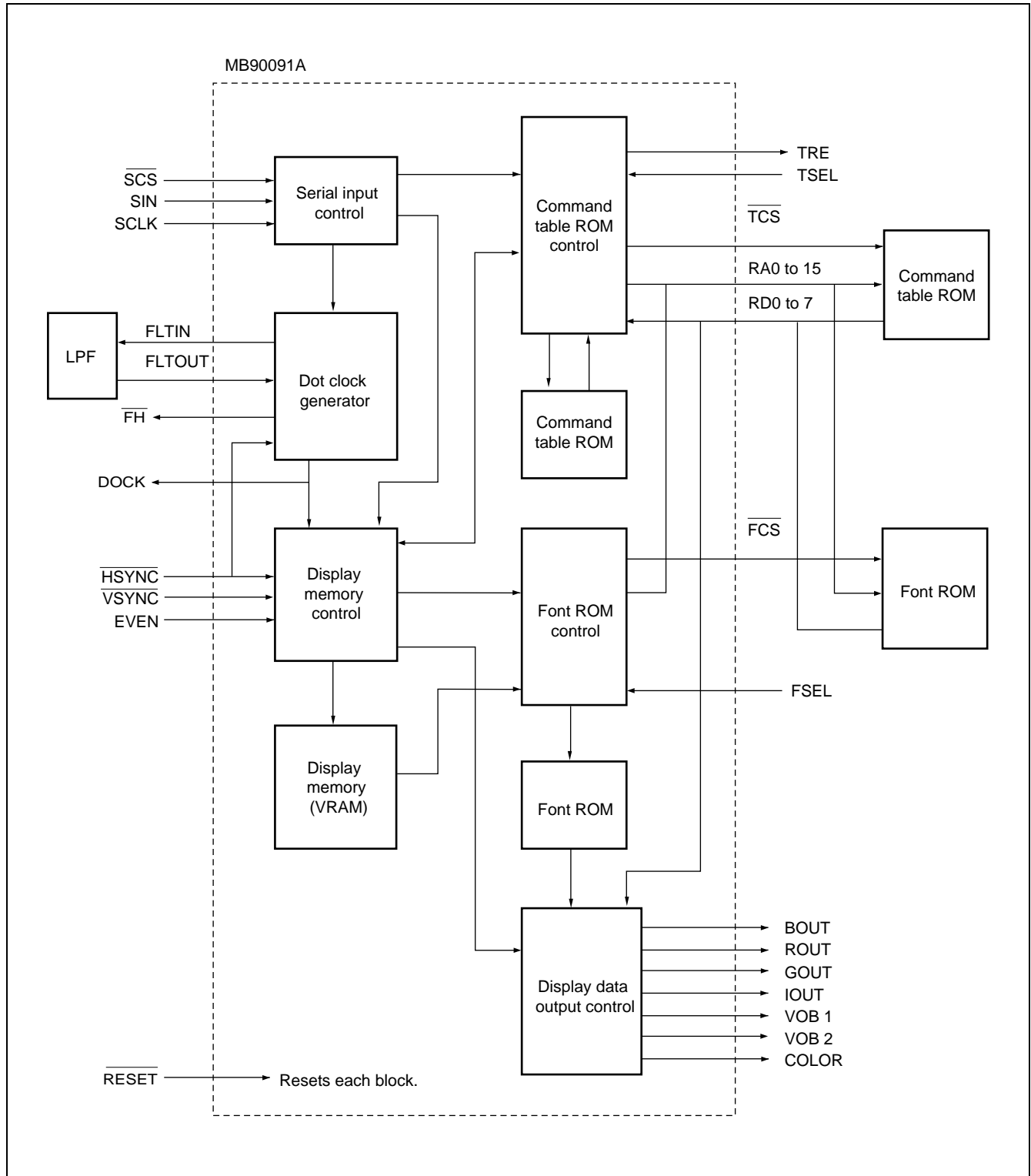



## ■ ABSOLUTE MAXIMUM RATINGS

(V<sub>SS</sub> = AV<sub>SS</sub> = 0 V)

Parameter	Symbol	Ratings		Unit
		Min.	Max.	
Power supply voltage *1	V <sub>CC</sub>	V <sub>SS</sub> - 0.3	V <sub>SS</sub> + 7.0	V
	AV <sub>CC</sub>	V <sub>SS</sub> - 0.3	V <sub>SS</sub> + 7.0	V
Input voltage *2	V <sub>IN</sub>	V <sub>SS</sub> - 0.3	V <sub>SS</sub> + 7.0	V
Output voltage *3	V <sub>OUT</sub>	V <sub>SS</sub> - 0.3	V <sub>SS</sub> + 7.0	V
Power consumption	P <sub>d</sub>	—	500	mW
Operating temperature	T <sub>a</sub>	0	+70	°C
Storage temperature	T <sub>stg</sub>	-55	+150	°C

\*1: AV<sub>CC</sub> and V<sub>CC</sub> must have equal potential.

\*2: Neither V<sub>IN</sub> nor V<sub>OUT</sub> must exceed "V<sub>CC</sub> + 0.3 V".

WARNING: Semiconductor devices can be permanently damaged by application of stress (voltage, current, temperature, etc.) in excess of absolute maximum ratings. Do not exceed these ratings.

## ■ RECOMMENDED OPERATING CONDITIONS

(V<sub>SS</sub> = AV<sub>SS</sub> = 0 V)

Parameter	Symbol	Values		Unit	Remarks
		Min.	Max.		
Power supply voltage *	V <sub>CC</sub>	4.75	5.25	V	Specification guarantee range
	AV <sub>CC</sub>	4.75	5.25	V	
"H" level input voltage	V <sub>IHS1</sub>	2.4	V <sub>CC</sub> + 0.3	V	RD0 to RD7 inputs
	V <sub>IHS2</sub>	0.8 × V <sub>CC</sub>	V <sub>CC</sub> + 0.3	V	Other inputs
"L" level input voltage	V <sub>ILS1</sub>	-0.3	0.45	V	RD0 to RD7 inputs
	V <sub>ILS2</sub>	V <sub>SS</sub> - 0.3	0.2 × V <sub>CC</sub>	V	Other inputs
Operating temperature	T <sub>a</sub>	0	+70	°C	
Analog input voltage	V <sub>IN</sub>	0	V <sub>CC</sub>	V	FLTOUT input

\* : AV<sub>CC</sub> and V<sub>CC</sub> must have equal potential.

WARNING: Recommended operating conditions are normal operating ranges for the semiconductor device. All the device's electrical characteristics are warranted when operated within these ranges.

Always use semiconductor devices within the recommended operating conditions. Operation outside these ranges may adversely affect reliability and could result in device failure.

No warranty is made with respect to uses, operating conditions, or combinations not represented on the data sheet. Users considering application outside the listed conditions are advised to contact their FUJITSU representative beforehand.

# MB90091A

## ■ ELECTRICAL CHARACTERISTICS

### 1. DC Characteristics

Parameter	Symbol	Pin	Conditions	Values			Unit
				Min.	Typ.	Max.	
"H" level output voltage	V <sub>OH</sub>	All out-put pins	V <sub>CC</sub> = 4.75 V I <sub>OH</sub> = - 2.0 mA	4.0	—	—	V
"L" level output voltage	V <sub>OL</sub>		V <sub>CC</sub> = 4.75 V I <sub>OL</sub> = 4.0 mA	—	—	0.4	V
Input current	I <sub>IL</sub>	$\overline{\text{HSYNC}}$ $\overline{\text{VSYNC}}$ $\overline{\text{EVEN}}$ $\overline{\text{RESET}}$ RD0 to RD7 TSEL FSEL SCLK SIN SCS $\overline{\text{HBLNK}}$ $\overline{\text{VBLNK}}$	V <sub>CC</sub> = 5.25 V I <sub>IL</sub> = 4.0 mA	—	—	- 50	mA
Supply current	I <sub>CC</sub>	V <sub>CC</sub> AV <sub>CC</sub>	V <sub>CC</sub> = AV <sub>CC</sub> = 5.25 V DOCK = 42 MHz No load	—	—	40	mA

## 2. AC Characteristics

### (1) Serial input timing

( $V_{CC} = AV_{CC} = 5.0\text{ V} \pm 5\%$ ,  $V_{SS} = AV_{SS} = 0\text{ V}$ ,  $T_a = 0^\circ\text{C}$  to  $+70^\circ\text{C}$ )

Parameter	Symbol	Pin	Values		Unit
			Min.	Max.	
Shift clock cycle time	$t_{CVC}$	SCLK	1000	—	ns
Shift clock pulse width	$t_{WCH}$	SCLK	450	—	ns
	$t_{WCL}$		450	—	ns
Shift clock signal rise/fall time	$t_{CR}$	SCLK	—	200	ns
	$t_{CF}$		—	200	ns
Shift clock start time	$t_{SS}$	SCLK	200	—	ns
Data setup time	$t_{SU}$	SIN	200	—	ns
Data hold time	$t_H$	SIN	100	—	ns
Chip select end time	$t_{EC}$	$\overline{\text{SCS}}$	500	—	ns
Chip select signal rise/fall time	$t_{CRC}$	$\overline{\text{SCS}}$	—	200	ns
	$t_{CFC}$		—	200	ns

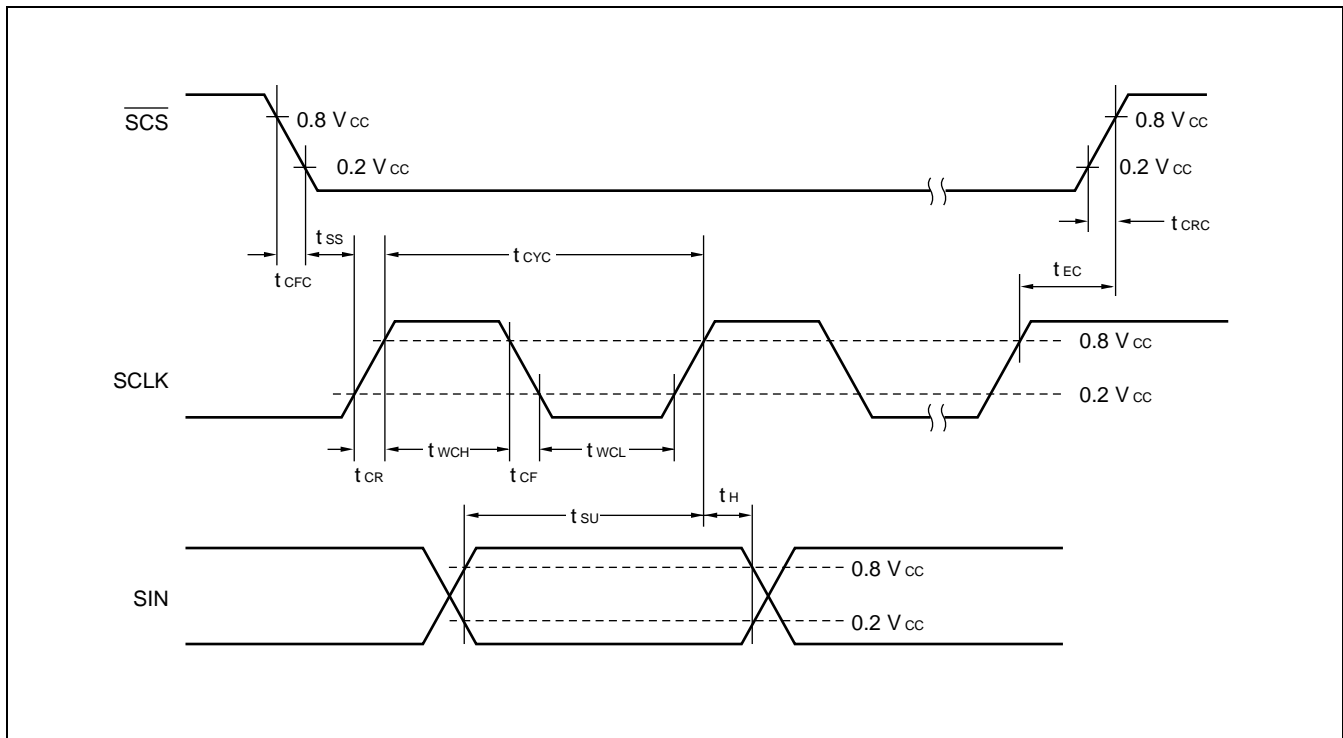

# MB90091A

## (2) Vertical and horizontal sync signal input timings

( $V_{CC} = AV_{CC} = 5.0 \text{ V} \pm 5\%$ ,  $V_{SS} = AV_{SS} = 0 \text{ V}$ ,  $T_a = 0^\circ\text{C to } +70^\circ\text{C}$ )

Parameter	Symbol	Pin	Values		Unit
			Min.	Max.	
Horizontal sync signal rise time	$t_{HR}$	$\overline{\text{HSYNC}}$	—	200	ns
Horizontal sync signal fall time	$t_{HF}$	$\overline{\text{HSYNC}}$	—	200	ns
Vertical sync signal rise time	$t_{VR}$	$\overline{\text{VSYNC}}$	—	200	ns
Vertical sync signal fall time	$t_{VF}$	$\overline{\text{VSYNC}}$	—	200	ns
Horizontal sync signal pulse width	$t_{WH}$	$\overline{\text{HSYNC}}$	1	—	$\mu\text{s}$
Vertical sync signal pulse width	$t_{WV}$	$\overline{\text{VSYNC}}$	2	—	H
Horizontal sync signal setup time	$t_{HVST}$	$\overline{\text{VSYNC}}$	5	—	$\mu\text{s}$
Vertical sync signal setup time	$t_{HVHD}$	$\overline{\text{VSYNC}}$	5	—	$\mu\text{s}$

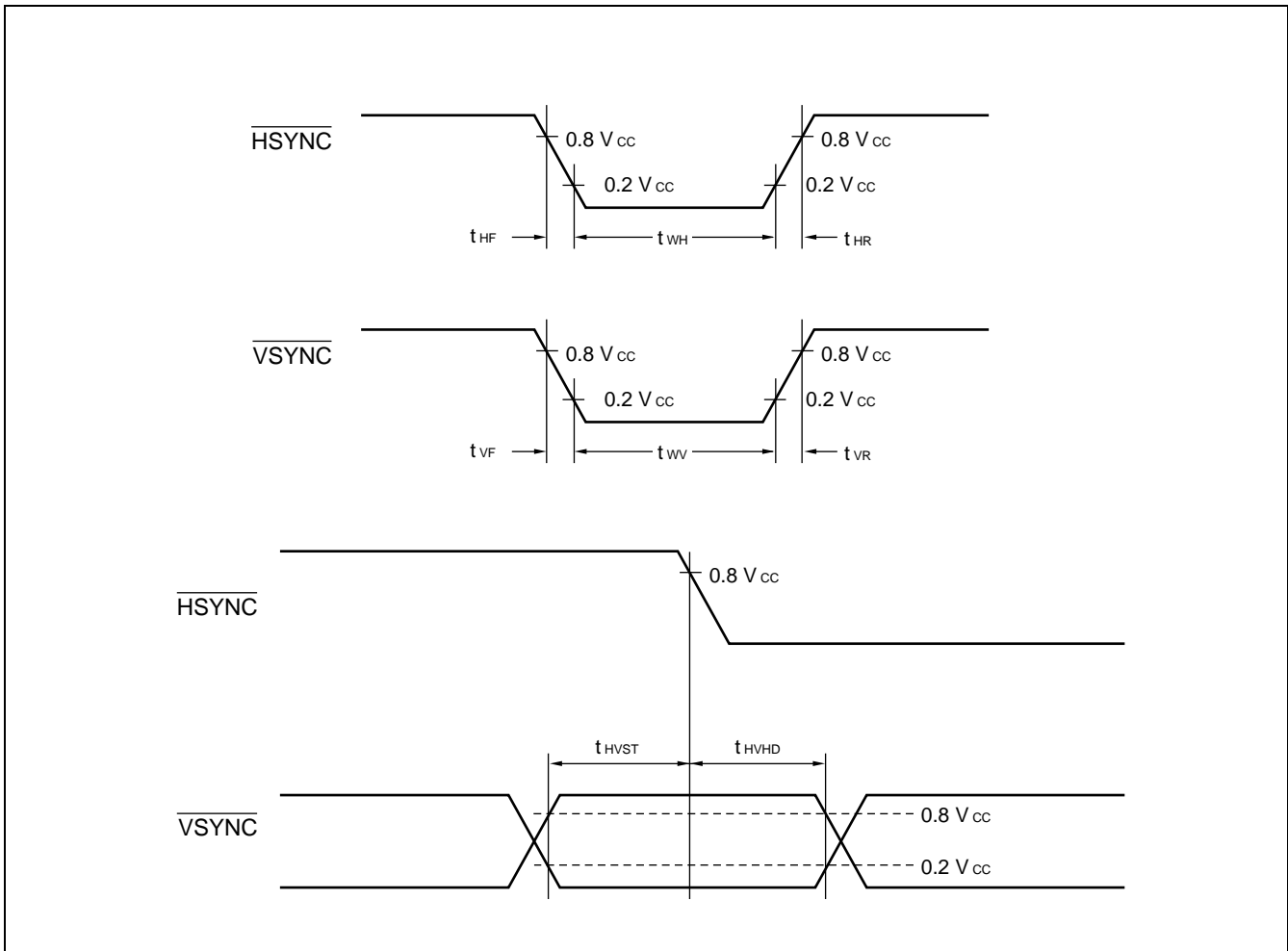

The MB90091A outputs display signals in synchronization with sync signals input from external circuits. The signals required for controlling synchronization are the horizontal sync signal (input via the  $\overline{\text{HSYNC}}$  pin), vertical sync signal (input via the  $\overline{\text{VSYNC}}$  pin), and field control signal (input via the EVEN pin).

The following examples illustrate external sync signal input timings applicable to general interlaced display. Noninterlaced display does not require the EVEN pin signal.

• External sync signal input timing examples

(1) Field A

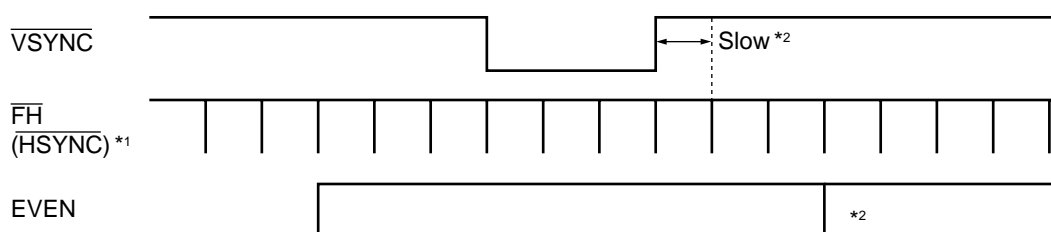

(2) Field B

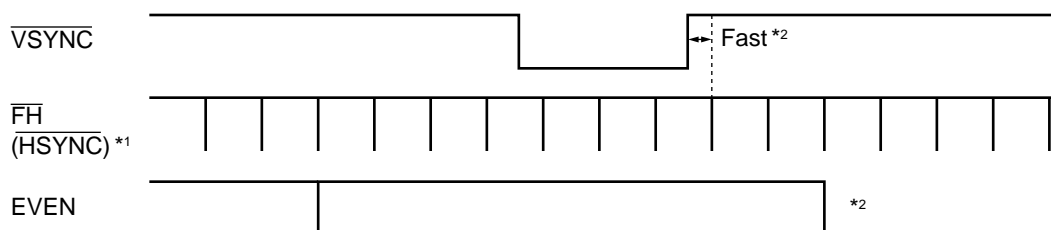

\*1: Input the horizontal sync signal to the  $\overline{\text{HSYNC}}$  pin.

Input of a composite sync signal may change the  $\overline{\text{FH}}$  signal cycle due to the PLL lock disturbed around the  $\overline{\text{VSYNC}}$  pulse, requiring a caution to be used for the timing of input to the EVEN pin. (See \*2 below.)

\*2: The input levels of the EVEN pin input signal in fields A and B are determined depending on the relationship between the  $\overline{\text{VSYNC}}$  and  $\overline{\text{FH}}$  pulse positions. To the EVEN pin, input the "L" level signal in the field in which the  $\overline{\text{FH}}$  pulse after the rise of the  $\overline{\text{VSYNC}}$  pulse appears fast. Pin the "H" level signal in the field in which it appears slow.

The EVEN pin input signal should vary in the undisplay period such as around the  $\overline{\text{VSYNC}}$  pulse.

# MB90091A

(3)  $\overline{\text{RESET}}$  signal input timing

( $V_{CC} = AV_{CC} = 5.0 \text{ V} \pm 5\%$ ,  $V_{SS} = AV_{SS} = 0 \text{ V}$ ,  $T_a = 0^\circ\text{C}$  to  $+70^\circ\text{C}$ )

Parameter	Symbol	Pin	Values		Unit
			Min.	Max.	
Reset input pulse width	$t_{WR}$	$\overline{\text{RESET}}$	10	—	$\mu\text{s}$

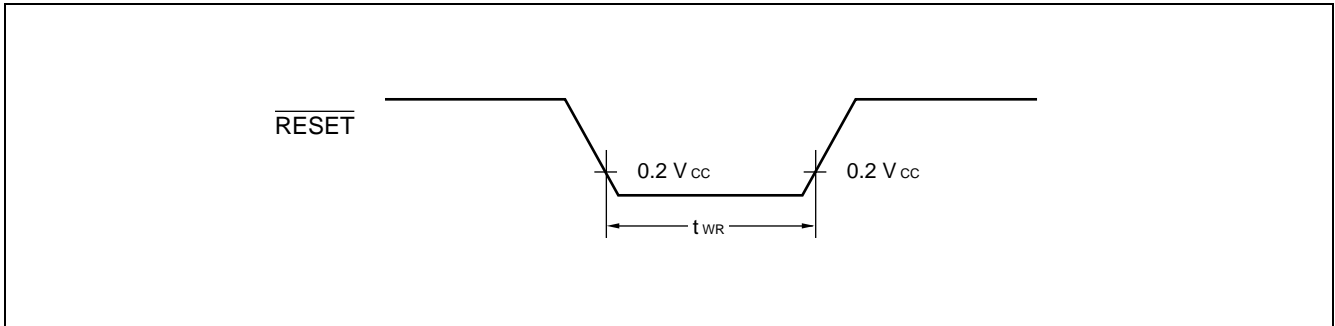

(4) Address data hold timing

(V<sub>CC</sub> = AV<sub>CC</sub> = 5.0 V ± 5%, V<sub>SS</sub> = AV<sub>SS</sub> = 0 V, T<sub>a</sub> = 0°C to +70°C)

Parameter	Symbol	Pin	Values		Unit
			Min.	Max.	
ROM read cycle	t <sub>royc</sub>	—	Dot clock* x 8		—
Address valid delay	t <sub>av</sub>	RA0 to RA15	—	30	ns
Address invalid delay	t <sub>ai</sub>		0	—	ns
Read data setup	t <sub>ds</sub>	RD0 to RD7	30	—	ns
Read data hold	t <sub>dh</sub>		0	—	ns
$\overline{\text{TCS}}$ , $\overline{\text{FCS}}$ active delay	t <sub>ca</sub>	$\overline{\text{TCS}}$ , $\overline{\text{FCS}}$	—	22	ns
$\overline{\text{TCS}}$ , $\overline{\text{FCS}}$ inactive delay	t <sub>ci</sub>		0	—	ns

\* : Dot clock = 84 to 42 MHz

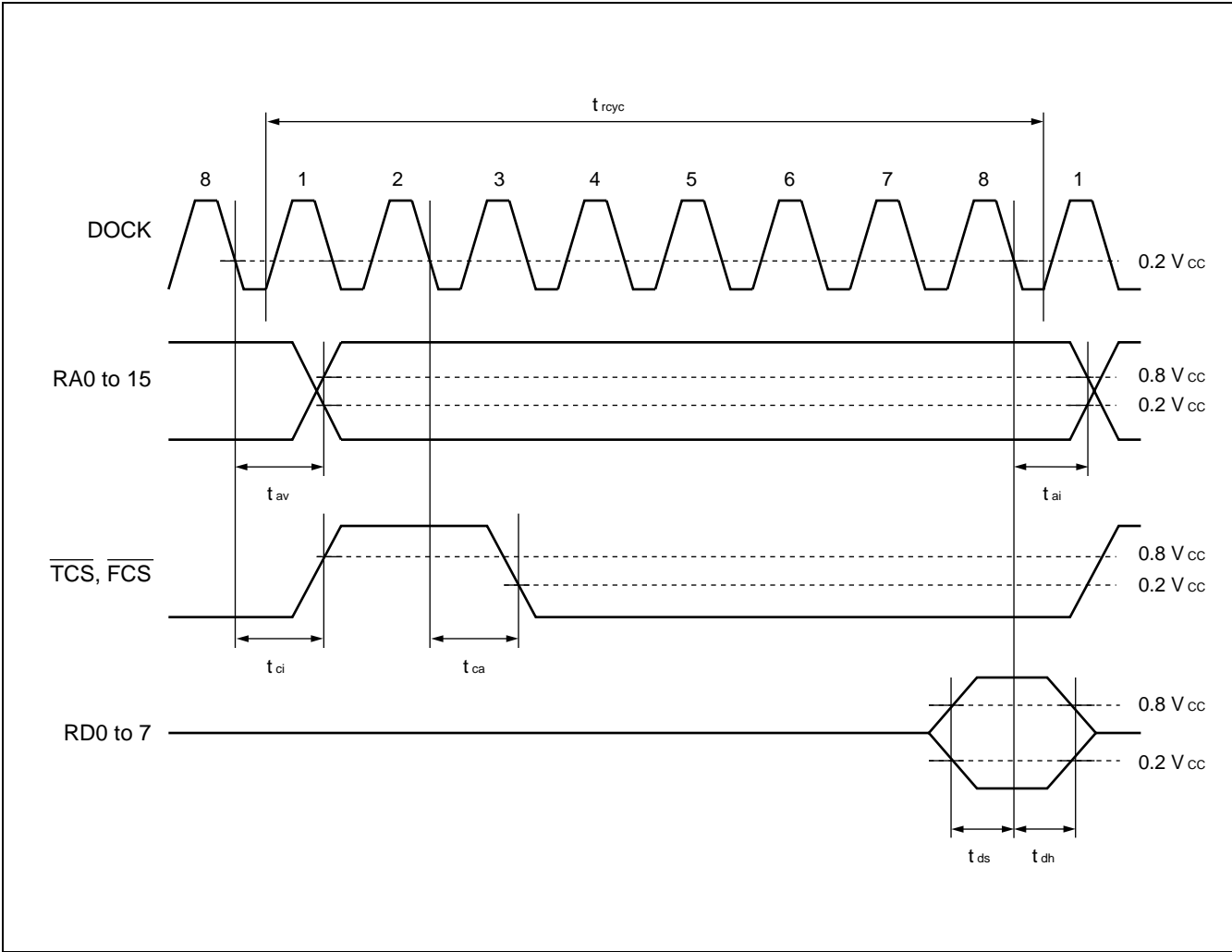

# MB90091A

## (5) Display data output timing

( $V_{cc} = AV_{cc} = 5.0 \text{ V} \pm 5\%$ ,  $V_{ss} = AV_{ss} = 0 \text{ V}$ ,  $T_a = 0^\circ\text{C}$  to  $+70^\circ\text{C}$ )

Parameter	Symbol	Pin	Values		Unit
			Min.	Max.	
Display data output delay	$t_{d1}$	ROUT, GOUT, BOUT IOUT, VOB1, VOB2 COLOR	0	22	ns

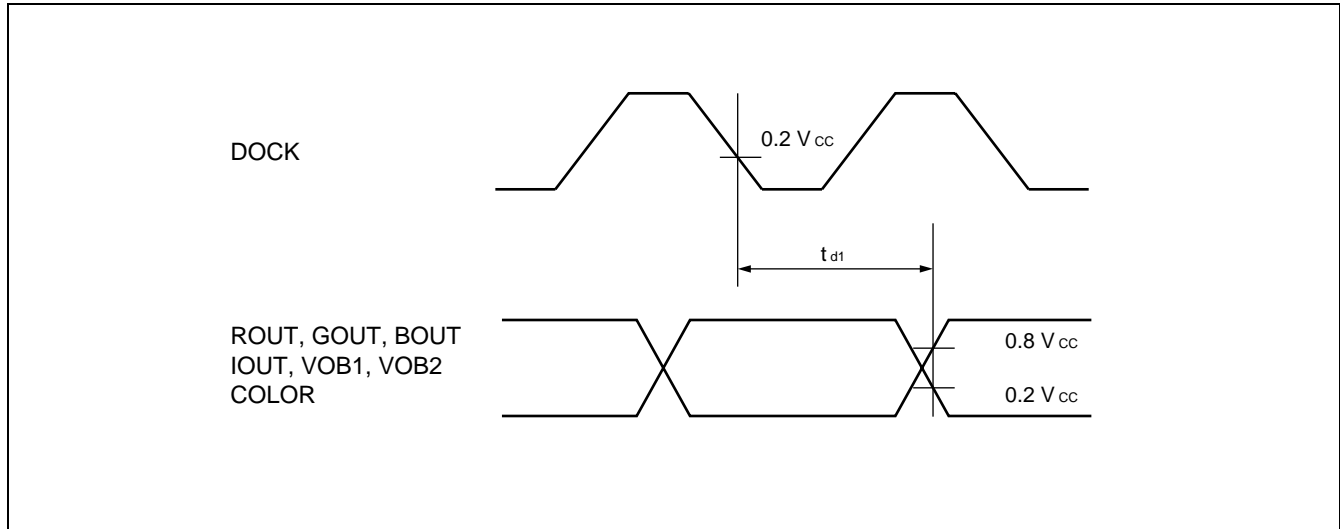



## 3. Power-on Reset Specifications

(1) Power ON-OFF timing

(Ta = 0°C to +70°C)

Parameter	Symbol	Pin	Values		Unit	Remarks
			Min.	Max.		
Power-supply rise time	$t_r$	Vcc, AVcc	0.05	50	ms	Power-on reset circuit activating conditions
Power-supply shut-off time	$t_{off}$		1	—	ms	Conditions in which the circuit repeatedly operate normally

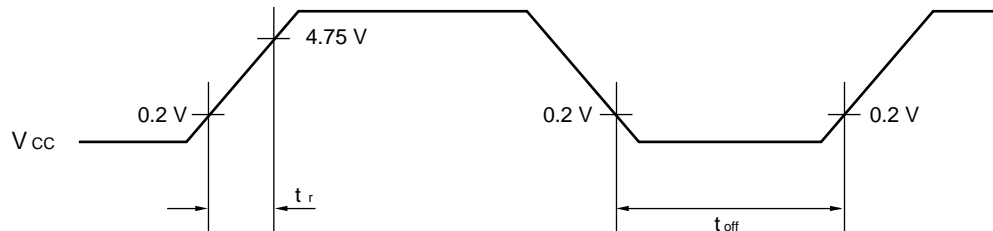

Note: The power supply must be activated smoothly

# MB90091A

## (2) Power-on reset cancel timing

(Ta = 0°C to +70°C)

Parameter	Symbol	Pin	Values		Unit	Remarks
			Min.	Max.		
Time after rise	t <sub>WIT</sub>	$\overline{\text{SCS}}$	450	—	ns	Power-on reset cancel timing
Reset cancel pulse width	t <sub>WRH</sub>		450	—	ns	
	t <sub>WRL</sub>		450	—	ns	

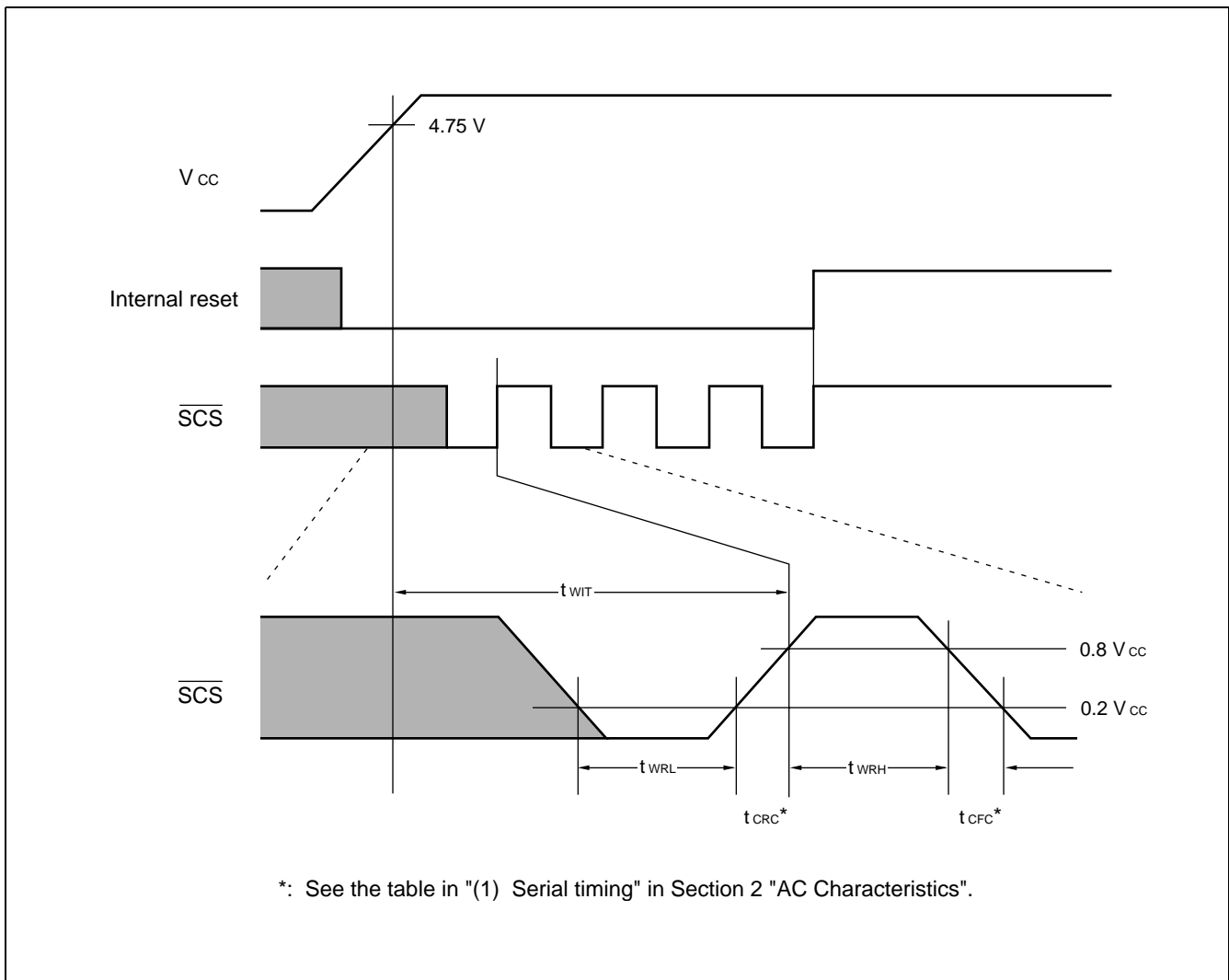

## ■ Command List

### • List of display control commands

Command No.	First byte				Second byte								Function
	Command code/data				Data								
	76543	2	1	0	7	6	5	4	3	2	1	0	
0	10000	0	A8	A7	0	A6	A5	A4	A3	A2	A1	A0	Set write address
1	10001	AT	BS	B1	0	BG	BR	BB	CI	CG	CR	CB	Set character color
2	10010	0	M8	M7	0	M6	M5	M4	M3	M2	M1	M0	Set character code
3	10011	X9	X8	X7	0	0	G2	G1	G0	KGR	KGD	KGU	Line control 1
4	10100	0	0	0	0	0	0	PC	PI	PG	PR	PB	Line control 2
5	10101	ATK	ATR	ATB	0	W3	W2	W1	W0	K24	P0	DC	Screen control 1
6	10110	SC	CC	BC	0	ATH	UC	UON	UI	UG	UR	UB	Screen control 2
7	10111	0	0	0	0	Y6	Y5	Y4	Y3	Y2	Y1	Y0	Set vertical display start position
	10111	1	0	0	0	X6	X5	X4	X3	X2	X1	X0	Set horizontal display start position
8	11000	SP2	SP1	SP0	0	SCG	SCR	SCB	SBP	SBG	SBR	SBB	Sprite control
9	11001	0	SY8	SY7	0	SY6	SY5	SY4	SY3	SY2	SY1	SY0	Set sprite vertical display position
10	11010	0	SX8	SX7	0	SX6	SX5	SX4	SX3	SX2	SX1	SX0	Set sprite horizontal display position
11	11011	0	DOT	0	0	1*2	0	PR1	PR0	0	SC1	SC0	Synchronization control 1
	11011	1	0	1*2	0	DK6	DK5	DK4	DK3	DK2	DK1	DK0	Synchronization control 2
12	11100	0	0	SA7	0	SA6	SA5	SA4	SA3	SA2	SA1	SA0*2	Set transfer start address 1
	11100	1	0	SAF	0	SAE	SAD	SAC	SAB	SAA	SA9	SA8	Set transfer start address 2
13	11101	0	0	EA7	0	EA6	EA5	EA4	EA3	EA2	EA1	EA0	Set transfer end address 1
	11101	1	VBS	EAF	0	EAE	EAD	EAC	EAB	EAA	EA9	EA8	Set transfer end address 2
14	11110	—	—	—	—	—	—	—	—	—	—	—	(Reserved)
15	11111	—	—	—	—	—	—	—	—	—	—	—	(Reserved)

\*1: The SA0 and EA0 bits can only be set to "0" and "1", respectively.

\*2: Set the bits to "1".

# MB90091A

## 1. Command 0 (Set Write Address)

- **Command format**

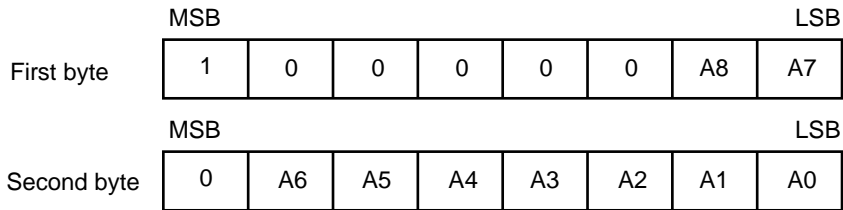

A8 to A0: VRAM address

- **Function**

Command 0 specifies the write address in display memory (VRAM). Before writing data using commands 1 and 2, use this command to determine the address to write that data at.

- **Description**

To set the VRAM address, specify the vertical column address (A8 to A5) and horizontal row address (A4 to A0). The VRAM address is incremented automatically when a character code is set (by command 2).

A8 to A0: VRAM address

Set the VRAM address.

The A8 to A5 bits specify the vertical column address; the A4 to A0 bits specify the horizontal row address.

The row address is valid between 00H to 17H.

The column address is valid between 0H to BH.

Do not set the column or row address to any value outside the above valid range.

## 2. Command 1 (Set Character Color)

### • Command format

	MSB							LSB
First byte	1	0	0	0	1	AT	BS	BI
	MSB							LSB
Second byte	0	BG	BR	BB	CI	CG	CR	CB

- AT : Specify character qualification display.  
(Specify display of a character background, blinking, inverted shading.)
- BS : Specify shaded background display.
- B1 to BB : Set a character background color.
- C1 to CB : Set a character color.

### • Function

Command 1 sets the character color and character background color and specifies character qualification display and shaded background display.

### • Description

The character color, character background color, character qualification display, and shaded background display can be set/specified for each character. Character background display, blinking, and inverted shading can be used for characters for which character qualification display is specified.

These settings are written to VRAM and applied to the display screen the moment command 2 (Set Character Code) is issued.

AT: Specify character qualification display.

(Specify display of a character background, blinking, inverted shading.)

AT = 0: Normal display (without character qualification)

This setting suppresses character background display, blinking, and inverted shading in shaded background display.

The output level at the VOB2 pin becomes "L".

AT = 1: Character qualification display

This setting enables character background display, blinking, and inverted shading in shaded background display.

"H" level output is enabled at the VOB2 pin.

Setting the command 5 (Screen Control 1) ATR bit to "1" specifies character background display.

Setting the ATB bit for command 5 (Screen Control 1) to "1" specifies blinking.

Setting both the ATK and BS bits for command 5 (Screen Control 1) to "1" specifies inverted shading.

Setting the command 6 (Screen Control 2) ATH bit to "1" sets the output level at the VOB2 pin to "H".

BS: Specify shaded background display.

BS = 0: Normal display (without shaded background display)

BS = 1: Shaded background display

Setting both the ATK and AT bits for command 5 (Screen Control 1) to "1" specifies inverted shading.

C1, CG, CR, CB: Set the character color.

B1, BG, BR, BB: Set the background color.

### 3. Command 2 (Set Character Code)

- **Command format**

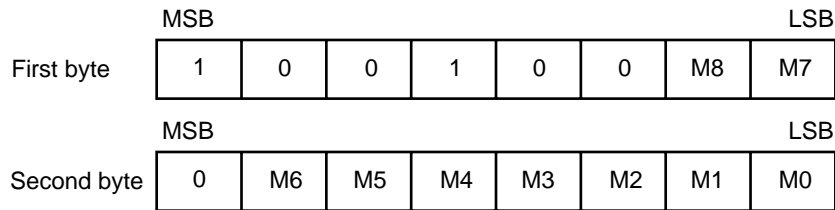

M8 to M0: Character code

- **Function**

Command 2 writes a character code to display memory (VRAM).

- **Description**

The character code data set by this command is written to display memory (VRAM) along with the character color, character background color, shaded background display, and character qualification display data set by command 1 (Set Character Color).

Character code is represented by nine bits from M8 to M0, enabling use of 512 different character patterns from 000H to 1FFFH stored in internal or external font ROM.

Upon completion of writing data, the write address is incremented automatically.

M8 to M0: Character code

000H to 1FFFH can be set to specify 512 different characters.

## 4. Command 3 (Line Control 1)

- Command format

	MSB				LSB			
First byte	1	0	0	1	1	X9	X8	X7
	MSB				LSB			
Second byte	0	0	G2	G1	G0	KGR	KGD	KGU

X9 to X7 : Line horizontal display start position

G2 to G0 : Character size

KGR : Specify shaded background left/right joint display

KGD : Specify shaded background downward joint display

KGU : Specify shaded background upward joint display

- Function

Command 3 sets the line horizontal display start position, character size, and shaded background joint display for each line.

- Description

Line control data set by this command is applied to the display screen when command 4 (Line Control 2) is issued.

X9 to X7: Line horizontal display start position

The offset value can be set for each line, relative to the horizontal display start position set by command 7-1 (Set Horizontal Display Start Position).

The valid range of values is 0 to 7H (In 2-character units: 0 to 14 characters)

- Line horizontal display start position

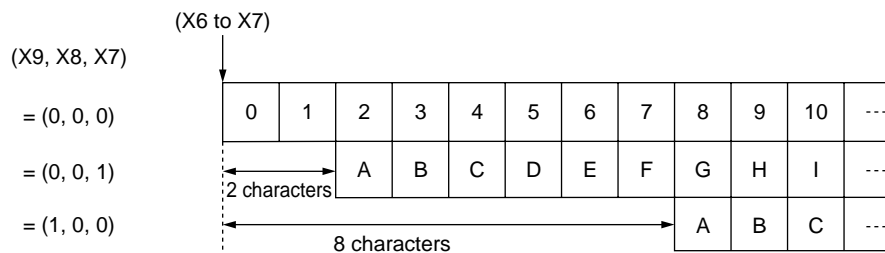

# MB90091A

## G2 to G0: Character size

G2	G1	G0	Character size
0	0	0	Normal
0	0	1	Single height x double width
0	1	0	Double height x single width
0	1	1	Double height x double width
1	0	0	Single height x quadruple width
1	0	1	(Setting prohibited)
1	1	0	Double height x quadruple width
1	1	1	(Setting prohibited)

Note: The horizontal display start position for “double width x single or double height” display is shifted three dots to the right from that for normal-size display. The horizontal display start position for “quadruple width x single or double height” display is shifted nine dots to the right from that for normal-size display. Be careful when displaying normal-size and enlarged lines at the same time.

KGR: Specify shaded background left/right joint display.

KGR = 0: Display the shaded backgrounds horizontally adjacent to each other, joined together (without display their adjacent, vertical sides).

KGR = 1: Display the shaded backgrounds horizontally adjacent to each other, separately for each character (while displaying their adjacent, vertical sides).

KGD: Specify shaded background downward joint display.

KGD = 0: Display the shaded background including its lower side.

KGD = 1: Display the shaded background excluding its lower side.

KGU: Specify shaded background upward joint display

KGU = 0: Display the shaded background including its lower side.

KGU = 1: Display the shaded background excluding its lower side.



## 5. Command 4 (Line Control 2)

- **Command format**

	MSB							LSB	
First byte	1	0	1	0	0	0	0	0	
	MSB								LSB
Second byte	0	0	0	PC	PI	PG	PR	PB	

PC : Control the pattern background color.  
 PI to PB : Set the pattern background color.

- **Function**

Command 4 sets the pattern background color and controls it between color and monochrome modes.

- **Description**

The data set by this command is written to the column RAM specified by the VRAM column address set by command 0 (Set Write Address), along with the line control data set by command 3 (Line Control 1).

The Line Control 1 and 2 data is applied to the display screen and the column address is incremented the moment this command is issued.

PC: Control the pattern background color.

PC = 0: Display the pattern background in monochrome.

During the pattern background color output period, the COLOR pin remains at the "L" output level.

PC = 1: Display the pattern background in color.

During the pattern background color output period, the COLOR pin remains at the "H" output level.

PI, PG, PR, PG: Set the pattern background color.

# MB90091A

## 6. Command 5 (Screen Control 1)

- - Command format

	MSB						LSB	
First byte	1	0	1	0	1	ATK	ATR	ATB
	MSB						LSB	
Second byte	0	W3	W2	W1	W0	K24	P0	DC

ATK : Control inverted shading.  
ATR : Control character background display.  
ATB : Control blinking.  
W3 to W0: Control the line spacing.  
K24 : Specify the shadow frame size.  
P0 : Control the pattern background.  
DC : Control displ

- **Function**

Command 5 controls the display screen.

- **Description**

ATK: Control inverted shading.

ATK = 0: Normal display  
Inverted display is disabled.

ATK = 1: Enable inverted display.  
This mode displays those characters in reverse video (with the inverted, shaded background) for which the BS and AT bits for command 1 (Set Character Color) have been both set to "1".

ATR: Control character background display.

ATR = 0: Normal display  
Character background display is disabled.

ATR = 1: Enable character background display.  
Character background display applies to those characters for which the BS and AT bits for command 1 (Set Character Color) have been set to "0" and "1", respectively.

ATB: Control blinking.

ATB = 0: Normal display  
Blinking is disabled.

ATB = 1: Enable blinking.  
This mode causes those characters to blink for which the AT bit for command 1 (Set Character Color) has been set to "1".

W3 to W0: Control the line spacing.

Set the line spacing in 2-dot units.  
0 to 30 dots can be specified.

K24: Specify the shadow frame size.

K24 = 0: Set the height of shadow frames for shaded background display to 32 dots.

K24 = 1: Set the height of shadow frames for shaded background display to 24 dots.

P0: Control the pattern background.

P0 = 0: Set pattern background mode "pattern background 0".

ROM data "1" is displayed as a character dot.

P0 = 1: Set pattern background mode "pattern background 1".

Character and pattern background dots are separately generated automatically from a ROM data array.

Note: Note: As the pattern background mode, set the mode used when the relevant font was designed.

DC: Control display.

DC = 0: Disable output operation for displaying characters and sprite characters.

Only the screen background color can be output.

DC = 1: Enable output operation for displaying characters and sprite characters.

The screen background color can also be output.

# MB90091A

## 7. Command 6 (Screen Control 2)

- **Command format**

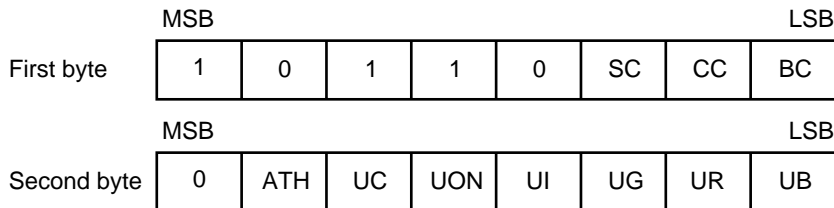

- SC : Control the sprite character color.
- CC : Control the character color.
- BC : Control the character background.
- ATH : Control specified character output.
- UC : Control the screen background color.
- UON : Control screen background color output.
- UI to UB : Set the screen background color.

- **Function**

Command 6 specifies the character color, character background color, screen background color, sprite character color, color/monochrome mode, specified character output. This command also enables or disables screen background color output and sets the screen background color.

- **Description**

SC: Control the sprite character color.

SC = 0: Display the sprite character and sprite pattern background in monochrome.

During the sprite character/pattern background output period, the COLOR pin outputs the “L” level signal.

SC = 1: Display the sprite character and sprite pattern background in color.

During the sprite character/pattern background output period, the COLOR pin outputs the “H” level signal.

CC: Control the character color.

CC = 0: Display characters in monochrome.

During the character output period, the COLOR pin outputs the “L” level signal.

CC = 1: Display characters in color.

During the character output period, the COLOR pin outputs the “H” level signal.

BC: Control the character background.

BC = 0: Display the character background in monochrome.

During the character background output period, the COLOR pin outputs the “L” level signal.

BC = 1: Display the character background in color.

During the character background output period, the COLOR pin outputs the “H” level signal.

Note: Note: Use an external circuit to control display mode between monochrome and color using the COLOR pin.

ATH: Control specified character output.

ATH = 0: Normal display

The VOB2 pin outputs the “L” level signal.

ATH = 1: The VOB2 pin outputs the “H” level signal during the output period (24 x 32b dots period) for those characters for which the AT bit for command 1 (Set Character Color) has been set to 1.

Note: Note: Use an external circuit to handle the VOB2 pin signal, allowing the specified character to be displayed in halfbright, translucent, and other special display mode.

UC: Control the screen background color.

UC = 0: Display the screen background in monochrome.

During the screen background output period, the COLOR pin outputs the “L” level signal.

UC = 1: Display the screen background in color.

During the screen background output period, the COLOR pin outputs the “H” level signal.

UON: Control screen background color output.

UON = 0: Prevent the screen background color from being output.

During the screen background color output period, the IOOUT, GOOUT, ROOUT, BOOUT, and VOB1 pins output “L” level signals.

UON = 1: Output the screen background color.

During the screen background color output period, the IOOUT, GOOUT, ROOUT, and BOOUT pins output the screen background color and the VOB1 pin outputs the “L” level signal.

UI, UG, UR, UB: Set the screen background color.

## 8. Command 7-0 (Set Vertical Display Start Position)

- Command format

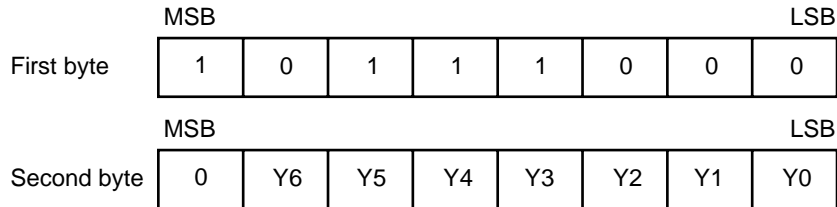

Y6 to Y0: Set the vertical display start position.

- Function

Command 7-0 sets the vertical display start position.

- Description

Y6 to Y0: Set the vertical display start position.

Set the position to start vertical display. The valid range of values is 00H to 7FH for setting in 2-dot units (0 to 254 dots).

The following illustrates the relationship between the vertical display start position and the \*VSYNC signal.

- Vertical display start position

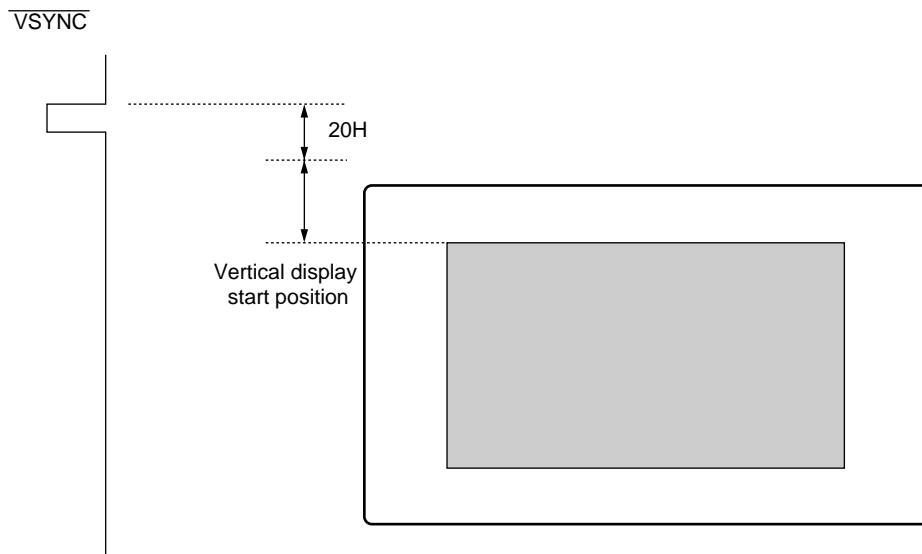

## 9. Command 7-1 (Set Horizontal Display Start Position)

- Command format

	MSB							LSB	
First byte	1	0	1	1	1	1	0	0	
								MSB	LSB
Second byte	0	X6	X5	X4	X3	X2	X1	X0	

X6 to X0: Set the horizontal display start position.

- Function

Command 7-0 sets the horizontal display start position.

- Description

X6 to X0: Set the horizontal display start position.

Set the position to start horizontal display. The valid range of values is 00H to 7FH for setting in 8-dot units.

The following illustrates the relationship between the horizontal display start position and the  $\overline{\text{HSYNC}}$  signal.

- Horizontal display start position

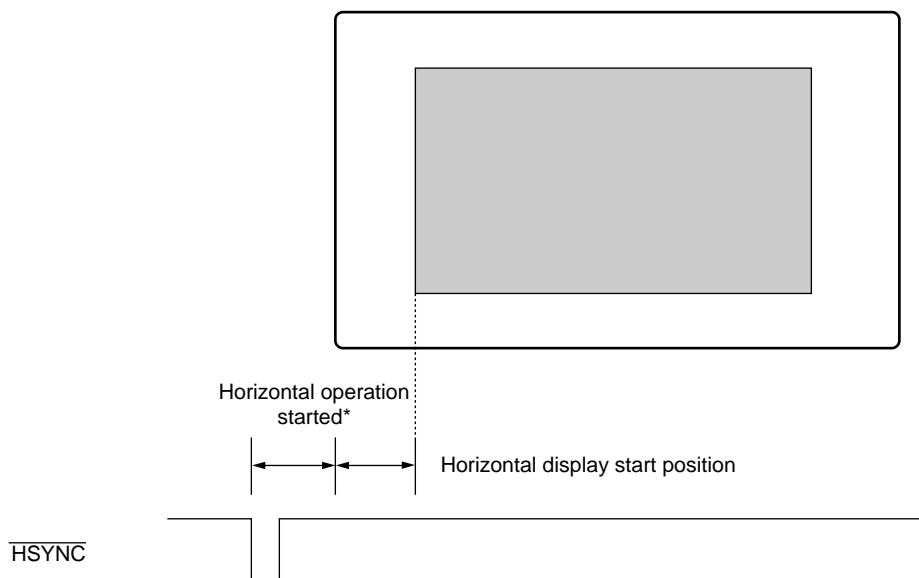

\* : Character size: About 100-dot clock for normal display  
 Double or quadruple width display is shifted further to the right from the above value.  
 For details, see Page 24

# MB90091A

## 10.Command 8 (Sprite Control)

- **Command format**

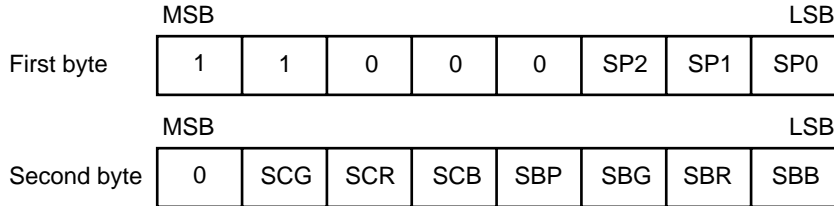

SP2 to SP0 : Set sprite character code.  
 SCG to SCB : Set the sprite character color.  
 SBP : Set the sprite pattern background.  
 SBG to SBB : Set the sprite pattern background color.

- **Function**

Command 8 sets the sprite character code, character color, pattern background display, and pattern background color.

- **Description**

SP2 to SP0: Set sprite character code.

Specify the sprite character type from among character codes 1F8H to 1FFH representing eight character types.

SP2	SP1	SP0	Sprite character
0	0	0	1F8H
0	0	1	1F9H
0	1	0	1FAH
0	1	1	1FBH
1	0	0	1FCH
1	0	1	1FDH
1	1	0	1FEH
1	1	1	1FFH

SCG to SCB: Set the sprite character color.

SBP: Control sprite pattern background display.

SBP = 0: Display no pattern background for the sprite.

This display mode is "No pattern background" (displaying only those character dots displayed in "Pattern background 1" mode).

SBP = 1: Display a pattern background for the sprite.

This display mode is "Pattern background 1".

SBG to SBB: Set the sprite pattern background color.



## 11.Command 9 (Set Sprite Vertical Display Position)

- **Command format**

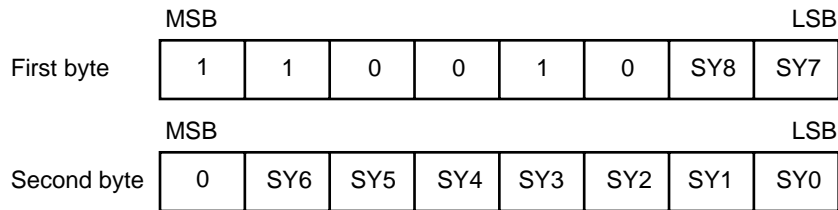

SY8 to SY0: Set the sprite vertical display position.

- **Function**

Command 9 sets the sprite character vertical display position.

- **Description**

SY8 to SY0: Set the sprite vertical display position.

Set the vertical display position of the sprite character.

The valid range of values is 000H to 1FFH for setting in 2-dot units (0 to 1022 dots).

The following illustrates the relationship between the sprite vertical display position and the  $\overline{\text{VSYNC}}$  signal.

- **Sprite vertical display position**

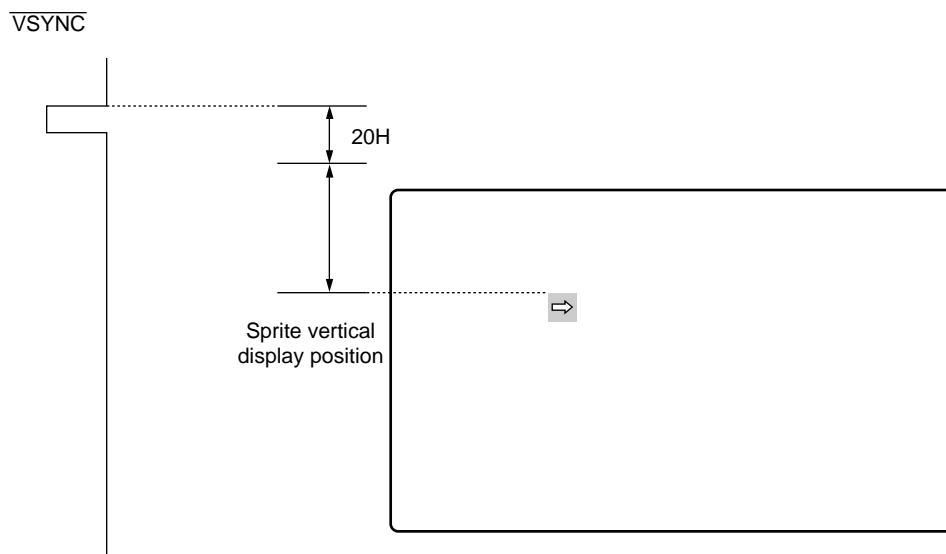

## 12.Command 10 (Set Sprite Horizontal Display Position)

- **Command format**

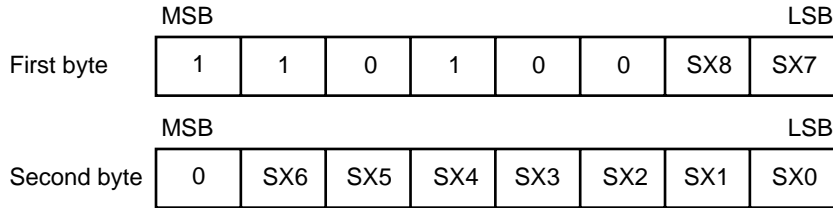

SX8 to SX0: Set the sprite horizontal display position.

- **Function**

Command 10 sets the sprite character horizontal display position.

- **Description**

SY8 to SY0: Set the sprite horizontal display position.

Set the horizontal display position of the sprite character.

The valid range of values is 000H to 1FFH for setting in 2-dot units (0 to 1022 dots).

Setting these bits to 000H disables sprint display.

The following illustrates the relationship between the sprite horizontal display position and the  $\overline{\text{HSYNC}}$  signal.

- **Sprite horizontal display position**

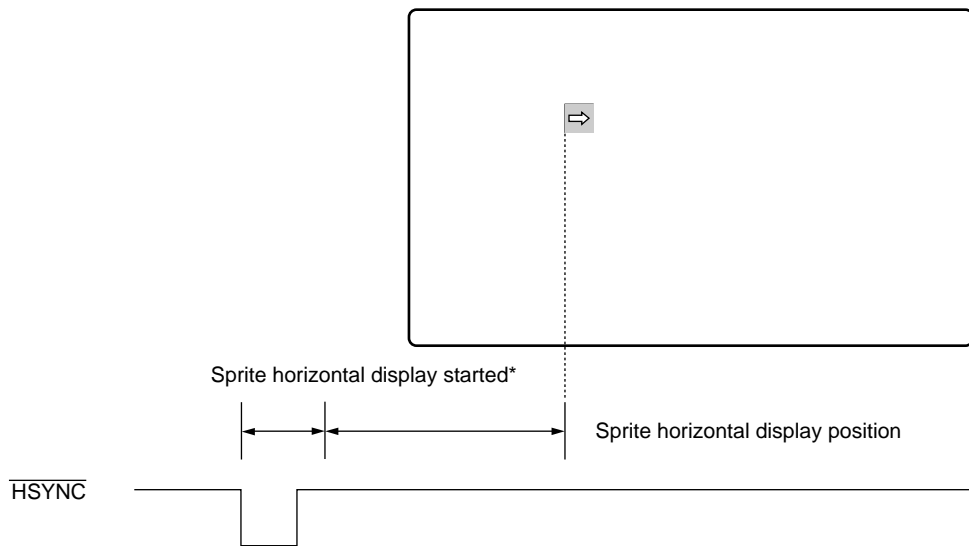

\* : About 80-dot clock.

## 13.Command 11-0 (Synchronization Control 1)

- **Command format**

	MSB							LSB
First byte	1	1	0	1	1	0	DOT	0
							MSB	LSB
Second byte	0	1*	0	PR1	PR0	0	SC1	SC0

DOT : Control dot clock output.  
 PR1, PR0 : Control the prescaler.  
 SC1, SC0 : Control the scan system.  
 \*: Set this bit to "1".

- **Function**

Command 10 controls synchronization.

- **Description**

DOT: Control dot clock output.

DOT = 0: Do not output the dot clock signal to the DOCK pin.

DOT = 1: Output the dot clock signal to the dock pin.

PR1, PR0: Control the prescaler.

PR1	PR0	Prescaler operation	Corresponding dot clock
0	0	÷2	25.0 to 42.0 MHz
0	1	÷3	16.7 to 28.3 MHz
1	0	÷5	10.0 to 17.0 MHz
1	1	÷6	8.4 to 14.1 MHz

SC1, SC0: Control the scan system.

SC1	SC2	Scan system
0	0	Interlaced scan
0	1	Noninterlaced scan
1	0	Step scan
1	1	(Setting prohibited)

Interlaced or step scan operation requires the field control signal to be input to the EVEN pin.

# MB90091A

## 14.Command 11-1 (Synchronization control 2)

- **Command format**

	MSB							LSB
First byte	1	1	0	1	1	1	0	1*
	MSB							LSB
Second byte	0	DK6	DK5	DK4	DK3	DK2	DK1	DK0

DK6 to DK0: Control dot clock signals.

\*: Set this bit to "1".

- **Function**

Command 11-1 controls dot clock signals.

- **Description**

DK6 to DK0: Control dot clock signals.

Set the divisor in 16-dot units for generating dot clock signals by dividing the FH (horizontal frequency). The valid range of values is 00H to 7FH.

This enables the horizontal frequency to be divided by up to 2032.

## 15.Command 12-0 (Set Transfer Start Address 1)

- **Command format**

	MSB							LSB
First byte	1	1	1	0	0	0	0	SA7
	MSB							LSB
Second byte	0	SA6	SA5	SA4	SA3	SA2	SA1	SA0*

SA7 to SA0: Lower address for starting transfer from command table ROM

\*: The SA0 bit can only be set to "0".

- **Function**

Command 12-0 sets the lower address for starting transfer of data from command table ROM.

- **Description**

SA7 to SA0: Lower address for starting transfer from command table ROM

These bits can be set only to an even address. The SA0 bit is set internally to "0".

Data transfer from ROM is initiated by issuing command 13-1 (Set Transfer End Address 2).

## 16.Command 12-1 (Set Transfer Start Address 2)

- **Command format**

	MSB							LSB
First byte	1	1	1	0	0	1	0	SAF
	MSB							LSB
Second byte	0	SAE	SAD	SAC	SAB	SAA	SA9	SA8

SAF to SA8: Upper address for starting transfer from command table ROM

- **Function**

Command 12-1 sets the upper address for starting transfer of data from command table ROM.

- **Description**

SAF to SA8: Upper address for starting transfer from command table ROM

Data transfer from ROM is initiated by issuing command 13-1 (Set Transfer End Address 2).

## 17.Command 13-0 (Set Transfer End Address 1)

- **Command format**

	MSB							LSB
First byte	1	1	1	0	1	0	0	EA7
	MSB							LSB
Second byte	0	EA6	EA5	EA4	EA3	EA2	EA1	EA0*

EA7 to EA0: Lower address for ending transfer from command table ROM

\*: The EA0 bit can only be set to "1".

- **Function**

Command 13-0 sets the lower address for ending transfer of data from command table ROM.

- **Description**

EA7 to EA0: Lower address for ending transfer from command table ROM

These bits can be set only to an odd address. The EA0 bit is set internally to "1".

Data transfer from ROM is initiated by issuing command 13-1 (Set Transfer End Address 2).

# MB90091A

## 18.Command 13-1 (Set Transfer End Address 2)

- **Command format**

	MSB						LSB
First byte	1	1	1	0	1	1	VBS EAF
	MSB						LSB
Second byte	0	EAE	EAD	EAC	EAB	EAA	EA9 EA8

VBS : Control the ROM transfer period.  
EAF to EA8 : Upper address for ending transfer from command table ROM

- **Function**

Command 13-1 sets the upper address for ending data transfer from command table ROM and specifies the ROM transfer period to initiate ROM data transfer.

- **Description**

VBS: Control the ROM transfer period.

VBS = 0: Transfer data during the horizontal and vertical blanking intervals.

VBS = 1: Transfer data during the vertical blanking interval.

EAF to EA8: Upper address for ending transfer from command table ROM

Issuing this command initiates command table ROM transfer operation and sets the TRE pin output to the “H” level. Upon completion of transfer operation, the TRE pin output becomes the “L” level.

When the TRE pin output is at the “H” level, do not issue command 0 to 4, 11, 12, or 13 by serial input (commands 5 to 10 can be issued).

## ■ APPLICATION EXAMPLES

This section provides useful information for designing application systems using the MB90091A.

### 1. Power Supply

The MB90091A pairs of digital ( $V_{cc}$ ,  $V_{ss}$ ) and analog ( $AV_{cc}$ ,  $AV_{ss}$ ) power-supply and ground pins. The  $V_{cc}$  and  $AV_{cc}$  power-supply pins are independent of each other; the  $V_{ss}$  and  $AV_{ss}$  ground pins are internally common.

Since the analog power supply supplies power and control voltage to the internal VCO, it requires special consideration separately from the digital power supply.

In general, pay attention to the following points:

- Design the system so that the ground and power supply impedances are suppressed. In addition, the ground line should be laid out on a ground plane including peripheral analog circuits.
- The digital ( $V_{cc}$ ,  $V_{ss}$ ) and analog ( $AV_{cc}$ ,  $AV_{ss}$ ) power supplies must be separated from each other. The  $V_{cc}$  and  $AV_{cc}$  pins, and the  $V_{ss}$  and  $AV_{ss}$  pins must not have a potential different in between.
- To supply digital and analog power from the same power source, separately route the wires from the source and use a choke coil to prevent digital noise from interfering with the analog subsystem via the power source.
- Insert a relatively high-capacity (20 to 100  $\mu\text{F}$ ) electrolytic capacitor as a bypass capacitor between the power supply and ground, separately between the digital and analog subsystems.

### 2. Interface with a Microcontroller or Microcomputer

Operation of the MB90091 is controlled by a micro (controller or microcomputer). The MB90091 interfaces with the micro by 8-bit serial transfer using four signal liens as shown below:

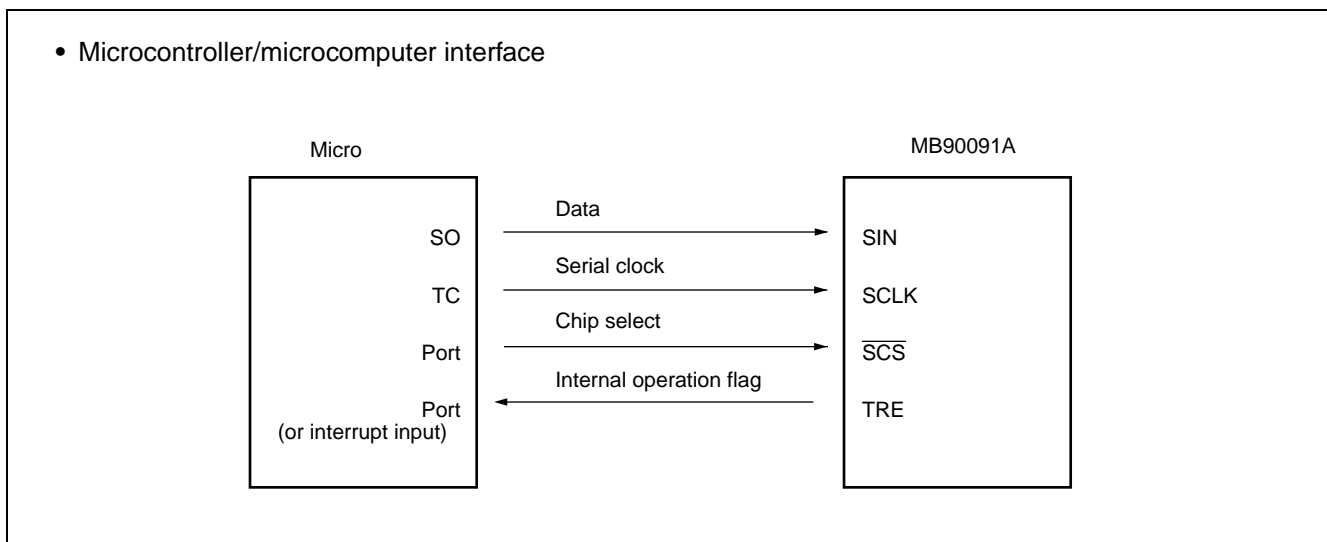

Although most micros can be used for controlling the MB90091A, the one with an 8-bit serial interface (serial port) is recommended because it can be connected directly to the MB90091A for high-speed command/data transfer by means of hardware. (The micro with a 4-bit serial interface can transfer data in two separate blocks.)

Note: Keep in mind that some micros cannot be connected to the serial port depending on the type. Fujitsu 4- and 8-bit microcontrollers have no problem with the MB90091A.

# MB90091A

## 3. Treatment of Unused Pins

Pins unused on the MB90091A must be treated as follows.

### • Treatment of unused pins

Pin No.		Pin name	I/O	Treatment
DIP	QFP			
8	1	$\overline{\text{HSYNC}}$	I	—
9	2	$\overline{\text{VSYNC}}$	I	—
10	3	EVEN	I	Connect the pin to Vcc or leave it open.
11	4	FLTIN	O	—
13	6	FLTOUT	I	—
15	8	$\overline{\text{FH}}$	O	Leave the pin open.
16	9	$\overline{\text{RESET}}$	I	Connect the pin to Vcc or leave it open.
18	11	RD0	I	Connect the pin to Vcc or leave it open.
19	12	RD1	I	Connect the pin to Vcc or leave it open.
20	13	RD2	I	Connect the pin to Vcc or leave it open.
21	14	RD3	I	Connect the pin to Vcc or leave it open.
22	15	RD4	I	Connect the pin to Vcc or leave it open.
23	16	RD5	I	Connect the pin to Vcc or leave it open.
24	17	RD6	I	Connect the pin to Vcc or leave it open.
25	18	RD7	I	Connect the pin to Vcc or leave it open.
26	19	TEST	I	Connect the pin to Vss.
28	21	TA16	O	Leave the pin open.
29	22	TA17	O	Leave the pin open.
30	23	TA18	O	Leave the pin open.
31	24	$\overline{\text{FCS}}$	O	Leave the pin open.
32	25	$\overline{\text{TCS}}$	O	Leave the pin open.
33	26	RA0	O	Leave the pin open.
34	27	RA1	O	Leave the pin open.
35	28	RA2	O	Leave the pin open.
36	29	RA3	O	Leave the pin open.
38	31	RA4	O	Leave the pin open.
40	33	RA5	O	Leave the pin open.
41	34	RA6	O	Leave the pin open.
42	35	RA7	O	Leave the pin open.
43	36	RA8	O	Leave the pin open.
44	37	RA9	O	Leave the pin open.
45	38	RA10	O	Leave the pin open.
46	39	RA11	O	Leave the pin open.
48	41	RA12	O	Leave the pin open.
49	42	RA13	O	Leave the pin open.
50	43	RA14	O	Leave the pin open.
51	44	RA15	O	Leave the pin open.
52	45	TSEL	I	—
53	46	FSEL	I	—
54	47	SCLK	I	—
55	48	SIN	I	—

(Continued)



(Continued)

Pin No.		Pin name	I/O	Treatment
DIP	QFP			
56	49	$\overline{SCS}$	I	—
58	51	TRE	O	Leave the pin open.
59	52	ROUT	O	Leave the pin open.
60	53	GOUT	O	Leave the pin open.
61	54	BOUT	O	Leave the pin open.
62	55	IOUT	O	Leave the pin open.
63	56	VOB1	O	Leave the pin open.
64	57	VOB2	O	Leave the pin open.
1	58	COLOR	O	Leave the pin open.
2	59	DOCK	O	Leave the pin open.
4	61	TESTCK	I	Connect the pin to Vcc or leave it open.
5	62	TESTSW	I	Connect the pin to Vcc.
6	63	$\overline{HBLNK}$	I	Connect the pin to Vcc or leave it open.
7	64	$\overline{VBLNK}$	I	Connect the pin to Vcc or leave it open.

# MB90091A

## APPLIED CIRCUIT EXAMPLE

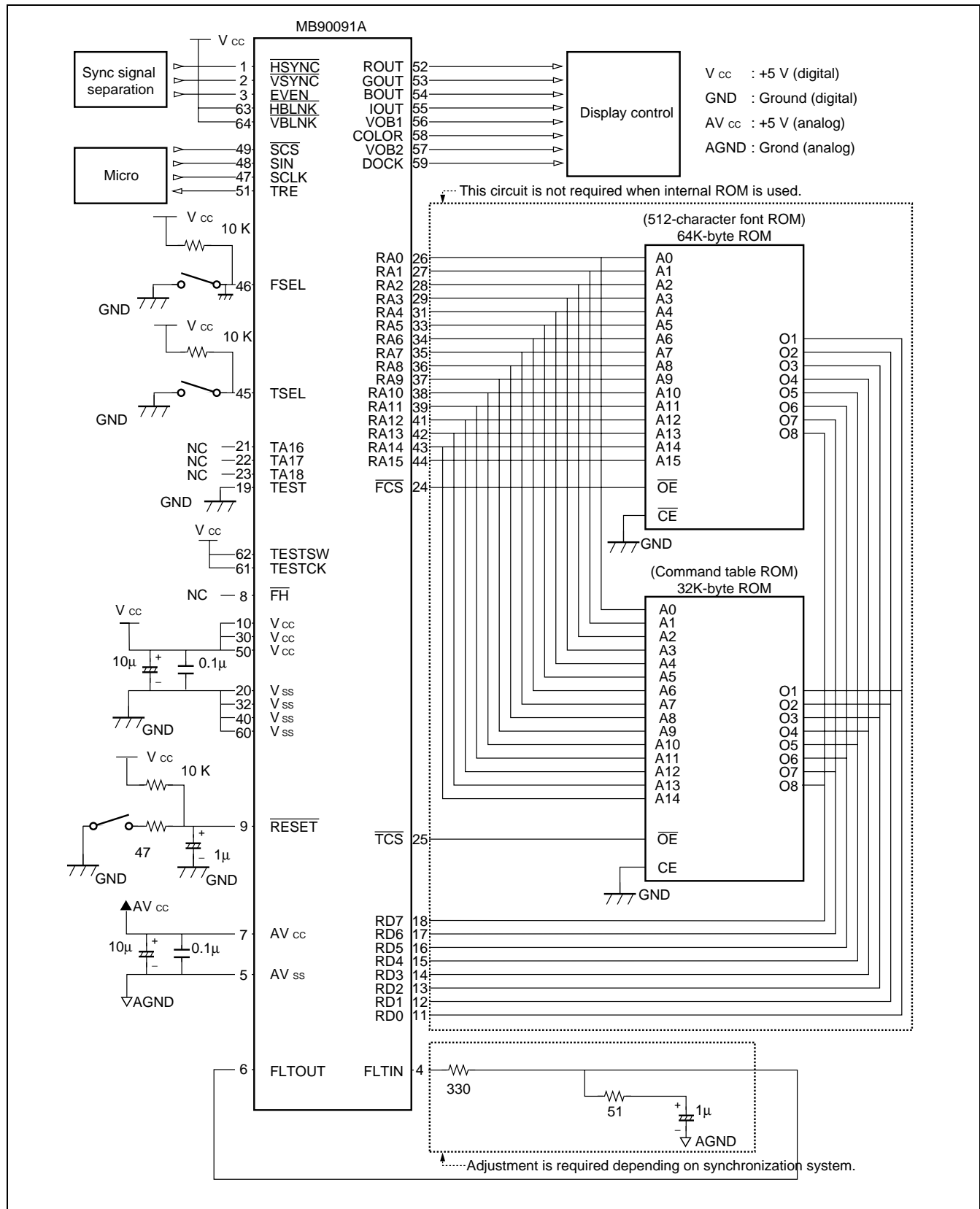

## ■ ORDERING INFORMATION

Part number	Package	Remarks
MB90091AP	64-pin plastic SH-DIP (DIP-64P-M01)	
MB90091APF	64-pin plastic QFP (FPT-64P-M06)	

# MB90091A

## ■ PACKAGE DIMENSIONS

64 pin, Plastic SH-DIP  
(DIP-64P-M01)

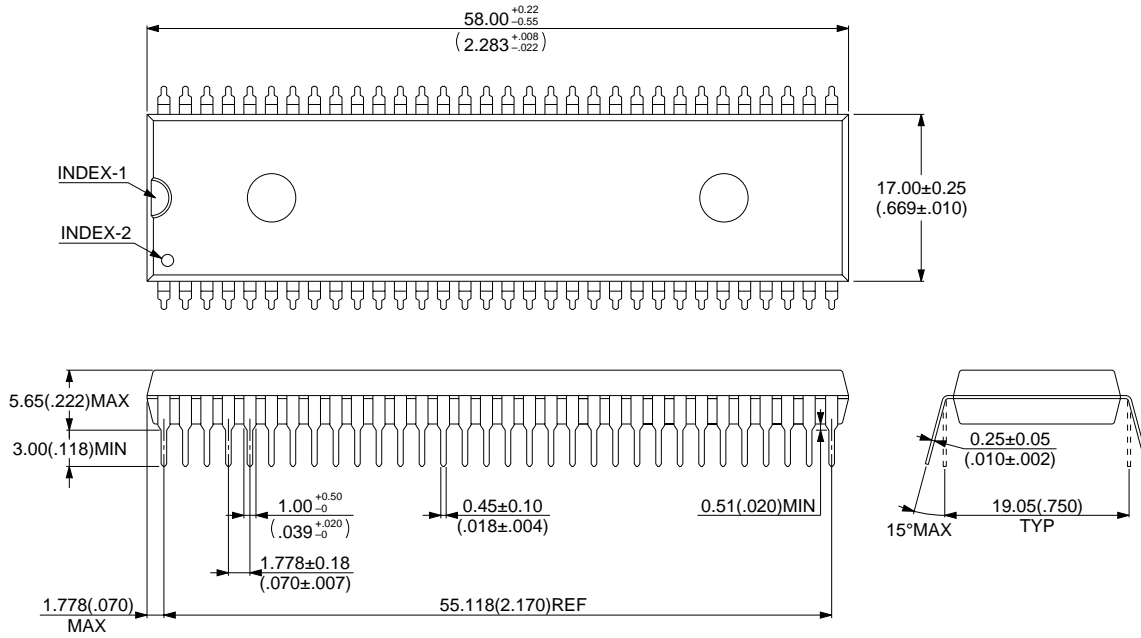

© 1994 FUJITSU LIMITED D64001S-3C-4

Dimensions in mm (inches).

(Continued)

64 pin, Plastic QFP  
(FPT-64P-M06)

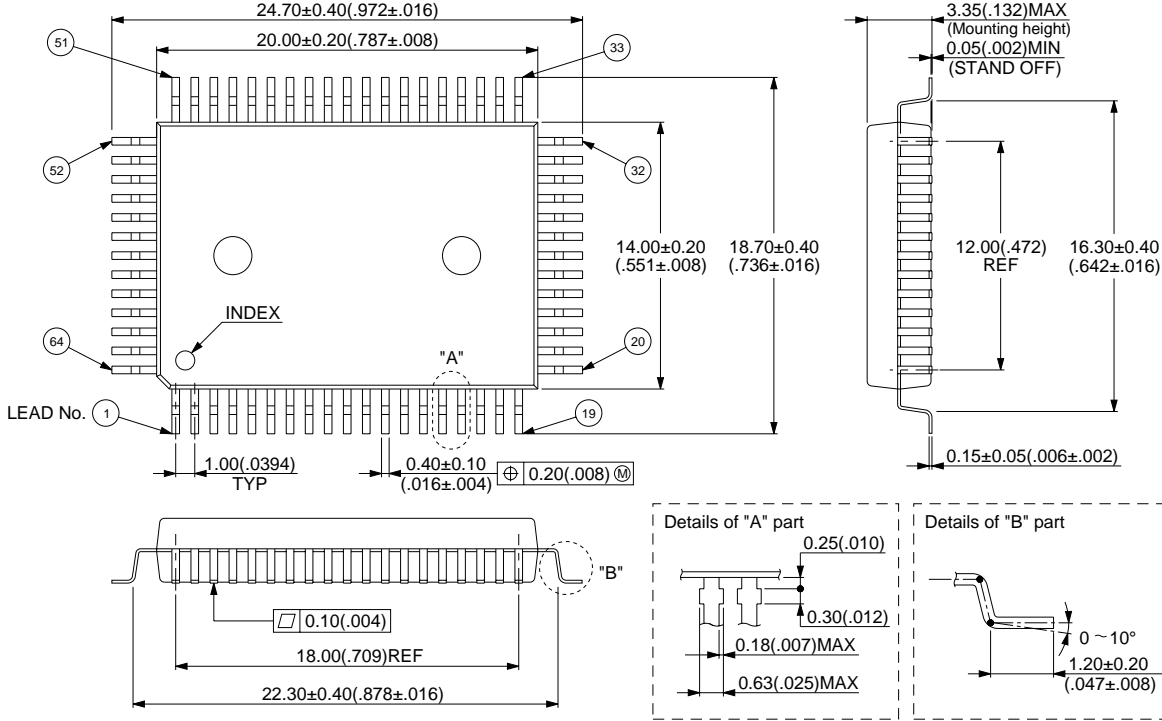

© 1994 FUJITSU LIMITED F64013S-3C-2

Dimensions in mm (inches).

## FUJITSU LIMITED

*For further information please contact:*

### **Japan**

FUJITSU LIMITED  
Corporate Global Business Support Division  
Electronic Devices  
KAWASAKI PLANT, 4-1-1, Kamikodanaka  
Nakahara-ku, Kawasaki-shi  
Kanagawa 211-88, Japan  
Tel: (044) 754-3753  
Fax: (044) 754-3329

### **North and South America**

FUJITSU MICROELECTRONICS, INC.  
Semiconductor Division  
3545 North First Street  
San Jose, CA 95134-1804, U.S.A.  
Tel: (408) 922-9000  
Fax: (408) 432-9044/9045

### **Europe**

FUJITSU MIKROELEKTRONIK GmbH  
Am Siebenstein 6-10  
63303 Dreieich-Buchsschlag  
Germany  
Tel: (06103) 690-0  
Fax: (06103) 690-122

### **Asia Pacific**

FUJITSU MICROELECTRONICS ASIA PTE. LIMITED  
#05-08, 151 Lorong Chuan  
New Tech Park  
Singapore 556741  
Tel: (65) 281 0770  
Fax: (65) 281 0220

All Rights Reserved.

The contents of this document are subject to change without notice. Customers are advised to consult with FUJITSU sales representatives before ordering.

The information and circuit diagrams in this document presented as examples of semiconductor device applications, and are not intended to be incorporated in devices for actual use. Also, FUJITSU is unable to assume responsibility for infringement of any patent rights or other rights of third parties arising from the use of this information or circuit diagrams.

FUJITSU semiconductor devices are intended for use in standard applications (computers, office automation and other office equipment, industrial, communications, and measurement equipment, personal or household devices, etc.).

#### **CAUTION:**

Customers considering the use of our products in special applications where failure or abnormal operation may directly affect human lives or cause physical injury or property damage, or where extremely high levels of reliability are demanded (such as aerospace systems, atomic energy controls, sea floor repeaters, vehicle operating controls, medical devices for life support, etc.) are requested to consult with FUJITSU sales representatives before such use. The company will not be responsible for damages arising from such use without prior approval.

Any semiconductor devices have inherently a certain rate of failure. You must protect against injury, damage or loss from such failures by incorporating safety design measures into your facility and equipment such as redundancy, fire protection, and prevention of over-current levels and other abnormal operating conditions.

If any products described in this document represent goods or technologies subject to certain restrictions on export under the Foreign Exchange and Foreign Trade Control Law of Japan, the prior authorization by Japanese government should be required for export of those products from Japan.