

# Am2847 • Am2896

## Quad 80-Bit and Quad 96-Bit Static Shift Registers

### Complex Digital Integrated Circuits

#### Distinctive Characteristics

- Plug-in replacement for 2532B, TMS3120, TMS 3409, MK1007, 3347
- Internal recirculates on each register
- Single TTL compatible clock
- Outputs sink two TTL loads
- Operation guaranteed from DC to 3 MHz
- 100% reliability assurance testing in compliance with MIL-STD-883

#### FUNCTIONAL DESCRIPTION

The Am2847 and Am2896 are quad 80-and 96-bit static MOS shift registers. Each device contains four shift registers, each with a TTL compatible input, output, and recirculate control. When the RC signal is LOW, the corresponding register accepts data from its data input; when RC is HIGH, the data at the register output is written back in at the input. The four registers are driven by a common TTL compatible clock input. The registers shift on the HIGH-to-LOW transition of the clock. Storage is dynamic while the clock is HIGH and static while the clock is LOW, so the clock may be stopped indefinitely in the LOW state. Each register output can drive two TTL unit loads.

#### LOGIC SYMBOL

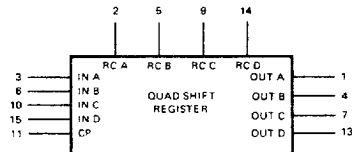

V<sub>SS</sub> = Pin 16  
V<sub>DD</sub> = Pin 8  
V<sub>GG</sub> = Pin 12

#### LOGIC BLOCK DIAGRAM (One Register Shown)

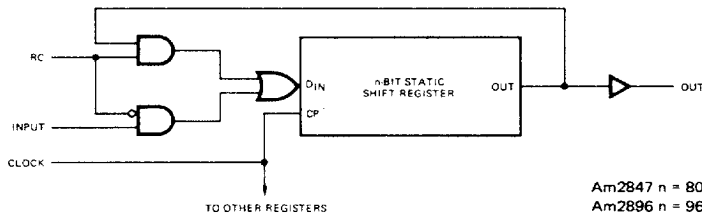

Am2847 n = 80  
Am2896 n = 96

#### ORDERING INFORMATION

##### Am2847 Quad 80-Bit

Package Type	Temperature Range	Order Number
16-Pin Molded DIP	0°C to +70°C	AM2847PC
16-Pin Hermetic DIP	0°C to +70°C	AM2847DC
16-Pin Hermetic DIP	-55°C to +125°C	AM2847DM

##### Am2896 Quad 96-Bit

16-Pin Molded DIP	0°C to +70°C	AM2896PC
16-Pin Hermetic DIP	0°C to +70°C	AM2896DC
16-Pin Hermetic DIP	-55°C to +125°C	AM2896DM

#### CONNECTION DIAGRAM Top View

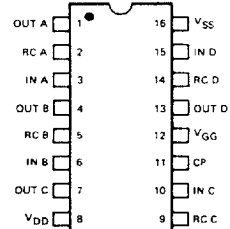

Note: Pin 1 is marked for orientation.

8077984 0000115 5T3

13

**MAXIMUM RATINGS** (Above which the useful life may be impaired)

Storage Temperature	-65°C to +160°C
Temperature (Ambient) Under Bias	-55°C to +125°C
V <sub>DD</sub> Supply Voltage	V <sub>SS</sub> -10V to V <sub>SS</sub> +0.3V
V <sub>GG</sub> Supply Voltage	V <sub>SS</sub> -20V to V <sub>SS</sub> +0.3V
DC Input Voltage	V <sub>SS</sub> -20V to V <sub>SS</sub> +0.3V

**OPERATING RANGE**

Part Number	Ambient Temperature	V <sub>SS</sub>	V <sub>DD</sub>	V <sub>GG</sub>
Am2847DM Am2896DM	-55°C to +125°C	5.0V ±5%	0V	-12V ±5%
Am2847PC, DC Am2896PC, DC	0°C to +70°C	5.0V ±5%	0V	-12V ±5%

**ELECTRICAL CHARACTERISTICS OVER OPERATING RANGE** (Unless Otherwise Noted)

Parameters	Description	Test Conditions	Min.	Typ. (Note 1)	Max.	Units
V <sub>OH</sub>	Output HIGH Voltage	I <sub>OH</sub> = -0.5mA	2.4			Volts
V <sub>OL</sub>	Output LOW Voltage	I <sub>OL</sub> = 3.2mA 0°C to 70°C			0.4	Volts
		I <sub>OL</sub> = 2.4mA -55° to 125°C				
V <sub>IH</sub>	Input HIGH Level	Guaranteed input logical HIGH voltage for all inputs	V <sub>SS</sub> -1.0		V <sub>SS</sub> +0.3	Volts
V <sub>IL</sub>	Input LOW Level	Guaranteed input logical LOW voltage for all inputs	V <sub>SS</sub> -18.5		0.8	Volts
I <sub>LI</sub>	Input Leakage Current	V <sub>IN</sub> = -5.0V, all other pins connected to V <sub>SS</sub>			1.0	μA
I <sub>IL</sub>	Input LOW Current	V <sub>IN</sub> = 0.4V		-1.0	-1.6	mA
I <sub>IH</sub>	Input HIGH Current	V <sub>IN</sub> = V <sub>SS</sub> -1.0V	-0.1			mA
I <sub>DD</sub>	V <sub>DD</sub> Power Supply Current	Output open, f = 2.5MHz	0°C to 70°C	25	35	mA
			-55°C to 125°C			
I <sub>GG</sub>	V <sub>GG</sub> Power Supply Current	Output open, f = 2.5MHz	0°C to 70°C	10	15	
			-55°C to 125°C		20	

Note: 1. Typical Limits are at V<sub>SS</sub> = 5.0V, V<sub>GG</sub> = -12V, 25°C ambient.

**SWITCHING CHARACTERISTICS OVER OPERATING RANGE** (Unless Otherwise Noted)

Parameters	Description	Test Conditions	Min.	Typ.	Max.	Units
f	Clock Frequency	0°C to 70°C	0		3.0	MHz
		-55°C to 125°C			2.5	
t <sub>0pWH</sub>	Clock HIGH Time	0°C to 70°C	140		100	μs
		-55°C to 125°C	150		10	
t <sub>0pWL</sub>	Clock LOW Time	0°C to 70°C	140		∞	μs
		-55°C to 125°C	180			
t <sub>r</sub> , t <sub>f</sub>	Clock Rise and Fall Times		10		200	ns
t <sub>s</sub>	Set-Up Time, D or RC Inputs (see definitions)	t <sub>r</sub> = t <sub>f</sub> = 10ns	0°C to 70°C		120	ns
			-55°C to 125°C		120	
t <sub>h</sub>	Hold Time, D or RC Inputs (see definitions)	t <sub>r</sub> = t <sub>f</sub> = 10ns	0°C to 70°C		40	ns
			-55°C to 125°C		60	
t <sub>pd</sub>	Delay, Clock to Output LOW or HIGH	R <sub>L</sub> = 4k, C <sub>L</sub> = 10pF	0°C to 70°C	(Note 3)	200	ns
			-55°C to 125°C		280	
C <sub>in</sub>	Capacitance, Data Clock and RC Inputs (Note 2)	f = 1MHz, V <sub>IN</sub> = V <sub>SS</sub>		3.0	7.0	pF
C <sub>o</sub>	Capacitance, Clock Input (Note 2)	f = 1MHz, V <sub>IN</sub> = V <sub>SS</sub>		3.0	7.0	pF

Notes: 2. This parameter is periodically sampled but not 100% tested. It is guaranteed by design.

3. At any temperature, t<sub>pd</sub> min. is always much greater than t<sub>h</sub>(D) max.

8077984 0000116 43T

14

### TIMING DIAGRAM

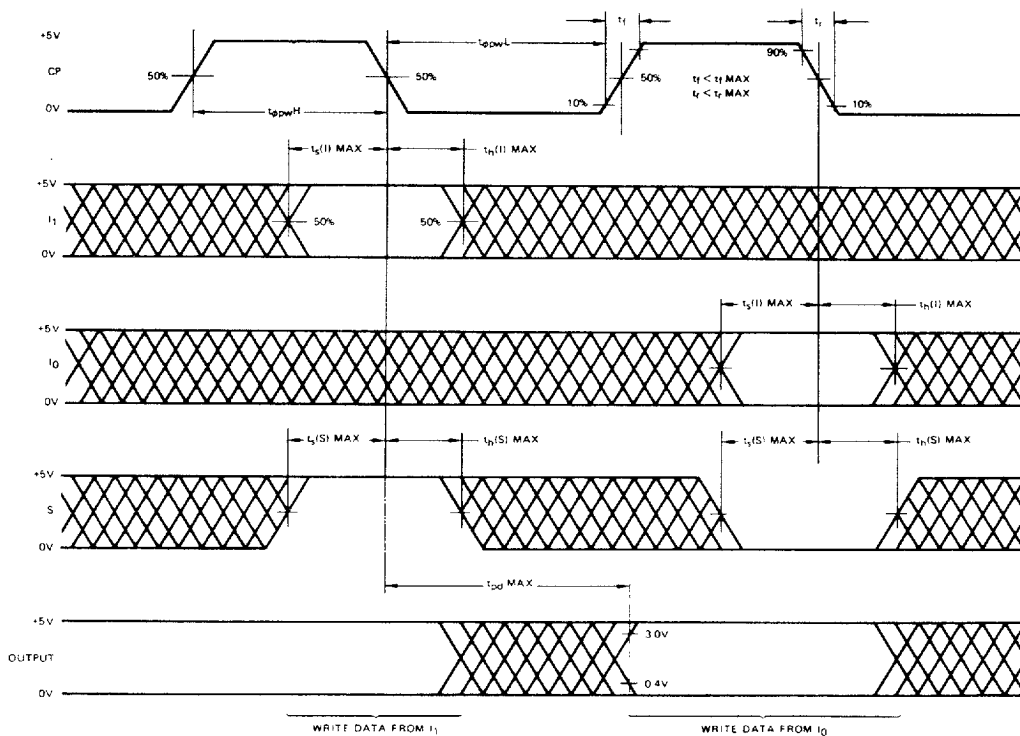

### TYPICAL PERFORMANCE CURVES

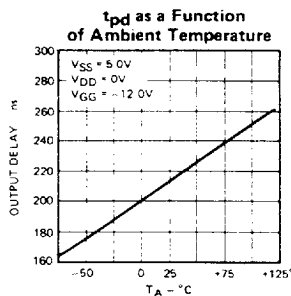
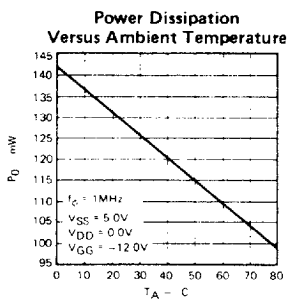

### DEFINITION OF TERMS

**STATIC SHIFT REGISTER** A shift register that is capable of maintaining stored data without being continuously clocked. Most static shift registers are constructed with dynamic master and static slave flip-flops. The data is stored dynamically while the clock is HIGH and is transferred to the static slaves while the clock is LOW. The clock may be stopped indefinitely in the LOW state, but there are limitations on the time it may reside in the HIGH state.

**SET-UP and HOLD TIMES** The shift register will accept the data that is present on its input around the time the clock goes from HIGH-to-LOW. Because of variations in individual devices, there is some uncertainty as to exactly when, relative to this clock transition, the data will be stored. The set-up and hold times define the limits on this uncertainty. To guarantee storing the correct data, the data inputs should not be changed between the maximum set-up time before the clock transition and the maximum hold time after the clock transition. Data changes within this interval may or may not be detected.

8077984 0000117 376

15

## APPLICATIONS

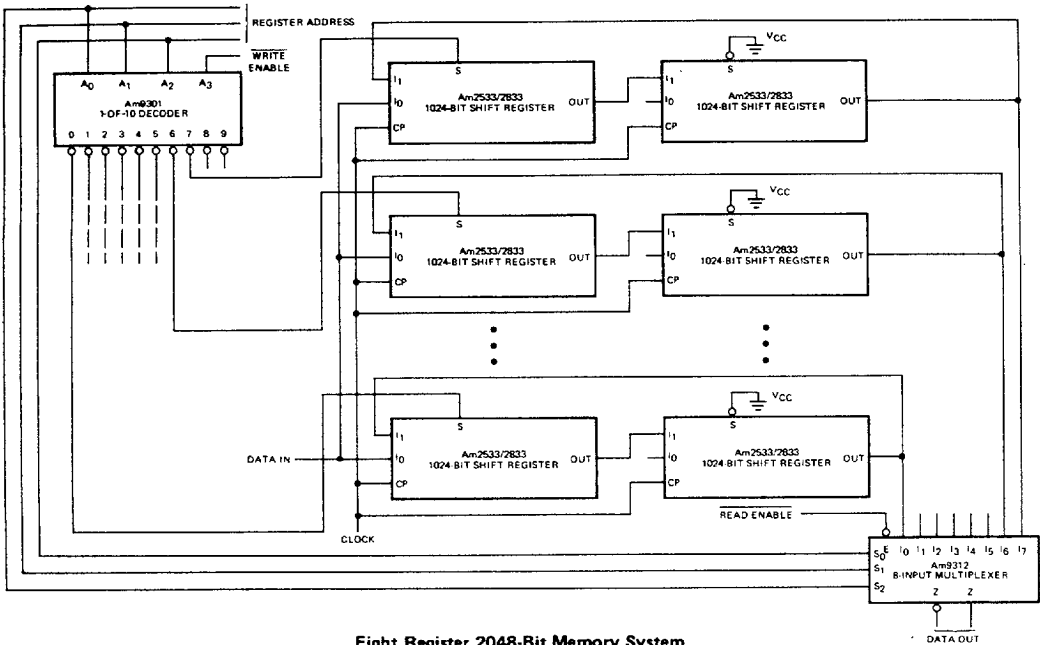

**Eight Register 2048-Bit Memory System**

Data enters one of the eight 2048-bit registers when the write enable input to the decoder is LOW. The addressed register will accept the data on the data input; the other seven registers will recirculate their data. Outputs are driven directly into an Am9312 8-input multiplexer. Obviously, the read and write registers need not be the same.

### PHYSICAL DIMENSIONS Molded 8-Pin DIP

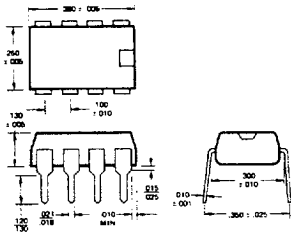

### TRUTH TABLE

S	I <sub>0</sub>	I <sub>1</sub>	Data Entered
L	L	X	L
L	H	X	H
H	X	L	L
H	X	H	H

H = HIGH Voltage level  
L = LOW Voltage Level  
X = Don't Care

### Hermetic 8-Pin DIP

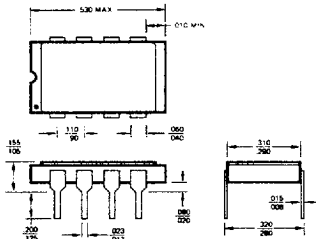

### Metalization and Pad Layout

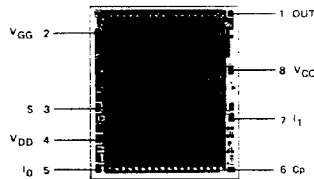

DIE SIZE: 0.133" X 0.163"

■ 8077984 0000118 202 ■