

Jun 13, 2001

Ver. 3.1

16/32 BIT RISC/DSP

GMS30C2116

GMS30C2132

USER'S MANUAL



Revision 3.1

**Published by
IDA Team in Hynix Semiconductor Inc.**

© Hynix Semiconductor 2001. All Right Reserved.

Hynix Offices in Korea or Distributors and Representatives listed at address directory may serve additional information of this manual.

Hynix reserves the right to make changes to any Information here in at any time without notice.

The information, diagrams, and other data in this manual are correct and reliable; however, Hynix is in no way responsible for any violations of patents or other rights of the third party generated by the use of this manual.

Specifications and information in this document are subject to change without notice and do not represent a commitment on the part of Hynix. Hynix reserves the right to make changes to improve functioning. Although the information in this document has been carefully reviewed, Hynix does not assume any liability arising out of the use of the product or circuit described herein.

Hynix does not authorize the use of the Hynix microprocessor in life support applications wherein a failure or malfunction of the microprocessor may directly threaten life or cause injury. The user of the Hynix microprocessor in life support applications assumes all risks of such use and indemnifies Hynix against all damages.

For further information please contact:



SEOUL OFFICE : Hynix Semiconductor YOUNG DONG Bldg.

891, Daechi-dong, Kangnam-gu,
Seoul, Korea.

PHONE : (02) 3459-3662~3

FAX : (02) 3459-3942

SYSTEM IC : 1, Hyangjeong-dong, Hungduk-gu,

Cheongju, 361-725, Korea.

PHONE : (0431) 270-4030~47

FAX : (0431) 270-4075

Table of Contents

0. Overview

0.1 GMS30C2116/32 RISC/DSP.....	0-1
0.2 Block Diagram.....	0-6
0.3 Pin Configuration.....	0-7
0.3.1 GMS30C2132, 160-Pin MQFP-Package - View from Top Side	0-7
0.3.2 Pin Cross Reference by Pin Name	0-8
0.3.3 Pin Fuction	0-9

1. Architecture

1.1 Introduction.....	1-1
1.1.1 RISC Architecture	1-1
1.1.2 Techniques to reduce CPI (Cycles per Instruction).....	1-2
1.1.3 The pipeline structure of GMS30C2132	1-6
1.2 Global Register Set	1-7
1.2.1 Program Counter PC, G0	1-8
1.2.2 Status Register SR, G1	1-9
1.2.3 Floating-Point Exception Register FER, G2	1-12
1.2.4 Stack Pointer SP, G18	1-13
1.2.5 Upper Stack Bound UB, G19	1-13
1.2.6 Bus Control Register BCR, G20	1-13
1.2.7 Timer Prescaler Register TPR, G21	1-14
1.2.8 Timer Compare Register TCR, G22.....	1-14
1.2.9 Timer Register TR, G23	1-14
1.2.10 Watchdog Compare Register WCR, G24.....	1-14
1.2.11 Input Status Register ISR, G25	1-14
1.2.12 Function Control Register FCR, G26.....	1-14
1.2.13 Memory Control Register MCR, G27	1-15
1.3 Local Register Set.....	1-15
1.4 Privilege States	1-16
1.5 Register Data Types.....	1-17
1.6 Memory Organization.....	1-18
1.7 Stack.....	1-20
1.8 Instruction Cache	1-25
1.9 On-Chip Memory (IRAM).....	1-28

2. Instructions General

2.1	Instruction Notation.....	2-1
2.2	Instruction Execution.....	2-2
2.3	Instruction Formats.....	2-3
2.3.1	Table of Immediate Values.....	2-5
2.3.2	Table of Instruction Codes.....	2-6
2.3.3	Table of Extended DSP Instruction Codes.....	2-7
2.4	Entry Tables.....	2-8
2.5	Instruction Timing.....	2-12

3. Instruction Set

3.1	Memory Instructions.....	3-1
3.1.1	Address Modes.....	3-2
3.1.2	Load Instructions.....	3-7
3.1.3	Store Instructions.....	3-9
3.2	Move Word Instructions.....	3-11
3.3	Move Double-Word Instruction.....	3-11
3.4	Logical Instructions.....	3-12
3.5	Invert Instruction.....	3-13
3.6	Mask Instruction.....	3-13
3.7	Add Instructions.....	3-14
3.8	Sum Instructions.....	3-16
3.9	Subtract Instructions.....	3-17
3.10	Negate Instructions.....	3-18
3.11	Multiply Word Instruction.....	3-19
3.12	Multiply Double-Word Instructions.....	3-19
3.13	Divide Instructions.....	3-20
3.14	Shift Left Instructions.....	3-22
3.15	Shift Right Instructions.....	3-23
3.16	Rotate Left Instruction.....	3-24
3.17	Index Move Instructions.....	3-25
3.18	Check Instructions.....	3-26
3.19	No Operation Instruction.....	3-26
3.20	Compare Instructions.....	3-27
3.21	Compare Bit Instructions.....	3-27
3.22	Test Leading Zeros Instruction.....	3-28
3.23	Set Stack Address Instruction.....	3-28
3.24	Set Conditional Instructions.....	3-28
3.25	Branch Instructions.....	3-30
3.26	Delayed Branch Instructions.....	3-31

3.27	Call Instruction	3-33
3.28	Trap Instructions	3-34
3.29	Frame Instruction	3-35
3.30	Return Instruction	3-37
3.31	Fetch Instruction	3-38
3.32	Extended DSP Instructions	3-39
3.33	Software Instructions	3-41
3.33.1	Do Instruction.....	3-42
3.33.2	Floating-Point Instructions	3-43

4. Exceptions

4.1	Exception Processing	4-1
4.2	Exception Types	4-2
4.2.1	Reset	4-2
4.2.2	Range, Pointer, Frame and Privilege Error	4-2
4.2.3	Extended Overflow.....	4-2
4.2.4	Parity Error	4-3
4.2.5	Interrupt	4-3
4.2.6	Trace Exception.....	4-3
4.3	Exception Backtracking	4-4

5. Timer

5.1	Overview.....	5-1
5.1.1	Timer Prescaler Register TPR.....	5-1
5.1.2	Timer Register TR.....	5-2
5.1.3	Timer Compare Register TCR	5-2

6. Bus Interface

6.1	Bus Control General	6-1
6.1.1	SRAM and ROM Bus Access	6-1
6.1.1.1	SRAM and ROM Single-Cycle Read Access	6-2
6.1.1.2	SRAM and ROM Multi-Cycle Read Access	6-2
6.1.1.3	SRAM Single-Cycle Write Access	6-3
6.1.1.4	SRAM Multi-Cycle write Access	6-3
6.1.2	DRAM Bus Access	6-4
6.1.2.1	DRAM Access	6-5
6.1.2.2	DRAM Refresh (CAS before RAS Refresh)	6-6
6.1.3	I/O Bus Access	6-7
6.1.3.1	I/O Read Access	6-7
6.1.3.2	I/O Write Access	6-8

6.2	I/O Bus Control	6-9
6.3	Bus Control Register BCR	6-10
6.4	Memory Control Register MCR	6-13
6.4.1	Output Voltage	6-14
6.4.2	Input Threshold	6-14
6.4.3	Power Down.....	6-14
6.4.4	IRAM Refresh Test.....	6-15
6.4.5	IRAM Refresh Rate	6-15
6.4.6	Entry Table Map	6-15
6.4.7	MEMx Bus Hold Break	6-15
6.5	Input Status Register ISR	6-16
6.6	Function Control Register FCR.....	6-17
6.7	Watchdog Compare Register WCR.....	6-19
6.8	IO3 Control Modes.....	6-19
6.8.1	IO3Standard Mode	6-19
6.8.2	Watchdog Mode	6-19
6.8.3	IO3Timing Mode	6-20
6.8.4	IO3TimerInterrupt Mode	6-20
6.9	Bus Signals	6-21
6.9.1	Bus Signals for the GMS30C2132 Processor	6-21
6.9.2	Bus Signals for the GMS30C2116 Processor	6-22
6.9.3	Bus Signal Description.....	6-23
6.10	DC Characteristics.....	6-27
6.11	AC Characteristics.....	6-29
6.11.1	Processor Clock.....	6-29
6.11.2	DRAM RAS Access.....	6-30
6.11.3	DRAM Fast Page Mode Access.....	6-31
6.11.3.1	Multi-Cycle Access.....	6-31
6.11.3.2	Single-Cycle Access	6-32
6.11.4	DRAM CAS-Before-RAS Refresh	6-34
6.11.5	SRAM Access	6-35
6.11.5.1	Multi-Cycle Access.....	6-35
6.11.5.2	Single-Cycle Access	6-37
6.11.6	I/O Access	6-38

7. Mechanical Data

7.1	GMS30C2132, 160-Pin MQFP-Package	7-1
7.1.1	Pin Configuration - View from Top Side	7-1
7.1.2	Pin Cross Reference by Pin Name	7-2
7.1.3	Pin Cross Reference by Location	7-3
7.2	GMS30C2132, 144-Pin TQFP-Package	7-4
7.2.1	Pin Configuration - View from Top Side	7-4
7.2.2	Pin Cross Reference by Pin Name	7-5
7.2.3	Pin Cross Reference by Location	7-6
7.3	GMS30C2116, 100-Pin TQFP-Package	7-7
7.3.1	Pin Configuration - View from Top Side	7-7
7.3.2	Pin Cross Reference by Pin Name	7-8
7.3.3	Pin Cross Reference by Location	7-9
7.4	Package-Dimensions	7-10

Appendix. Instruction Set Details

0. Overview

0.1 GMS30C2116/32 RISC/DSP

The GMS30C2116 and GMS30C2132 RISC/DSP present a new class of microprocessors: The combination of a high-performance *RISC* microprocessor with an additional powerful *DSP instruction set* and *on-chip micro-controller functions*. The high throughput is not achieved by raw clock speed, it is due to a sophisticated novel architecture, combining the advantages of RISC and DSP technology.

The speed is obtained by an optimized combination of the following features:

- ı ü The most recent stack frames are kept in a register stack, thereby reducing data memory accesses to a minimum by keeping almost all local data in registers.
- ı ü *Pipelined memory access* allows overlapping of memory accesses with execution.
- ı ü *4KByte on-chip memory*.
- ı ü *On-chip instruction cache* omits instruction fetch in inner loops and provides pre-fetch.
- ı ü *Variable-length instructions* of 16, 32 or 48 bits provide a large, powerful instruction set, thereby reducing the number of instructions to be executed.
- ı ü Primarily used 16-bit instructions halve the memory bandwidth required for instruction fetch in comparison to conventional RISC architectures with fixed-length 32-bit instructions, yielding also even better code economy than conventional CISC architectures.
- ı ü Regular instruction set allows hardwiring of control logic at low component count.
- ı ü *Most instructions execute in one cycle*.
- ı ü *Pipelined DSP instructions*.
- ı ü Parallel execution of ALU and DSP instructions.
- ı ü Single-cycle half word multiply-accumulate operation.
- ı ü *Fast Call and Return* by parameter passing via registers.
- ı ü *An instruction pipeline depth of only two stages* - decode/execute - provides branching without insertion of wait cycles in combination with Delayed Branch instructions.
- ı ü Range and pointer checks are performed without speed penalty, thus, these checks need no longer be turned off, thereby providing higher runtime reliability.
- ı ü *Separate address and data buses* provide a throughput of one 32-bit word each cycle.

The features noted above contribute to reduce the number of idle wait cycles to a bare minimum. The processor is designed to sustain its execution rate with a standard DRAM memory.

The low power consumption is of advantage for mobile (portable) applications or in temperature-sensitive environments.

In the current version, the GMS30C2116 and GMS30C2132 RISC/DSP are implemented in a 0.6 μm -CMOS-process.

The GMS30C2116 and GMS30C2132 RISC/DSP are based on *hyperstone* architecture.

0.1. GMS30C2116/32 RISC/DSP (continued)

Most of the transistors are used for the on-chip memory, the instruction cache, the register stack and the multiplier, whereas only a small-number is required for the control logic.

Due to the Hynix's low system cost, the GMS30C2116 and GMS30C2132 RISC/DSP are very well suited for embedded-systems applications requiring high performance and lowest cost. To simplify board design as well as to reduce system costs, the GMS30C2116 and GMS30C2132 already come with integrated periphery, such as a timer and memory and bus control logic. Therefore, complete systems with the Hynix's microprocessor can be implemented with a minimum of external components. To connect any kind of memory or I/O, no glue logic is necessary. It is even suitable for systems where up to now microprocessors with 16-bit architecture have been used for cost reasons. Its improved performance compared to conventional micro-controllers can be used to software-substitute many external peripherals like graphics controllers or DSPs.

The software development tools include an optimizing C compiler, assembler, source-level debugger with profiler as well as a real-time kernel with an extremely fast response time. Using this real-time kernel, up to 31 tasks, each with its own virtual timer, can be developed independently of each other. The synchronization of these tasks is effected almost automatically by the real-time kernel. To the developer, it seems as if he has up to 31 Hynix's microprocessors to which he can allocate his programs accordingly. Real-time debugging of multiple tasks is assisted in an optimized way.

The following description gives a brief architectural overview:

Registers:

- 32 global and 64 local registers of 32 bits each
- 16 global and up to 16 local registers are addressable directly

Flags:

- Zero(Z), negative(N), carry(C) and overflow(V) flag
- Interrupt-mode, interrupt-lock, trace-mode, trace-pending, supervisor state, cache-mode and high global flag

Register Data Types:

- Unsigned integer, signed integer, signed short, signed complex short, 16-bit fixed-point, bit-string, IEEE-754 floating-point, each either 32 or 64 bits

External Memory:

- Address space of 4Gbytes, divided into five areas
- Separate I/O address space
- Load/Store architecture
- Pipelined memory and I/O accesses
- High-order data located and addressed at lower address (big endian)
- Instructions and double-word data may cross DRAM page boundaries

0.1. GMS30C2116/32 RISC/DSP (continued)

On-chip Memory:

- 4KByte internal (on-chip) memory

Memory Data Types:

- Unsigned and signed byte (8 bit)
- Unsigned and signed half word (16 bit), located on half word boundary
- Undedicated word (32 bit), located on word boundary
- Undedicated double-word (64 bit), located on word boundary

Runtime Stack:

- Runtime stack is divided into memory part and register part
- Register part is implemented by the 64 local registers holding the most recent stack frame(s)
- Current stack frame (maximum 16 registers) is always kept in register part of the stack
- Data transfer between memory and register part of the stack is automatic
- Upper stack bound is guarded

Instruction Cache:

- An on-chip instruction cache reduces instruction memory access substantially

Instructions General:

- Variable-length instructions of one, two or three half words halve required memory bandwidth
- Pipeline depth of only two stages, assures immediate refill after branches
- Register instructions of type "source operator destination \Rightarrow destination" or "source operator immediate \Rightarrow destination"
- All register bits participate in an operation
- Immediate operands of 5, 16 and 32 bits, zero- or sign-expanded
- Large address displacement of up to 28 bits
- Two sets of signed arithmetical instructions: instructions set or clear either only the overflow flag or trap additionally to a Range Error routine on overflow
- DSP instructions operate on 16-bit integer, real and complex fixed-point data and 32-bit integer data into 32-bit and 64-bit hardware accumulators

Instruction Summary:

- Memory instructions pipelined to a depth of two stages, trap on address register equal to zero (check for invalid pointers)

0.1. GMS30C2116/32 RISC/DSP (continued)

- i ü Memory address modes: register address, register post-increment, register + displacement (including PC relative), register post-increment by displacement (next address), absolute, stack address, I/O absolute and I/O displacement
- i ü Load, all data types, bytes and half words right adjusted and zero- or sign-expanded, execution proceeds after Load until data is needed
- i ü Store, all data types, trap when range of signed byte or half word is exceeded
- i ü Move, Move immediate, Move double-word
- i ü Logical instructions AND, AND not, OR, XOR, NOT, AND not immediate, OR immediate, XOR immediate
- i ü Mask source and immediate \Rightarrow destination
- i ü Add unsigned/signed, Add signed with trap on overflow, Add with carry
- i ü Add unsigned/signed immediate, Add signed immediate with trap on overflow
- i ü Sum source + immediate \Rightarrow destination, unsigned/signed and signed with trap on overflow
- i ü Subtract unsigned/signed, Subtract signed with trap on overflow, Subtract with carry
- i ü Negate unsigned/signed, Negate signed with trap on overflow
- i ü Multiply word * word \Rightarrow low-order word unsigned or signed, Multiply word * word \Rightarrow double-word unsigned and signed
- i ü Divide double-word by word \Rightarrow quotient and remainder, unsigned and signed
- i ü Shift left unsigned/signed, single and double-word, by constant and by content of register, Shift left signed by constant with trap on loss of high-order bits
- i ü Shift right unsigned and signed, single and double-word, by constant and by content of register
- i ü Rotate left single word by content of register
- i ü Index Move, move an index value scaled by 1, 2, 4 or 8, optionally with bounds check
- i ü Check a value for an upper bound specified in a register or check for zero
- i ü Compare unsigned/signed, Compare unsigned/signed immediate
- i ü Compare bits, Compare bits immediate, Compare any byte zero
- i ü Test number of leading zeros
- i ü Set Conditional, save conditions in a register
- i ü Branch unconditional and conditional (12 conditions)
- i ü Delayed Branch unconditional and conditional (12 conditions)
- i ü Call subprogram, unconditional and on overflow
- i ü Trap to supervisor subprogram, unconditional and conditional (11 conditions)
- i ü Frame, structure a new stack frame, include parameters in frame addressing, set frame length, restore reserve frame length and check for upper stack bound
- i ü Return from subprogram, restore program counter, status register and return-frame

0.1. GMS30C2116/32 RISC/DSP (continued)

- i ü Software instructions, call an associated subprogram and pass a source operand and the address of a destination operand to it
- i ü DSP Multiply instructions:
signed and/or unsigned multiplication \Rightarrow single and double word product
- i ü DSP Multiply-Accumulate instructions:
signed multiply-add and multiply-subtract \Rightarrow single and double word product sum and difference
- i ü DSP Half word Multiply-Accumulate instructions:
signed multiply-add operating on four half word operands \Rightarrow single and double word product sum
- i ü DSP Complex Half word Multiply instruction:
signed complex half word multiplication \Rightarrow real and imaginary single word product
- i ü DSP Complex Half word Multiply-Accumulate instruction:
signed complex half word multiply-add \Rightarrow real and imaginary single word product sum
- i ü DSP Add and Subtract instructions:
signed half word add and subtract with and without fixed-point adjustment \Rightarrow single word sum and difference
- i ü Floating-point instructions are architecturally fully integrated, they are executed as Software instructions by the present version. Floating-point Add, Subtract, Multiply, Divide, Compare and Compare unordered for single and double-precision, and Convert single \Leftrightarrow double are provided.

Exceptions:

- i ü Pointer, Privilege, Frame and Range Error, Extended Overflow, Parity Error, Interrupt and Trace mode exception
- i ü Watchdog function
- i ü Error-causing instructions can be identified by backtracking, thus allowing a very detailed error analysis

Timer:

- i ü Two multifunctional timers

Bus Interface:

- i ü Separate address bus of 26 (GMS30C2132) or 22 (GMS30C2116) bits and data bus of up to 32 (GMS30C2132) or 16 bits (GMS30C2116) provide a throughput of four or two bytes at each clock cycle
- i ü Data bus width of 32, 16 or 8 bits, individually selectable for each external memory area.
- i ü Up to seven vectored interrupts
- i ü Configurable I/O pins
- i ü Internal generation of all memory and I/O control signals

0.2 Block Diagram

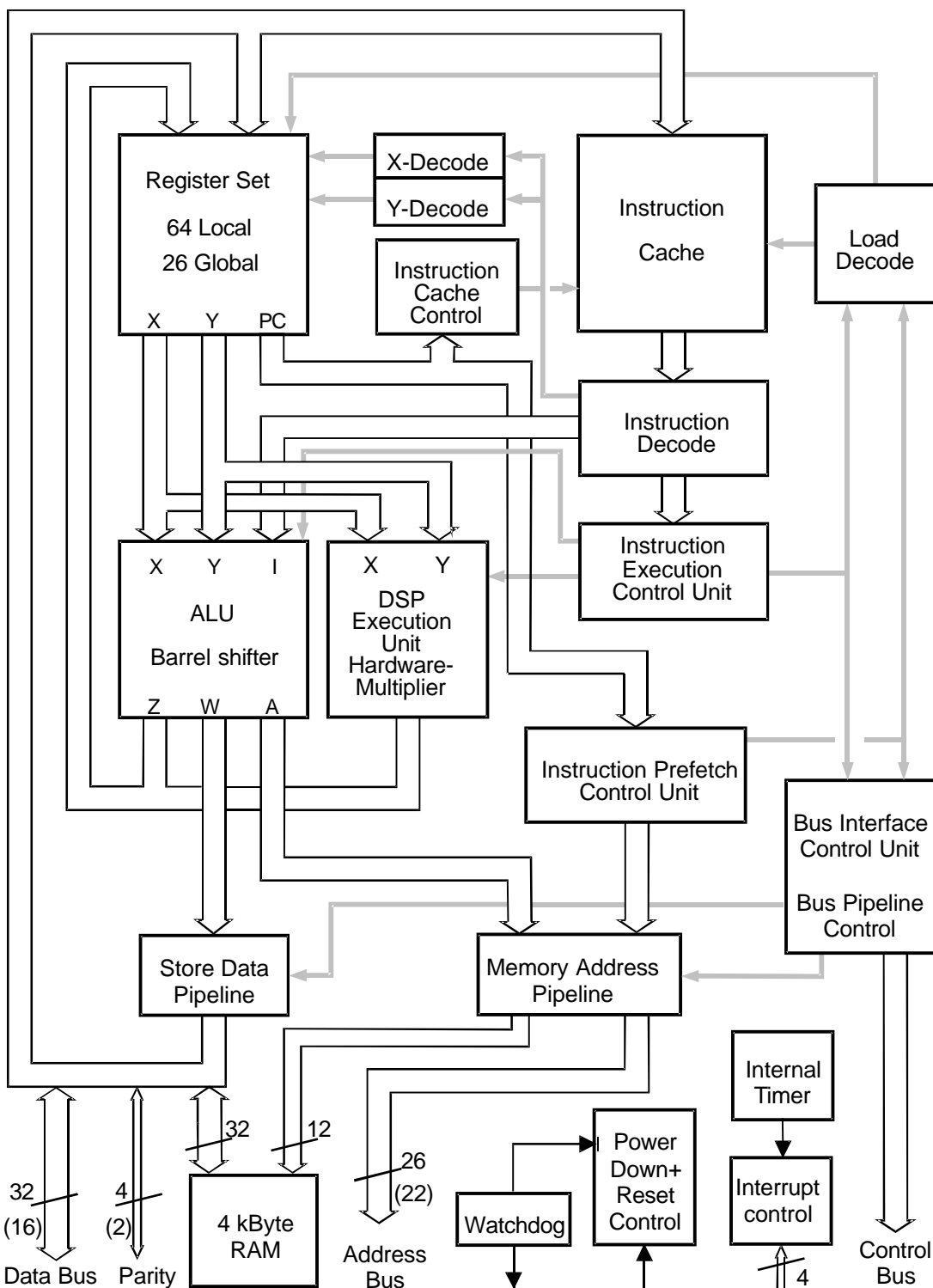

Figure 0.1: Block Diagram

0.3 Pin Configuration

0.3.1 GMS30C2132, 160-Pin MQFP-Package - View from Top Side

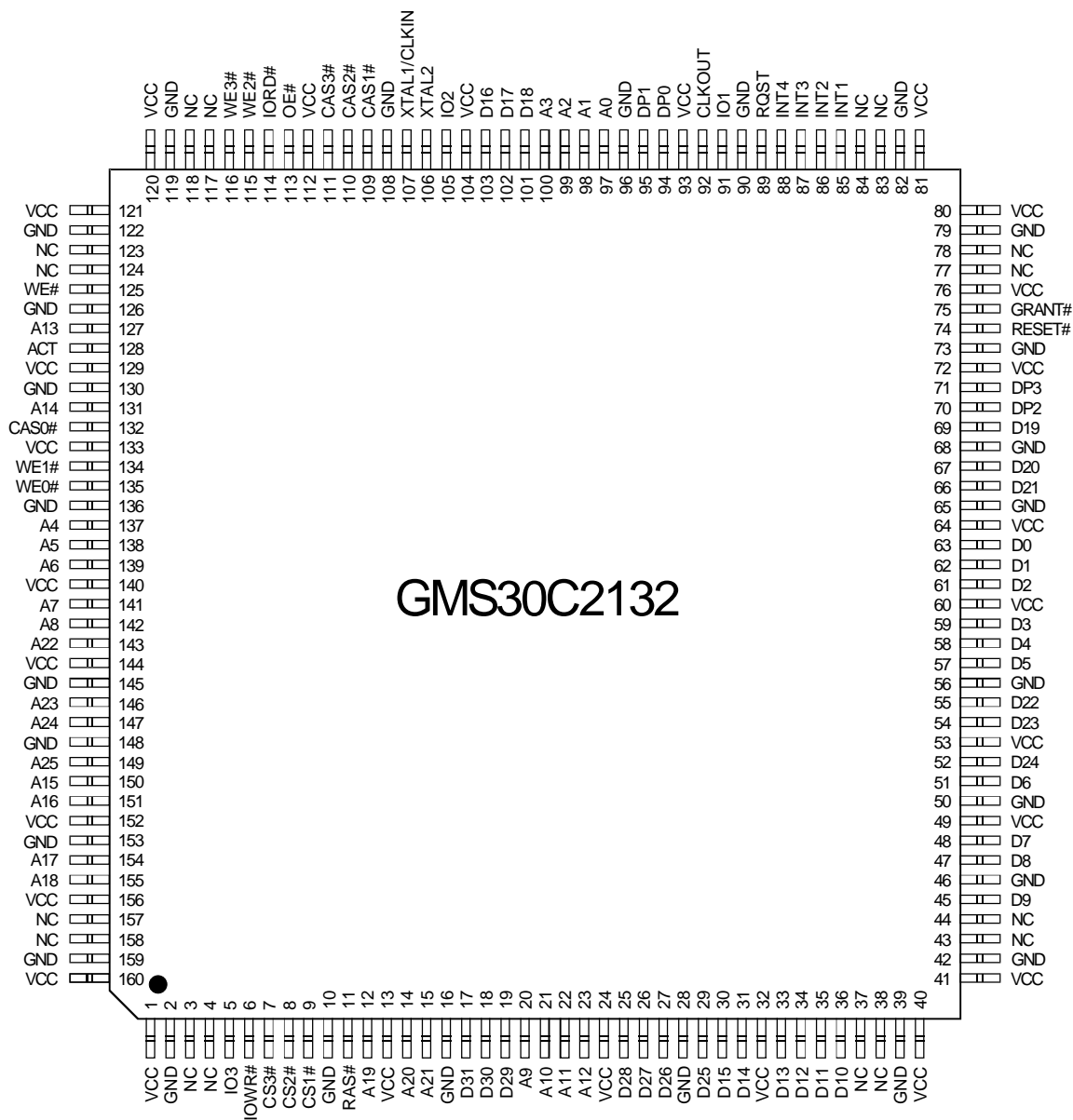

Figure 0.2: GMS30C2132, 160-Pin MQFP-Package

0.3. Pin Configuration (continued)

0.3.2 Pin Cross Reference by Pin Name

Signal	Location	Signal	Location	Signal	Location	Signal	Location
A0	97	D5	57	GND	65	NC	124
A1	98	D6	51	GND	68	NC	157
A2	99	D7	48	GND	73	NC	158
A3	100	D8	47	GND	79	OE#	113
A4	137	D9	45	GND	82	RAS#	11
A5	138	D10	36	GND	90	RESET#	74
A6	139	D11	35	GND	96	RQST	89
A7	141	D12	34	GND	108	VCC	1
A8	142	D13	33	GND	119	VCC	13
A9	20	D14	31	GND	122	VCC	24
A10	21	D15	30	GND	126	VCC	32
A11	22	D16	103	GND	130	VCC	40
A12	23	D17	102	GND	136	VCC	41
A13	127	D18	101	GND	145	VCC	49
A14	131	D19	69	GND	148	VCC	53
A15	150	D20	67	GND	153	VCC	60
A16	151	D21	66	GND	159	VCC	64
A17	154	D22	55	GRANT#	75	VCC	72
A18	155	D23	54	INT1	85	VCC	76
A19	12	D24	52	INT2	86	VCC	80
A20	14	D25	29	INT3	87	VCC	81
A21	15	D26	27	INT4	88	VCC	93
A22	143	D27	26	IO1	91	VCC	104
A23	146	D28	25	IO2	105	VCC	112
A24	147	D29	19	IO3	5	VCC	120
A25	149	D30	18	IORD#	114	VCC	121
ACT	128	D31	17	IOWR#	6	VCC	133
CAS0#	132	DP0	94	NC	3	VCC	140
CAS1#	109	DP1	95	NC	4	VCC	156
CAS2#	110	DP2	70	NC	37	VCC	160
CAS3#	111	DP3	71	NC	38	VCC	129
CLKOUT	92	GND	2	NC	43	VCC	144
CS1#	9	GND	10	NC	44	VCC	152
CS2#	8	GND	16	NC	77	WE#	125
CS3#	7	GND	28	NC	78	WE0#	135
D0	63	GND	39	NC	83	WE1#	134
D1	62	GND	42	NC	84	WE2#	115
D2	61	GND	46	NC	117	WE3#	116
D3	59	GND	50	NC	118	XTAL1/CLKIN	107
D4	58	GND	56	NC	123	XTAL2	106

0.3. Pin Configuration (continued)

0.3.3 Pin Function

Type	Name	State	Use
Power	VCC	I	Power. Connected to the power supply. It can be selected 5.0V or 3.3V power supply.
	GND	I	Ground. Connected to the system ground. All GND pins must be connected to the system ground.
Clock	XTAL1	I	Input for Quartz Clock. When external clock generator generates the clock, XTAL1 is used as clock input.
	XTAL2	O	Output for Quartz Clock.
	CLKOUT	O	Clock Signal Output. It can be used to supply a clock signal to peripheral devices.
Address Bus	A25..A0	O/Z	Address Bus. With the GMS30C2132, only A22..A0 are connected to the address bus pins
Data Bus	D31..D0	I/O	Data Bus. 32-bit bi-directional data bus
	DP0..DP3	I/O	Data Parity Signal. Bi-directional parity signals
Bus Control	RAS#	O/Z	Row Address Strobe. RAS# is activated when the processor accesses a DRAM or refresh cycle. When a SRAM is placed in MEM0, RAS# is used as the chip select signal
	CAS0#..CAS3#	O/Z	Column Address Strobe. They are only used by a DRAM for column access cycles and for “CAS before RAS” refresh.
	WE#	O/Z	Write Enable. Active low indicates a write access, active high indicates a read access.
	CS1#..CS3#	O/Z	Chip Select. Active low of CS1#..CS3# indicates chip select for the memory areas MEM1..MEM3.
	WE0#..WE3#	O/Z	SRAM Write Enable. Active low indicates write enable for the corresponding byte.
	OE#	O/Z	Output Enable for SRAM's and EPROM's.
	IORD#	O/Z	I/O Read Strobe, optionally I/O Data Strobe. The use of IORD# is specified in the I/O address bit 10.
	IOWR#	O/Z	I/O Write Strobe.

0.3. Pin Configuration (continued)

Type	Name	State	Use
Bus Control	RQST	O	RQST signals the request for a memory or I/O access
	GRANT#	I	Bus Grant. GRANT# is signaled low by an bus arbiter to grant access to the bus for memory and I/O cycles
	ACT	O	Active as bus master. ACT is signaled high when GRANT# is low and it is kept high during a current bus access
Interrupt	INT1..INT4	I	Interrupt Request A signal of INT1..INT4 interrupt request pins causes an interrupt exception when interrupt lock flag L is clear and the corresponding INTxMask bit in FCR is not set.
I/O Port	IO1..IO3	I/O	General Input-Output Port. IO1..IO3 can be individually configured via IOxDirection bits in the FCR as either input or output pins (port).
System Control	RESET#	I	Reset Processor. RESET# low resets the processor to the initial state and halts all activity. RESET# must be low for at least two cycles

1. Architecture

1.1 Introduction

1.1.1 RISC Architecture

In the early days of computer history, most computer families started with an instruction set which was rather simple. The main reason for being simple then was the high cost for hardware. The hardware cost has dropped and the software cost has gone up steadily in the past three decades.

The net result is that more and more functions have been built into the hardware, making the instruction set very large and very complex. The growth of instruction sets was also encouraged by the popularity of microprogrammed control in the 1960s and 1970s. Even user-defined instruction sets were implemented using microcodes in some processors for special-purpose applications.

The evolution of computer architectures has been dominated by families of increasingly complex processors. Under market pressures to preserve existing software, *Complex Instruction Set Computer (CISC)* architectures evolved by the gradual addition of microcode and increasingly elaborate operations. The intent was to supply more support for high-level languages and operating systems, as semiconductor advances made it possible to fabricate more complex integrated circuits. It seemed self-evident that architectures should become more complex as these technological advances made it possible to hold more complexity on VLSI devices.

In recent years, however, *Reduced Instruction Set Computer (RISC)* architectures have implemented a much more sophisticated handling of the complex interaction between hardware, firmware and software. RISC concepts emerged from statistical analysis of how software actually uses the resources of a processor. Dynamic measurement of system kernels and object modules generated by optimizing compilers show an overwhelming predominance of the simplest instruction, even in the code for CISC machine. Complex instructions are often ignored because a single way of performing a complex operation needs of high-level language and system environments. RISC designs eliminate the microcoded routines and turn the low-level control of the machine over to software.

This approach is not new. But its application is more universal in recent years thanks to the prevalence of high-level languages, the development of compilers that can optimize at the microcode level, and dramatic advances in semiconductor memory and packaging. It is now feasible to replace machine microcode ROM with faster RAM, organized as an instruction cache. Machine control then resides in the instruction cache and is, in fact, customized on the fly. The instruction stream generated by system- and compiler-generated code provides a precise fit between the requirements of high-level software and the capabilities of the hardware. So compilers are playing a vital role in RISC performance.

The advantage of RISC architecture is described as follows:

- Simplicity made VLSI implementation possible and thus higher clock rates.
- Hardwired control and separated data and program caches lower the average CPI (Cycles per Instruction) significantly.
- Dynamic instruction count in a RISC program only increased slightly (less than 2) in ordinary program.

- Recently, the MIPS (Million Instructions per Second) rate of a typical RISC microprocessor increased with a factor of $5/(2*0.1) = 25$ times from that of a typical CISC microprocessor.
- The clock rate increased from 10 MHz on a CISC processor to 50 MHz on a CMOS/RISC microprocessor.
- The instruction count in a typical RISC program increased less than 2 times from that of a typical CISC program.
- The average CPI for a RISC microprocessor decreased to 1.2 (instead of 12 as in a typical CISC processor).

1.1.2 Techniques to reduce CPI (Cycles per Instruction)

If the work each instruction performs is simple and straightforward, the time required to execute each instruction can be shortened and the number of cycles reduced. The goal of RISC designs has been to achieve an execution rate of one instruction per machine cycle (multiple-instruction-issue designs now seek to increase this rate to more than one instruction per cycle). Techniques that help achieve this goal include:

- Instruction pipelines
- Load and store (load/store) architecture
- Delayed load instructions
- Delayed branch instructions

(1) Instruction Pipelines

One way to reduce the number of cycles required to execute an instruction is to overlap the execution of multiple instructions. Instruction pipelines divide the execution of each instruction into several discrete portions and then execute multiple instructions simultaneously. The instruction pipeline technique can be likened to an assembled line - the instruction progresses from one specialized stage to the next until it is complete (or issued) - just as an automobile moves along an assembly line. (This is contrast to the nonpipeline, microcode approach, where all the work is done by one general unit and is less capable at each individual task.) For example, the execution of an instruction might be subdivided into four portions, or clock cycles, as shown in Figure 1.1:

Cycle #1	Cycle #2	Cycle #3	Cycle #1
Fetch Instruction (F)	ALU Operation (A)	Access Memory (M)	Write Results (W)

Figure 1.1: Functional Division of a Hypothetical Pipeline

An Instruction pipeline can potentially reduce the number of cycles/instructions by a factor equal to the depth of the pipeline (the depth of the pipeline = the number of resource). For example, in Figure 1.2 each instruction still requires a total of four clock cycles to execute. However, if a four-level instruction pipeline is used, a new instruction can be initiated at

each clock cycle and the effective execution rate is one cycle per instruction.

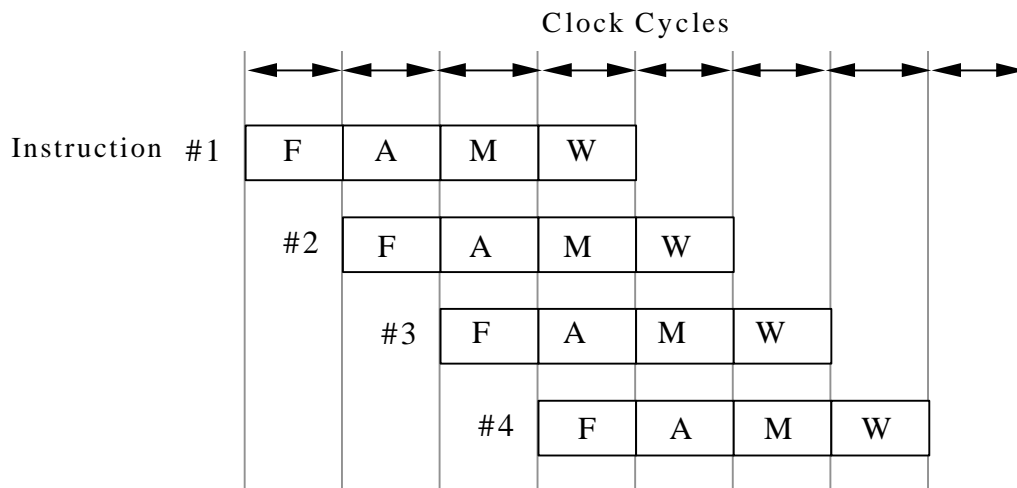

Figure 1.2: Multiple Instructions in a Hypothetical Pipeline

(2) Load/Store Architecture

The discussion of the instruction pipeline illustrates how each instruction can be subdivided into several discrete parts that permit the processor to execute multiple instructions in parallel. For this technique to work efficiently, the time required to execute each instruction subpart should be approximately equal. If one part requires an excessive length of time, there is an unpleasant choice: either halting the pipeline (inserting wait or idle cycles), or making all cycles longer to accommodate this lengthier portion of the instruction.

Instructions that perform operations on operands in memory tend to increase either the cycle time or the number of cycles/instruction. Such instruction require additional time for execution to calculate the addresses of the operands, read the required operands from memory, calculate the result, and store the results of the operation back to memory. To eliminate the negative impact of such instruction, RISC designs implement a load and store (load/store) architecture in which the processor has many register, all operations are performed on operands held in processor registers, and *main memory is accessed only by load and store instructions*.

This approach produces several benefits

- Reducing the number of memory accesses eases memory bandwidth requirements
- Limiting all operations to registers helps simplify the instruction set
- Eliminating memory operations makes it easier for compilers to optimize register allocation - this further reduces memory accesses and also reduces the instructions/task factor

All of these factors help RISC design approach their goal of executing one cycle/instruction. However, two classes of instructions hinder achievement of this goal - load instructions and branch instructions. The following sections discuss how RISC designs overcome obstacles raised by these classes of instructions.

(3) Delayed Load Instructions

Load instruction read operands from memory into processor register for subsequent operation by other instructions. Because memory typically operates at much slower speeds than processor clock rates, the loaded operand is not immediately available to subsequent instructions in an instruction pipeline. The data dependency is illustrated in Figure 1.3.

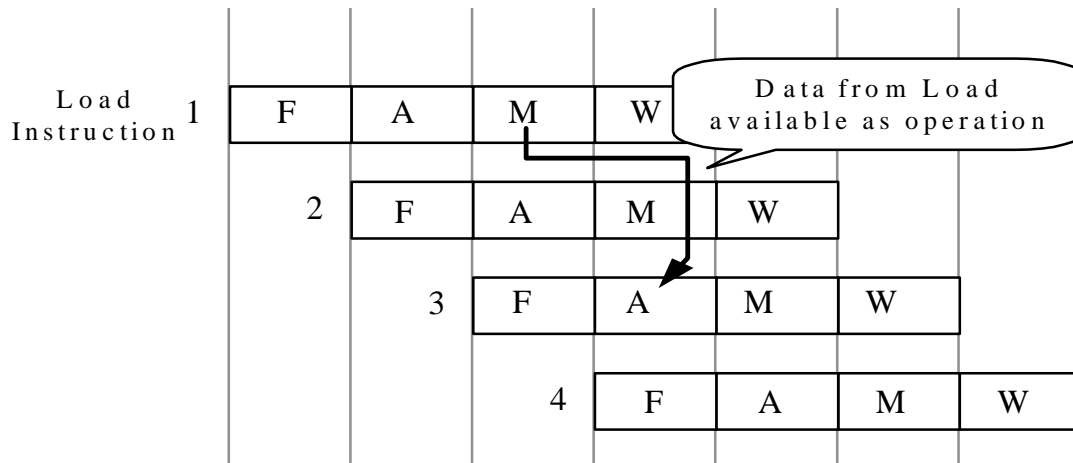

Figure 1.3: Data Dependency Resulting From a Load Instruction

In this illustration, the operand loaded by instruction 1 is not available for use in a cycle (ALU, or Arithmetic/Logic Unit operation) of instruction 2. One way to handle this dependency is to delay the pipeline by inserting additional clock cycles into the execution of instruction 2 until the loaded data becomes available. This approach obviously introduces delays that would increase the cycles/instructions factor.

In many RISC designs the technique used to handle this data dependency is to recognize and make visible to compilers the fact that all load instructions have an inherent latency or load delay. Figure 1.3 illustrates a load delay or latency of one instruction. The instruction that immediately follows the load is in the load delay slot. If the instruction in this slot does not require the data from the load, then no pipeline delay is required.

If this load delay is made visible to software, a compiler can arrange instructions to ensure that there is no data dependency a load instruction and the instruction in the load delay slot. The simplest way of ensuring that there is no data dependency is to insert a No Operation (NOP) instruction to fill the slot, as follow:

```

Load  R1, A
Load  R2, B
NOP   <= This instruction fills the delay slot
ADD   R3, R1, R2

```

Although filling the delay slot with NOP instructions eliminates the need for hardware-controlled pipeline stalls in this case, it still is not a very efficient use of the pipeline stream since these additional NOP instructions increase code size and perform no useful work. (In practice, however, this technique need not have much negative impact on performance.)

A more effective solution to handling the data dependency is to fill the load delay slot with a useful instruction. Good optimizing compilers can usually accomplish this, especially if

the load delay is only one instruction. Below example program illustrates how a compiler might rearrange instruction to handle a potential data dependency.

```
# Consider the code for C := A+B; F := D
Load  R1, A
Load  R2, B
Add   R2, R1, R2    <= This instruction stalls because R2 data is not available
Load  R4, D
.....
# An alternative code sequence (where delay length = 1)
Load  R1, A
Load  R2, B
Load  R4, D
Add   R3, R1, R2    <= No stall since R2 data is available
```

(4) Delayed Branch Instructions

Branch instructions usually delay the instruction pipeline because the processor must calculate the effective destination of the branch and fetch that instruction. When a cache access requires an entire cycle, and the fetched branch instruction specifies the target address, it is impossible to perform this fetch (of the destination instruction) without delaying the pipeline for at least one pipe stage (one cycle). Conditional branches can cause further delays because they require the calculation of a condition, as well as the target address.

Instead of stalling the instruction pipeline to wait for the instruction at the target address, RISC designs typically use an approach similar to that used with Load instruction: Branch instructions are delayed and do not take effect until after one or more instructions immediately following the Branch instruction have been executed. The instruction or instructions immediately following the Branch instruction (delay instruction) have been executed. Branch and delayed branch instruction are illustrated in Figure 1.4

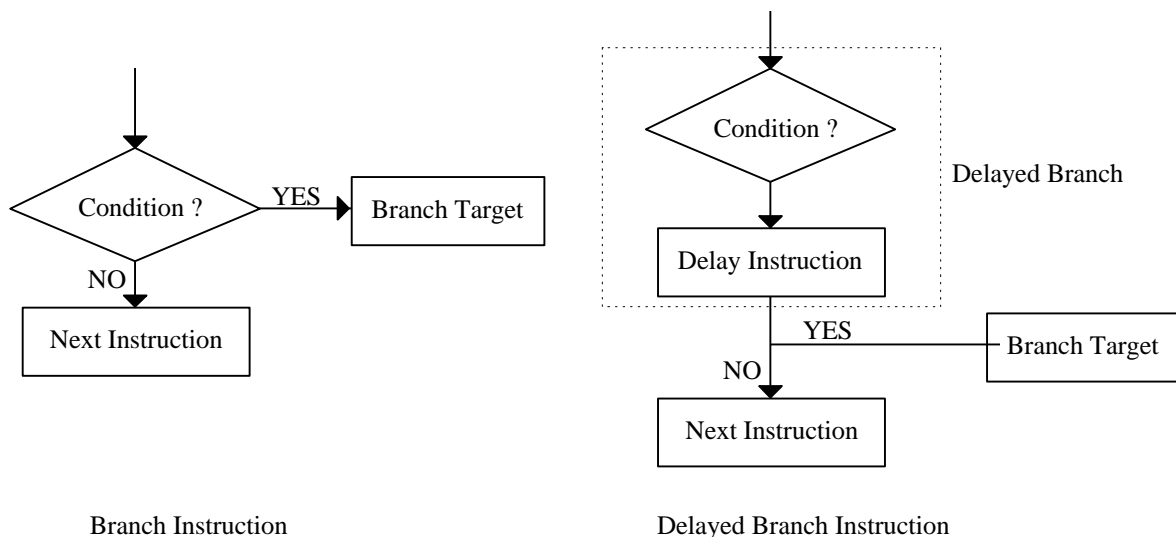

Figure 1.4: Block Diagram of Branch/Delayed Branch Instruction

1.1.3 The pipeline structure of GMS30C2132

GMS30C2132 has a two-stage pipeline structure and each stage is composed of two phases (TM and TV). The basic structure of GMS30C2132 pipeline is two-stage pipeline, but actually it is lengthened by the need of some instruction. As an example, standard ALU instruction uses 5 phases (2 stage pipeline (4 phases) + additional 1 phase). This additional phase doesn't use the datapath that is used next instruction, so next instruction execution need not wait until previous ALU instruction is ended. DSP instruction takes over 2 stage pipeline for execution, and requires same resource in the datapath that is required to next DSP instruction. So next DSP instruction is delayed.

The pipeline structure of GMS30C2132 and the action of datapath are described in Table 1.1.

Stage	Phase	Datapath Action
Fetch/Decode	TM (Low)	1. The instruction is read from the instruction cache according to the address of instruction.
	TV (High)	2. The control signal of Rd (destination operand) and Rs (source operand) is activated according to the instruction that was loaded in TM phase 2.1 The control signal of IR (immediate register (operand)) and IL (instruction length) is activated. 2.2 The address of next instruction is calculated and saved in PC
Execute/Write	TM (Low)	1. The next instruction is read from the instruction cache. 1.1 The address of Rs and Rs are determined. 1.2 The immediate operand is determined. 1.3 The operand is read from register stack using the address of Rs and Rd. 1.4 The operand XR, YR and QR are controlled.
	TV (High)	2. The input data of ALU is attained. 2.1 The control of ALU datapath is made and instruction is executed in ALU. 2.2 The result of ALU operation is saved in the register file.
Additional Insertion	Next TM	Additional ALU operation is continued and its result is saved in the register file.

Table 1.1: The pipeline structure of GMS30C2132 and the action of datapath.

1.2 Global Register Set

The architecture provides 32 global registers of 32 bit each. These are:

G0	Program Counter PC
G1	Status Register SR
G2	Floating-point Exception Register FER
G3..G15	General purpose registers
G16..G17	Reserved
G18	Stack Pointer SP
G19	Upper stack Bound UB
G20	Bus Control Register BCR (see section 6. Bus Interface)
G21	Timer Prescaler Register TPR (see section 5. Timer)
G22	Timer Compare Register TCR (see section 5. Timer)
G23	Timer Register TR (see section 5. Timer)
G24	Watchdog Compare Register WCR (see section 6. Bus Interface)
G25	Input Status Register ISR (see section 6. Bus Interface)
G26	Function Control Register FCR (see section 6. Bus Interface)
G27	Memory Control Register MCR (see section 6. Bus Interface)
G28..G31	Reserved

Registers G0..G15 can be addressed directly by the register code (0..15) of an instruction. Registers G18..G27 can be addressed only by a MOV or MOVI instruction with the high global flag H set to 1.

(Example)

MOVI G2, 0x20 ; G2 := 0x20 (set H flag)

MOV G3, G19 ; G3 := G19 (G19 (UB) is copied to G3)

	31	0
G0	Program Counter PC	
G1	Status Register SR	
G2	Floating-Point Exception Register FER	
G3	General Purpose Registers G3..G15	
G15		
G16	Reserved	
G17	Reserved	
G18	Stack Pointer SP	0 0
G19	Upper Stack Bound UB	0 0
G20	Bus Control Register BCR	
G21	Timer Prescaler Register TPR	
G22	Timer Compare Register TCR	
G23	Timer Register TR	
G24	Watchdog Compare Register WCR	
G25	Input Status Register ISR	
G26	Function Control Register FCR	
G27	Memory Control Register MCR	
G28	G28..G31 Reserved	
G31		

Figure 1.5: Global Register Set

1.2.1 Program Counter PC, G0

G0 is the program counter PC. It is updated to the address of the next instruction through instruction execution. Besides this implicit updating, the PC can also be addressed like a regular source or destination register. When the PC is referenced as an operand, the supplied value is the address of the first byte after the instruction which references it (the address of next instruction), except when referenced by a delay instruction with a preceding delayed branch taken. At delay branch instruction, when the branch condition is met, place the branch address $PC + rel$ (relative to the address of the first byte after the Delayed Branch Instruction) in the PC (see [section 3.26. Delayed Branch Instructions](#)).

Placing a result in the PC has the effect of a branch taken. When branch is taken, the target address of branch is placed in PC.

Bit zero of the PC is always zero, regardless of any value placed in the PC.

1.2.2 Status Register SR, G1

G1 is the status register SR. Its content is updated by instruction execution. Besides this implicit updating, the SR can also be addressed like a regular register (when H flag is set). When addressed as source or destination operand, all 32 bits are used as an operand. However, only bits 15..0 of a result can be placed in bits 15..0 of the SR, bits 31..16 of the result are discarded and bits 31..16 of the SR remain unchanged. When SR addressed as source operand, it represents 0x0 value. The full content of the SR is replaced only by the Return Instruction. A result placed in the SR overrules any setting or clearing of the condition flags as a result of an instruction.

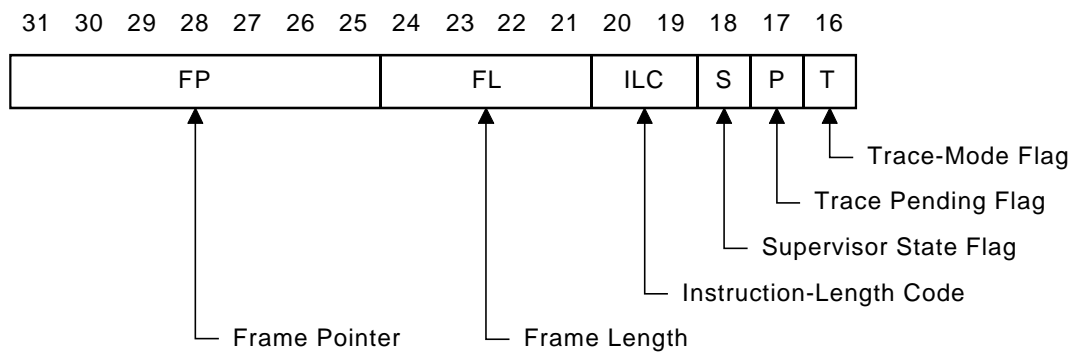

Figure 1.6: Status Register SR (bits 31..16)

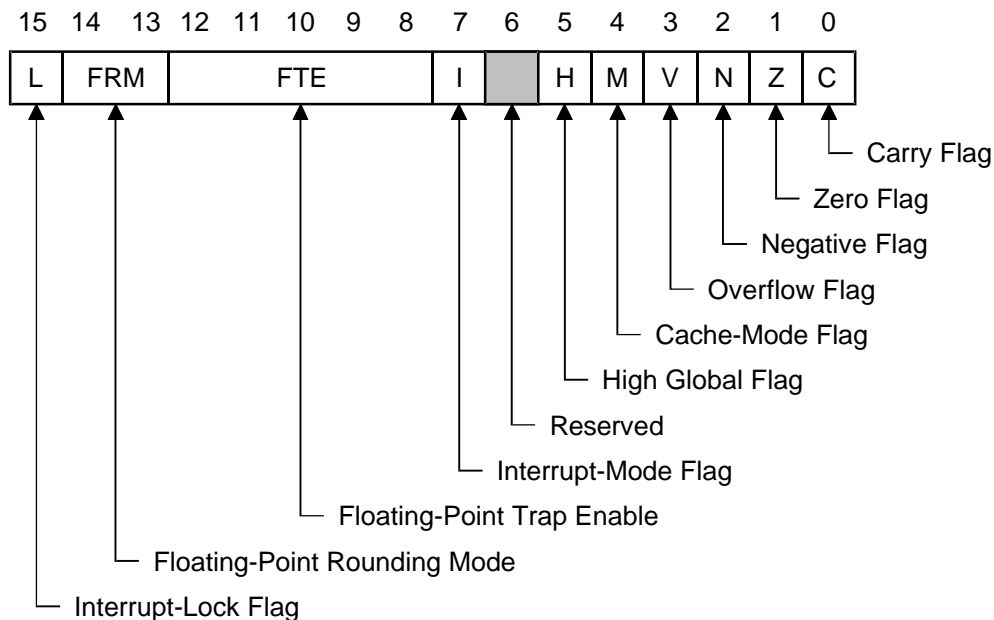

Figure 1.7: Status Register SR (bits 15..0)

1.2.2 Status Register SR, G1 (continued)

The status register SR contains the following status information:

- C** Carry Flag. Bit zero is the carry condition flag C. In general, when set it indicates that the unsigned integer range is exceeded (overflow). At add operations, it indicates a carry out of bit 31 of the result. At subtract operations, it indicates a borrow (inverse carry) into bit 31 of the result.
- Z** Zero Flag. Bit one is the zero condition flag Z. When set, it indicates that all 32 or 64 result bits are equal to zero regardless of any carry, borrow or overflow.
- N** Negative Flag. Bit two is the negative condition flag N. On compare instructions, it indicates the arithmetic correct (true) sign of the result regardless of an overflow. On all other instructions, it is derived from result bit 31, which is the true sign bit when no overflow occurs. In the case of overflow, result bit 31 and N reflect the inverted sign bit.
- V** Overflow Flag. Bit three is the overflow condition flag V. In general, when set it indicates a signed overflow. At the Move instructions, it indicates a floating-point NaN (Not a Number).
- M** Cache-Mode Flag. Bit four is the cache-mode flag M. Besides being set or cleared under program control, it is also automatically cleared by a Frame instruction and by any branch taken except a delayed branch. See [section 1.8. Instruction Cache](#) for details.
- H** High Global Flag. Bit five is the high global flag H. When H is set, denoting G0..G15 addresses G16..G31 instead. Thus, the registers G18..G27 may be addressed by denoting G2..G11 respectively.
The H flag is effective only in the first cycle of the next instruction after it was set; then it is cleared automatically.
Only the MOV or MOVI instruction issued as the next instructions must be used to copy the content of a local register or an immediate value to one of the high global registers. The MOV instruction may be used to copy the content of a high global register (except the BCR, TPR, FCR and MCR register, which are write-only) to a local register. With all other instructions, the result may be invalid.
If one of the high global registers is addressed as the destination register in user state ($S = 0$), the condition flags are undefined, the destination register remains unchanged and a trap to Privilege Error occurs.
- Reserved** Bit six is reserved for future use. It must always be zero.
- I** Interrupt-Mode Flag. Bit seven is the interrupt-mode flag I. It is set automatically on interrupt entry and reset to its old value by a Return instruction. The I flag is used by the operating system; it must be never changed by any user program.
- FTE** Floating-Point Trap Enable Flag. Bits 12..8 are the floating-point trap enable flags They determine the Exception type and Trap execution flow(see [section 3.33.2. Floating-Point Instructions](#)).

1.2.2 Status Register SR, G1 (continued)

- FRM** Floating-Point Rounding Mode. Bits 14..13 are the floating-point rounding modes (see [section 3.33.2. Floating-Point Instructions](#)).
- L** Interrupt-Lock Flag. Bit 15 is the interrupt-lock flag L. When the L flag is one, all Interrupt, Parity Error and Extended Overflow exceptions are inhibited regardless of individual mode bits. The state of the L flag is effective immediately after any instruction that changed it. The L flag is set to one by any exception.
- The L flag can be cleared or kept set in any or on return to any privilege state (user or supervisor). Changing the L flag from zero to one is privileged to supervisor or return from supervisor to supervisor state. A trap to Privilege Error occurs if the L flag is set under program control from zero to one in user or on return to user state.

The following status information can be changed only internally or replaced by the saved return value of the SR via a Return instruction:

- T** Trace-Mode Flag. Bit 16 is the trace-mode flag T. When both the T flag and the trace pending flag P are one, a trace exception occurs after every instruction except after a Delayed Branch instruction. The T flag is cleared by any exception.
- Note: The T flag can only be changed in the saved return SR and is then effective after execution of a Return instruction.*
- P** Trace Pending Flag. Bit 17 is the trace pending flag P. It is automatically set to one by all instructions except by the Return instruction, which restores the P flag from bit 17 of the saved return SR.
- Since for a Trace exception both the P and the T flag must be one, the P flag determines whether a trace exception occurs ($P = 1$) or does not occur ($P = 0$) immediately after a Return instruction that restored the T flag to one.
- When an instruction is ended, the T and P flag set to one. Therefore trace exception is occurred. After trace exception trap is ended the process returns to main program, and if T and P flag is set to one, trace exception occurs again. To avoid tracing the same instruction in an endless loop, the P flag is cleared at return instruction in trace exception trap routine.
- Note: The P flag can only be changed in the saved SR. No program except the trace exception handler should affect the saved P flag. The trace exception handler must clear the saved P flag to prevent a trace exception on return, in order to avoid tracing the same instruction in an endless loop.*
- S** Supervisor State Flag. Bit 18 is the supervisor state flag S (see [section 1.4. Privilege States](#)). The S flag determine whether user state ($S=0$) or supervisor state ($S=1$). It is set to one by any exception.
- ILC** Instruction-Length Code. Bits 20 and 19 represent the instruction-length code ILC. It is updated by instruction execution. The ILC holds (in general) the length of the last instruction: ILC values of one, two or three represent an instruction length of one, two or three half words respectively. After a branch taken, the ILC is invalid. The Return instruction clears the ILC.

1.2.2 Status Register SR, G1 (continued)

Note: Since a Return instruction following an exception clears the ILC, a program must not rely on the current value of the ILC.

FL Frame Length. Bits 24..21 represent the frame length FL. The FL holds the number of usable local registers (maximum 16) assigned to the current stack frame. FL = 0 is always interpreted as FL = 16.

FP Frame Pointer. Bits 31..25 represent the frame pointer FP. The least significant six bits of the FP point to the beginning of the current stack frame in the local register set, that is, they point to L0.

The FP contains bit 8..2 of the address at which the content of L0 would be stored if pushed onto the memory part of the stack.

1.2.3 Floating-Point Exception Register FER, G2

G2 is the floating-point exception register. All bits must be cleared to zero after Reset. Only bits 12..8 and 4..0 may be changed by a user program, all other bits must remain unchanged.

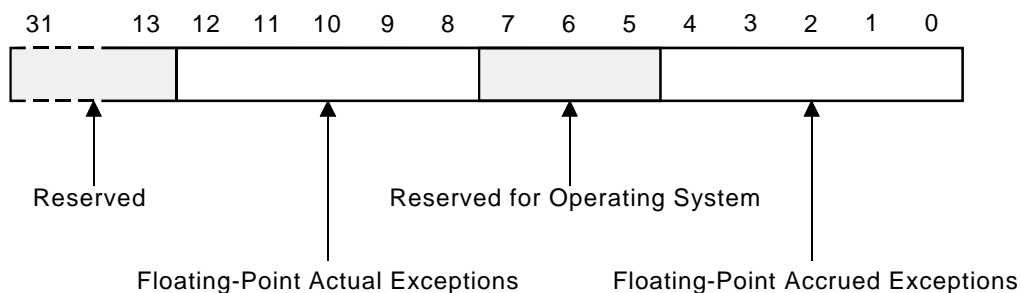

Figure 1.8: Floating-Point Exception Register

The floating-point trap enable flags FTE and the exception flags are assigned as:

floating-point trap enable FTE	accrued exceptions	actual exceptions	exception type
SR(12)	G2(4)	G2(12)	Invalid Operation
SR(11)	G2(3)	G2(11)	Division by Zero
SR(10)	G2(2)	G2(10)	Overflow
SR(9)	G2(1)	G2(9)	Underflow
SR(8)	G2(0)	G2(8)	Inexact

The reserved bits G2(31..13) and G2(7..5) must be zero.

A floating-point instruction, except a Floating-point Compare, can raise any of the exceptions Invalid Operation, Division by Zero, Overflow, Underflow or Inexact. FCMP and FCMPD can raise only the Invalid Operation exception (at unordered). FCMPU and FCMPUD cannot raise any exception.

At an exception, the following additional action is performed:

- i ü Any corresponding accrued-exception flag whose corresponding trap-enable flag is zero (not enabled) is set to one; all other accrued-exception flags remain unchanged.
- i ü If a corresponding trap-enable flag is one (enabled), any corresponding actual-exception flag is set to one; all other actual-exception flags are cleared. The destination remains unchanged.

In the present software version, the software emulation routine must branch to the corresponding user-supplied exception trap handler. The (modified) result, the source operand, the stack address of the destination operand and the address of the floating-point instruction are passed to the trap handler. In the future hardware version, a trap to Range Error will occur; the Range Error handler will then initiate re-execution of the floating-point instruction by branching to the entry of the corresponding software emulation routine, which will then act as described before.

The only exceptions that can coincide are Inexact with Overflow and Inexact with Underflow. An Overflow or Underflow trap, if enabled, takes precedence over an Inexact trap; the Inexact accrued-exception flag G2(0) must then be set as well.

1.2.4 Stack Pointer SP, G18

G18 is the stack pointer SP. The SP contains the top address + 4 of the memory part of the stack, that is the address of the first free memory location in which the first local register would be saved by a push operation (see [section 3.29. Frame Instruction](#) for details). Stack growth is from low to high address.

Bits one and zero of the SP must always be cleared to zero. The SP can be addressed only via the high global flag H being set. Copying an operand to the SP is a privileged operation.

Note: Stack Pointer SP contains the top address + 4 of the memory part of the stack (memory part stack), and Frame Pointer FP points to the beginning of the current stack frame in the local register set (register part stack).

1.2.5 Upper Stack Bound UB, G19

G19 is the upper stack bound UB. The UB contains the address beyond the highest legal memory stack location. It is used by the Frame instruction to inhibit stack overflow.

Bits one and zero of the UB must always be cleared to zero. The UB can be addressed only via the high global flag H being set. Copying an operand to the UB is a privileged operation.

1.2.6 Bus Control Register BCR, G20

G20 is the write-only bus control register BCR. Its content defines the options possible for bus cycle, parity and refresh control. The BCR defines the parameters (bus timing, refresh control, page fault and parity error disable) for accessing external memory located in address spaces MEM0..MEM3. The BCR can be addressed only via the high global flag H being set. Copying an operand to the BCR is a privileged operation. The BCR register is described in detail in the bus interface description in [section 6](#).

1.2.7 Timer Prescaler Register TPR, G21

G21 is the write-only timer prescaler register TPR. It adapts the timer clock to different processor clock frequencies. The TCR can be addressed only via the high global flag H being set. Copying an operand to the TPR is a privileged operation. The TPR is described in the timer description in [section 5](#).

1.2.8 Timer Compare Register TCR, G22

G22 is the timer compare register TCR. Its content is compared continuously with the content of the timer register TR. The TCR can be addressed only via the high global flag H being set. Copying an operand to the TCR is a privileged operation. The TCR is described in the timer description in [section 5](#).

1.2.9 Timer Register TR, G23

G23 is the timer register TR. Its content is incremented by one on each time unit. The TR can be addressed only via the high global flag H being set. Copying an operand to the TR is a privileged operation. The TR is described in the timer description in [section 5](#).

1.2.10 Watchdog Compare Register WCR, G24

G24 is the watchdog compare register WCR. The WCR can be addressed only via the high global flag H being set. The WCR is used by the IO3 control mode (Watchdog Mode $FCR(13) = 1$, $FCR(12) = 0$). Copying an operand to the WCR is a privileged operation. The WCR is described in the bus interface description in [section 6](#).

1.2.11 Input Status Register ISR, G25

G25 is the read-only input status register ISR. The ISR reflects the input levels at the pins IO1..IO3 as well as the input levels at the four interrupt pins INT1..INT4 and contains the EvenFlag and the EqualFlag. The ISR can be addressed only via the high global flag H being set. The ISR is described in the bus interface description in [section 6](#).

1.2.12 Function Control Register FCR, G26

G26 is the write-only function control register FCR. The FCR controls the polarity and function of the I/O pins IO1..IO3 and the interrupt pins INT1..INT4, the timer interrupt mask and priority, the bus lock and the Extended Overflow exception. The FCR can be addressed only via the high global flag H being set. Copying an operand to the FCR is a privileged operation. The FCR is described in the bus interface description in [section 6](#).

1.2.13 Memory Control Register MCR, G27

G27 is the write-only memory control register MCR. The MCR controls additional parameters for the external memory, the internal memory refresh rate, the mapping of the entry table and the processor power management. The MCR can be addressed only via the high global flag H being set. Copying an operand to the MCR is a privileged operation. The MCR is described in the bus interface description in [section 6](#).

1.3 Local Register Set

The architecture provides a set of 64 local registers of 32 bits each. The local registers 0..63 represent the register part of the stack, containing the most recent stack frame(s).



Figure 1.9: Local Register Set 0..63

The local registers can be addressed by the register code (0..15) of an instruction as L0..L15 only relative to the frame pointer FP; they can also be addressed absolutely as part of the stack in the stack address mode (see [section 3.1.1. Address Modes](#)).

The absolute local register address is calculated from the register code as:

$$\text{absolute local register address} := (\text{FP} + \text{register code}) \text{ modulo } 64.$$

That is, only the least significant six bits of the sum $\text{FP} + \text{register code}$ are used and thus, the absolute local register addresses for L0..L15 wrap around modulo 64. The local register set organized as a circular buffer.

The absolute local register addresses for **FP + register code + 1** or **FP + FL + offset** are calculated accordingly.

The least significant six bits of Frame Pointer FP point to the beginning of the current stack (L0).

1.4 Privilege States

The architecture provides two privilege states, determined by the supervisor state flag *S*: User state ($S = 0$) and supervisor state ($S = 1$).

The privilege state may be used by an external memory management unit to control memory and I/O accesses. The operating system kernel is executed in the higher privileged supervisor state, thereby restricting access to all sensitive data to a highly reliable system program. The following operations are also privileged to be executed only in the supervisor or on return from supervisor to supervisor state:

- Copying an operand to any of the high global registers
- Changing the interrupt-lock flag *L* from zero to one
- Returning through a Return instruction to supervisor state

Any illegal attempt causes a trap to Privilege Error.

The *S* flag is also saved in bit zero of the saved return PC by the Call, Trap and Software instructions and by an exception. At Call instruction (CALL *Ld*, *Rs*, *const*) the old PC and the *S* flag is saved in *Ld* and the old SR is saved in *Ldf*. A Return instruction restores it from this bit position to the *S* flag in bit position 18 of the SR (thereby overwriting the bit 18 returned from the saved return SR).

If a Return instruction attempts a return from user to supervisor state, a trap to Privilege Error occurs ($S = 1$ is saved).

Returning from supervisor to user state is achieved by clearing the *S* flag in bit zero of the saved return PC before return. Switching from user to supervisor state is only possible by executing a Trap instruction or by exception processing through one of the 64 supervisor subprogram entries (see [section 2.4. Entry Tables](#)).

Note: Since the Return instruction restores the PC first to enable the instruction fetch to start immediately, the restored S flag must also be available immediately to prevent any memory access with a false privilege state. The S flag is therefore packed in bit zero of the saved return PC.

The state of the *S* flag can be signaled at the IO1 pin in each memory or I/O cycle.

1.5 Register Data Types

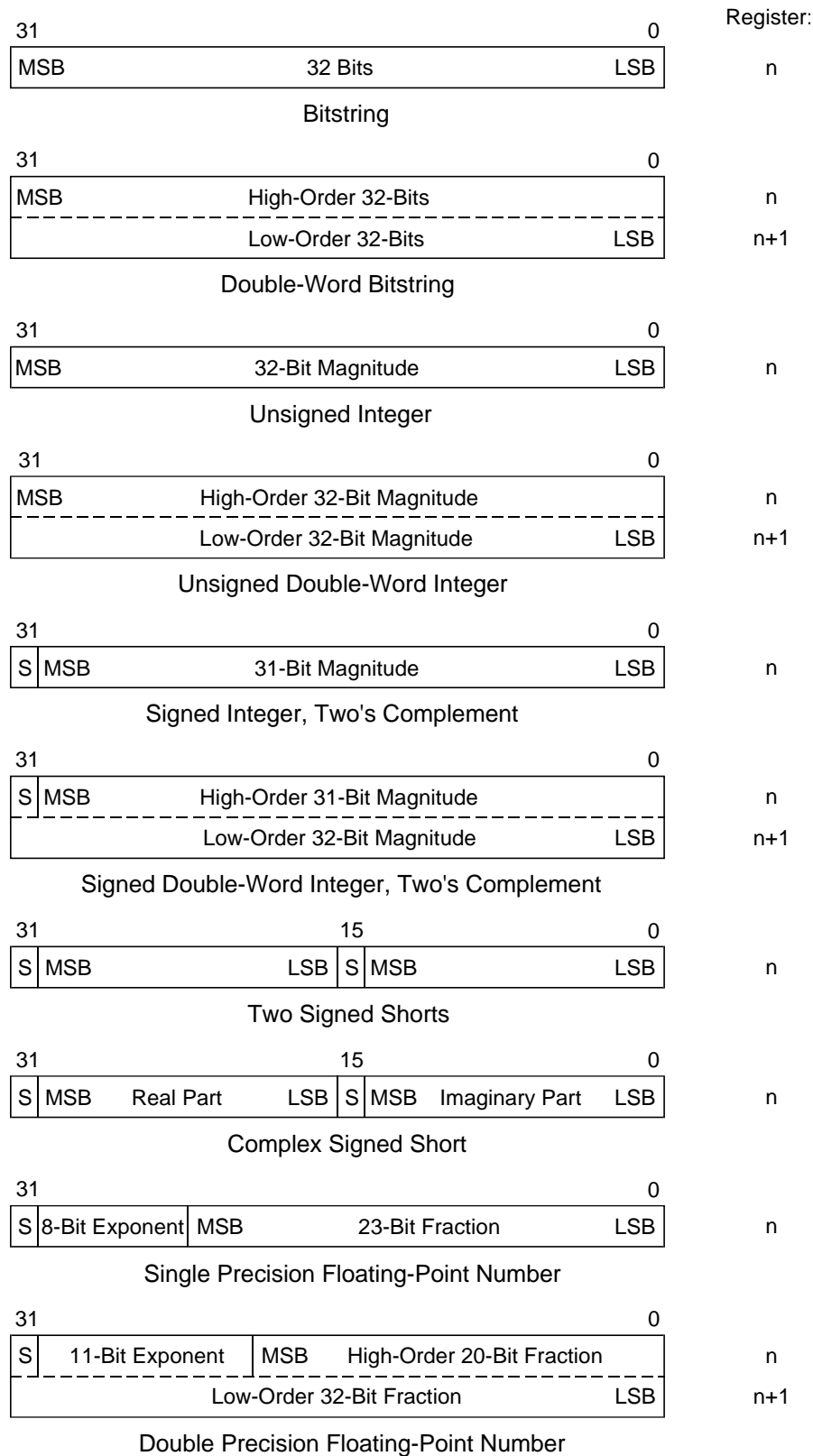

S = sign bit, MSB = most significant bit, LSB = least significant

Figure 1.10: Register Data Types.

1.6 Memory Organization

The architecture provides a memory address space in the range of $0..2^{32} - 1$ ($0..4,294,967,295$) 8-bit bytes (4GByte). Memory is implied to be organized as 32-bit words. The following memory data types are available (see figure 1.10)

- ; `ü`Byte unsigned (unsigned 8-bit integer, bit-string or character)
- ; `ü`Byte signed (signed 8-bit integer, two's complement)
- ; `ü`Half word unsigned (unsigned 16-bit integer or bit-string)
- ; `ü`Half word signed (signed 16-bit integer, two's complement)
- ; `ü`Word (32-bit undedicated word)
- ; `ü`Double-Word (64-bit undedicated double-word)

Besides the memory address space, a separate I/O address space is provided. In the I/O address space, only word and double-word data types are available.

Words and double-words must be located at word boundaries, that is, their most significant byte must be located at an address whose two least significant bits are zero (`...xx00`). Half words must be located at half word boundaries, their most significant byte being located at an address whose least significant bit is zero (`...xx0`). Bytes may be located at any address.

The variable-length instructions are located as contiguous sequences of one, two or three half words at half word boundaries.

Memory- and I/O-accesses are pipelined to an implied depth of two addresses.

Note: All data is located high to low order at addresses ascending from low to high, that is, the high order part of all data is located at the lower address (Big endian). This scheme should also be used for the addressing of bit arrays. Though the most significant bit of a word is numbered as bit position 31 for convenience of use, it should be assigned the bit address zero to maintain consistent bit addressing in ascending order through word boundaries.

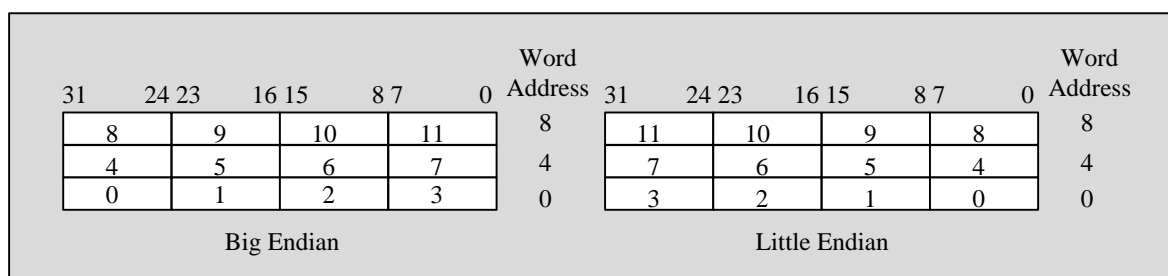

Figure 1. 11: Address of bytes within words: Big-endian and little endian alignment.

1.6 Memory Organization (continued)

Figure 1.12 shows the location of data and instructions in memory relative to a binary address $n = \dots xxx00$ ($x = 0$ or 1). The memory organization is big-endian.

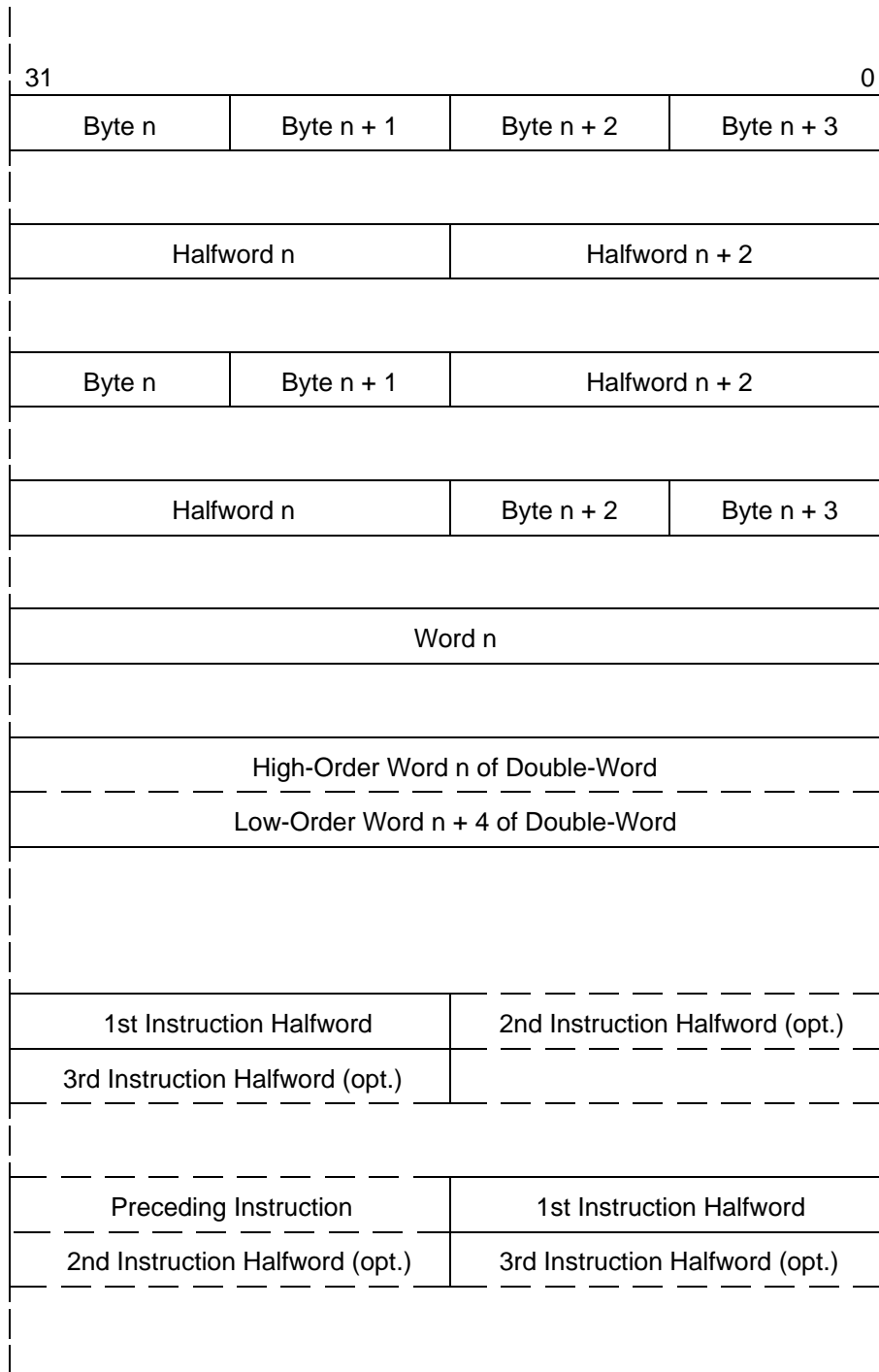

Figure 1. 12: Memory Organization

At all data types, the most significant bit is located at the higher and the least significant bit at the lower bit position.

1.7 Stack

A runtime stack, called stack here, holds generations of local variables in last-in-first-out (LIFO) order. A generation of local variables, called stack frame or activation record, is created upon subprogram entry and released upon subprogram return.

The runtime stack provided by the architecture is divided into a memory part and a register part. The register part of the stack, implemented by a set of 64 local registers organized as a circular buffer, holds the most recent stack frame(s). The current stack frame is always kept in the register part of the stack. The frame pointer FP points to the beginning of the current stack frame (addressed as register L0). The frame length FL indicates the number of registers (maximum 16) assigned to the current stack frame. The stack grows from low to high address. It is guarded by the upper stack bound UB.

The stack is maintained as follows:

- A Call, Trap or Software instruction increments the FP and sets FL to six, thus creating a new stack frame with a length of six registers (including the return PC and the return SR).
- An exception increments the FP by the value of FL and then sets FL to two.
- A Frame instruction restructures a stack frame to include (optionally) passed parameters by decrement the FP and by resetting the FL to the desired length, and restores a reserve of 10 local registers for the next subprogram call. If the required number of registers + 10 do not fit in the register part of the stack, the contents of the differential (required + 10 - available) number of local registers are pushed onto the memory part of the stack. A trap to Frame Error occurs after the push operation when the old value of the stack pointer SP exceeded the upper stack bound UB. The passed parameters are located from L0 to the required number of register to be saved passed parameters.
Note: A Frame instruction must be executed before executing any other Call, Trap or Software instruction or before the interrupt-lock flag L is being cleared, otherwise the beginning of the register part of the stack at the FP could be overwritten without any warning.
- A Return instruction releases the current stack frame and restores the preceding stack frame. If the restored stack frame is not fully contained in the register part of the stack, the content of the missing part of the stack frame is pulled from the memory part of the stack.

For more details see the descriptions of the specific instructions.

When the number of local registers required for a stack frame exceeds its maximum length of 16 (in rare cases), a second runtime stack in memory may be used. This second stack is also required to hold local record or array data.

The stack is used by routines in user or supervisor state, that is, supervisor stack frames are appended to user stack frames, and thus, parameters can be passed between user and supervisor state. A small stack space must be reserved above UB. UB can then be set to a higher value by the Frame Error handler to free stack space for error handling.

1.7 Stack (continued)

Because the complete stack management is accomplished automatically by the hardware, programming the stack handling instructions is easy and does not require any knowledge of the internal working of the stack.

The following example demonstrates how the Call, Frame and Return instructions are applied to achieve the stack behavior of the register part of the stack shown in the figures 1.13 and 1.14. Figure 1.13 shows the creation and release of stack frames in the register part of the stack.

Program Example:

```

A:  FRAME   L13, L3      ; set frame length FL = 13, decrement FP by 3
    :       ; parameters passed to A can be addressed
    :       ; in L0, L1, L2
    :
    :
    code of function A
    :
    :
    MOV     L7, L5      ; copy L5 to L7 for use as parameter1
    MOVI    L8, 4       ; set L8 = 4 for use as parameter2
    CALL    L9, 0, B    ; call function B,
    :         ; save return PC, return SR in L9, L10
    :
    :
    MOVI    L0, 20      ; set L0 = 20 as return parameter for caller
    RET     PC, L3      ; return to function calling A,
    :         ; restore frame of caller

B:  FRAME   L11, L2      ; set frame length FL = 11, decrement FP by 2
    :       ; passed parameter1 can now be addressed in L0
    :       ; passed parameter2 can now be addressed in L1
    :
    :
    code of function B
    :
    :
    RET     PC, L2      ; return to function A, frame A is restored by
    :         ; copying return PC and return SR in L2 and L3
    :         ; of frame B to PC and SR

```

1.7 Stack (continued)

<p style="text-align: center;">Return from B</p> <pre> PC := ret. PC for B; SR := ret. SR for B; -- returns preceding stack frame if stack frame contained in local registers then next instruction; else pull contents of differential words from memory part of the stack; </pre>	<p style="text-align: center;">Call B</p> <pre> PC := branch address; ret. PC for B := old PC; ret. SR for B := old SR; FP := FP + reg.code of ret. PC; FL := 6; -- reg.code of ret. PC = 9 </pre>	<p style="text-align: center;">Frame in B</p> <pre> FP := FP - code of source reg.; FL := code of dest.reg.; if available registers ≥ (required + 10) registers then next instruction else push contents of differential number of registers to memory part of stack; -- code of source reg. = 2 -- code of dest.reg. = 11 </pre>
---	--	---

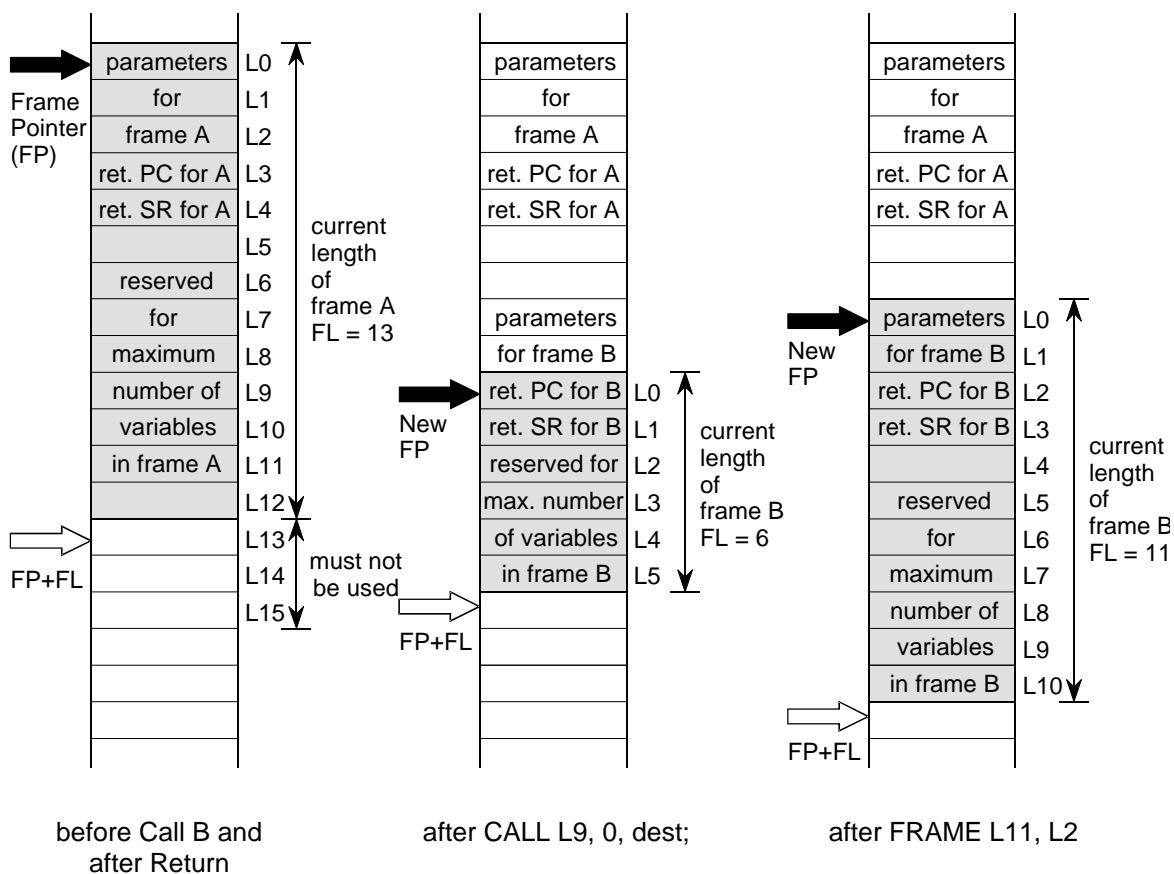

Figure 1.13: Stack frame handling (register part)

1.7 Stack (continued)

A currently activated function A has a frame length of $FL = 13$, $FL = 3$ (required to save passed parameters) + 10(received). Registers L0..L6 are to be retained through a subsequent call, registers L7..L12 are temporaries. A call to function B needs 2 parameters to be passed. The parameters are placed by function A in registers L7 and L8 before calling B. The Call instruction addresses L9 as destination for the return PC and return SR register pair to be used by function B on return to function A.

On entry of function B, the new frame of B has an implicit length of $FL = 6$. It starts physically at the former register L9 of frame A. However, since the frame pointer FP has been incremented by 9 by the Call instruction, this register location is now being addressed as L0 of frame B. The passed parameters cannot be addressed because they are located below the new register L0 of frame B. To make them addressable, a Frame instruction decrements the frame pointer FP by 2. Then, parameter 1 and 2 passed to B can be addressed as registers L0 and L1 respectively. Note that the return PC is now to be addressed as L2!

The Frame instruction in B specifies also the new, complete frame length $FL = 11$ (including the passed parameters as well as the return PC and return SR pair). Besides, a new reserve of 10 registers for subsequent function calls and traps is provided in the register stack. A possible overflow of the register stack is checked and handled automatically by the Frame instruction. A program needs not and must not pay attention to register stack overflow.

At the end of function B, a Return instruction returns control to function A and restores the frame A. A possible underflow of the register stack is handled also automatically; thus, the frame A is always completely restored, regardless whether it was wholly or partly pushed into the memory part of the stack before (in the case when B called other functions).

In the present example with the frame length of $FL = 13$, any suitable destination register up to L13 could be specified in the Call instruction. The parameters to be passed to the function B would then be placed in L11 and L12. It is even possible to append a new frame to a frame with a length of $FL = 16$ (coded as $FL = 0$ in the status register SR): the destination register in the Call instruction is then coded as L0, but interpreted as the register past L15.

See also [sections 3.27. Call instruction](#), [3.29. Frame instruction](#) and [3.30. Return instruction](#) for further details.

Note: With an average frame length of 8 registers, ca. 7..8 Frame instructions succeed a pulling Return instruction until a push occurs and 7..8 Return instructions succeed a pushing Frame instruction until a pull occurs. Thus, the built-in hysteresis makes pushing and pulling a rare event in regular programs!

Figure 1.14 represents the stack frame pushing and popping. When the register part of the stack A and X overlapped modulo 64 (the register part of stack was full), the frame instruction for frame X pushed the number of words in frame A to the memory part of the stack according to the space required for frame X. When the process returned to frame A, the return instruction pulled the number of words from the memory part of the stack to the register part of the stack.

1.7 Stack (continued)

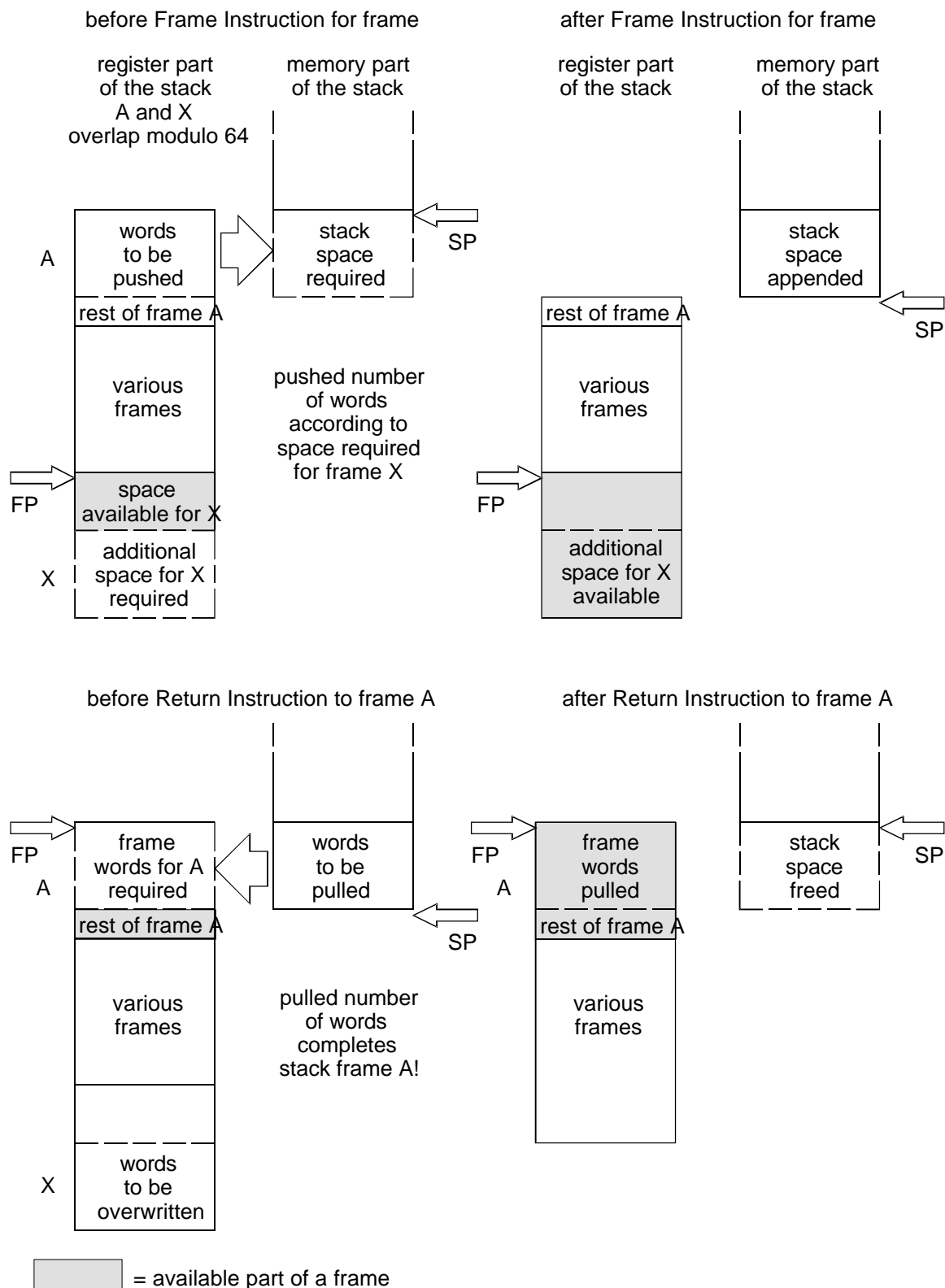

Figure 1.14: Stack frame pushing and popping

1.8 Instruction Cache

The instruction cache is transparent to programs. A program executes correctly even if it ignores the cache, whereby it is assumed that the instruction code is not modified in the local range contained in the cache.

The instruction cache holds a total of up to 128 bytes (32 unstructured 32-bit words of instructions). It is implemented as a circular buffer that is guarded by a look-ahead counter and a look-back counter. The look-ahead counter holds the highest and the look-back counter the lowest address of the instruction words available in the cache. The cache-mode flag M is used to optimize special cases in loops (see details below). The cache can be regarded as a temporary local window into the instruction sequence, moving along with instruction execution and being halted by the execution of a program loop.

- **Look-Ahead Counter:** It holds the highest address of instruction word in the instruction cache (the start address of the instruction cache). Bits 6..2 of the look-ahead counter represent the location of the prefetched instruction to be saved in the instruction cache.
- **Look-Back Counter:** It holds the lowest address of instruction word in the instruction cache (the end address of the instruction cache).
- **Cache Mode Flag M:** It represents whether the instruction cache is available (M=1) or flushed (M=0). It is automatically cleared by a Frame instruction and by any branch taken except a delayed branch.

Its function is as follows:

The prefetch control loads unstructured 32-bit instruction words (without regard to instruction boundaries) from memory into the cache. The load operation is pipelined to a depth of two stages (see [section 1.1.1 The pipeline structure of GMS30C2132](#) for details of the instruction pipeline). The look-ahead counter is incremented by four at each prefetch cycle. It always contains the address of the last instruction word for which an address bus cycle is initiated, regardless of whether the addressed instruction word is in the load pipeline or already loaded into the instruction cache.

The prefetched instruction word is placed in the cache word location addressed by bits 6..2 of the look-ahead counter. The look-back counter remains unchanged during prefetch unless the cache word location, it addresses with its bits 6..2, is overwritten by a prefetched instruction word. In this case, it is incremented by four to point to the then lowest-addressed usable instruction word in the cache. Since the cache is implemented as a circular buffer, the cache word addresses derived from bits 6..2 of the look-ahead and look-back counter wrap around modulo 32.

The prefetch is halted:

- When eight words are prefetched, that is, eight words are available (including those pending in the load pipeline) in the prefetch sequence succeeding the instruction word addressed by the program counter PC through the instruction word addressed by the look-ahead counter. Prefetch is resumed when the PC is advanced by instruction execution.

1.8 Instruction Cache (continued)

- In the cycle preceding the execution cycle of a memory instruction or any potentially branch-causing instruction (regardless of whether the branch is taken) except a forward Branch or Delayed Branch instruction with an instruction length of one half word and a branch target contained in the cache. Halting the prefetch in these cases avoids filling the load pipeline with demands for lower priority (compared to data) or potentially unnecessary instruction words.
- During the execution cycle of any instruction accessing memory or I/O.

Instruction decoding is as follows:

The cache is read in the decode cycle by using bits 6..1 of the PC as an address to the first half word of the instruction presently being decoded. The instruction decode needs and uses only the number (1, 2 or 3) of instruction half words defined by the instruction format. Since only the bits 6..1 of the PC are used for addressing, the half word addresses wrap around modulo 64. Idle wait cycles are inserted when the instruction is not or not fully available in the cache.

At an explicit Branch or Delayed Branch instruction:

At an explicit Branch or Delayed Branch instruction (except when placed as delay instruction) with an instruction length of one half word, the location of the branch target is checked. The branch target is treated as being in the cache when the target address of a backward branch is not lower than the address in the look-back counter and the target address of a forward branch is not higher than two words above the address in the look-ahead counter. That is, the two instruction words succeeding the instruction word addressed by the content of the look-ahead counter are treated by a forward branch as being in the cache. Their actual fetch overlaps in most cases with the execution of the branch instruction and thus, no cycles are wasted. When the branch target is in the cache, the look-back counter and the look-ahead counter remain unchanged.

When a branch is taken by a Delayed Branch instruction with an instruction length of one half word to a forward branch target not in the cache and the cache mode flag M is enabled (1), the look-back counter and the look-ahead counter remain unchanged. Wait cycles are then inserted until the ongoing prefetch has loaded the branch target instruction into the cache.

Any other branch taken flushes the cache by also placing the branch address in the look-back and the look-ahead counter. Prefetch then starts immediately at the branch address. Instruction decoding waits until the branch target instruction is fully available in the cache.

The cache mode flag M (bit four of the SR) can be set or cleared by logical instructions. It is automatically cleared by a Frame instruction and by any branch taken except a branch caused by a Delayed Branch or Return instruction; a Delayed Branch instruction leaves the M flag unchanged and a Return instruction restores the M flag from the saved status register SR.

Note: Since up to eight instruction words can be loaded into the cache by the prefetch, only 24 instruction words are left to be contained in a program loop. Thus, a program loop can have a maximum length of 96 or 94 bytes including the branch instruction closing the loop, depending on the even or odd half word address location of the first instruction of the loop respectively.

1.8 Instruction Cache (continued)

A forward Branch or Delayed Branch instruction with an instruction length of one half word into up to two instruction words succeeding the word addressed by the look-ahead counter treats the branch target as being in the cache and does not flush the cache. Thus, three or four instruction half words, depending on the odd or even half word address location of the branch instruction respectively, can always be skipped without flushing the cache.

Enabling the cache-mode flag M is only required when a program loop to be contained in the cache contains a forward branch to a branch target in the program loop and more than three (or four, see above) instruction half words are to be skipped. In this case, the enabled M flag in combination with a Delayed Branch instruction with an instruction length of one half word inhibits flushing the cache when the branch target is not yet prefetched.

Fetch instruction is as follows:

Since a single-word memory instruction halts the prefetch for two cycles, any sequence of memory instructions, even with interspersed one-cycle non-memory instructions, halts the prefetch during its execution. Thus, alternating between instruction and data memory pages is avoided. If the number of instruction half words required by such a sequence is not guaranteed to be in the cache at the beginning of the sequence, a Fetch instruction enforcing the prefetch of the sequence may be used. A Fetch instruction may also be used preceding a branch into a program loop; thus, flushing the cache by the first branch repeating the loop can be avoided.

At a Branch or Delayed Branch instruction with an instruction length of two half words:

A branch taken caused by a Branch or Delayed Branch instruction with an instruction length of two half words always flushes the instruction cache, even if the branch target is in the cache. Thus, branches can be forced to bypass the cache, thereby reducing the cache to a prefetch buffer. This reduced function can be used for testing.

The last nine words of a memory block (except at the highest ROM memory block) must not contain any instruction to be executed, otherwise the prefetch could overrun the memory limit.

1.9 On-Chip Memory (IRAM)

4KBytes of memory are provided on-chip. The on-chip-memory (IRAM) is mapped to the hex address C000 0000 of the memory address space and wraps around modulo 4K up to DFFF FFFF. The IRAM is implemented as dynamic memory, needing refresh (DRAM). The refresh rate must be specified in the MCR bits 18..16 (see section 6.4. Memory Control Register MCR) before any use (default is refresh disabled). The number given in MCR(18..16) specifies the refresh rate in CPU clock cycles; e.g. 128 specifies a refresh cycle automatically inserted every 128 clock cycles. Each refresh cycle refreshes 16 bytes, thus, 256 refresh cycles are required to refresh the whole IRAM. A high refresh rate does not degrade performance since the refresh cycles are inserted on idle IRAM cycles whenever possible.

An access to the IRAM bypasses the access pipeline of the external memory. Thus, pending external memory accesses do not delay accesses to the IRAM. The IRAM can hold data as well as instructions. Instruction words from the IRAM are automatically transferred to the instruction cache on demand; these transfers do not interfere with external memory accesses. Besides bypassing of the external memory pipeline, memory instructions accessing the IRAM behave exactly alike those accessing external memory. The minimum delay for a load access is one cycle; that is, the data is not available in the cycle after the load instruction. One or more wait cycles are automatically inserted if the target register of the load is addressed before the data is loaded into the target register.

Attention: For selection between an internal and external memory access, bits 31..29 of the specified address register are used before calculation of the effective address. Therefore, the content of the specified address register must point into the IRAM address range. The IRAM address range boundary must not be crossed when a displacement is being added.

2. Instructions General

2.1 Instruction Notation

In the following instruction-set presentation, an informal description of an instruction is followed by a formal description in the form:

Format	Notation	Operation
--------	----------	-----------

Format denotes the instruction format.

Notation gives the assembler notation of the instruction.

Operation describes the operation in a Pascal-like notation with the following symbols:

Ls denotes any of the local registers L0..L15 used as source register or as source operand. At memory Load instructions, Ls denotes the load destination register.

Ld denotes any of the local registers L0..L15 used as destination register or as destination operand.

Rs denotes any of the local registers L0..L15 or any of the global registers G0..G15 used as source register or as source operand. At memory Load, see Ls.

Rd denotes any of the local registers L0..L15 or any of the global registers G0..G15 used as destination register or as destination operand.

Lsf, Ldf, Rsf and Rdf denote the register or operand following after (with a register address one higher than) Ls, Ld, Rs and Rd respectively.

imm, const, dis, lim, rel, adr and n denote immediate operands (constants) of various formats and ranges.

Operand(x) denotes a single bit at the bit position x of an operand.

Example: Ld(31) denotes bit 31 of Ld.

Operand(x..y) denotes bits x through y of an operand.

Example: Ls(4..0) denotes bits 4 through 0 of Ls.

Expression[^] denotes an operand at a location addressed by the value of the expression. Depending on the context, the expression addresses a memory location or a local register.

Example: Ld[^] denotes a memory operand whose memory address is the operand Ld.

(FP + FL)[^] denotes a local register operand whose register address is FP + FL.

: = signifies the assignment symbol, read as "is replaced by".

// signifies the concatenation symbol. It denotes concatenation of two operand words to a double-word operand or concatenation of bits and bit-string.

Examples: Ld//Ldf denotes a double-word operand, 16 zeros//imm1 denotes expanding of an immediate half word by 16 leading zeros.

=, ≠, > and **<** denote the equal, unequal, greater than and less than relations.

Example: The relation Ld = 0 evaluates to one if Ld is equal to zero, otherwise it evaluates to zero.

2.2 Instruction Execution

On instruction execution, all bits of the operands participate in the operations, except on the Shift and Rotate instructions (whereat only the 5 least significant bits of the source operand are used) and except on the byte and half word Store instructions.

Instruction pipeline is as follows:

Instructions are executed by a two-stage pipeline. In the first stage, the instruction is fetched from the instruction cache and decoded. In the second stage, the instruction is executed while the next instruction in the first stage is already decoded.

Register instructions are as follows:

On register instructions executing in one or two cycles, the corresponding source and destination operand words are read from their registers and evaluated in each cycle in which they are used. Then the result word is placed in the corresponding destination register in the same cycle. Thus, on all single-word register instructions executing in one cycle, the source operand register and the destination operand register may coincide without changing the effect of the instruction. On all other instructions, the effect of a register coincidence depends on execution order and must be examined specifically for each such instruction.

The content of a source register remains unchanged unless it is used coincidentally as a destination register (except on memory Load instructions).

Conditional flags are changed:

Some instructions set or clear condition flags according to the result and special conditions occurring during their execution. The conditions may be expressed by single bits, relations or logical combinations of these. If a condition evaluates to one (true), the corresponding condition flag is set to one, if it evaluates to zero (false), the corresponding condition flag is cleared to zero. A trap to Range Error may occur if the specific flags and the destination are updated.

All instructions may use the result and any flags updated by the preceding instruction. A time penalty occurs only if the result of a memory Load instruction is not yet available when needed as destination or source operand. In this case one or more (depending on the memory access time) idle wait cycles are enforced by a hardware interlock.

Using local registers are as follows:

An instruction must not use any local register of the register sequence beginning with L0 beyond the number of usable registers specified by the current value of the frame length FL (FL = 0 is interpreted as FL = 16). That is, the value of the corresponding register code (0..15) addressing a local register must be lower than the interpreted value of the FL (except with a Call or Frame instruction or some restricted cases). Otherwise, an exception could overwrite the contents of such a register or the beginning of the register part of the stack at the SP could be overwritten without any warning when a result is placed in such a register.

Double-word instructions denote the high-order word (at the lower address). The low-order word adjacently following it (at the higher address) is implied.

"Old" denotes the state before the execution of an instruction.

2.3 Instruction Formats

Instructions have a length of one, two or three half words and must be located on half word boundaries. The following formats are provided:

Format	Configuration													
LL	<table border="1"> <tr> <td>15</td> <td>8 7</td> <td>4 3</td> <td>0</td> </tr> <tr> <td>OP-code</td> <td>Ld-code</td> <td>Ls-code</td> <td></td> </tr> </table>	15	8 7	4 3	0	OP-code	Ld-code	Ls-code		Ls-code encodes L0..L15 for Ls Ld-code encodes L0..L15 for Ld				
15	8 7	4 3	0											
OP-code	Ld-code	Ls-code												
LLext	<table border="1"> <tr> <td>15</td> <td>8 7</td> <td>4 3</td> <td>0</td> </tr> <tr> <td>OP-code</td> <td>Ld-code</td> <td>Ls-code</td> <td></td> </tr> <tr> <td colspan="4">OP-code extension</td> </tr> </table>	15	8 7	4 3	0	OP-code	Ld-code	Ls-code		OP-code extension				Ls-code encodes L0..L15 for Ls Ld-code encodes L0..L15 for Ld OP-code extension encodes the EXTEND instructions
15	8 7	4 3	0											
OP-code	Ld-code	Ls-code												
OP-code extension														
LR	<table border="1"> <tr> <td>15</td> <td>9 8 7</td> <td>4 3</td> <td>0</td> </tr> <tr> <td>OP-code</td> <td>s</td> <td>Ld-code</td> <td>Rs-code</td> </tr> </table>	15	9 8 7	4 3	0	OP-code	s	Ld-code	Rs-code	s = 0: Rs-code encodes G0..G15 for Rs s = 1: Rs-code encodes L0..L15 for Rs Ld-code encodes L0..L15 for Ld				
15	9 8 7	4 3	0											
OP-code	s	Ld-code	Rs-code											
RR	<table border="1"> <tr> <td>15</td> <td>10 9 8 7</td> <td>4 3</td> <td>0</td> </tr> <tr> <td>OP-Code</td> <td>d s</td> <td>Rd-code</td> <td>Rs-code</td> </tr> </table>	15	10 9 8 7	4 3	0	OP-Code	d s	Rd-code	Rs-code	s = 0: Rs-code encodes G0..G15 for Rs s = 1: Rs-code encodes L0..L15 for Rs d = 0: Rd-code encodes G0..G15 for Rd d = 1: Rd-code encodes L0..L15 for Rd				
15	10 9 8 7	4 3	0											
OP-Code	d s	Rd-code	Rs-code											
Ln	<table border="1"> <tr> <td>15</td> <td>9 8 7</td> <td>4 3</td> <td>0</td> </tr> <tr> <td>OP-code</td> <td>n</td> <td>Ld-code</td> <td>n</td> </tr> </table>	15	9 8 7	4 3	0	OP-code	n	Ld-code	n	Ld-code encodes L0..L15 for Ld n: Bit 8//bits 3..0 encode n = 0..31				
15	9 8 7	4 3	0											
OP-code	n	Ld-code	n											
Rn	<table border="1"> <tr> <td>15</td> <td>10 9 8 7</td> <td>4 3</td> <td>0</td> </tr> <tr> <td>OP-Code</td> <td>d n</td> <td>Rd-code</td> <td>n</td> </tr> </table>	15	10 9 8 7	4 3	0	OP-Code	d n	Rd-code	n	d = 0: Rd-code encodes G0..G15 for Rd d = 1: Rd-code encodes L0..L15 for Rd n: Bit 8//bits 3..0 encode n = 0..31				
15	10 9 8 7	4 3	0											
OP-Code	d n	Rd-code	n											
PCadr	<table border="1"> <tr> <td>15</td> <td>8 7</td> <td>0</td> </tr> <tr> <td>OP-code</td> <td colspan="2">adr-byte</td> </tr> </table>	15	8 7	0	OP-code	adr-byte		adr = 24 ones's//adr-byte(7..2)//00						
15	8 7	0												
OP-code	adr-byte													
PCrel	<table border="1"> <tr> <td>15</td> <td>8 7 6</td> <td>1 0</td> </tr> <tr> <td>OP-code</td> <td>0</td> <td>low-rel</td> <td>S</td> </tr> </table>	15	8 7 6	1 0	OP-code	0	low-rel	S	S: sign bit of rel rel = 25 S//low-rel//0 range -128..126					
15	8 7 6	1 0												
OP-code	0	low-rel	S											
PCrel	<table border="1"> <tr> <td>15</td> <td>8 7 6</td> <td>1 0</td> </tr> <tr> <td>OP-code</td> <td>1</td> <td>high-rel</td> <td></td> </tr> <tr> <td colspan="3">low-rel</td> <td>S</td> </tr> </table>	15	8 7 6	1 0	OP-code	1	high-rel		low-rel			S	S: sign bit of rel rel = 9 S//high-rel//low-rel//0 range -8 388 608..8 388 606	
15	8 7 6	1 0												
OP-code	1	high-rel												
low-rel			S											

Table 2.1: Instruction Formats, Part 1

2.3 Instruction Formats (continued)

Format	Configuration																				
LRconst	<table border="1" style="display: inline-table; vertical-align: top;"> <tr> <td style="text-align: right;">15 14</td> <td style="text-align: right;">9 8 7</td> <td style="text-align: right;">4 3</td> <td style="text-align: right;">0</td> </tr> <tr> <td colspan="2">OP-code</td> <td>s</td> <td>Ld-code</td> </tr> <tr> <td>e</td> <td>S</td> <td colspan="2">const1</td> </tr> <tr> <td colspan="4">const2</td> </tr> </table> <p> s = 0: Rs-code encodes G0..G15 for Rs s = 1: Rs-code encodes L0..L15 for Rs Ld-code encodes L0..L15 for Ld S: Sign bit of const e = 0: const = 18 S//const1 range -16 384..16 383 e = 1: const = 2 S//const1//const2 range -1 073 741 824..1 073 741 82 </p>	15 14	9 8 7	4 3	0	OP-code		s	Ld-code	e	S	const1		const2							
15 14	9 8 7	4 3	0																		
OP-code		s	Ld-code																		
e	S	const1																			
const2																					
RRconst	<table border="1" style="display: inline-table; vertical-align: top;"> <tr> <td style="text-align: right;">15 14</td> <td style="text-align: right;">10 9 8 7</td> <td style="text-align: right;">4 3</td> <td style="text-align: right;">0</td> </tr> <tr> <td colspan="2">OP-code</td> <td>d</td> <td>s</td> </tr> <tr> <td colspan="2"></td> <td>Rd-code</td> <td>Rs-code</td> </tr> <tr> <td>e</td> <td>S</td> <td colspan="2">const1</td> </tr> <tr> <td colspan="4">const2</td> </tr> </table> <p> s = 0: Rs-code encodes G0..G15 for Rs s = 1: Rs-code encodes L0..L15 for Rs d = 0: Rd-code encodes G0..G15 for Rd d = 1: Rd-code encodes L0..L15 for Rd S: Sign bit of const e = 0: const = 18 S//const 1 range -16 384..16 383 e = 1: const = 2 S//const1//const2 range -1 073 741 824..1 073 741 82 </p>	15 14	10 9 8 7	4 3	0	OP-code		d	s			Rd-code	Rs-code	e	S	const1		const2			
15 14	10 9 8 7	4 3	0																		
OP-code		d	s																		
		Rd-code	Rs-code																		
e	S	const1																			
const2																					
RRdis	<table border="1" style="display: inline-table; vertical-align: top;"> <tr> <td style="text-align: right;">15 14</td> <td style="text-align: right;">10 9 8 7</td> <td style="text-align: right;">4 3</td> <td style="text-align: right;">0</td> </tr> <tr> <td colspan="2">OP-code</td> <td>d</td> <td>s</td> </tr> <tr> <td colspan="2"></td> <td>Rd-code</td> <td>Rs-code</td> </tr> <tr> <td>e</td> <td>S</td> <td>DD</td> <td>dis1</td> </tr> <tr> <td colspan="4">dis2</td> </tr> </table> <p> s = 0: Rs-code encodes G0..G15 for Rs s = 1: Rs-code encodes L0..L15 for Rs d = 0: Rd-code encodes G0..G15 for Rd d = 1: Rd-code encodes L0..L15 for Rd S: Sign bit of dis e = 0: dis = 20 S//dis1 range -4 096..4 095 e = 1: dis = 4 S//dis1//dis2 range -268 435 456..268 435 455 DD: D-code, D13..D12 encode data types at memory instructions </p>	15 14	10 9 8 7	4 3	0	OP-code		d	s			Rd-code	Rs-code	e	S	DD	dis1	dis2			
15 14	10 9 8 7	4 3	0																		
OP-code		d	s																		
		Rd-code	Rs-code																		
e	S	DD	dis1																		
dis2																					
Rimm	<table border="1" style="display: inline-table; vertical-align: top;"> <tr> <td style="text-align: right;">15</td> <td style="text-align: right;">10 9 8 7</td> <td style="text-align: right;">4 3</td> <td style="text-align: right;">0</td> </tr> <tr> <td colspan="2">OP-code</td> <td>d</td> <td>n</td> </tr> <tr> <td colspan="2"></td> <td>Rd-code</td> <td>n</td> </tr> <tr> <td colspan="4">imm1</td> </tr> <tr> <td colspan="4">imm2</td> </tr> </table> <p> d = 0: Rd-code encodes G0..G15 for Rd d = 1: Rd-code encodes L0..L15 for Rd n: Bit 8//bits 3..0 encode n = 0..31 see Table 2.3. Encoding of Immediate Values for encoding of imm </p>	15	10 9 8 7	4 3	0	OP-code		d	n			Rd-code	n	imm1				imm2			
15	10 9 8 7	4 3	0																		
OP-code		d	n																		
		Rd-code	n																		
imm1																					
imm2																					
RRlim	<table border="1" style="display: inline-table; vertical-align: top;"> <tr> <td style="text-align: right;">15 14</td> <td style="text-align: right;">10 9 8 7</td> <td style="text-align: right;">4 3</td> <td style="text-align: right;">0</td> </tr> <tr> <td colspan="2">OP-code</td> <td>d</td> <td>s</td> </tr> <tr> <td colspan="2"></td> <td>Rd-code</td> <td>Rs-code</td> </tr> <tr> <td>e</td> <td>XXX</td> <td colspan="2">lim1</td> </tr> <tr> <td colspan="4">lim2</td> </tr> </table> <p> s = 0: Rs-code encodes G0..G15 for Rs s = 1: Rs-code encodes L0..L15 for Rs d = 0: Rd-code encodes G0..G15 for Rd d = 1: Rd-code encodes L0..L15 for Rd XXX: X-code, X14..X12 encode Index instructions e = 0: lim = 20 zeros//lim1 range 0..4 095 e = 1: lim = 4 zeros//lim1//lim2 range 0..268 435 455 </p>	15 14	10 9 8 7	4 3	0	OP-code		d	s			Rd-code	Rs-code	e	XXX	lim1		lim2			
15 14	10 9 8 7	4 3	0																		
OP-code		d	s																		
		Rd-code	Rs-code																		
e	XXX	lim1																			
lim2																					

Table 2.2: Instruction Formats, Part 2

2.3.1 Table of Immediate Values

n	immediate value imm	Comment
0..16	0..16	at CMPBI, n = 0 encodes ANYBZ at ADDI and ADDSI n = 0 encodes CZ
17	imm1//imm2	range = $0..2^{32}-1$ or $-2^{31}..2^{31}-1$
18	16 zeros//imm1	range = 0..65 535
19	16 ones//imm1	range = -65 536..-1
20	32	bit 5 = 1, all other bits = 0
21	64	bit 6 = 1, all other bits = 0
22	128	bit 7 = 1, all other bits = 0
23	2^{31}	bit 31 = 1, all other bits = 0
24	-8	
25	-7	
26	-6	
27	-5	
28	-4	
29	-3	
30	-2	
31	$2^{31}-1$	at CMPBI and ANDNI bit 31 = 0, all other bits = 1
31	-1	at all other instructions using imm

Table 2.3: Encoding of Immediate Values

Note: 2^{31} provides clear, set and invert of the floating-point sign bit at ANDNI, ORI and XORI respectively.

$2^{31}-1$ provides a test for floating-point zero at CMPBI and extraction of the sign bit at ANDNI.

See CMPBI for ANYBZ and ADDI, ADDSI for CZ.

2.3.2 Table of Instruction Codes

		OP-code Bits 11..8																					
		OP-code Bits 15..12																					
A	B	C	D	E	F	0	1	2	3	4	5	6	7	8	9	10	11	12	13	14	15		
						CHK, CHKZ, NOP					MOVD, RET											DIVS	
						XMx, XMxZ					MASK												
						CMP					MOV												
											ANDN												XOR
																							SUBS
											AND												
						CMPI					MOVI												ADDSI
						CMPBI					ANDNI												
						SHRDI			SHR	SARDI			SAR										ROL
						LDxx.D/A/IOD/IOA					LDxx.N/S												STxx.N/S
						SHRI																	
						FADD	FADDD		FSUBD		FMUL		FDIV	FDIVD		FCMPD		FCMPUD		FCVT	FCVTD	EXTEND	DO
						LDW.R			LDD.R							STW.R		STD.R		STW.P		STD.P	
						DBV	DBNV	DBE		DBC	DBNC				DBN	DBNN	DBLE		DBR	FRAME		CALL	
						BNV	BE	BNE		BC		BSE	BHT		BNN	BLE	BGT					TRAPxx, TRAP	

Table 2.4: Table of Instruction Codes

2.3.3 Table of Extended DSP Instruction Codes

The Extended DSP instructions are specified by a 16-bit OP-code extension succeeding the instruction op-code for the EXTEND instruction. See section [3.32. Extended DSP Instructions](#).

Instruction	OP-code extension (hex)
EMUL	0100
EMULU	0104
EMULS	0106
EMAC	010A
EMACD	010E
EMSUB	011A
EMSUBD	011E
EHMAC	002A
EHMACD	002E
EHCMULD	0046
EHCMACD	004E
EHCSUMD	0086
EHCFSTD	0096

Table 2.5: Extended DSP Instruction Codes

2.4 Entry Tables

Spacing of the entries for the Trap instructions and exceptions is four bytes. These entries are intended to each contain an instruction branching to the associated function. The entries for the TRAP_{xx} instructions are the same as for TRAP. Table 2.6 shows the trap entries when the entry table is mapped to the end of memory area MEM3 (default after Reset):

Address (Hex)	Entry	Description
FFFF FF00	TRAP 0	
FFFF FF04	TRAP 1	
:	:	
FFFF FFC0	TRAP 48	IO2 Interrupt -- priority 15
FFFF FFC4	TRAP 49	IO1 Interrupt -- priority 14
FFFF FFC8	TRAP 50	INT4 Interrupt -- priority 13
FFFF FFCC	TRAP 51	INT3 Interrupt -- priority 11
FFFF FFD0	TRAP 52	INT2 Interrupt -- priority 9
FFFF FFD4	TRAP 53	INT1 Interrupt -- priority 7
FFFF FFD8	TRAP 54	IO3 Interrupt -- priority 5
FFFF FFDC	TRAP 55	Timer Interrupt -- priority selectable as 6, 8, 10, 12
FFFF FFE0	TRAP 56	Reserved -- priority 17 (lowest)
FFFF FFE4	TRAP 57	Trace Exception -- priority 16
FFFF FFE8	TRAP 58	Parity Error -- priority 4
FFFF FFEC	TRAP 59	Extended Overflow -- priority 3
FFFF FFF0	TRAP 60	Range, Pointer, Frame and Privilege Error -- priority 2
FFFF FFF4	TRAP 61	Reserved -- priority 1
FFFF FFF8	TRAP 62	Reset -- priority 0 (highest)
FFFF FFFC	TRAP 63	Error entry for instruction code of all ones

Table 2.6: Trap entry table mapped to the end of MEM3

2.4 Entry Tables (continued)

Table 2.7 shows the trap entries when the entry table is mapped to the beginning of memory areas MEM0, MEM1, MEM2 or IRAM. x is 0, 4, 8 or C corresponding to the mapping to MEM0, MEM1, MEM2 or IRAM respectively.

Address (Hex)	Entry	Description
x000 0000	TRAP 63	Error entry for instruction code of all ones
x000 0004	TRAP 62	Reserved -- priority 0 (highest)
x000 0008	TRAP 61	Reserved -- priority 1
x000 000C	TRAP 60	Range, Pointer, Frame and Privilege Error -- priority 2
x000 0010	TRAP 59	Extended Overflow -- priority 3
x000 0014	TRAP 58	Parity Error -- priority 4
x000 0018	TRAP 57	Trace Exception -- priority 16
x000 001C	TRAP 56	Reserved -- priority 17 (lowest)
x000 0020	TRAP 55	Timer Interrupt -- priority selectable as 6, 8, 10, 12
x000 0024	TRAP 54	IO3 Interrupt -- priority 5
x000 0028	TRAP 53	INT1 Interrupt -- priority 7
x000 002C	TRAP 52	INT2 Interrupt -- priority 9
x000 0030	TRAP 51	INT3 Interrupt -- priority 11
x000 0034	TRAP 50	INT4 Interrupt -- priority 13
x000 0038	TRAP 49	IO1 Interrupt -- priority 14
x000 003C	TRAP 48	IO2 Interrupt -- priority 15
:	:	
x000 00F8	TRAP 1	
x000 00FC	TRAP 0	

Table 2.7: Trap entry table mapped to the beginning of MEM0, MEM1, MEM2 or IRAM

2.4 Entry Tables (continued)

Table 2.8 below shows the addresses of the first instruction of the emulator code associated with the floating-point instructions when the trap entry tables are mapped to the end of memory area MEM3. Spacing of the entries for the Software instructions FADD..DO is 16 bytes.

Address (Hex)	Entry	Description
FFFF FE00	FADD	Floating-point Add, single word
FFFF FE10	FADDD	Floating-point Add, double-word
FFFF FE20	FSUB	Floating-point Subtract, single word
FFFF FE30	FSUBD	Floating-point Subtract, double-word
FFFF FE40	FMUL	Floating-point Multiply, single word
FFFF FE50	FMULD	Floating-point Multiply, double-word
FFFF FE60	FDIV	Floating-point Divide, single word
FFFF FE70	FDIVD	Floating-point Divide, double-word
FFFF FE80	FCMP	Floating-point Compare, single word
FFFF FE90	FCMPD	Floating-point Compare, double-word
FFFF FEA0	FCMPU	Floating-point Compare Unordered, single word
FFFF FEB0	FCMPUD	Floating-point Compare Unordered, double-word
FFFF FEC0	FCVT	Floating-point Convert single word \Rightarrow double-word
FFFF FED0	FCVTD	Floating-point Convert double-word \Rightarrow single word
FFFF FEE0		Reserved
FFFF FEF0	DO	Do instruction

Table 2.8: Floating-Point entry table mapped to the end of MEM3

2.4 Entry Tables (continued)

Table 2.9 below shows the addresses of the first instruction of the emulator code associated with the floating-point instructions when the trap entry tables are mapped to the beginning of memory areas MEM0, MEM1, MEM2 or IRAM. x is 0, 4, 8 or C corresponding to the mapping to MEM0, MEM1, MEM2 or IRAM respectively.

Address (Hex)	Entry	Description
x000 010C	DO	Do instruction
x000 011C		Reserved
x000 012C	FCVTD	Floating-point Convert double-word \Rightarrow single word
x000 013C	FCVT	Floating-point Convert single word \Rightarrow double-word
x000 014C	FCMPUD	Floating-point Compare Unordered, double-word
x000 015C	FCMPU	Floating-point Compare Unordered, single word
x000 016C	FCMPD	Floating-point Compare, double-word
x000 017C	FCMP	Floating-point Compare, single word
x000 018C	FDIVD	Floating-point Divide, double-word
x000 019C	FDIV	Floating-point Divide, single word
x000 01AC	FMULD	Floating-point Multiply, double-word
x000 01BC	FMUL	Floating-point Multiply, single word
x000 01CC	FSUBD	Floating-point Subtract, double-word
x000 01DC	FSUB	Floating-point Subtract, single word
x000 01EC	FADDD	Floating-point Add, double-word
x000 01FC	FADD	Floating-point Add, single word

Table 2.9: Floating-Point entry table mapped to the beginning of MEM0, MEM1, MEM2 or IRAM

2.5 Instruction Timing

The following execution times are given in number of processor clock cycles.

All instructions not shown below: 1 cycle

Move Double-Word: 2 cycles

Shift Double-Word: 2 cycles

Test Leading Zeros: 2 cycles

Multiply word:

when both operands are in the range of $-2^{15}..2^{15}-1$: 4 cycles

all other cases: 5 cycles

Multiply double-word signed:

when both operands are in the range of $-2^{15}..2^{15}-1$: 5 cycles

all other cases: 6 cycles

Multiply double-word unsigned:

when both operands are in the range of $0..2^{16}-1$: 4 cycles

all other cases: 6 cycles

Divide unsigned and signed: 36 cycles

Branch instructions when branch not taken: 1 cycle

when branch taken and target in on-chip cache: 2 cycles

when branch taken and target in memory : 2 + memory read latency cycles

(see next page)

Delayed Branch instructions when branch not taken: 1 cycle

when branch taken and target in on-chip cache: 1 cycle

when branch taken and target in memory: 1 + memory read latency cycles exceeding
(delay instruction cycles - 1)

Call and Trap instructions when branch not taken: 1 cycle

when branch taken: 2 + memory read latency cycles

Software instructions: 6 + memory read latency cycles exceeding 4 cycles

Frame when not pushing words on the stack: 3 cycles

additionally when pushing n words on the stack: memory write latency cycles

+ n * bus cycles per access

-- write latency = cycles elapsed until write access cycle of first word stored
(minimum = 1 at a non-RAS access and no pipeline congestion)

Return:

4 + memory read latency cycles exceeding 2 cycles

additionally when pulling n words from the stack: memory RAS latency

+ n * bus cycles per access

(RAS latency applies only at $n > 2$, otherwise RAS latency is always 0)

-- RAS latency = RAS precharge cycles + RAS to CAS delay cycles

2.5 Instruction Timing (continued)

Fetch instruction:

when the required number of instruction half words are already prefetched in the instruction cache: 1 cycle

otherwise

$1 + (\text{required number of half words} - \text{number of half words already prefetched})/2$

* bus cycles per access

Memory word instructions, non-stack address mode:

1 cycle

Memory word instructions, stack address mode:

3 cycles

Memory double-word instructions:

2 cycles

For timing calculations, double-word memory instructions are treated like a sequence of two single-word memory instructions.

Idle wait cycles are transparently inserted when a memory instruction has to wait for execution because the two-stage address pipeline is full.

Instruction execution proceeds after the execution of a Load instruction until the data requested is needed (that is, the register into which the data is to be loaded is addressed) by a further instruction.

The cycles executed between the memory instruction cycle requesting the data and the first cycle at which the data are available are called *read latency cycles*. These read latency cycles can be filled with instructions that do not need the requested data. When, after the execution of these optional fill instruction cycles, the data is still not available in the cycle needing it, idle wait cycles are inserted until the data is available. The idle wait cycles are inserted transparently to the program by an on-chip hardware interlock. The read latency is:

On an IRAM access:

read latency = 1 cycle

On a non-RAS external memory or I/O access:

read latency = address setup cycles + access cycles + 1

On a RAS memory access:

read latency = RAS precharge cycles + RAS to CAS delay cycles +
access cycles + 1

Additional cycles are also inserted and add to the latency when the address pipeline is congested, these cycles must then also be taken into calculation.

A switch from an external memory or I/O read access to an immediately succeeding write access inserts one additional bus cycle.

2.5 Instruction Timing (continued)

Extended DSP instructions:

The instruction issue time is always 1 cycle. After the issue of an Extended DSP instruction, execution of non-Extended-DSP instructions proceeds while the Extended DSP instruction is executed in the multiply/accumulate unit (using separate resources). Latency cycles are defined as the interval between instruction issue and the result being available in the register G15 or register pair G14//G15. The latency cycles indicate as well the number of cycles available for instructions not using the result which can be inserted between the Extended DSP instruction and the first instruction using the result. When less than the number of latency cycles are used by these instructions, the execution of the instruction using the result is delayed until the result is available in G15 or G14//G15.

When an Extended DSP instruction which uses the internal hardware multiplier (EMUL, ..., EHCMA CD) succeeds an Extended DSP instruction which also uses the internal hardware multiplier after less than latency - 1 cycles, the issue of the succeeding Extended DSP instruction is delayed until latency - 1 cycles are finished. An Extended DSP instruction succeeding the EHCSUMD or EHCFFTD instruction after less than the latency cycles for these two instructions is always delayed until the EHCSUMD or EHCFFTD instruction is finished.

The latency cycles are as follows:

EMUL instruction:

when both operands are in the range of $-2^{15}..2^{15}-1$: 1 cycle
all other cases: 3 cycles

EMULU instruction:

when both operands are in the range of $0..2^{16}-1$: 2 cycles
all other cases: 4 cycles

EMULS instruction:

when both operands are in the range of $-2^{15}..2^{15}-1$: 3 cycles
all other cases: 4 cycles

EMAC instruction:

when both operands are in the range of $-2^{15}..2^{15}-1$: 2 cycles
all other cases: 3 cycles

EMACD instruction:

when both operands are in the range of $-2^{15}..2^{15}-1$: 3 cycles
all other cases: 4 cycles

EMSUB instruction:

when both operands are in the range of $-2^{15}..2^{15}-1$: 2 cycles
all other cases: 3 cycles

EMSUBD instruction:

when both operands are in the range of $-2^{15}..2^{15}-1$: 3 cycles
all other cases: 4 cycles

EHM MAC instruction: 2 cycles

EHM MACD instruction: 4 cycles

2.5 Instruction Timing (continued)

EHCMULD instruction: 4 cycles

EHCMACD instruction: 4 cycles

EHCSUMD instruction: 2 cycles

EHCFFTD instruction: 2 cycles

3. Instruction Set

3.1 Memory Instructions

The memory instructions load data from memory in a register R_s (or a register pair $R_s//R_{sf}$) or store data from R_s (or $R_s//R_{sf}$) to memory using the data types byte unsigned/signed, half word unsigned/signed, word or double-word. Since I/O devices are also addressed by memory instructions, "memory" stands here interchangeably also for I/O unless memory or I/O address space is specifically denoted.

The memory address is either specified by the operand R_d or L_d , by the sum R_d plus a signed displacement or by the displacement alone, depending on the address mode. Memory accesses to words and double-words ignore bits one and zero of the address, memory accesses to half words ignore bit zero of the address, (since these operands are located at word or half word boundaries respectively, these address bits are redundant).

If the content of any register R_d except SR is zero, the memory is not accessed and a trap to Pointer Error occurs (see [section 4. Exceptions](#)). Thus, uninitialized pointers are automatically checked.

Load and Store instructions are pipelined to a total depth of two word entries for Load and Store, thus, a double-word Load or a double-word Store instruction can be executed without halting the processor in a wait state. (The address pipeline provides a depth of two addresses common to load and store).

Double-word memory instructions enter two separate word entries into the pipeline and start two independent memory cycles. The first memory cycle, loading or storing the high-order word, uses the address specified by the address mode, the second cycle uses this address incremented by four and also places it on the address bus.

Accessing data in the same DRAM memory page by any number of succeeding memory cycles is performed in page mode.

Memory instructions leave all condition flags unchanged.

3.1.1 Address Modes

Register Address Mode:

Notation: $LD_{xx}.R$, $ST_{xx}.R$ -- xx : word or double word data type

The content of the destination register Ld is used as an address into memory address space.

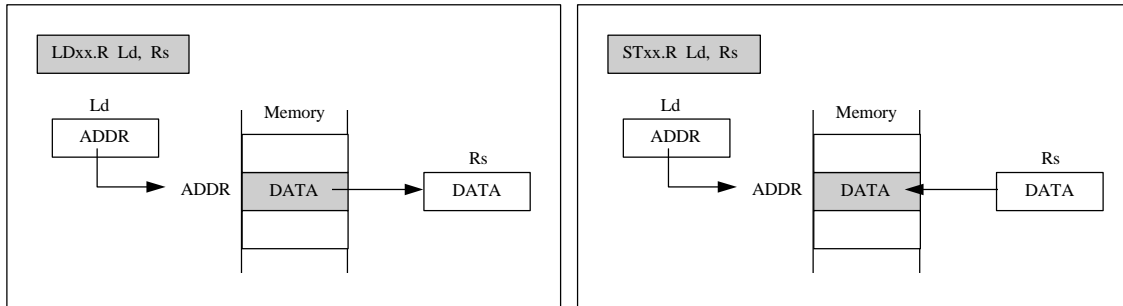

Post-increment Address Mode:

Notation: $LD_{xx}.P$, $ST_{xx}.P$ -- xx : word or double-word data type

The content of the destination register Ld is used as an address into memory address space, then Ld is incremented according to the specified data size of a word or double-word memory instruction by 4 or 8 respectively, regardless of any exception occurring. In the case of a double-word data type, Ld is incremented by 8 at the first memory cycle.

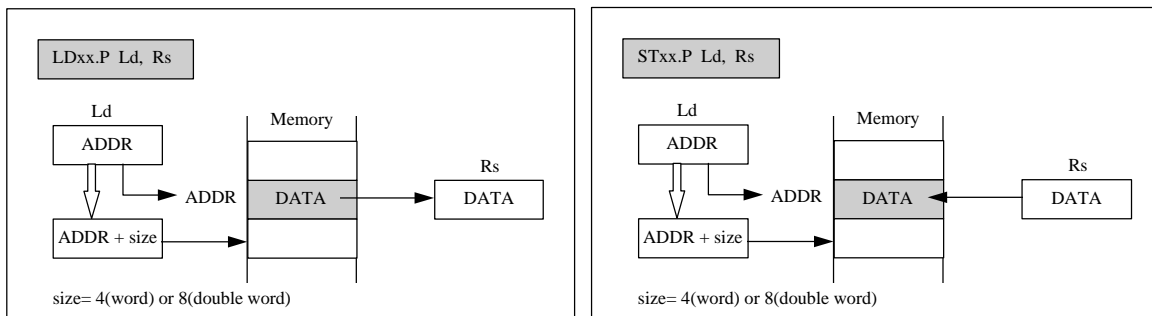

Displacement Address Mode:

Notation: $LD_{xx}.D$, $ST_{xx}.D$ -- xx : any data type

The sum of the contents of the destination register Rd plus a signed displacement dis is used as an address into memory address space.

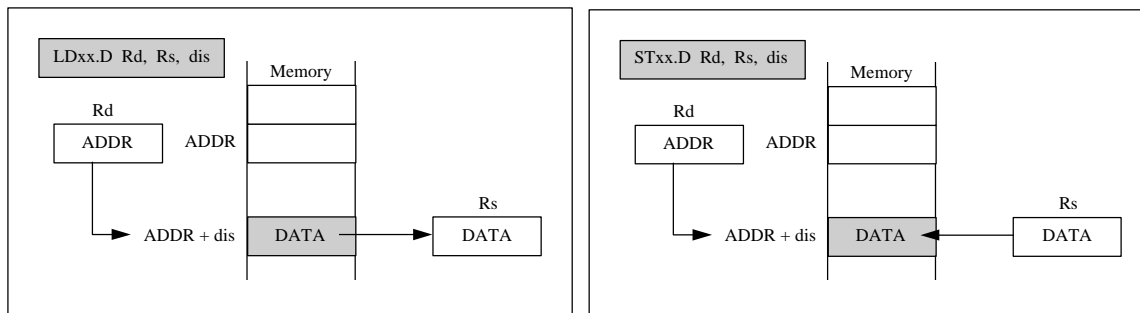

Rd may denote any register except the SR; Rd not denoting the SR differentiates this mode

from the absolute address mode.

In the case of all data types except byte, bit zero of *dis* is treated as zero for the calculation of $Rd + dis$.

Note: Specification of the PC for Rd provides addressing relative to the address of the first byte after the memory instruction.

Absolute Address Mode:

Notation: $LD_{xx}.A$, $ST_{xx}.A$ -- *xx*: any data type

The displacement *dis* is used as an address into memory address space. Rd must denote the SR to differentiate this mode from the displacement address mode; the content of the SR is not used.

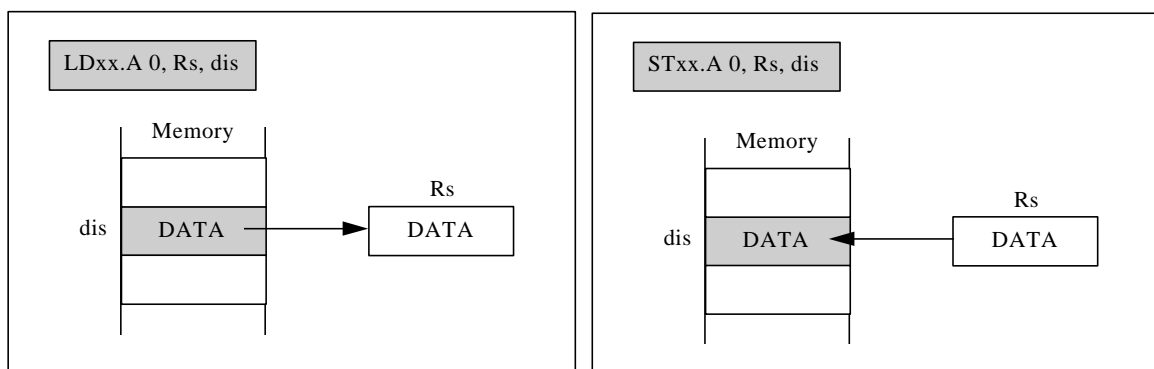

In the case of all data types except byte, address bit zero is supplied as zero.

Note: The displacement provides absolute addressing at the beginning and the end (MEM3 area) of the memory.

I/O Displacement Address Mode:

Notation: $LD_{xx}.IOD$, $ST_{xx}.IOD$ -- *xx*: word or double-word data type

The sum of the contents of the destination register Rd plus a signed displacement *dis* is used as an address into I/O address space.

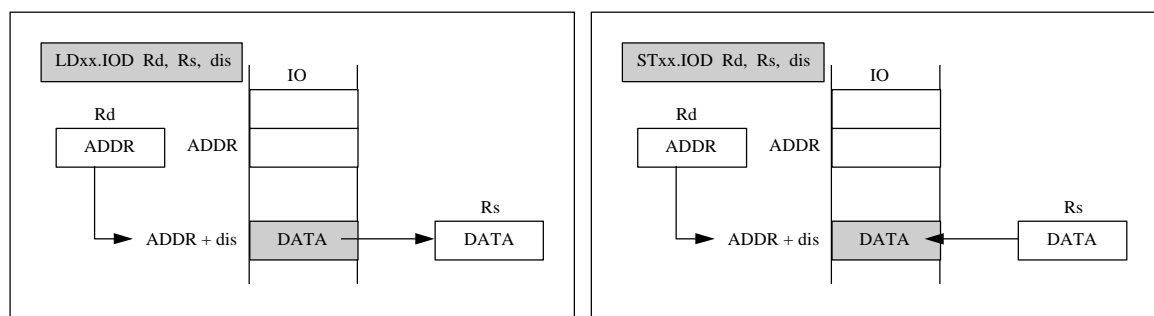

Rd may denote any register except the SR; Rd not denoting the SR differentiates this mode from the I/O absolute address mode.

Bits one and zero of *dis* are treated as zero for the calculation of $Rd + dis$.

Execution of a memory instruction with I/O displacement address mode does not disrupt any page mode sequence.

Note: The I/O displacement address mode provides dynamic addressing of peripheral devices.

When on a load instruction only a byte or half word is placed on the (lower part) of the data bus, the higher-order bits are undefined and must be masked out before the loaded operand is used further.

I/O Absolute Address Mode:

Notation: $LD_{xx}.IOA$, $ST_{xx}.IOA$ -- xx: word or double-word data type

The displacement *dis* is used as an address into I/O address space.

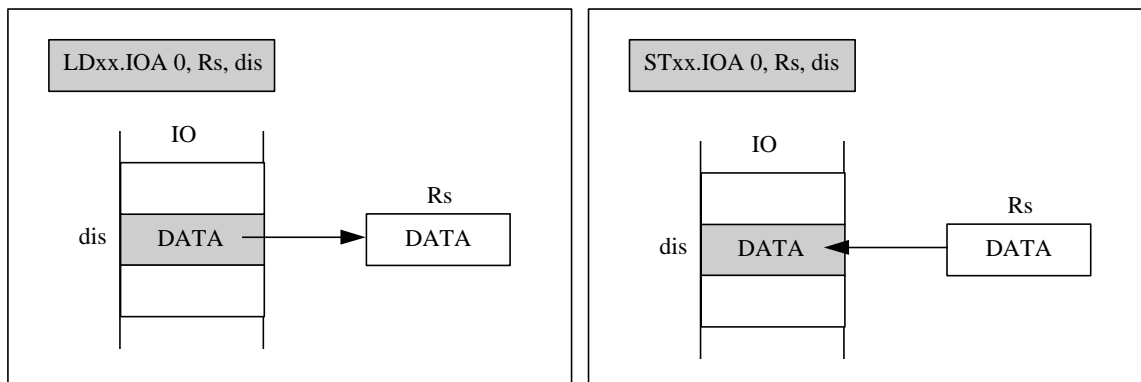

Rd must denote the SR to differentiate this mode from the I/O displacement address mode; the content of the SR is not used.

Address bits one and zero are supplied as zero.

Execution of a memory instruction with I/O address mode does not disrupt any page mode sequence.

Note: The I/O absolute address mode provides code efficient absolute addressing of peripheral devices and allows simple decoding of I/O addresses.

When on a load instruction only a byte or a half word is placed on the (lower part) of the data bus, the higher-order bits are undefined and must be masked out before the loaded operand is used further.

Next Address Mode:

Notation: $LD_{xx}.N$, $ST_{xx}.N$ -- xx: any data type

The content of the destination register Rd is used as an address into memory address space, then Rd is incremented by the signed displacement *dis* regardless of any exception occurring. At a double-word data type, Rd is incremented at the first memory cycle.

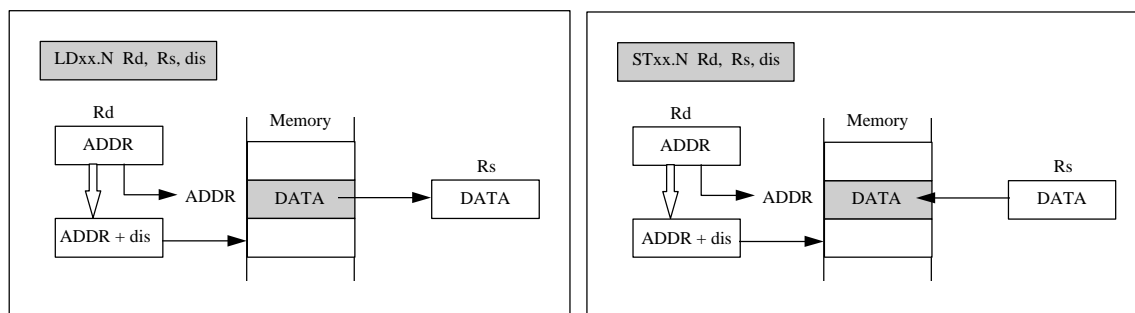

Rd must not denote the PC or the SR.

In the case of all data types except byte, bit zero of dis is treated as zero for the calculation of $Rd + dis$.

Stack Address Mode:

Notation: `LDW.S`, `STW.S` -- only word data type

The content of the destination register Rd is used as stack address, then Rd is incremented by dis regardless of any exception occurred.

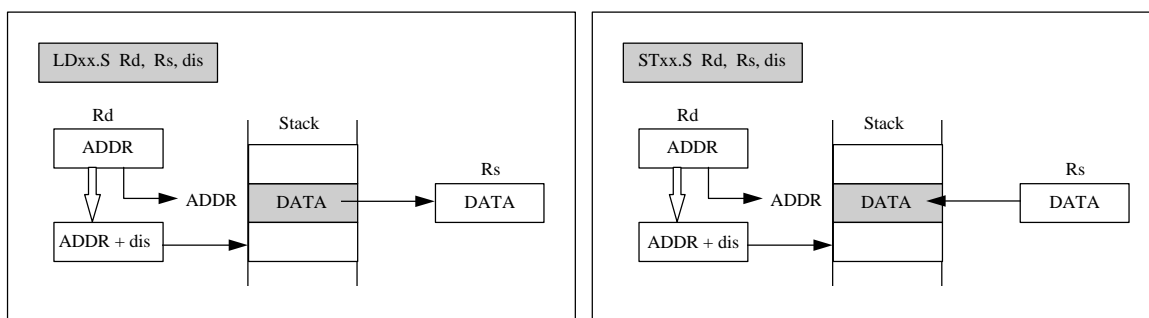

A stack address addresses memory address space if it is lower than the stack pointer SP; otherwise bits 7..2 of it (higher bits are ignored) address a register in the register part of the stack absolutely (not relative to the frame pointer FP).

Bits one and zero of dis are treated as zero for the calculation of $Rd + dis$.

Rd must not denote the PC or the SR.

Note: The stack address mode must be used to address an operand in the stack regardless of its present location either in the memory part or in the register part of the stack. Rd may be set by the Set Stack Address instruction.

Address Mode Encoding:

The encoding of the displacement and absolute address mode types of memory instructions is shown in table 3.1:

D-code	dis(1)	dis(0)	LDxx.D/A/IOD/IOA		STxx.D/A/IOD/IOA	
			Rd does not denote SR	Rd denotes SR	Rd does not denote SR	Rd denotes SR
0	X	X	LDBS.D	LDBS.A	STBS.D	STBS.A
1	X	X	LDBU.D	LDBU.A	STBU.D	STBU.A
2	X	0	LDHU.D	LDHU.A	STHU.D	STHU.A
2	X	1	LDHS.D	LDHS.A	STHS.D	STHS.A
3	0	0	LDW.D	LDW.A	STW.D	STW.A
3	0	1	LDD.D	LDD.A	STD.D	STD.A
3	1	0	LDW.IOD	LDW.IOA	STW.IOD	STW.IOA
3	1	1	LDD.IOD	LDD.IOA	STD.IOD	STD.IOA

Table 3.1: Encoding of Displacement and Absolute Address Mode

The encoding of the next and stack address mode types of memory instructions is shown in table 3.2:

D-code	dis(1)	dis(0)	With the instructions below, Rd must not denote the PC or the SR	
			LDxx.N/S	STxx.N/S
0	X	X	LDBS.N	STBS.N
1	X	X	LDBU.N	STBU.N
2	X	0	LDHU.N	STHU.N
2	X	1	LDHS.N	STHS.N
3	0	0	LDW.N	STW.N
3	0	1	LDD.N	STD.N
3	1	0	Reserved	Reserved
3	1	1	LDW.S	STW.S

Table 3.2: Encoding of Next and Stack Address Mode

3.1.2 Load Instructions

The Load instructions transfer data from the addressed memory location into a register Rs or a register pair Rs//Rsf.

In the case of data types word and double-word, one or two words are read from memory and transferred unchanged into Rs or Rs//Rsf respectively.

In the case of byte and half word data types, up to one word (depending on bus size) is read from memory, the byte or half word addressed by bits one and zero or bit one of the memory address respectively is extracted, right adjusted, expanded to 32 bits and placed in Rs. Unsigned bytes and half words are expanded by leading zeros; signed bytes and half words are expanded by leading sign bits.

Execution of a Load instruction enters the register address of Rs, memory address bits one and zero and a code for the data type into the load pipeline, places the memory address onto the address bus and starts a memory cycle. A double-word Load instruction enters the register address of Rsf and the same control information into the load pipeline as a second entry, places the memory address incremented by four onto the address bus and starts a second memory cycle.

After execution of a Load instruction, the next instructions are executed without waiting for the data to be loaded. A wait is enforced only if an instruction uses a register whose register address is still in the load pipeline. The data read from memory is placed in the register whose register address is at the head of the load pipeline, its pipeline entry is then deleted.

At memory load instruction Rs denotes the load destination register to load data from memory, IO or stack and Rd denotes the load source register.

Rs must not denote the PC, the SR, G14 or G15; these registers cannot be loaded from memory.

Format	Notation	Operation	Data Type xx
LR	LDxx.R Ld, Rs	Rs := Ld [^] ; [Rsf := (Ld + 4) [^]]; -- register address mode	W,D
LR	LDxx.P Ld, Rs	Rs := Ld [^] ; Ld := Ld + size; -- size = 4 or 8 [Rsf := (old Ld + 4) [^]]; -- post-increment address mode	W,D
RRdis	LDxx.D Rd, Rs, dis	Rs := (Rd + dis) [^] ; [Rsf := (Rd + dis + 4) [^]]; -- displacement address mode	BU,BS,HU,HS,W,D
RRdis	LDxx.A 0, Rs, dis	Rs := dis [^] ; [Rsf := (dis + 4) [^]]; -- absolute address mode	BU,BS,HU,HS,W,D
RRdis	LDxx.IOD Rd, Rs, dis	Rs := (Rd + dis) [^] ; [Rsf := (Rd + dis + 4) [^]]; -- I/O displacement address mode	W,D
RRdis	LDxx.IOA 0, Rs, dis	Rs := dis [^] ; [Rsf := (dis + 4) [^]]; -- I/O absolute address mode	W,D

RRdis	LDxx.N	Rd, Rs, dis	Rs := Rd [^] ; Rd := Rd + dis; [Rsf := (old Rd + 4) [^] ; -- next address mode	BU,BS,HU,HS,W,D
RRdis	LDxx.S	Rd, Rs, dis	Rs := Rd [^] ; Rd := Rd + dis; -- stack address mode	W

The expressions in brackets are only executed at double-word data types.

Data Type xx is with:

BU: byte unsigned;	HU: half word unsigned;	W: word;
BS: byte signed;	HS: half word signed;	D: double-word;

Register

L0 : \$00001E30

L6 : \$0000FFFF

L7 : \$FFFF0000

Memory

00001E30 : 00000F00

00001E34 : 00003F01

00001E38 : 00004C10

00001E3C : 000000FF

Instruction : Register address mode

<i>LDW.R L0, L6</i>	; L6 <= L0 [^] = Address 00001E30 : \$00000F00
<i>LDD.R L0, L6</i>	; L6 <= L0 [^] = Address 00001E30 : \$00000F00 ; L7 <= (L0 + 4) [^] = Address 00001E34 : \$00003F01

Instruction : Displacement address mode

<i>LDW.D L0, L6, \$8</i>	; L6 = (L0 + 8) [^] = Address 00001E38 : \$00004C10
---------------------------------	--

<i>LDD.D L0, L6, \$8</i>	; L6 = (L0 + 8) [^] = Address 00001E38 : \$00004C10
---------------------------------	--

	; L7 = (L0 + 8 + 4) [^] = Address 00001E3C : \$000000FF
--	--

3.1.3 Store Instructions

The Store instructions transfer data from the register Rs or the register pair Rs//Rsf to the addressed memory location.

In the case of data types word or double-word, one or two words are placed unchanged from Rs or Rs//Rsf respectively onto the data bus to be stored in the memory.

In the case of byte and half word data types, the low-order byte or half word is placed onto the data bus at the byte or half word position addressed by bits one and zero or bit one of the memory address respectively; it is implied to be merged (via byte write enable) with the other data in the same memory word.

In the case of signed byte and signed half word data types, any content of Rs exceeding the value range of the specified data type causes a trap to Range Error. The byte or half word is stored regardless of a Range Error.

If Rs denotes the SR, zero is stored regardless of the content of SR (or of SR//G2 at double-word).

Execution of a Store instruction enters the contents of Rs, memory address bits one and zero and a code for the data type into the store pipeline, places the memory address onto the address bus and starts a memory cycle. A double-word Store instruction enters the contents of Rsf and the same control information into the store pipeline as a second entry, places the memory address incremented by four onto the address bus and starts a second memory cycle.

After execution of a Store instruction, the next instructions are executed without waiting for the store memory cycle to finish. The data at the head of the store pipeline is put on the data bus on demand from the on-chip memory control logic and its pipeline entry is deleted.

When Rsf denotes the same register as Rd (or Ld) at double-word instructions with next address or post-increment address mode, the incremented content of Rsf is stored in the second memory cycle; in all other cases, the unchanged content of Rs or Rsf is stored.

Format	Notation	Operation	Data Type xx
LR	STxx.R Ld, Rs	$Ld^{\wedge} := Rs;$ $[(Ld + 4)^{\wedge} := Rsf;]$ -- register address mode	W,D
LR	STxx.P Ld, Rs	$Ld^{\wedge} := Rs; Ld := Ld + size;$ -- size = 4 or 8 $[(old\ Ld + 4)^{\wedge} := Rsf;]$ -- post-increment address mode	W,D
RRdis	STxx.D Rd, Rs, dis	$(Rd + dis)^{\wedge} := Rs;$ $[(Rd + dis + 4)^{\wedge} := Rsf;]$ -- displacement address mode	BU,BS,HU,HS,W,D
RRdis	STxx.A 0, Rs, dis	$dis^{\wedge} := Rs;$ $[(dis + 4)^{\wedge} := Rsf;]$ -- absolute address mode	BU,BS,HU,HS,W,D
RRdis	STxx.IOD Rd, Rs, dis	$(Rd + dis)^{\wedge} := Rs;$ $[(Rd + dis + 4)^{\wedge} := Rsf;]$ -- I/O displacement address mode	W,D

RRdis	STxx.IOA	0, Rs, dis	dis [^] := Rs; [(dis + 4) [^] := Rsf;] -- I/O absolute address mode	W,D
RRdis	STxx.N	Rd, Rs, dis	Rd [^] := Rs; Rd := Rd + dis; [(old Rd + 4) [^] := Rsf;] -- next address mode	BU,BS,HU,HS,W,D
RRdis	STxx.S	Rd, Rs, dis	Rd [^] := Rs; Rd := Rd + dis; -- stack address mode	W

The expressions in brackets are only executed at double-word data types.

In the case of signed byte and half word data types, a trap to Range Error occurs when the value of the operand to be stored exceeds the value range of the specified data type; the byte or half word is stored regardless of a Range Error.

Data Type xx is with:

BU: byte unsigned;	HU: half word unsigned;	W: word;
BS: byte signed;	HS: half word signed;	D: double-word;

Register

L0 : \$00001E30

L6 : \$0000FFFF

L7 : \$FFFF0000

Memory

00001E30 : 00000F00

00001E34 : 00003F01

00001E38 : 00004C10

00001E3C : 000000FF

Instruction : Register address mode

STW.R L0, L6 ; L0[^] = L6 = Address 00001E30 : \$0000FFFF

STD.R L0, L6 ; L0[^] = L6 = Address 00001E30 : \$0000FFFF

; (L0 + 4)[^] = L7 = Address 00001E34 : \$FFFF0000

Instruction : Displacement address mode

STW.D L0, L6, \$8 ; (L0 + 8)[^] = L6 = Address 00001E38 : \$0000FFFF

STD.D L0, L6, \$8 ; (L0 + 8)[^] = L6 = Address 00001E38 : \$0000FFFF

; (L0 + 8 + 4)[^] = L7 = Address 00001E3C : \$FFFF0000

3.2 Move Word Instructions

The source operand or the immediate operand is copied to the destination register and the condition flags are set or cleared accordingly.

Format	Notation	Operation
RR	MOV Rd, Rs	Rd := Rs; Z := Rd = 0; N := Rd(31); V := undefined;
Rimm	MOVI Rd, imm	Rd := imm; Z := Rd = 0; N := Rd(31); V := 0;

3.3 Move Double-Word Instruction

The double-word source operand is copied to the double-word destination register pair and the condition flags are set or cleared accordingly. The high-order word in Rs is copied first.

When the SR is denoted as a source operand, the source operand is supplied as zero regardless of the content of SR//G2. When the PC is denoted as destination, the Return instruction RET is executed instead of the Move Double-Word instruction.

Format	Notation	Operation
RR	MOVD Rd, Rs	if Rd does not denote PC and Rs does not denote SR then Rd := Rs; Rdf := Rsf; Z := Rd//Rdf = 0; N := Rd(31); V := undefined;
RR	MOVD Rd, 0	if Rd does not denote PC and Rs denotes SR then Rd := 0; Rdf := 0; Z := 1; N := 0; V := undefined;
RR	RET PC, Rs	if Rd denotes PC then execute the RET instruction;

Register

```
L0 : $XXXXXXXX
L1 : $XXXXXXXX
L6 : $0000FFFF
L7 : $FFFF0000
```

Instruction

```
MOV L0, L6 ; L0 = L6 = $0000FFFF
```

```
MOVI L0, $4 ; L0 = imm = $4
```

```
MOVD L0, L6 ; L0 = L6 = $0000FFFF
```

```
; L1 = L7 = $FFFF0000
```

3.4 Logical Instructions

The result of a bitwise logical AND, AND not (ANDN), OR or exclusive OR (XOR) of the source or immediate operand and the destination operand is placed in the destination register and the Z flag is set or cleared accordingly. At ANDN, the source operand is used inverted (itself remaining unchanged).

All operands and the result are interpreted as bit-strings of 32 bits each.

Format	Notation	Operation	
RR	AND Rd, Rs	Rd := Rd and Rs; Z := Rd = 0;	-- logical AND
RR	ANDN Rd, Rs	Rd := Rd and not Rs; Z := Rd = 0;	-- logical AND with source used inverted
RR	OR Rd, Rs	Rd := Rd or Rs; Z := Rd = 0;	-- logical OR
RR	XOR Rd, Rs	Rd := Rd xor Rs; Z := Rd = 0;	-- logical exclusive OR
Rimm	ANDNI Rd, imm	Rd := Rd and not imm; Z := Rd = 0;	-- logical AND with imm used inverted
Rimm	ORI Rd, imm	Rd := Rd or imm; Z := Rd = 0;	-- logical OR
Rimm	XORI Rd, imm	Rd := Rd xor imm; Z := Rd = 0;	-- logical exclusive OR

Note: ANDN and ANDNI are the instructions complementary to OR and ORI: Where OR and ORI set bits, ANDN and ANDNI clear bits at bit positions with a "one" bit in the source or immediate operand, thus obviating the need for an inverted mask in most cases.

Register

L0 : \$0F0CFFFF

L1 : \$FFFF0000

Instruction

AND L0, L1 ; L0 = L0 and L1 = \$0F0C0000

ANDN L0, L1 ; L0 = L0 and not L1 = \$0000FFFF

OR L0, L1 ; L0 = L0 or L1 = \$FFFFFFFF

XOR L0, L1 ; L0 = L0 xor L1 = \$F0F3FFFF

ANDNI L0, \$1234 ; L0 = L0 and not imm = \$0F0CEDCB

ORI L0, \$1234 ; L0 = L0 or imm = \$0F0CFFFF

XORI L0, \$1234 ; L0 = L0 xor imm = \$0F0CEDCB

3.5 Invert Instruction

The source operand is placed bitwise inverted in the destination register and the Z flag is set or cleared accordingly.

The source operand and the result are interpreted as bit-strings of 32 bits each.

Format	Notation	Operation
RR	NOT Rd, Rs	Rd := not Rs; Z := Rd = 0;

3.6 Mask Instruction

The result of a bitwise logical AND of the source operand and the immediate operand is placed in the destination register and the Z flag is set or cleared accordingly.

All operands and the result are interpreted as bit-strings of 32 bits each.

Format	Notation	Operation
RRconst	MASK Rd, Rs, const	Rd := Rs and const; Z := Rd = 0;

Note: The Mask instruction may be used to move a source operand with bits partly masked out by an immediate operand used as mask. The immediate operand const is constrained in its range by bits 31 and 30 being either both zero or both one (see format RRconst). If these bits are required to be different, the instruction pair MOVI, AND may be used instead of MASK.

3.7 Add Instructions

The source operand, the source operand + C or the immediate operand is added to the destination operand, the result is placed in the destination register and the condition flags are set or cleared accordingly.

At ADD, ADDC and ADDI, both operands and the result are interpreted as either all signed or all unsigned integers. At ADDS and ADDSI, both operands and the result are signed integers and a trap to Range Error occurs at overflow.

Format	Notation	Operation
RR	ADD Rd, Rs	Rd := Rd + Rs; -- signed or unsigned Add Z := Z and (Rd = 0); N := Rd(31); -- sign V := overflow; C := carry;
RR	ADDS Rd, Rs	Rd := Rd + Rs; -- signed Add with trap Z := Z and (Rd = 0); N := Rd(31); -- sign V := overflow; if overflow then trap ⇒ Range Error;
RR	ADDC Rd, Rs	Rd := Rd + Rs + C; -- signed or unsigned Add Z := Z and (Rd = 0); with carry N := Rd(31); -- sign V := overflow; C := carry;

When the SR is denoted as a source operand at ADD, ADDS and ADDC, C is added instead of the SR. The notation is then:

Format	Notation	Operation
RR	ADD Rd, C	Rd := Rd + C; -- signed or unsigned Add C
RR	ADDS Rd, C	Rd := Rd + C; -- signed Add C with trap
RR	ADDC Rd, C	Rd := Rd + C;

The flags and the trap condition are treated as defined by ADD, ADDS or ADDC.

3.7 Add Instructions (continued)

Format	Notation	Operation
Rimm	ADDI Rd, imm	Rd := Rd + imm; -- signed or unsigned Add Z := Rd = 0; N := Rd(31); -- sign V := overflow; C := carry;
Rimm	ADDSI Rd, imm	Rd := Rd + imm; -- signed Add with trap Z := Rd = 0; N := Rd(31); -- sign V := overflow; if overflow then trap ⇒ Range Error;

The following instructions are special cases of ADDI and ADDSI differentiated by $n = 0$ (see [section 2.3.1. Table of Immediate Values](#)):

Format	Notation	Operation
Rimm	ADDI Rd, CZ	Rd := Rd + (C and (Z = 0 or Rd(0))); -- round to even
Rimm	ADDSI Rd, CZ	Rd := Rd + (C and (Z = 0 or Rd(0))); -- round to even

The flags and the trap condition are treated as defined by ADDI or ADDSI.

Note: At ADDC, Z is cleared if $Rd \neq 0$, otherwise left unchanged; thus, Z is evaluated correctly for multi-precision operands.

The effect of a Subtract immediate instruction can be obtained by using the negated 32-bit value of the immediate operand to be subtracted (except zero). At unsigned, $C = 0$ indicates then a borrow (the unsigned number range is exceeded below zero).

At "round to even", C is only added to the destination operand if $Z = 0$ or $Rd(0)$ is one. The Z flag is assumed to be set or cleared by a preceding Shift Left instruction. "Round to even" provides a better averaging of rounding errors than "add carry".

"Round to even" is equivalent to the "round to nearest" Floating-Point rounding mode and may be used to implement it efficiently.

Register

L0 : \$00000004
L1 : \$FFFFFFFF

Instruction

ADD L0, L1 ; L0 = L0 + L1 = \$0

ADDI L0, \$120 ; L0 = L0 + imm = \$124

3.8 Sum Instructions

The sum of the source operand and the immediate operand is placed in the destination register and the condition flags are set or cleared accordingly. At SUM, both operands and the result are interpreted as either all signed or all unsigned integers. At SUMS, both operands and the result are signed integers and a trap to Range Error occurs at overflow.

Format	Notation	Operation
RRconst	SUM Rd, Rs, const	$Rd := Rs + \text{const};$ -- signed or unsigned Sum $Z := Rd = 0;$ $N := Rd(31);$ -- sign $V := \text{overflow};$ $C := \text{carry};$
RRconst	SUMS Rd, Rs, const	$Rd := Rs + \text{const};$ -- signed Sum with trap $Z := Rd = 0;$ $N := Rd(31);$ -- sign $V := \text{overflow};$ if overflow then trap \Rightarrow Range Error;

When the SR is denoted as a source operand at SUM and SUMS, C is added instead of the SR. The notation is then:

Format	Notation	Operation
RRconst	SUM Rd, C, const	$Rd := C + \text{const};$ -- signed or unsigned Sum C
RRconst	SUMS Rd, C, const	$Rd := C + \text{const};$ -- signed Sum C

The flags are treated as defined by SUM or SUMS. A trap cannot occur.

Note: The effect of a Subtract immediate instruction can be obtained by using the negated 32-bit value of the immediate operand to be subtracted (except zero). At unsigned, $C = 0$ indicates then a borrow (the unsigned number range is exceeded below zero).

The immediate operand is constrained to the range of const. The instruction pair MOV, ADDI or MOV, ADDSI may be used where the full integer range is required.

Register

L0 : \$FFFFFFFC

L1 : \$00000004

Instruction

SUM L0, L1, \$120 ; L0 = L1 + const = \$124

3.9 Subtract Instructions

The source operand or the source operand + C is subtracted from the destination operand, the result is placed in the destination register and the condition flags are set or cleared accordingly.

At SUB and SUBC, both operands and the result are interpreted as either all signed or all unsigned integers. At SUBS, both operands and the result are signed integers and a trap to Range Error occurs at overflow.

Format	Notation	Operation
RR	SUB Rd, Rs	$Rd := Rd - Rs;$ -- signed or unsigned Subtract $Z := Rd = 0;$ $N := Rd(31);$ -- sign $V := \text{overflow};$ $C := \text{borrow};$
RR	SUBS Rd, Rs	$Rd := Rd - Rs;$ -- signed Subtract with trap $Z := Rd = 0;$ $N := Rd(31);$ -- sign $V := \text{overflow};$ if overflow then trap \Rightarrow Range Error;
RR	SUBC Rd, Rs	$Rd := Rd - (Rs + C);$ -- signed or unsigned Subtract $Z := Z \text{ and } (Rd = 0);$ with borrow $N := Rd(31);$ -- sign $V := \text{overflow};$ $C := \text{borrow};$

When the SR is denoted as a source operand at SUB, SUBS and SUBC, C is subtracted instead of the SR. The notation is then:

Format	Notation	Operation
RR	SUB Rd, C	$Rd := Rd - C;$ -- signed or unsigned Subtract C
RR	SUBS Rd, C	$Rd := Rd - C;$ -- signed Subtract C with trap
RR	SUBC Rd, C	$Rd := Rd - C;$

The flags and the trap condition are treated as defined by SUB, SUBS or SUBC.

Note: At SUBC, Z is cleared if $Rd \neq 0$, otherwise left unchanged; thus, Z is evaluated correctly for multi-precision operands.

```

Register
  L0 : $124
  L1 : $4
Instruction
  SUB  L0, L1      ; L0 = L0 - L1 = $120
  
```

3.10 Negate Instructions

The source operand is subtracted from zero, the result is placed in the destination register and the condition flags are set or cleared accordingly.

At NEG and NEGS, the source operand and the result are interpreted as either both signed or both unsigned integers. At NEGS, the source operand and the result are signed integers and a trap to Range Error occurs at overflow.

Format	Notation	Operation
RR	NEG Rd, Rs	$Rd := -Rs;$ $Z := Rd = 0;$ $N := Rd(31);$ $V := \text{overflow};$ $C := \text{borrow};$
RR	NEGS Rd, Rs	$Rd := -Rs;$ $Z := Rd = 0;$ $N := Rd(31);$ $V := \text{overflow};$ if overflow then trap \Rightarrow Range Error;

When the SR is denoted as a source operand at NEG and NEGS, C is negated instead of the SR. The notation is then:

Format	Notation	Operation
RR	NEG Rd, C	$Rd := -C;$
RR	NEGS Rd, C	$Rd := -C;$

The flags are treated as defined by NEG or NEGS. A trap cannot occur.

Register

L0 : \$124

L1 : \$4

Instruction

NEG L0, L1 ; L0 = - L1 = \$FFFFFFFC

3.11 Multiply Word Instruction

The source operand and the destination operand are multiplied, the low-order word of the product is placed in the destination register (the high-order product word is not evaluated) and the condition flags are set or cleared according to the single-word product.

Both operands are either signed or unsigned integers, the product is a single-word integer.

Note that the low-order word of the product is identical regardless of whether the operands are signed or unsigned.

The result is undefined if the PC or the SR is denoted.

Format	Notation	Operation
RR	MUL Rd, Rs	Rd := low order word of product Rd * Rs; Z := singleword product = 0; N := Rd(31); -- sign of singleword product; -- valid for signed operands; V := undefined; C := undefined;

3.12 Multiply Double-Word Instructions

The source operand and the destination operand are multiplied, the double-word product is placed in the destination register pair (the destination register expanded by the register following it) and the condition flags are set or cleared according to the double-word product.

At MULS, both operands are signed integers and the product is a signed double-word integer. At MULU, both operands are unsigned integers and the product is an unsigned double-word integer.

The result is undefined if the PC or the SR is denoted.

Format	Notation	Operation
RR	MULS Rd, Rs	Rd//Rdf := signed doubleword product of Rd * Rs; Z := Rd//Rdf = 0; -- doubleword product is zero N := Rd(31); -- doubleword product is negative V := undefined; C := undefined;
RR	MULU Rd, Rs	Rd//Rdf := unsigned doubleword product of Rd * Rs; Z := Rd//Rdf = 0; -- doubleword product is zero N := Rd(31); V := undefined; C := undefined;

Register
 L0 : \$5678
 L1 : \$1234
 L2 : \$9ABC

Instruction		
<i>MUL</i>	<i>L0, L2</i>	; L0 = \$3443B020
<i>MULU</i>	<i>L0, L2</i>	; L0 = \$0 ; L1 = \$3443B020

3.13 Divide Instructions

The double-word destination operand (dividend) is divided by the single-word source operand (divisor), the quotient is placed in the low-order destination register (Rdf), the remainder is placed in the high-order destination register (Rd) and the condition flags are set or cleared according to the quotient.

A trap to Range Error occurs if the divisor is zero or the value of the quotient exceeds the integer value range (quotient overflow). The result (in Rd//Rdf) is then undefined. At DIVS, a trap to Range Error also occurs and the result is undefined if the dividend is negative.

At DIVS, the dividend is a non-negative signed double-word integer, the divisor, the quotient and the remainder are signed integers; a non-zero remainder has the sign of the dividend.

At DIVU, the dividend is an unsigned double-word integer, the divisor, the quotient and the remainder are unsigned integers.

The result is undefined if Rs denotes the same register as Rd or Rdf or if the PC or the SR is denoted.

Format	Notation	Operation
RR	DIVS Rd, Rs	if Rs = 0 or quotient overflow or Rd(31) = 1 then -- dividend is negative Rd//Rdf := undefined; Z := undefined; N := undefined; V := 1; trap ⇒ Range Error; else remainder Rd, quotient Rdf := (Rd//Rdf) / Rs; Z := Rdf = 0; -- quotient is zero N := Rdf(31); -- quotient is negative V := 0;
RR	DIVU Rd, Rs	if Rs = 0 or quotient overflow then Rd//Rdf := undefined; Z := undefined; N := undefined; V := 1; trap ⇒ Range Error; else remainder Rd, quotient Rdf := (Rd//Rdf) / Rs; Z := Rdf = 0; -- quotient is zero N := Rdf(31); V := 0;

Register

L0 : \$1

L1 : \$23456789

L2 : 123456

Instruction

DIVU ***L0, L2*** ; L0 = \$789
 ; L1 = \$1000

3.14 Shift Left Instructions

The destination operand is shifted left by a number of bit positions specified

at SHLI, SHLDI by $n = 0..31$ as a shift by $0..31$;

at SHL, SHLD by bits 4..0 of the source operand as a shift by $0..31$.

The higher-order bits of the source operand are ignored.

The destination operand is interpreted

at SHL and SHLI as a bit-string of 32 bits or as a signed or unsigned integer;

at SHLD and SHLDI as a double-word bit-string of 64 bits or as a signed or unsigned double-word integer.

All Shift Left instructions insert zeros in the vacated bit positions at the right.

The double-word Shift Left instructions execute in two cycles. The low-order operand in Ldf is shifted first. At SHLD, the result is undefined if Ls denotes the same register as Ld or Ldf.

Format	Notation	Operation	insert
Rn	SHLI Rd, n	Rd := Rd << by n;	-- 0..31 zeros
Ln	SHLDI Ld, n	Ld//Ldf := Ld//Ldf << by n;	-- 0..31 zeros
LL	SHL Ld, Ls	Ld := Ld << by Ls(4..0);	-- 0..31 zeros
LL	SHLD Ld, Ls	Ld//Ldf := Ld//Ldf << by Ls(4..0);	-- 0..31 zeros

The condition flags are set or cleared by all Shift Left instructions as follows:

Z := Ld = 0 or Rd = 0 on single-word;
 Z := Ld//Ldf = 0 on double-word;
 N := Ld(31) or Rd(31);
 V := undefined
 C := undefined;

Note: The symbol << signifies "shifted left".

Register

L0 : \$FFFF

L1 : \$2

Instruction

SHLI L0, \$4 ; L0 = \$000FFFF0

SHL L0, L1 ; L0 = \$0003FFFC

3.15 Shift Right Instructions

The destination operand is shifted right by a number of bit positions specified

at SARI, SARDI, SHRI, SHRDI by $n = 0..31$ as a shift by $0..31$.

at SAR, SARD, SHR, SHRD by bits 4..0 of the source operand as a shift by $0..31$.

The higher-order bits of the source operand are ignored.

The destination operand is interpreted

at SAR and SARI as a signed integer;

at SARD and SARDI as a signed double-word integer;

at SHR and SHRI as a bit-string of 32 bits or as an unsigned integer;

at SHRD and SHRDI as a double-word bit-string of 64 bits or as an unsigned double-word integer.

All Shift Right instructions which interpret the destination operand as signed insert sign bits, all others insert zeros in the vacated bit positions at the left.

The double-word Shift Right instructions execute in two cycles. The high-order operand in Ld is shifted first. At SARD and SHRD, the result is undefined if Ls denotes the same register as Ld or Ldf.

Format	Notation	Operation	insert
Rn	SARI Rd, n	Rd := Rd >> by n;	-- 0..31 sign bits
Ln	SARDI Ld, n	Ld//Ldf := Ld//Ldf >> by n;	-- 0..31 sign bits
LL	SAR Ld, Ls	Ld := Ld >> by Ls(4..0);	-- 0..31 sign bits
LL	SARD Ld, Ls	Ld//Ldf := Ld//Ldf >> by Ls(4..0);	-- 0..31 sign bits
Rn	SHRI Rd, n	Rd := Rd >> by n;	-- 0..31 zeros
Ln	SHRDI Ld, n	Ld//Ldf := Ld//Ldf >> by n;	-- 0..31 zeros
LL	SHR Ld, Ls	Ld := Ld >> by Ls(4..0);	-- 0..31 zeros
LL	SHRD Ld, Ls	Ld//Ldf := Ld//Ldf >> by Ls(4..0);	-- 0..31 zeros

The condition flags are set or cleared by all Shift Right instructions as follows:

Z := Ld = 0 or Rd = 0 on single-word;

Z := Ld//Ldf = 0 on double-word;

N := Ld(31) or Rd(31);

C := last bit shifted out is "one";

Note: The symbol >> signifies "shifted right".

Register

L0 : \$C000FFFF

L1 : \$2

Instruction

SARI *L0, \$4* ; L0 = \$FC000FFF**SAL** *L0, L1* ; L0 = \$F0003FFF**SHRI** *L0, \$4* ; L0 = \$0C000FFF**SHL** *L0, L1* ; L0 = \$30003FFF

3.16 Rotate Left Instruction

The destination operand is shifted left by a number of bit positions and the bits shifted out are inserted in the vacated bit positions; thus, the destination operand is rotated. The condition flags are set or cleared accordingly. Bits 4..0 of the source operand specify a rotation by 0..31 bit positions; bits 31..5 of the source operand are ignored.

The destination operand is interpreted as a bit-string of 32 bits.

Format	Notation	Operation
LL	ROL <i>Ld, Ls</i>	Ld := Ld rotated left by Ls(4..0); Z := Ld = 0; N := Ld(31); V := undefined; C := undefined;

Note: The condition flags are set or cleared by the same rules applying to the Shift Left instructions.

Register

L0 : \$C000FFFF

L1 : \$4

Instruction

ROL *L0, L1* ; L0 = \$000FFFFC

3.17 Index Move Instructions

The source operand is placed shifted left by 0, 1, 2 or 3 bit positions in the destination register, corresponding to a multiplication by 1, 2, 4 or 8. At XM1..XM4, a trap to Range Error occurs if the source operand is higher than the immediate operand *lim* (upper bound).

All condition flags remain unchanged. All operands and the result are interpreted as unsigned integers.

The SR must not be denoted as a source or as a destination, nor the PC as a destination operand; these notations are reserved for future expansion. When the PC is denoted as a source operand, a trap to Range Error occurs if $PC \geq \text{lim}$.

X-code	Format	Notation	Operation
0	RRlim	XM1 Rd, Rs, lim	Rd := Rs * 1; if Rs > lim then trap ⇒ Range Error;
1	RRlim	XM2 Rd, Rs, lim	Rd := Rs * 2; if Rs > lim then trap ⇒ Range Error;
2	RRlim	XM4 Rd, Rs, lim	Rd := Rs * 4; if Rs > lim then trap ⇒ Range Error;
3	RRlim	XM8 Rd, Rs, lim	Rd := Rs * 8; if Rs > lim then trap ⇒ Range Error;
4	RRlim	XX1 Rd, Rs, 0	Rd := Rs * 1; -- Move without flag change
5	RRlim	XX2 Rd, Rs, 0	Rd := Rs * 2;
6	RRlim	XX4 Rd, Rs, 0	Rd := Rs * 4;
7	RRlim	XX8 Rd, Rs, 0	Rd := Rs * 8;

Note: The Index Move instructions move an index value scaled (multiplied by 1, 2, 4 or 8). XM1..XM4 check also the unscaled value for an upper bound, optionally also excluding zero. If the lower bound is not zero or one, it may be mapped to zero by subtracting it from the index value before applying an Index Move instruction.

Register
L0 : \$456
L1 : \$123

Instruction
XM2 *L0, L1, 124* ; L0 = \$246

XM2 *L0, L1, 122* ; Integer Range Error in Task at Address XXXXXXXXX
XX2 *L0, L1, 0* ; L0 = \$246

3.18 Check Instructions

The destination operand is checked and a trap to Range Error occurs

- at CHK if the destination operand is higher than the source operand,
- at CHKZ if the destination operand is zero.

All registers and all condition flags remain unchanged. All operands are interpreted as unsigned integers.

CHKZ shares its basic OP-code with CHK, it is differentiated by denoting the SR as source operand.

Format	Notation	Operation
RR	CHK Rd, Rs	if Rs does not denote SR and $Rd > Rs$ then trap \Rightarrow Range Error;
RR	CHKZ Rd, 0	if Rs denotes SR and $Rd = 0$ then trap \Rightarrow Range Error;

When Rs denotes the PC, CHK traps if $Rd \geq PC$. Thus, CHK, PC, PC always traps. Since CHK, PC, PC is encoded as 16 zeros, an erroneous jump into a string of zeros causes a trap to Range Error, thus trapping some address errors.

Note: CHK checks the upper bound of an unsigned value range, implying a lower bound of zero. If the lower bound is not zero, it can be mapped to zero by subtracting it from the value to be checked and then checking against a corrected upper bound (lower bound also subtracted). When the upper bound is a constant not exceeding the range of lim, the Index instructions may be used for bound checks.

CHKZ may be used to trap on uninitialized pointers with the value zero.

3.19 No Operation Instruction

The instruction CHK, L0, L0 cannot cause any trap. Since CHK leaves all registers and condition flags unchanged, it can be used as a No Operation instruction with the notation:

Format	Notation	Operation
RR	NOP	no operation;

Note: The NOP instruction may be used as a fill instruction.

3.20 Compare Instructions

Two operands are compared by subtracting the source operand or the immediate operand from the destination operand. The condition flags are set or cleared according to the result; the result itself is not retained. Note that the N flag indicates the correct compare result even in the case of an overflow.

All operands and the result are interpreted as either all signed or all unsigned integers.

Format	Notation	Operation
RR	CMP Rd, Rs	result := Rd - Rs; Z := Rd = Rs; -- result is zero N := Rd < Rs signed; -- result is true negative V := overflow; C := Rd < Rs unsigned; -- borrow
Rimm	CMPI Rd, imm	result := Rd - imm; Z := Rd = imm; -- result is zero N := Rd < imm signed; -- result is true negative V := overflow; C := Rd < imm unsigned; -- borrow

When the SR is denoted as a source operand at CMP, C is subtracted instead of SR. The notation is then:

Format	Notation	Operation
RR	CMP, Rd, C	result := Rd - C; Z := Rd = C; -- result is zero N := Rd < C signed; -- result is true negative V := overflow; C := Rd < C unsigned; -- borrow

3.21 Compare Bit Instructions

The result of a bitwise logical AND of the source or immediate operand and the destination operand is used to set or clear the Z flag accordingly; the result itself is not retained.

All operands and the result are interpreted as bit-strings of 32 bits each.

Format	Notation	Operation
RR	CMPB Rd, Rs	Z := (Rd and Rs) = 0;
Rimm	CMPBI Rd, imm	Z := (Rd and imm) = 0;

The following instruction is a special case of CMPBI differentiated by n = 0 (see [section 2.3.1. Table of Immediate Values](#)):

Format	Notation	Operation
Rimm	CMPBI Rd, ANYBZ	Z := Rd(31..24) = 0 or Rd(23..16) = 0 or Rd(15..8) = 0 or Rd(7..0) = 0; -- any Byte of Rd = 0

3.22 Test Leading Zeros Instruction

The number of leading zeros in the source operand is tested and placed in the destination register. A source operand equal to zero yields 32 as a result. All condition flags remain unchanged.

Format	Notation	Operation
LL	TESTLZ Ld, Ls	Ld := number of leading zeros in Ls;

3.23 Set Stack Address Instruction

The frame pointer FP is placed, expanded to the stack address, in the destination register. The FP itself and all condition flags remain unchanged. The expanded FP address is the address at which the content of L0 would be stored if pushed onto the memory part of the stack.

The Set Stack Address instruction shares the basic OP-code SETxx, it is differentiated by $n = 0$ and not denoting the SR or the PC.

n	Format	Notation	Operation
0	Rn	SETADR Rd	Rd := SP(31..9)//SR(31..25)//00 + carry into bit 9 -- SR(31..25) is FP -- carry into bit 9 := (SP(8) = 1 and SR(31) = 0)

Note: The Set Stack Address instruction calculates the stack address of the beginning of the current stack frame. L0..L15 of this frame can then be addressed relative to this stack address in the stack address mode with displacement values of 0..60 respectively.

Provided the stack address of a stack frame has been saved, for example in a global register, any data in this stack frame can then be addressed also from within all younger generations of stack frames by using the saved stack address. (Addressing of local variables in older generations of stack frames is required by all block oriented programming languages like Pascal, Modula-2 and Ada.)

The basic OP-code SETxx is shared as indicated:

- ı $n = 0$ while not denoting the SR or the PC differentiates the Set Stack Address instruction.
- ı $n = 1..31$ while not denoting the SR or the PC differentiates the Set Conditional instructions.
- ı Denoting the SR differentiates the Fetch instruction.
- ı Denoting the PC is reserved for future use.

3.24 Set Conditional Instructions

The destination register is set or cleared according to the states of the condition flags specified by n . The condition flags themselves remain unchanged.

The Set Conditional instructions share the basic OP-code SETxx, they are differentiated by $n = 1..31$ and not denoting the SR or the PC.

3.24 Set Conditional Instructions (continued)

Format is Rn

n	Notation	or	Alternative	Operation
1	Reserved			
2	SET1	Rd		Rd := 1;
3	SET0	Rd		Rd := 0;
4	SETLE	Rd		if N = 1 or Z = 1 then Rd := 1 else Rd := 0;
5	SETGT	Rd		if N = 0 and Z = 0 then Rd := 1 else Rd := 0;
6	SETLT	Rd	SETN Rd	if N = 1 then Rd := 1 else Rd := 0;
7	SETGE	Rd	SETNN Rd	if N = 0 then Rd := 1 else Rd := 0;
8	SETSE	Rd		if C = 1 or Z = 1 then Rd := 1 else Rd := 0;
9	SEHT	Rd		if C = 0 and Z = 0 then Rd := 1 else Rd := 0;
10	SETST	Rd	SETC Rd	if C = 1 then Rd := 1 else Rd := 0;
11	SETHE	Rd	SETNC Rd	if C = 0 then Rd := 1 else Rd := 0;
12	SETE		SETZ	if Z = 1 then Rd := 1 else Rd := 0;
13	SETNE		SETNZ	if Z = 0 then Rd := 1 else Rd := 0;
14	SETV	Rd		if V = 1 then Rd := 1 else Rd := 0;
15	SETNV	Rd		if V = 0 then Rd := 1 else Rd := 0;
16	Reserved			
17	Reserved			
18	SET1M	Rd		Rd := -1;
19	Reserved			
20	SETLEM	Rd		if N = 1 or Z = 1 then Rd := -1 else Rd := 0;
21	SETGTM	Rd		if N = 0 and Z = 0 then Rd := -1 else Rd := 0;
22	SETLTM	Rd	SETNM Rd	if N = 1 then Rd := -1 else Rd := 0;
23	SETGEM	Rd	SETNNM Rd	if N = 0 then Rd := -1 else Rd := 0;
24	SETSEM	Rd		if C = 1 or Z = 1 then Rd := -1 else Rd := 0;
25	SEHTM	Rd		if C = 0 and Z = 0 then Rd := -1 else Rd := 0;
26	SETSTM	Rd	SETCM Rd	if C = 1 then Rd := -1 else Rd := 0;
27	SETHEM	Rd	SETNCM Rd	if C = 0 then Rd := -1 else Rd := 0;
28	SETEM		SETZM	if Z = 1 then Rd := -1 else Rd := 0;
29	SETNEM		SETNZM	if Z = 0 then Rd := -1 else Rd := 0;
30	SETVM	Rd		if V = 1 then Rd := -1 else Rd := 0;
31	SETNVM	Rd		if V = 0 then Rd := -1 else Rd := 0;

3.25 Branch Instructions

The Branch instruction BR, and any of the conditional Branch instructions when the branch condition is met, place the branch address $PC + rel$ (relative to the address of the first byte after the Branch instruction) in the program counter PC and clear the cache-mode flag M; all condition flags remain unchanged. Then instruction execution proceeds at the branch address placed in the PC.

When the branch condition is not met, the M flag and the condition flags remain unchanged and instruction execution proceeds sequentially.

Besides these explicit Branch instructions, the instructions MOV, MOVI, ADD, ADDI, SUM, SUB may denote the PC as a destination register and thus be executed as an implicit branch; the M flag is cleared and the condition flags are set or cleared according to the specified instruction. All other instructions, except Compare instructions, must not be used with the PC as destination, otherwise possible Range Errors caused by these instructions would lead to ambiguous results on backtracking.

Format is PCrel

Notation	or alternative	Operation	Comment
BLE	rel	if $N = 1$ or $Z = 1$ then BR;	-- Less or Equal signed
BGT	rel	if $N = 0$ and $Z = 0$ then BR;	-- Greater Than signed
BLT	rel BN rel	if $N = 1$ then BR;	-- Less Than signed
BGE	rel BNN rel	if $N = 0$ then BR;	-- Greater or Equal signed
BSE	rel	if $C = 1$ or $Z = 1$ then BR;	-- Smaller or Equal unsigned
BHT	rel	if $C = 0$ and $Z = 0$ then BR;	-- Higher Than unsigned
BST	rel BC rel	if $C = 1$ then BR;	-- Smaller Than unsigned
BHE	rel BNC rel	if $C = 0$ then BR;	-- Higher or Equal unsigned
BE	rel BZ rel	if $Z = 1$ then BR;	-- Equal
BNE	rel BNZ rel	if $Z = 0$ then BR;	-- Not Equal
BV	rel	if $V = 1$ then BR;	-- oVerflow
BNV	rel	if $V = 0$ then BR;	-- Not oVerflow
BR	rel	$PC := PC + rel$; $M := 0$;	

Note: rel is signed to allow forward or backward branches.

Instruction

Loop1: *MOVI L0, \$1234*
 BLE Loop1 ; if $N=1$ or $Z=1$ then branch

BNE Loop1 ; if $Z=0$ then branch

3.26 Delayed Branch Instructions

The Delayed Branch instruction DBR, and any of the conditional Delayed Branch instructions when the branch condition is met, place the branch address $PC + rel$ (relative to the address of the first byte after the Delayed Branch instruction) in the program counter PC. All condition flags and the cache mode flag M remain unchanged.

Then the instruction after the Delayed Branch instruction, called the delay instruction, is executed regardless of whether the delayed branch is taken or not taken.

When the delayed branch is not taken, the delay instruction is executed like a regular instruction. The PC and the ILC are updated accordingly and instruction execution proceeds sequentially.

When the delayed branch is taken, the delay instruction is executed before execution proceeds at the branch target. The PC (containing the delayed-branch target address) is not updated by the delay instruction. Any reference to the PC by the delay instruction references the delayed-branch target address.

In the case of an Error exception caused by a delay instruction succeeding a delayed branch taken, the location of the saved return PC contains the address of the first byte of the delay instruction. The saved ILC contains the length (1 or 2 halfwords) of the Delayed Branch instruction. In the case of all other exceptions following a delay instruction succeeding a delayed branch taken, the location of the saved return PC contains the branch target address of the delayed branch and the saved ILC is invalid.

The following restrictions apply to delay instructions:

The sum of the length of the Delayed Branch instruction and the delay instruction must not exceed three halfwords, otherwise an arbitrary bit pattern may be supplied and erroneously used for the second or third halfword of the delay instruction without any warning.

The Delayed Branch instruction and the delay instruction are locked against any exception except Reset.

A Fetch or any branching instruction must not be placed as a delay instruction. A misplaced Delayed Branch instruction would be executed like the corresponding non-delayed Branch instruction to inhibit a permanent exception lock-out.

3.26 Delayed Branch Instructions (continued)

Format is PCrel

Notation or alternative	Operation	Comment
DBLE rel	if N = 1 or Z = 1 then DBR;	-- Less or Equal signed
DBGT rel	if N = 0 and Z = 0 then DBR;	-- Greater Than signed
DBLT rel DBN rel	if N = 1 then DBR;	-- Less Than signed
DBGE rel DBNN rel	if N = 0 then DBR;	-- Greater or Equal signed
DBSE rel	if C = 1 or Z = 1 then DBR;	-- Smaller or Equal unsigned
DBHT rel	if C = 0 and Z = 0 then DBR;	-- Higher Than unsigned
DBST rel DBC rel	if C = 1 then DBR;	-- Smaller Than unsigned
DBHE rel DBNC rel	if C = 0 then DBR;	-- Higher or Equal unsigned
DBE rel DBZ rel	if Z = 1 then DBR;	-- Equal
DBNE rel DBNZ rel	if Z = 0 then DBR;	-- Not Equal
DBV rel	if V = 1 then DBR;	-- oVerflow
DBNV rel	if V = 0 then DBR;	-- Not oVerflow
DBR rel	PC := PC + rel;	

Note: rel is signed to allow forward or backward branches.

Attention: Since the PC seen by the delay instruction depends on the delayed branch taken or not taken, a delay instruction after a conditional Delayed Branch instruction must not reference the PC.

Instruction			
<i>Loop1:</i>	<i>MOVI</i>	<i>L0, \$1234</i>	
	<i>DBLE</i>	<i>Loop1</i>	; if N=1 or Z=1 then delay branch
	<i>ADDI</i>	<i>L0, \$10</i>	; => if N=1 or Z=1
			; then L0 = L0 + \$10, branch to Loop1
	<i>DBNE</i>	<i>Loop1</i>	; if Z=0 then delay branch
	<i>ADDI</i>	<i>L0, \$10</i>	; => if N=1 or Z=1
			; then L0 = L0 + \$10, branch to Loop1

3.27 Call Instruction

The Call instruction causes a branch to a subprogram.

The branch address $R_s + \text{const}$, or const alone if R_s denotes the SR, is placed in the program counter PC. The old PC containing the return address is saved in Ld; the old supervisor-state flag S is also saved in bit zero of Ld. The old status register SR is saved in Ldf; the saved instruction-length code ILC contains the length (2 or 3) of the Call instruction.

Then the frame pointer FP is incremented by the value of the Ld-code (Ld-code = 0 is interpreted as Ld-code = 16) and the frame length FL is set to six, thus creating a new stack frame. The cache-mode flag M is cleared. All condition flags remain unchanged. Then instruction execution proceeds at the branch address placed in the PC.

The value of the Ld-code must not exceed the value of the old FL (FL = 0 is interpreted as FL = 16), otherwise the beginning of the register part of the stack at the SP could be overwritten without any warning. Bit zero of const must be 0.

R_s and Ld may denote the same register.

Format	Notation	Operation
LRconst	CALL Ld, Rs, const or CALL Ld, 0, const	if R_s denotes not SR then PC := $R_s + \text{const}$; else PC := const; Ld := old PC(31..1)//old S; -- Ld-code 0 selects L16 Ldf := old SR; FP := FP + Ld code; -- Ld-code 0 is treated as 16 FL := 6; M := 0;

Note: At the new stack frame, the saved PC is located in L0 and the saved SR is located in L1.

A Frame instruction must be executed immediately after a Call instruction, otherwise an Interrupt, Parity Error, Extended Overflow or Trace exception could separate the Call from the corresponding Frame instruction before the frame pointer FP is decreased to include (optionally) passed parameters. After a Call instruction, an Interrupt, Parity Error, Extended Overflow or Trace exception is locked out for one instruction regardless of the interrupt lock flag L.

```

_Main:    FRAME    L4, L0
          MOVDL2, G10
          CALL     L6, 0, Sub_Start      ; PC = Sub_Start
          MOVDG10, L2
          RET      PC, L0

Sub_Start: FRAME    L3, L0
          MOVI L2,  $124
          RET      PC, L0

```

3.28 Trap Instructions

The Trap instructions TRAP and any of the conditional Trap instructions when the trap condition is met, cause a branch to one out of 64 supervisor subprogram entries (see [section 2.4. Entry Tables](#)).

When the trap condition is not met, instruction execution proceeds sequentially.

When the subprogram branch is taken, the subprogram entry address *adr* is placed in the program counter PC and the supervisor-state flag *S* is set to one. The old PC containing the return address is saved in the register addressed by *FP + FL*; the old *S* flag is also saved in bit zero of this register. The old status register *SR* is saved in the register addressed by *FP + FL + 1* (*FL = 0* is interpreted as *FL = 16*); the saved instruction-length code *ILC* contains the length (1) of the Trap instruction.

Then the frame pointer *FP* is incremented by the old frame length *FL* and *FL* is set to six, thus creating a new stack frame. The cache-mode flag *M* and the trace-mode flag *T* are cleared, the interrupt-lock flag *L* is set to one. All condition flags remain unchanged. Then instruction execution proceeds at the entry address placed in the PC.

The trap instructions are differentiated by the 12 code values given by the bits 9 and 8 of the OP-code and bits 1 and 0 of the *adr*-byte ($\text{code} = \text{OP}(9..8) // \text{adr}\text{-byte}(1..0)$). Since $\text{OP}(9..8) = 0$ does not denote Trap instructions (the code is occupied by the BR instruction), trap codes 0..3 are not available.

Format is PC*adr*

Code	Notation	Operation
4	TRAPLE trapno	if <i>N</i> = 1 or <i>Z</i> = 1 then execute TRAP else execute next instruction;
5	TRAPGT trapno	if <i>N</i> = 0 and <i>Z</i> = 0 then execute TRAP else execute next instruction;
6	TRAPLT trapno	if <i>N</i> = 1 then execute TRAP else execute next instruction;
7	TRAPGE trapno	if <i>N</i> = 0 then execute TRAP else execute next instruction;
8	TRAPSE trapno	if <i>C</i> = 1 or <i>Z</i> = 1 then execute TRAP else execute next instruction;
9	TRAPHT trapno	if <i>C</i> = 0 and <i>Z</i> = 0 then execute TRAP else execute next instruction;
10	TRAPST trapno	if <i>C</i> = 1 then execute TRAP else execute next instruction;
11	TRAPHE trapno	if <i>C</i> = 0 then execute TRAP else execute next instruction;
12	TRAPE trapno	if <i>Z</i> = 1 then execute TRAP else execute next instruction;
13	TRAPNE trapno	if <i>Z</i> = 0 then execute TRAP else execute next instruction;
14	TRAPV trapno	if <i>V</i> = 1 then execute TRAP else execute next instruction;
15	TRAP trapno	PC := <i>adr</i> ; S := 1; (FP + FL) [^] := old PC(31..1)//old S; (FP + FL + 1) [^] := old SR; FP := FP + FL; -- FL = 0 is treated as FL = 16 FL := 6; M := 0; T := 0; L := 1;

trapno indicates one of the traps 0..63.

Note: At the new stack frame, the saved PC is located in L0 and the saved SR is located in L1; L2..L5 are free for use as required.

A Frame instruction must be executed before executing any other Trap, Call or Software instruction or before the interrupt-lock flag L is being cleared, otherwise the beginning of the register part of the stack at the SP could be overwritten without any warning.

3.29 Frame Instruction

A Frame instruction restructures the current stack frame by

- i ü decreasing the frame pointer FP to include (optionally) passed parameters in the local register addressing range; the first parameter passed is then addressable as L0;
- i ü resetting the frame length FL to the actual number of registers needed for the current stack frame.

It also restores the reserve number of 10 registers in the register part of the stack to allow any further Call, Trap or Software instructions and clears the cache mode flag M.

The frame pointer FP is decreased by the value of the Ls-code and the Ld-code is placed in the frame length FL (FL = 0 is always interpreted as FL = 16). Then the difference (available number of registers) - (required number of registers + 10) is evaluated and interpreted as a signed 7-bit integer.

If the difference is not negative, all the registers required plus the reserve of 10 fit into the register part of the stack; no further action is needed and the Frame instruction is finished.

If the difference is negative, the content of the old stack pointer SP is compared with the address in the upper stack bound UB. If the value in the SP is equal or higher than the value in the UB, a temporary flag is set. Then the contents of the number of local registers equal to the negative difference evaluated are pushed onto the memory part of the stack, beginning with the content of the local register addressed absolutely by SP(7..2) being pushed onto the location addressed by the SP. After each memory cycle, the SP is incremented by four until the difference is eliminated. A trap to Frame Error occurs after completion of the push operation when the temporary flag is set.

All condition flags remain unchanged.

3.29 Frame Instruction (continued)

Format	Notation	Operation
LL	FRAME Ld, Ls	<pre> FP := FP - Ls code; FL := Ld code; M := 0; difference(6..0) := SP(8..2) + (64 - 10) - (FP + FL); -- FL = 0 is treated as FL = 16 -- difference is signed, difference(6) = sign bit -- 64 = number of local registers -- 10 = number of reserve registers if difference ≥ 0 then continue at next instruction; -- Frame is finished else temporary flag := SP ≥ UB; repeat memory SP^ := register SP(7..2)^; -- local register ⇒ memory SP := SP + 4; difference := difference + 1; until difference = 0; if temporary flag = 1 then trap ⇒ Frame Error; </pre>

Note: Ls also identifies the same source operand that must be denoted by the Return instruction to address the saved return PC.

Ld (L0 is interpreted as L16) also identifies the register in which the return PC is being saved by a Trap or Software instruction or by an exception; therefore only local registers with a lower register code than the interpreted Ld-code of the Frame instruction may be used after execution of a Frame instruction.

The reserve of 10 registers is to be used as follows:

- ı ü A Call, Trap or Software instruction uses six registers.
- ı ü A subsequent exception, occurring before a Frame instruction is executed, uses another two registers.
- ı ü Two registers remain in reserve.

Note that the Frame instruction can write into the memory stack at address locations up to 37 words higher than indicated by the address in the UB. This is due to the fact that the upper bound is checked before the execution of the Frame instruction.

Attention: The Frame instruction must always be the first instruction executed in a function entered by a Call instruction, otherwise the Frame instruction could be separated from the preceding Call instruction by an Interrupt, Parity Error, Extended Overflow or Trace exception (see [section 3.27. Call instruction](#)).

```

_Main:   FRAME    L3, L0      ; L0 = SP
                                   ; L1 = SR

        MOVDL2, G10

        RET      PC, L0

```

3.30 Return Instruction

The Return instruction returns control from a subprogram entered through a Call, Trap or Software instruction or an exception to the instruction located at the return address and restores the status from the saved return status.

The source operand pair Rs//Rsf is placed in the register pair PC//SR. The program counter PC is restored first from Rs. Then all bits of the status register SR are replaced by Rsf, except the supervisor flag S, which is restored from bit zero of Rs and except the instruction length code ILC, which is cleared to zero.

If the return occurred from user to supervisor state or if the interrupt-lock flag L was changed from zero to one on return from any state to user state, a trap to Privilege Error occurs. Exception processing saves the restored contents of the register pair PC//SR; an illegally set S or L flag is also saved.

Then the difference between frame pointer FP - stack pointer SP(8..2) is evaluated and interpreted as a signed 7-bit integer. If the difference is not negative, the register pointed to by FP(5..0) is in the register part of the stack; no further action is then required and the Return instruction is completed.

If the difference is negative, the number of words equal to the negative difference are pulled from the memory part of the stack and transferred to the register part of the stack, beginning with the contents of the memory location SP - 4 being transferred to the local register addressed absolutely by bits 7..2 of SP - 4. After each memory cycle, the SP is decreased by four until the difference is eliminated.

The Return instruction shares its basic OP-code with the Move Double-Word instruction. It is differentiated from it by denoting the PC as destination register Rd.

The PC or the SR must not be denoted as a source operand; these notations are reserved for future expansion.

Format	Notation	Operation
RR	RET PC, Rs	<pre> old S := S; old L := L; PC := Rs(31..1)//0; SR := Rsf(31..21)//00//Rs(0)//Rsf(17..0); -- ILC := 0; -- S := Rs(0); if old S = 0 and S = 1 or S = 0 and old L = 0 and L = 1 then trap => Privilege Error; difference(6..0) := FP - SP(8..2); -- difference is signed, difference(6) = sign bit if difference ≥ 0 then continue at next instruction; -- RET is finished else repeat SP := SP - 4; register SP(7..2)^ := memory SP^; -- memory => local register difference := difference + 1; until difference = 0; </pre>

3.31 Fetch Instruction

The instruction execution is halted until a number of at least $n/2 + 1$ ($n = 0, 2, 4..30$) instruction halfwords succeeding the Fetch instruction are prefetched in the instruction cache. Since instruction words are fetched, one more halfword may be fetched. The number $n/2$ is derived by using bits 4..1 of n , bit 0 of n must be zero.

The Fetch instruction must not be placed as a delay instruction; when the preceding branch is taken, the prefetch is undefined.

The Fetch instruction shares the basic OP-code SET_{xx}, it is differentiated by denoting the SR for the Rd-code (see [section 2.3. Instruction Formats](#)).

n	Format	Notation	Operation
0	Rn	FETCH 1	Wait until 1 instruction halfword is fetched;
.	.	.	.
.	.	.	.
.	.	.	.
30	Rn	FETCH 16	Wait until 16 instruction halfwords are fetched

Note: The Fetch instruction supplements the standard prefetch of instruction words. It may be used to speed up the execution of a sequence of memory instructions by avoiding alternating between instruction and data memory pages. By executing a Fetch instruction preceding a sequence of memory instructions addressing the same data memory page, the memory accesses can be constrained to the data memory page by prefetching all required instructions in advance.

A Fetch instruction may also be used preceding a branch into a program loop; thus, flushing the cache by the first branch repeating the loop can be avoided.

3.32 Extended DSP Instructions

The extended DSP functions use the on-chip multiply-accumulate unit. Single word results always use register G15 as destination register, while double-word results are always placed in G14 and G15. The condition flags remain unchanged.

Format	Notation	Operation
LLext	EMUL Ld, Ls	G15 := Ld * Ls; -- signed or unsigned multiplication, single word product
LLext	EMULU Ld, Ls	G14//G15 := Ld * Ls; -- unsigned multiplication, double word product
LLext	EMULS Ld, Ls	G14//G15 := Ld * Ls; -- signed multiplication, double word product
LLext	EMAC Ld, Ls	G15 := G15 + Ld * Ls; -- signed multiply/add, single word product sum
LLext	EMACD Ld, Ls	G14//G15 := G14//G15 + Ld * Ls; -- signed multiply/add, double word product sum
LLext	EMSUB Ld, Ls	G15 := G15 - Ld * Ls; -- signed multiply/subtract, single word product difference
LLext	EMSUBD Ld, Ls	G14//G15 := G14//G15 - Ld * Ls; -- signed multiply/subtract, double word product difference
LLext	EHMAC Ld, Ls	G15 := G15 + Ld(31..16) * Ls(31..16) + Ld(15..0) * Ls(15..0); -- signed halfword multiply/add, single word product sum
LLext	EHMACD Ld, Ls	G14//G15 := G14//G15 + Ld(31..16) * Ls(31..16) + Ld(15..0) * Ls(15..0); -- signed halfword multiply/add, double word product sum
LLext	EHCMULD Ld, Ls	G14 := Ld(31..16) * Ls(31..16) - Ld(15..0) * Ls(15..0); G15 := Ld(31..16) * Ls(15..0) + Ld(15..0) * Ls(31..16); -- halfword complex multiply
LLext	EHCMACD Ld, Ls	G14 := G14 + Ld(31..16) * Ls(31..16) - Ld(15..0) * Ls(15..0); G15 := G15 + Ld(31..16) * Ls(15..0) + Ld(15..0) * Ls(31..16); -- halfword complex multiply/add
LLext	EHCSUMD Ld, Ls	G14(31..16) := Ld(31..16) + G14; G14(15..0) := Ld(15..0) + G15; G15(31..16) := Ld(31..16) - G14; G15(15..0) := Ld(15..0) - G15; -- halfword (complex) add/subtract -- Ls is not used and should denote the same register as Ld
LLext	EHCFFTD Ld, Ls	G14(31..16) := Ld(31..16) + (G14 >> 15); G14(15..0) := Ld(15..0) + (G15 >> 15); G15(31..16) := Ld(31..16) - (G14 >> 15); G15(15..0) := Ld(15..0) - (G15 >> 15); -- halfword (complex) add/subtract with fixed-point adjustment -- Ls is not used and should denote the same register as Ld

3.32 Extended DSP Instructions (continued)

The instructions EMAC through EHCFFTD can cause an Extended Overflow exception when the Extended Overflow Exception flag is enabled ($\text{FCR}(16) = 0$). Note that this overflow occurs asynchronously to the execution of the Extended DSP instruction and any succeeding instructions.

Attention: A new Extended DSP instruction can be started before the Extended Overflow exception trap is executed!

An Extended DSP instruction is issued in one cycle; the processor starts execution of the next instructions before the Extended DSP instruction is finished. The execution of succeeding non-Extended-DSP instructions is only stopped and wait cycles are inserted when an instruction addresses G15 or G14//G15 respectively before a preceding Extended DSP instruction placed its result into G15 or G14//G15. Thus, DSP programs can place Load/Store or loop administration instructions into the slot cycles between issue of an Extended DSP instruction and availability of its result. See also section [2.5. Instruction Timing](#).

Register

L0 : \$12344321

L1 : \$56788765

G14 : \$11112222

G15 : \$33334444

Instruction

EMUL L0, L1 ; G15 = L0 * L1 = \$4B7CE305

EMULU L0, L1 ; G14//G15 = L0 * L1

; G14 = \$062620AD, G15 = \$4B7CE305

EMAC L0, L1 ; G15 = G15 + L0 * L1 = \$7EB02749

EHCMULD L0, L1 ; G14 = \$25C61D5B

; = L0(31..16)*L1(31..16) - L0(15..0)*L1(15..0)

; G15 = \$0E1927FC

; = L0(31..16)*L1(15..0) + L0(15..0)*L1(31..16)

EHCFFTD L0, L1 ; G14(31..16) = \$3456 = L0(31..16) + (G14>>15)

; = \$06260060

; G14(15..0) = \$A987 = L0(15..0) + (G15>>15)

; = \$06260060

; G15(31..16) = \$F012 = L0(31..16) - (G14>>15)

; = \$06260060

; G15(15..0) = \$DCBB = L0(15..0) - (G15>>15)

; = \$06260060

3.33 Software Instructions

The Software instructions cause a branch to the subprogram associated with each Software instruction. Its entry address (see [section 2.4. Entry Tables](#)), deduced from the OP-code of the Software instruction, is placed in the program counter PC. Data is saved in the register sequence beginning at register address FP + FL (FL = 0 is interpreted as FL = 16) in ascending order as follows:

- i ü Stack address of the destination operand
- i ü High-order word of the source operand
- i ü Low-order word of the source operand
- i ü Old program counter PC, containing the return address and the old S flag in bit zero
- i ü Old status Register SR, ILC contains the instruction-length code (ILC = 1) of the software instruction

Then the frame pointer FP is incremented by the old frame length FL and FL is set to six, thus creating a new stack frame. The cache-mode flag M and the trace-mode flag T are cleared, the interrupt-lock flag L is set to one. All condition flags remain unchanged.

Instruction execution then proceeds at the entry address placed in the PC.

Ls or Lsf and Ld may denote the same register.

Format	Notation	Operation
LL	see specific instructions	$PC := 23 \text{ ones} // 0 // OP(11..8) // 4 \text{ zeros};$ $(FP + FL)^\wedge := \text{stack address of Ld};$ $(FP + FL + 1)^\wedge := Ls;$ $(FP + FL + 2)^\wedge := Lsf;$ $(FP + FL + 3)^\wedge := \text{old PC}(31..1) // \text{old S};$ $(FP + FL + 4)^\wedge := \text{old SR};$ $FP := FP + FL; \quad \text{-- FL = 0 is treated as FL = 16}$ $FL := 6;$ $M := 0;$ $T := 0;$ $L := 1;$

Note: At the new stack frame, the stack address of the destination operand can be addressed as L0, the source operand as L1//L2, the saved PC as L3 and the saved SR as L4; L5 is free for use as required.

A Frame instruction must be executed before executing any other Software instruction, Trap or Call instruction or before the interrupt-lock flag L is being cleared, otherwise the beginning of the register part of the stack at SP could be overwritten without any warning.

3.33.1 Do Instruction

The Do instruction is executed as a Software instruction. The associated subprogram is entered, the stack address of the destination operand and one double-word source operand are passed to it (see [section 3.33. Software Instructions](#) for details).

The halfword succeeding the Do instruction will be used by the associated subprogram to differentiate branches to subordinate routines; the associated subprogram must increment the saved return program counter PC by two.

Format	Notation	Operation
LL	DO xx... Ld, Ls	execute Software instruction;

"xx..." stands for the mnemonic of the differentiating halfword after the OP-code of the Do instruction.

The Do instruction must not be placed as delay instruction since then xx... cannot be located.

Note: The Do instruction provides very code efficient passing of parameters to routines executing software implemented extensions of the instruction set.

Branching to unimplemented subordinate routines with the interrupt-lock flag L set to one must be excluded by bound checks of the differentiating halfword at runtime; out-of-range values cannot be securely excluded at the assembly level.

The L flag must be cleared when the execution of a subordinate routine exceeds the regular interrupt latency time.

Application Note: The definition of subprograms entered via the Do instruction is reserved for system implementations. The values assigned to the differentiating halfword xx... after the OP-code of the Do instruction must be in ascending and contiguous order, starting with zero. This order enables fast range checking for an upper bound and also avoids unused space in the differentiating branch table.

3.33.2 Floating-Point Instructions

The Floating-Point instructions comply with the ANSI/IEEE standard 754-1985. In the present version, they are executed as Software instructions. The following description provides a general overview of the architectural integration.

The basic instructions use single-precision (single-word) and double-precision (double-word) operands. Floating-Point instructions must not be placed as delay instructions (see 3.26. Delayed Branch Instructions).

Except at the Floating-Point Compare instructions, all condition flags remain unchanged to allow future concurrent execution.

The rounding modes FRM are encoded as:

SR(14)	SR(13)	Description
0	0	Round to nearest
0	1	Round toward zero
1	0	Round toward - infinity
1	1	Round toward + infinity

The floating-point trap enable flags FTE and the exception flags are assigned as:

floating-point trap enable FTE	accrued exceptions	actual exceptions	exception type
SR(12)	G2(4)	G2(12)	Invalid Operation
SR(11)	G2(3)	G2(11)	Division by Zero
SR(10)	G2(2)	G2(10)	Overflow
SR(9)	G2(1)	G2(9)	Underflow
SR(8)	G2(0)	G2(8)	Inexact

The reserved bits G2(31..13) and G2(7..5) must be zero.

A floating-point Not a Number (NaN) is encoded by bits 30..19 = all ones in the operand word containing the exponent; all other bits of the operand are ignored for differentiating a NaN from a non-NaN.

In the case of an operand word containing a NaN, bit zero = 0 differentiates a quiet NaN, bit zero = 1 differentiates a signaling NaN; the bits 18..1 may be used to encode further information.

3.33.2 Floating-Point Instructions (continued)

The floating-point instruction supports the five IEEE standard 754-1985 exceptions:

- Inexact (I)
- Overflow (O)
- Underflow (U)
- Division by Zero (Z)
- Invalid Operation (V)

The following sections describe the conditions that cause the floating-point instruction to generate each of its exceptions and the details the floating-point instruction response to each exception-causing situation.

Inexact Exception (I)

The floating-point instruction generates the Inexact exception if the result of an operation is not exact or if it overflows.

Floating-point Trap Enabled Results: If Inexact exception traps are enabled, the result register is not modified and the source registers are preserve.

Floating-point Trap Disabled Results: The rounded or overflowed result is delivered to the destination register if no other software trap occurs.

Overflow Exception (O)

The Overflow exception is signaled when the magnitude of the rounded floating-point result, if the exponent range were to be unbounded, is larger than the destination format's largest finite number. (This exception also sets the Inexact exception and Flag bits.)

Floating-point Trap Enabled Results: The result register is not modified, and the source registers are preserved.

Floating-point Trap Disabled Results: The result, when no trap occurs, is determined by the rounding mode and the sign of the intermediate result.

Division by Zero (Z)

The Division by Zero exception is signaled on and implemented divide operation if the divisor is zero and the dividend is a finite non-zero number. Software can simulate this exception for other operations that produce a signed infinity, such as $\ln(0)$, $\sec(\pi/2)$, $\csc(0)$, or 0^{-1} .

Floating-point Trap Enabled Results: The result register is not modified, and the source register are preserved.

Floating-point Trap Disabled Results: The result, when no trap occurs, is a correctly signed infinity.

3.33.2 Floating-Point Instructions (continued)

Invalid Operation Exception (V)

The Invalid Operation exception is signaled if one or both of the operand are invalid for an implemented operations. The MIPS ISA defines the result, when the exception occurs without a trap, as a quiet Not a Number (NaN). The invalid operations are:

- Addition or subtraction: magnitude subtraction of infinities, such as: (+inf) + (-inf) or (-inf) - (-inf)
- Multiplication: 0 times +inf, with any signs.
- Division: 0/0, or inf/inf, with any signs.
- Conversion of a floating-point number to a fixed-point format when an overflow, or operand value of infinity or NaN, precludes a faithful representation in that format.
- Comparison of predicates involving < or > without ?, when the operands are unordered.
- Any arithmetic operation on a signaling NaN. A move (MOV) operation is not considered to be an arithmetic operation, but absolute value (ABS) and negate (NEG) are considered to be arithmetic operations and cause this exception if one or both operands is a signaling NaN.
- Square root: sqrt(x), where x is less than zero.

Floating-point Trap Enabled Results: The original operand values are undisturbed.

Floating-point Trap Disabled Results: The FPU always signals an Unimplemented exception because it does not create the NaN that the IEEE standard specifies should be returned these circumstances.

Underflow Exception (U)

Two related events contribute to the Underflow exception:

- The creation of a tiny non-zero result between $+2^{E_{min}}$ and $-2^{E_{min}}$ that can cause some later exception because it is so tiny.
- The extraordinary loss of accuracy during the approximation of such tiny numbers by demoralized numbers.

Floating-point Trap Enabled Results: When an underflow trap is enabled, underflow is signaled when tininess is detected regardless of loss of accuracy. If underflow traps are enabled, the result register is not modified, and the source registers are preserved.

Floating-point Trap Disabled Results: When an underflow trap is not enabled, underflow is signaled (using the underflow flag) only when both tininess and loss of accuracy have been detected. The delivered result might be zero, demoralized, or $+2^{E_{min}}$ and $-2^{E_{min}}$.

3.33.2 Floating-Point Instructions (continued)

Format	Notation	Operation
LL	FADD Ld, Ls	$Ld := Ld + Ls;$
LL	FADDD Ld, Ls	$Ld//Ldf := (Ld//Ldf) + (Ls//Lsf);$
LL	FSUB Ld, Ls	$Ld := Ld - Ls;$
LL	FSUBD Ld, Ls	$Ld//Ldf := (Ld//Ldf) - (Ls//Lsf);$
LL	FMUL Ld, Ls	$Ld := Ld * Ls;$
LL	FMULD Ld, Ls	$Ld//Ldf := (Ld//Ldf) * (Ls//Lsf);$
LL	FDIV Ld, Ls	$Ld := Ld / Ls;$
LL	FDIVD Ld, Ls	$Ld//Ldf := (Ld//Ldf) / (Ls//Lsf);$
LL	FCVT Ld, Ls	$Ld := Ls//Lsf;$ -- Convert double \Rightarrow single
LL	FCVTD Ld, Ls	$Ld//Ldf := Ls;$ -- Convert single \Rightarrow double
LL	FCMP Ld, Ls	$result := Ld - Ls;$ $Z := Ld = Ls$ and not unordered; $N := Ld < Ls$ or unordered; $C := Ld < Ls$ and not unordered; $V :=$ unordered; if unordered then Invalid Operation exception;
LL	FCMPD Ld, Ls	$result := (Ld//Ldf) - (Ls//Lsf);$ $Z := (Ld//Ldf) = (Ls//Lsf)$ and not unordered; $N := (Ld//Ldf) < (Ls//Lsf)$ or unordered; $C := (Ld//Ldf) < (Ls//Lsf)$ and not unordered; $V :=$ unordered; if unordered then Invalid Operation exception;
LL	FCMPU Ld, Ls	$result := Ld - Ls;$ $Z := Ld = Ls$ and not unordered; $N := Ld < Ls$ or unordered; $C := Ld < Ls$ and not unordered; $V :=$ unordered; -- no exception
LL	FCMPUD Ld, Ls	$result := (Ld//Ldf) - (Ls//Lsf);$ $Z := (Ld//Ldf) = (Ls//Lsf)$ and not unordered; $N := (Ld//Ldf) < (Ls//Lsf)$ or unordered; $C := (Ld//Ldf) < (Ls//Lsf)$ and not unordered; $V :=$ unordered; -- no exception

3.33.2 Floating-Point Instructions (continued)

A floating-point instruction, except a Floating-point Compare, can raise any of the exceptions Invalid Operation, Division by Zero, Overflow, Underflow or Inexact. FCMP and FCMPD can raise only the Invalid Operation exception (at unordered). FCMPU and FCMPUD cannot raise any exception.

At an exception, the following additional action is performed:

- i ü Any corresponding accrued-exception flag whose corresponding trap-enable flag is zero (not enabled) is set to one; all other accrued-exception flags remain unchanged.
- i ü If a corresponding trap-enable flag is one (enabled), any corresponding actual-exception flag is set to one; all other actual-exception flags are cleared. The destination remains unchanged.

In the present software version, the software emulation routine must branch to the corresponding user-supplied exception trap handler. The (modified) result, the source operand, the stack address of the destination operand and the address of the floating-point instruction are passed to the trap handler. In the future hardware version, a trap to Range Error will occur; the Range Error handler will then initiate re-execution of the floating-point instruction by branching to the entry of the corresponding software emulation routine, which will then act as described before.

The only exceptions that can coincide are Inexact with Overflow and Inexact with Underflow. An Overflow or Underflow trap, if enabled, takes precedence over an Inexact trap; the Inexact accrued-exception flag G2(0) must then be set as well.

3.33.2 Floating-Point Instructions (continued)

The table below shows the combinations of Floating-Point Compare and Branch instructions to test all 14 floating-point relations:

relation	Compare	Branch on true	Branch on false	exception if unordered
=	FCMPU	BE	BNE	--
?≠	FCMPU	BNE	BE	--
>	FCMP	BGT	BLE	x
≥	FCMP	BGE	BLT	x
<	FCMP	BLT	BGE	x
≤	FCMP	BLE	BGT	x
?	FCMPU	BV	BNV	--
≠	FCMP	BNE	BE	x
<=>	FCMP	--	--	x
?>	FCMPU	BHT	BSE	--
?≥	FCMPU	BHE	BST	--
?<	FCMPU	BLT	BGE	--
?≤	FCMPU	BLE	BGT	--
?=	FCMPU	BE, BV	BST, BGT	--

The symbol ? signifies unordered.

Note: At the test <=> (ordered), no branch after FCMP is required since the result of the test is an Invalid Operation exception occurred or not occurred.

4. Exceptions

4.1 Exception Processing

Exceptions and interrupts are events other than branches or jumps that change the normal flow of instruction execution. An exception is an unexpected event from within the processor, arithmetic overflow is an example of an exception. An interrupt is an event that also cause an unexpected change in control flow but comes from outside of the processor. Interrupts are used by I/O devices to communicate with the processor.

Exceptions are events that redirect the flow of control to a supervisor subprogram associated with the type of exception, that is, a trap occurs as a response to the exception. (See a detailed description of exceptions further below.) If exceptions coincide, the exception with the highest priority takes precedence over all exceptions with lower priority.

Processing of an exception proceeds as follows:

The entry address (see section 2.4. [Entry Tables](#)) of the associated subprogram is placed in the program counter PC and the supervisor-state flag S is set to one. The old PC is saved in the register addressed by FP + FL; the old S flag is also saved in bit zero of this register. The old status register SR is saved in the register addressed by FP + FL + 1 (FL = 0 is interpreted as FL = 16); the saved instruction-length code ILC contains (in general, see section 4.3. [Exception Backtracking](#)) the instruction-length code of the preceding instruction.

Then the frame pointer FP is incremented by the old frame length FL and FL is set to two, thus creating a new stack frame. The cache-mode flag M and the trace-mode flag T are cleared, the interrupt-lock flag L is set to one. All condition flags remain unchanged.

Operation

```

PC := entry address of exception subprogram;
S := 1;
(FP + FL)^ := old PC(31..1)//old S;
(FP + FL + 1)^ := old SR;
FP := FP + FL;           -- FL = 0 is treated as FL = 16
FL := 2;
M := 0;
T := 0;
L := 1;

```

Note: At the new stack frame, the saved PC can be addressed as L0 and the saved SR as L1. Since FL = 2, no other local registers are free for use.

A Frame instruction must be executed before the interrupt-lock flag L is cleared, before any Call, Trap, Software instruction or any instruction with the potential to cause an exception is executed. Otherwise, the beginning of the register part of the stack at the SP could be overwritten without any warning.

An entry caused by an exception can be differentiated from an entry caused by a Trap instruction by the value of FL: FL is set to two by an exception and set to six by a Trap instruction.

4.2 Exception Types

The following exception are types ordered by priorities, Reset has the highest priority. In case of coincidental exceptions, higher-priority exceptions overrule lower-priority exceptions.

4.2.1 Reset

A Reset exception occurs on a transition of the RESET# signal from low to high or as a result of a watchdog overrun. It overrules all other exceptions and is used to start execution at the Reset entry.

The load and store pipelines are cleared and all bits of the BCR, FCR and MCR are set to one; all other registers and flags, except those set or cleared explicitly by the exception processing itself, remain undefined and must be initialized by software.

Note: The frame pointer FP can only be set to a defined value by restoring it from the FP in the return SR through a Return instruction.

4.2.2 Range, Pointer, Frame and Privilege Error

These exceptions share a common entry since they cannot occur coincidentally at the same instruction. The error-causing instruction can be identified by backtracking.

A Range Error exception occurs when an operand or result exceeds its value range.

A Pointer Error is caused by an attempted memory access using an address register (Rd or Ld) with the content zero. The memory is not accessed, but the content of the address register is updated in case of a post-increment or next address mode.

A Frame Error occurs when the restructuring of the stack frame reaches or exceeds the upper bound UB of the memory part of the stack. No further Frame instruction must be executed by the error routine for Pointer, Frame and Privilege Error before the UB is set to a higher value and thus, an expanded stack frame fits into the higher stack bound.

A Privilege Error occurs when a privileged operation is executed in user or on return to user state (see section [1.5. Privilege States](#) for details).

4.2.3 Extended Overflow

An Extended Overflow condition is raised on an overflow caused by an add or subtract operation as part of the execution of one of the Extended instructions EMAC through EHCFFTD when the Extended Overflow exception is enabled. The Extended Overflow exception is enabled by clearing bit 16 of the function control register FCR to zero.

When the Extended Overflow exception is blocked by a higher-priority exception or by the L flag being set, the Extended Overflow condition is saved internally; the exception trap occurs then when the blocking is released.

The Extended Overflow condition is cleared by the exception trap or by setting FCR(16) to one (disabled).

4.2.3 Extended Overflow (continued)

The Extended Overflow exception trap occurs asynchronously to the causing instruction; thus, the causing instruction cannot be identified by backtracking. Usually, there is only one instruction in a loop that can cause an Extended Overflow exception; thus, a handler can identify that instruction. When a second Extended Overflow condition is raised before the first one caused a trap, it is ored and only one trap is taken.

4.2.4 Parity Error

A Parity Error exception can be enabled individually for each of the memory areas MEM0..MEM3. When enabled, a parity error on an access to the corresponding memory area causes a Parity Error exception.

When the Parity Error exception is blocked by a higher-priority exception or by the L flag being set, the Parity Error condition is saved internally, the exception trap occurs then when the blocking is released.

The Parity Error condition is cleared only by the exception trap; it is not cleared by setting any of the disable bits 31..28 in the BCR after a Parity Error condition is saved internally.

The Parity Error exception trap occurs asynchronously to the causing memory instruction. Since memory accesses are pipelined, a Parity Error exception cannot be related to a specific memory instruction.

4.2.5 Interrupt

An Interrupt exception is caused by an external interrupt signal, by the timer interrupt or by an IO3 Control Mode. Since the interrupt-lock flag L is set by the exception processing, no further interrupts can occur until the L flag is cleared. The interrupt exception processing sets also the interrupt-mode flag I to one. See also sections [2.4. Entry Tables](#), [5. Timer](#) and [6.9. Bus Signals](#).

The I flag is used by the operating system, it must not be cleared by the interrupt handler. A Return instruction restores the old value from the saved SR automatically.

4.2.6 Trace Exception

A Trace exception occurs after each execution of an instruction except a Delayed Branch instruction when the trace mode is enabled (trace flag T = 1) and the trace pending flag P is one. After a Call instruction, a Trace exception is suppressed until the next instruction is executed regardless of the trace mode being enabled; the T flag is not affected.

The P flag in the saved return status register SR must be cleared by the trace handler to prevent tracing the same instruction again.

The instruction preceding the Trace exception cannot be backtracked since only potentially error-causing instructions can and need be backtracked.

4.3 Exception Backtracking

In the case of a Pointer, Frame, Privilege and Range Error exception caused by a delay instruction succeeding a delayed branch taken, the location of the saved PC contains the address of the delay instruction and the saved instruction length code ILC contains the length of the Delayed Branch instruction (in halfwords).

In the case of all other exceptions, the location of the saved PC contains the return address, that is, the address of the instruction that would have been executed next if the exception had not occurred. The saved ILC contains the length of the last instruction except when the last instruction executed was a branch taken; a Return instruction clears the ILC and thus, the saved ILC after a Return instruction contains zero.

An exception caused by a Pointer, Frame, Privilege or Range Error, except following a Return instruction, can be backtracked. For backtracking, the content of the adjusted saved ILC is subtracted from the address contained in the location of the saved PC.

If the backtrack-address calculated in this way points to a Delayed Branch instruction, the error-causing instruction is a delay instruction with a preceding delayed branch taken and the address contained in the location of the saved PC points to the address of this delay instruction.

If the backtrack-address calculated does not point to a Delayed Branch instruction, it points directly to the error-causing instruction. This instruction is then either not a delay instruction or a delay instruction with the preceding delayed branch not taken.

The error-causing instruction can then be inspected and the cause of an error analyzed in detail.

In the case of a Privilege Error, the ILC must be tested for zero to single out an exception caused by a Return instruction before backtracking. Thus, an exception caused by a Return instruction can be identified. However, it cannot be backtracked to the instruction address of the Return instruction because the return address saved does not succeed the address of the Return instruction. All other branching instructions cannot be backtracked either. Since these instructions cause no errors, backtracking is not required.

The stack address of a local register denoted by a backtracked instruction can be calculated according to the following formula:

```

stack address of preceding stack frame := stack address of
current stack frame - (((FP - saved FP) modulo 64) * 4);
-- bits 5..0 of the difference (FP - saved FP) are used zero-expanded
-- * 4 converts word difference => byte difference
-- the stack address of the current stack frame is provided by the
Set Stack Address instruction
stack address of local register := stack address of preceding
stack frame + (local register address code * 4);
-- * 4 converts local register word offset => byte offset

```

Note: Backtracking allows a much more detailed analysis of error causes than a more differentiated trapping could provide. Exception handlers can get more information about error causes and the precise messages required by most programming languages can be easily generated.

5. Timer

5.1 Overview

The on-chip timer is controlled via three registers:

Timer prescaler register TPR	G21
Timer register TR	G23
Timer compare register TCR	G22

G21..G23 can be addressed only via the high global flag H by a MOV or MOVI instruction. The content of G21 (timer prescaler register) cannot be read.

The write-only TPR sets a carry flag C (overflow) when the value of the counter in TPR equals to the content of TR, and transfers carry flag C to the TR. When the TPR transfers carry flag to the TR, TR increments by one on modulo 2^{32} . Timer clock frequency is determined by the content of TPR.

When the TR is higher than or equals to the TCR, the timer interrupt is generated.

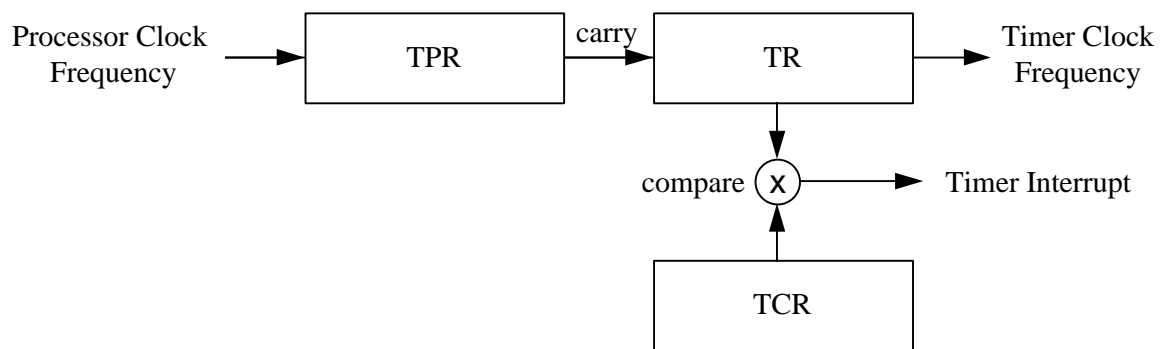

Fig. 5.1 The block diagram of on-chip timer.

5.1.1 Timer Prescaler Register TPR

The write-only TPR adapts the timer clock to different processor clock frequencies. Only bit positions 23..16 are used, all other bits are reserved and must be zero on a move to the TPR.

The TPR operates from the processor clock input CLKIN and divides the processor clock according to:

$$\text{frequency of timer clock} := \text{frequency of processor clock} \text{ divided by } (n+2)$$

n is the value to be loaded into the TPR at the bit positions 23..16, it is calculated according to the formula:

$$n = (\text{time unit} * \text{frequency of processor clock}) - 2$$

time unit is the basic time interval for the timer operation (time unit := 1 / frequency of timer clock). n must be in the range of 2..255.

5.1.2 Timer Register TR

The TR is a 32-bit register that is incremented by one on each time unit modulo 2^{32} . Its content can be used as the lower word of a double-word integer, representing the time inclusive date.

The TPR and the TR should be set only once on system initialization, whereby the following instruction sequence must be observed strictly (interrupts must be locked out):

```

:
:
FETCH 4
ORI  SR, $20      ; set H-flag
MOV  TPR, Lx      ; load prescaler register from local register x
ORI  SR, $20      ; set H-flag
MOV  TR, Ly       ; load timer register from local register y
:
:

```

Note: The Fetch instruction is necessary to prevent insertion of idle cycles during the prescribed instruction sequence.

5.1.3 Timer Compare Register TCR

The content of the TCR is compared continuously with the content of the timer register TR. An unsigned modulo comparison is performed according to:

$$\text{result}(31..0) := \text{TR}(31..0) - \text{TCR}(31..0)$$

On $\text{result}(31) = 0$, the TR is higher than or equal to the TCR.

When the timer interrupt is enabled ($\text{FCR}(23) = 0$) and the value in the TR is higher than or equal to the value in the TCR, a timer interrupt is generated. This interrupt is cleared by loading the TCR with a value higher than the current content of the TR.

Timer interrupts can be masked out by $\text{FCR}(23) = 1$; $\text{FCR}(23)$ is set to one on Reset. The timer interrupt disable bit $\text{FCR}(23)$ does not affect the timer and compare function.

A delay time in the TCR is calculated according to the formula:

$$\text{TCR} := \text{current content of TR} + \text{number of delay time units}$$

The maximum number of delay time units allowed for this calculation is $2^{31}-1$.

For example:

$$\begin{aligned} \text{TR}(31..0) &= \text{hex FFFF FF00} \\ \text{delay time units (= 1000)} &= \text{hex 0000 03E8} \\ \text{TCR}(31..0) &= \text{hex 0000 02E8} \end{aligned}$$

Since the modulo comparison is an unsigned operation, only unsigned arithmetic must be used for calculations with timer and timer compare values. Do not use the N or C flag to test for the result of the comparison $\text{TR} - \text{TCR}$, use only result bit 31!

6. Bus Interface

6.1 Bus Control General

The processor provides on-chip all functions for controlling memory and peripheral devices, including RAS-CAS multiplexing, DRAM refresh and parity generation and checking. The number of bus cycles used for a memory or I/O access is also defined by the processor, thus, no external bus controllers are required. All memory and peripheral devices can be connected directly, pin by pin, without any glue logic.

The memory address space is divided into five partitions as follows:

Address (hex)	Address Space	Memory Type
0000 0000..3FFF FFFF	Address Space MEM0	ROM, SRAM, DRAM
4000 0000..7FFF FFFF	Address Space MEM1	ROM, SRAM
8000 0000..BFFF FFFF	Address Space MEM2	ROM, SRAM
C000 0000..DFFF FFFF	Address Space IRAM	Internal RAM (IRAM)
E000 0000..FFFF FFFF	Address Space MEM3	ROM, SRAM

Table 6.1: Memory Address Spaces

The bus timing, refresh control and parity error disable for memory access is defined in the bus control register BCR. The bus timing for I/O access is defined by address bits in the I/O address.

On a memory or I/O access, the address bus signals are valid through the whole access. On a memory access, the chip select signal for the selected memory area MEM0..MEM3 is switched to low (active low) through the whole access. On a write access to memory or I/O, the data bus and the parity signals are also activated and the write enable signal WE# is switched to low through the whole access.

A bus wait cycle is inserted automatically to guarantee a minimum of one idle cycle between the end of an output enable signal (OE#, IORD#, CASx# at read) and the beginning of a subsequent write access. After a DRAM read access with an access time > 2 cycles, an additional bus wait cycle is inserted.

6.1.1 SRAM and ROM Bus Access

On a one-cycle SRAM or EPROM read access, the output enable signal OE# is switched to low during the second half of the access cycle; on a multi-cycle read access, OE# is switched to low after the first access cycle and remains low through the rest of the specified access cycles. On a SRAM write access, the write enable signals WE0#..WE3# corresponding to the bytes to be written are switched to low analogous to the OE# signal for single and multiple access cycles.

For memory area MEM2, an address setup cycle preceding the access cycles can be specified. For MEM0..MEM3, bus hold cycles can be specified. Bus hold cycles are additional cycles succeeding the access cycles where neither OE# nor WE0#..WE3# is low but all other bus signals are asserted. The bus hold cycles can be specified to be skipped or enforced. (see section [6.4.7. MEMx Bus Hold Break](#)).

6.1.1.1 SRAM and ROM Single-Cycle Read Access

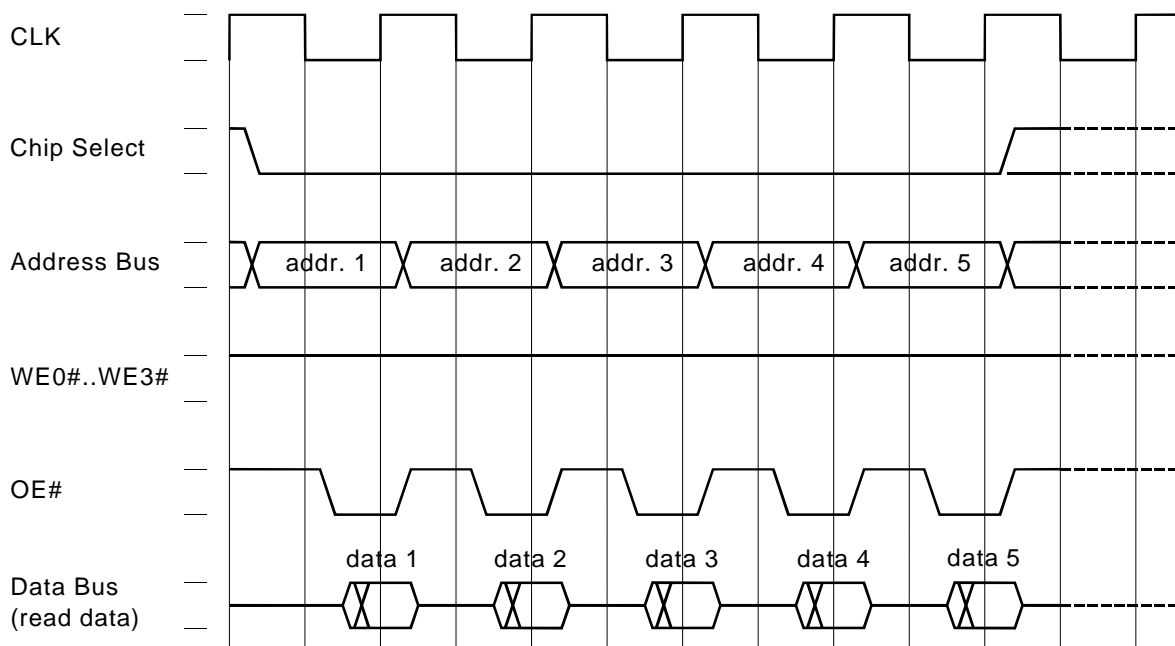

Figure 6.1: SRAM and ROM Single-Cycle Read Access

6.1.1.2 SRAM and ROM Multi-Cycle Read Access

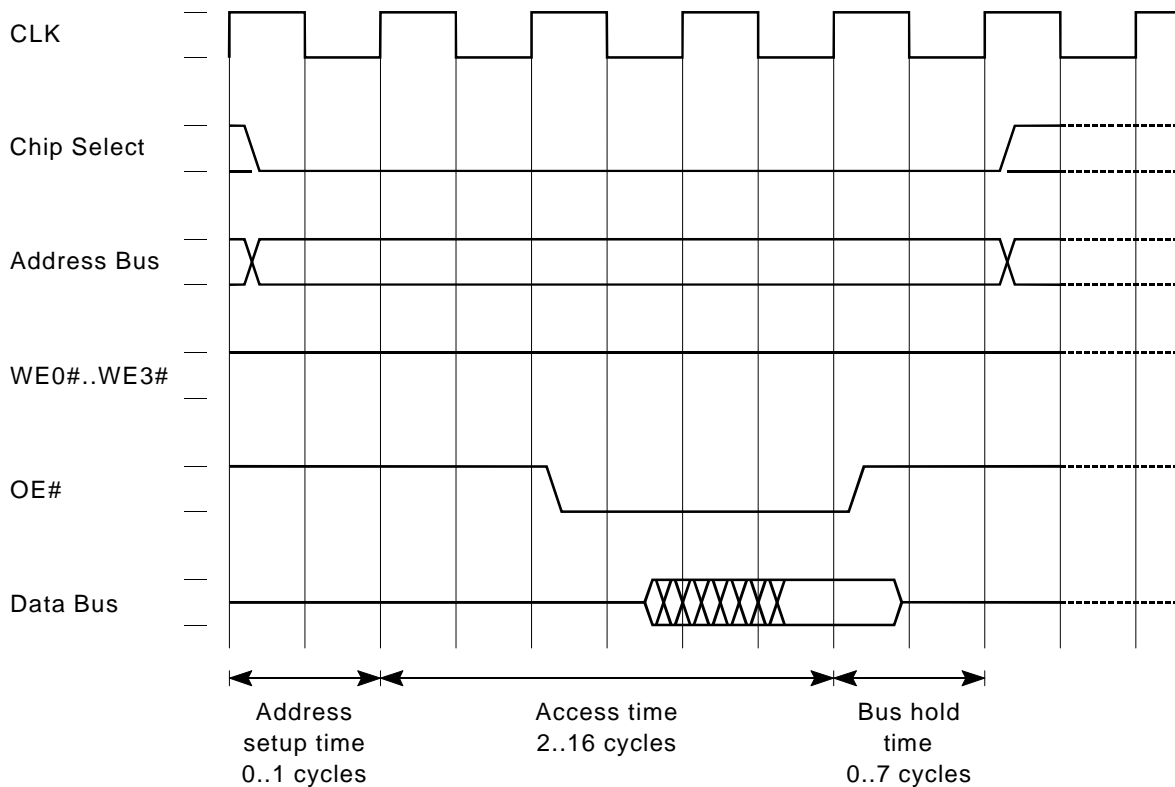

Figure 6.2: SRAM and ROM Multi-Cycle Read Access

6.1.1.3 SRAM Single-Cycle Write Access

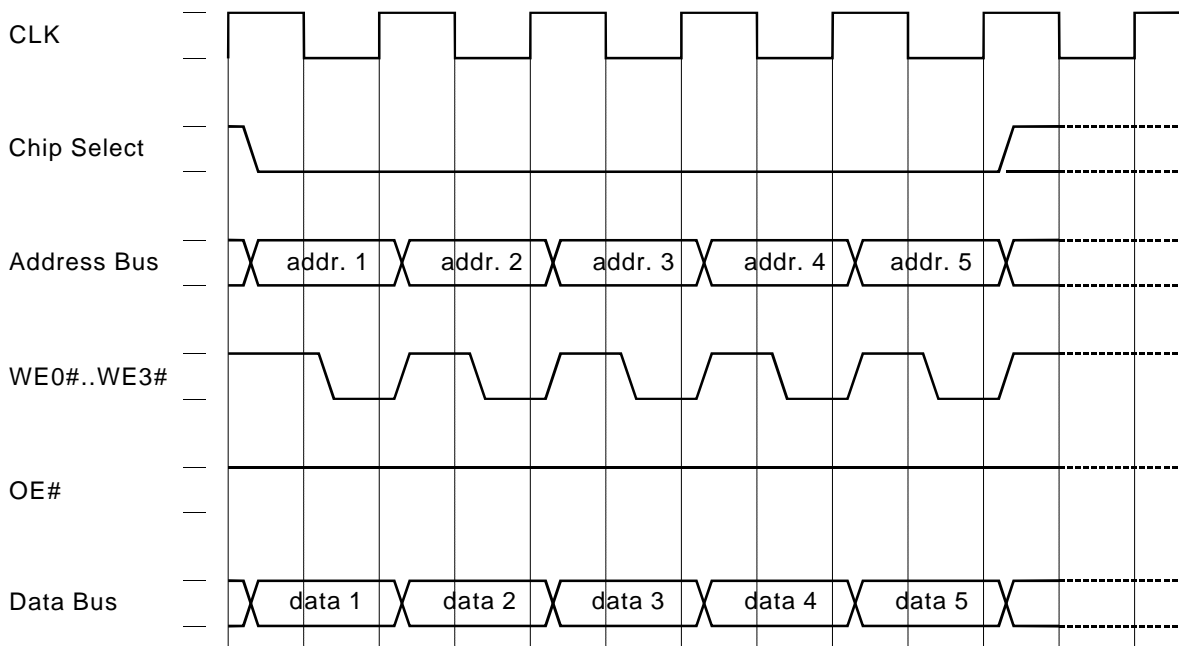

Figure 6.3: SRAM Single-Cycle Write Access

6.1.1.4 SRAM Multi-Cycle Write Access

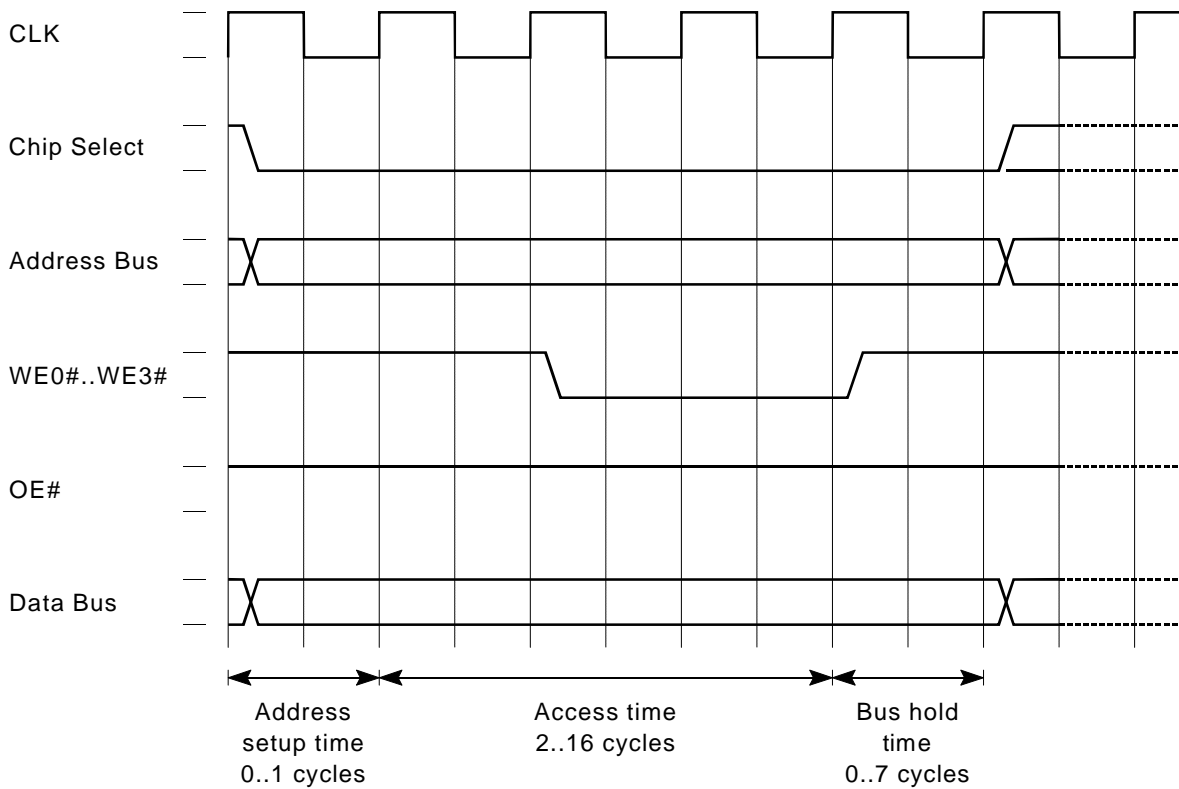

Figure 6.4: SRAM Multi-Cycle Write Access

6.1.2 DRAM Bus Access

A DRAM access to the same DRAM page as addressed by the previous DRAM access is executed as fast page mode access. See bus control register BCR(17..16) for the access time and low-cycles of the CASx# signals. CAS0#..CAS3# signals enable the corresponding memory bytes 0..3.

A RAS access occurs when the DRAM page is different from the previously accessed DRAM page. The RAS# signal is switched to high for the number of specified precharge cycles. The high-order row address bits are multiplexed to the bit positions of the low-order column address bits according to the specified page size after the first bus cycle until the end of the specified RAS-to-CAS delay cycles. After the RAS-to-CAS delay cycles, the column address bits are available on the low-order bit positions and the CAS access cycle begins.

The row address bits are available at the high-order bit positions for the whole DRAM access. After a DRAM access, the addressed DRAM page is being available for fast page mode accesses to the same page until either a new DRAM page is addressed, the processor is released to another bus master for DMA or a DRAM refresh takes place.

Note: The multiplexed row address bits are not in any specific order.

DRAM Read and Write Cycle

(1) Write Cycle

Active word line → TR: ON → Load stored data to
bit line → Data write

(2) Read Cycle

Apply $V_{DD}/2$ to bit line → Active word line → Read data
stored in capacitor

(3) Refresh (CAS before RAS)

CAS before RAS signal → Enter refresh mode → Store
original data to sense amplifier → Active word line → Refresh (data write)

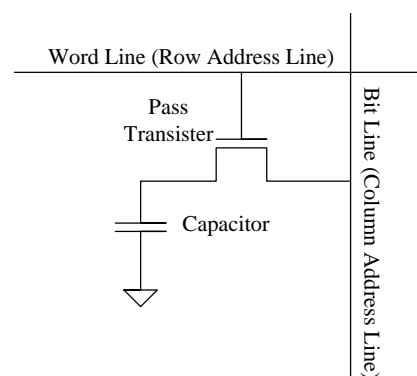

6.1.2.1 DRAM Access

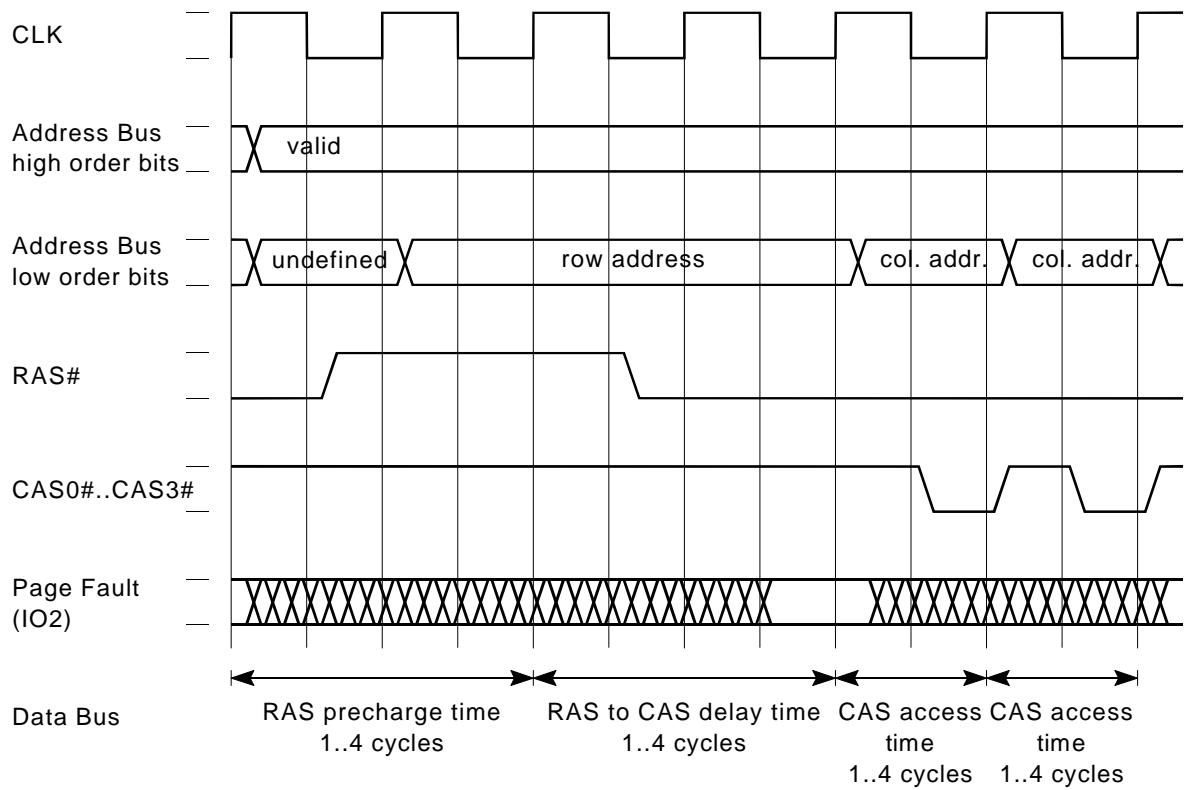

at read access

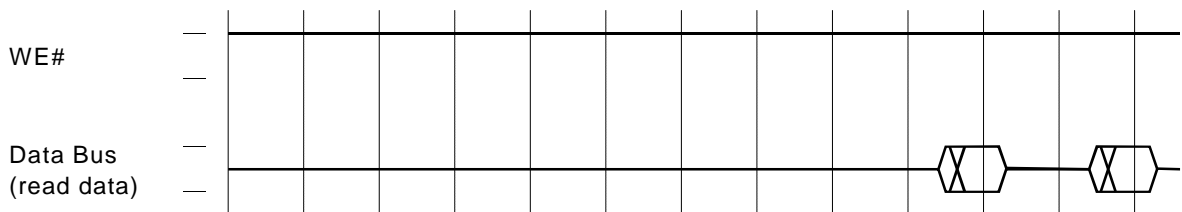

at write access

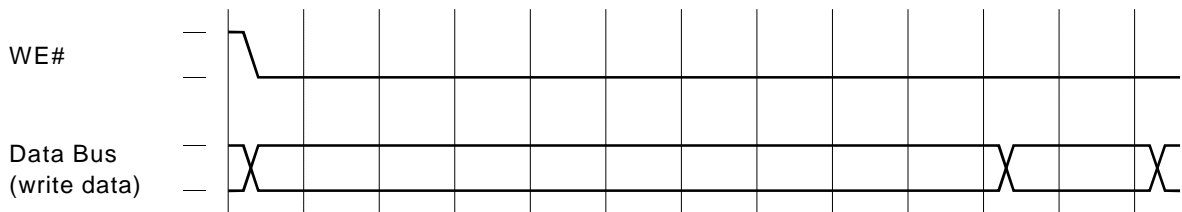

Figure 6.5: DRAM Access

Note: The window for PGFLT acceptance is the last cycle of the RAS-to-CAS delay time.

6.1.2.2 DRAM Refresh (CAS before RAS Refresh)

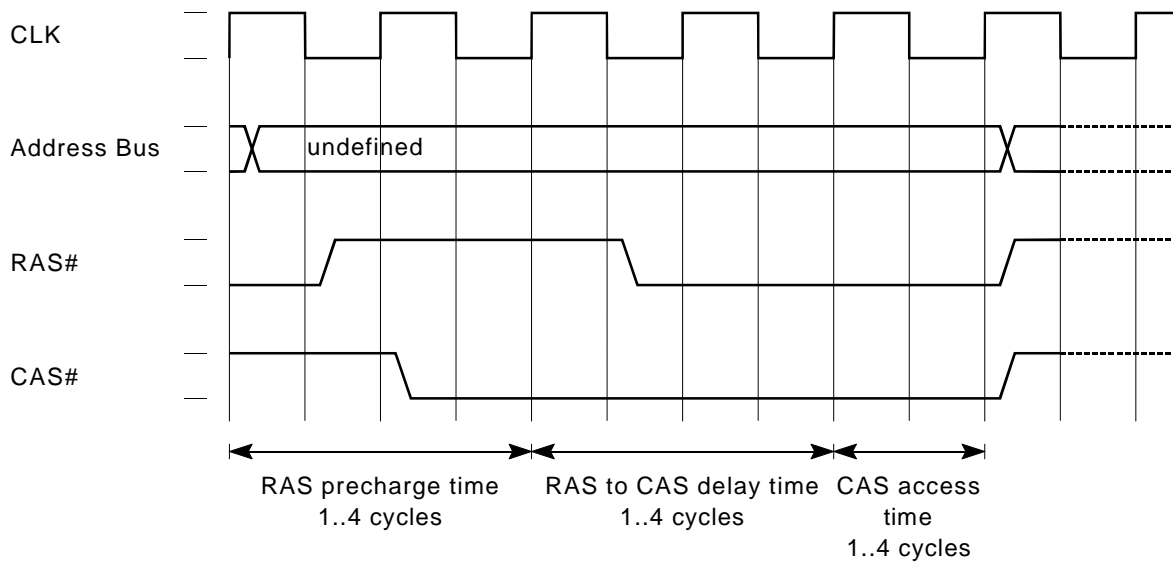
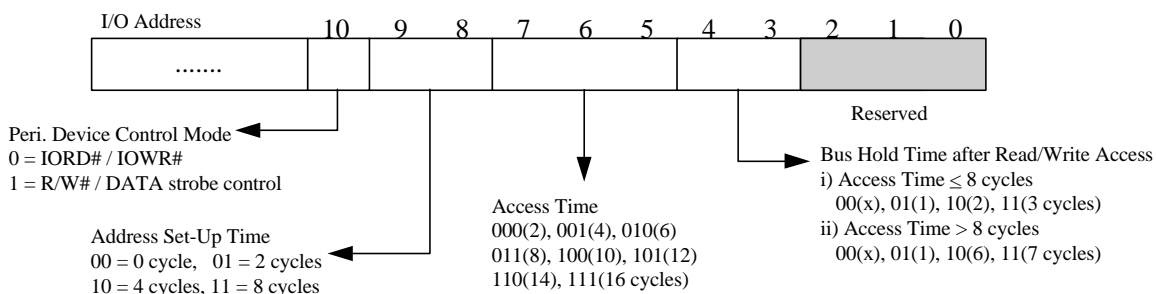

Figure 6.6: DRAM Refresh

6.1.3 I/O Bus Access

The bus timing for an I/O access is specified by bits 10..3 of the I/O address.



On an I/O access, the I/O read strobe IORD# or the I/O write strobe IOWR# is switched low for a read or write access respectively after the first access cycle and remains low for the rest of the specified access cycles. The beginning of the IORD# or IOWR# signal can be delayed by more than one cycle by specifying additional address setup cycles preceding the access cycles. The beginning of the next bus access can be delayed by specifying bus hold cycles succeeding the access cycles. Bus hold cycles are required by many I/O devices due to the time required to switch from driving the data bus to three-state.

When an I/O device requires R/W# direction and data strobe control, IORD# can be specified (by address bit 10 = 1) as data strobe. WE# is then used as R/W# signal.

6.1.3.1 I/O Read Access

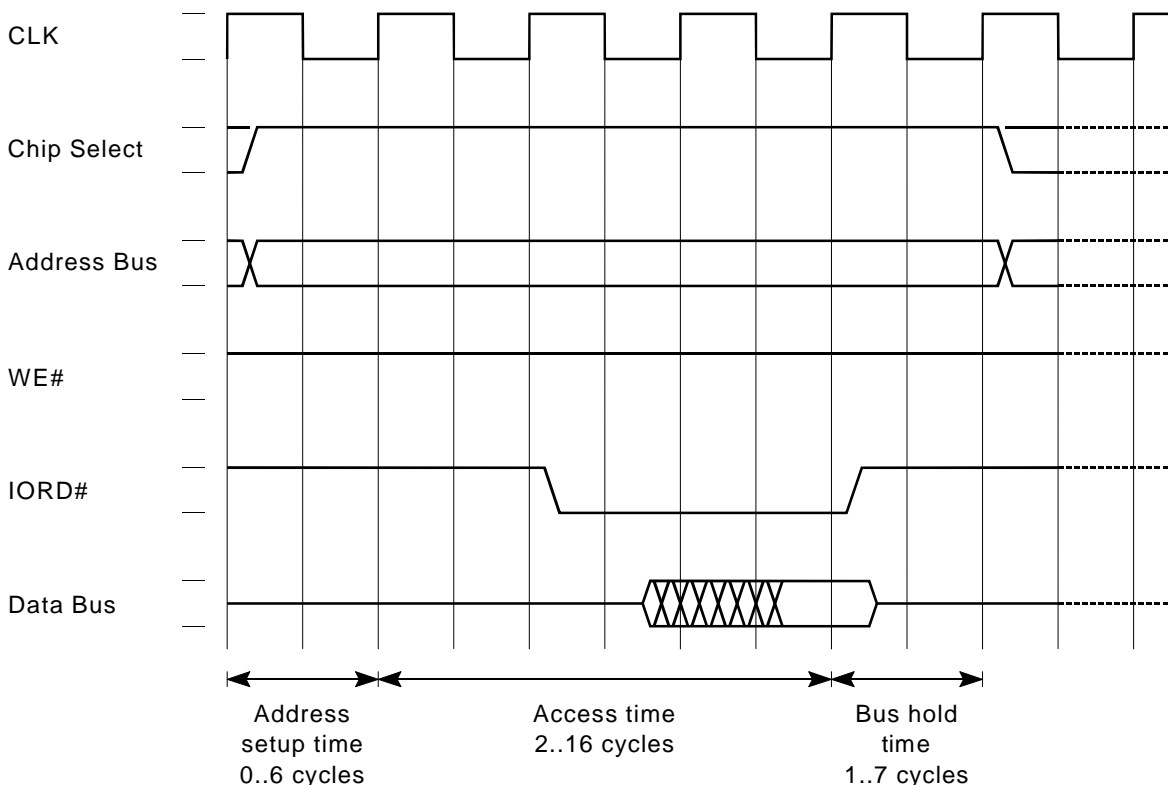

Figure 6.7: I/O Read Access

6.1.3.2 I/O Write Access

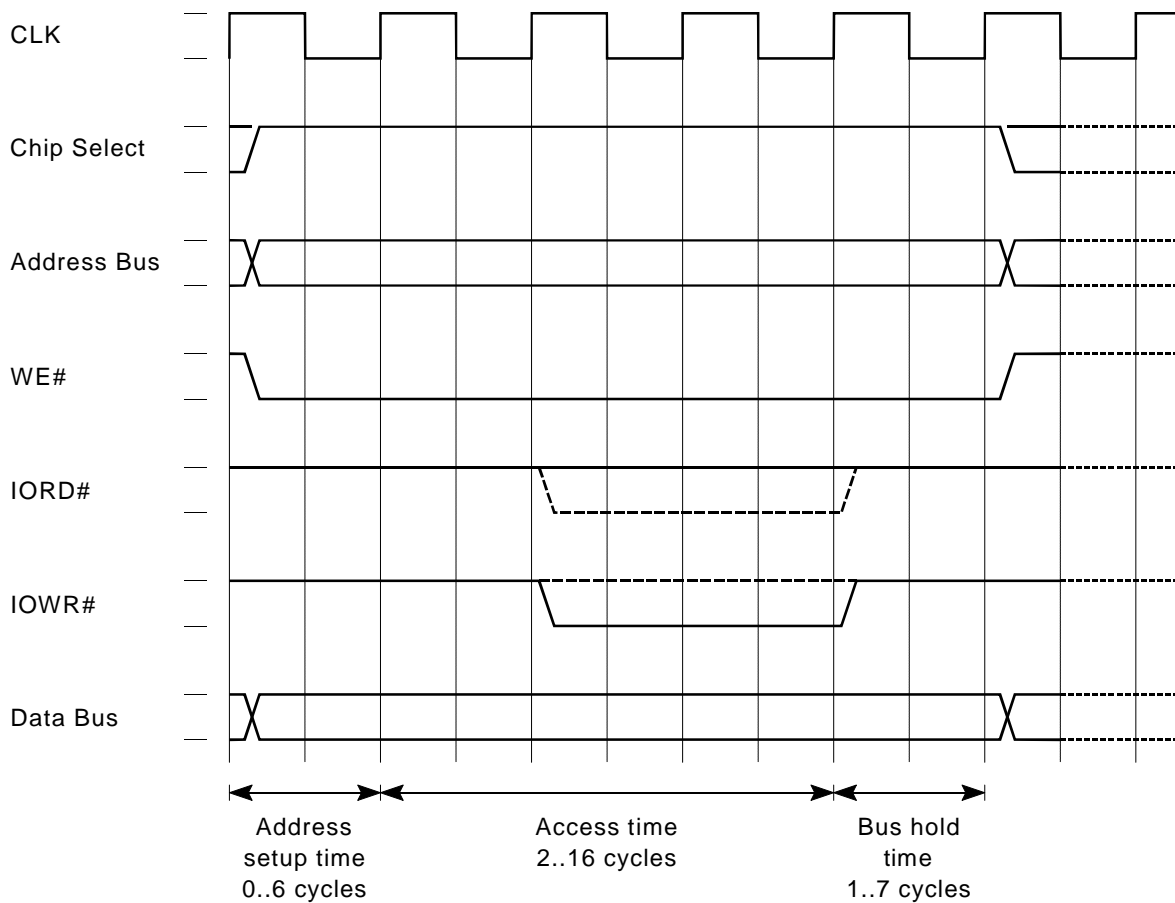

Figure 6.8: I/O Write Access

Note: If IORD# is used as I/O data strobe, IORD# instead of IOWR# is activated low.

6.2 I/O Bus Control

With I/O addresses, address setup, access and bus hold time can be specified by bits in the I/O address as follows:

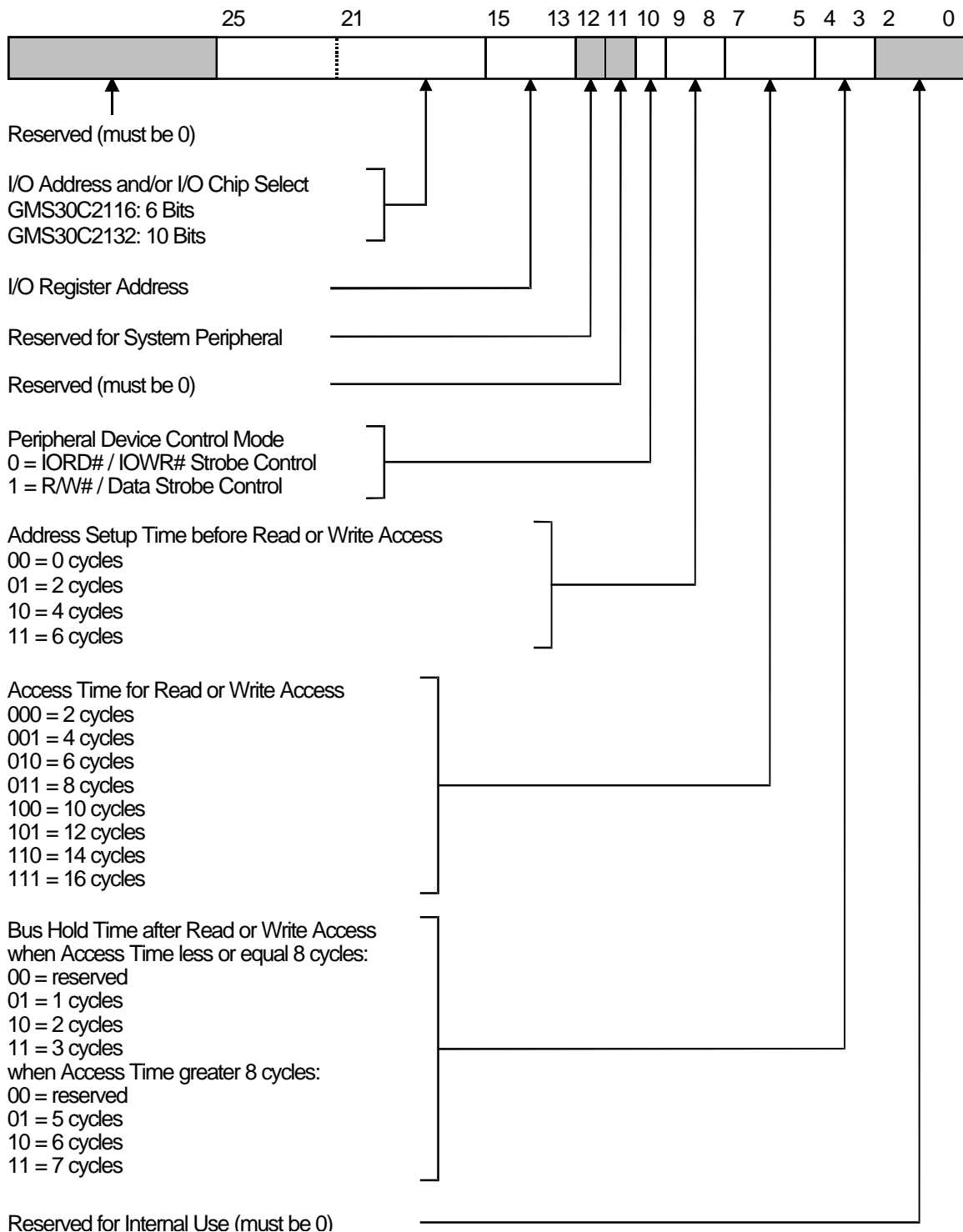

Figure 6.9: I/O Bus Control

Reserved bits must always be supplied as zero when specifying an I/O address in a program.

6.3 Bus Control Register BCR

Global register G20 is the write-only bus control register BCR. The BCR defines the parameters (bus timing, refresh control, page fault and parity error disable) for accessing external memory located in address spaces MEM0..MEM3.

All bits of the BCR are set to one on Reset. They are intended to be initialized according to the hardware environment.

The parity checks can be enabled or disabled separately for each of the four address spaces MEM0..MEM3.

Bits	Name	Description
31	Mem3ParityDisable	Parity check disable for address space MEM3 1 = disabled 0 = enabled
30	Mem2ParityDisable	Parity check disable for address space MEM2 1 = disabled 0 = enabled
29	Mem1ParityDisable	Parity check disable for address space MEM1 1 = disabled 0 = enabled
28	Mem0ParityDisable	Parity check disable for address space MEM0 1 = disabled 0 = enabled
27..24	Mem3Access	Access time for address space MEM3 1111 = 16 clock cycles 1110 = 15 clock cycles 1101 = 14 clock cycles 1100 = 13 clock cycles 1011 = 12 clock cycles 1010 = 11 clock cycles 1001 = 10 clock cycles 1000 = 9 clock cycles 0111 = 8 clock cycles 0110 = 7 clock cycles 0101 = 6 clock cycles 0100 = 5 clock cycles 0011 = 4 clock cycles 0010 = 3 clock cycles 0001 = 2 clock cycles 0000 = 1 clock cycle
23	Mem3Hold(2)	Bus hold time code for address space MEM3 (see table 6.3)

6.3 Bus Control Register BCR (continued)

Bits	Name	Description
22..20	Mem2Access	Access time for address space MEM2 111 = 8 clock cycles 110 = 7 clock cycles 101 = 6 clock cycles 100 = 5 clock cycles 011 = 4 clock cycles 010 = 3 clock cycles 001 = 2 clock cycles 000 = 1 clock cycle
19..18	Mem1Access	Access time for address space MEM1 11 = 4 clock cycles 10 = 3 clock cycles 01 = 2 clock cycles 00 = 1 clock cycle
17..16	Mem0Access	Access time for address space MEM0 11 = 4 clock cycles (CASx# low in cycles 3 and 4) 10 = 3 clock cycles (CASx# low in cycles 2 and 3) 01 = 2 clock cycles (CASx# low in cycle 2) 00 = 1 clock cycle (CASx# low in second half of cycle)
15	Mem1Hold	Bus hold time for address space MEM1 1 = 1 clock cycle 0 = 0 clock cycles
14	Mem2Setup	Address setup time for address space MEM2 1 = 1 clock cycle 0 = 0 clock cycles
13..12	RefreshSelect	Refresh rate select (CAS before RAS refresh) 00 = Refresh every 512 clock cycles 01 = Refresh every 256 clock cycles 10 = Refresh every 128 clock cycles 11 = Refresh disabled
11..10	RasPrecharge	RAS precharge time for address space MEM0 (when MEM0 is a DRAM type) 11 = 4 clock cycles 10 = 3 clock cycles 01 = 2 clock cycles 00 = 1 clock cycle Bus hold time for address space MEM0 (when MEM0 is not a DRAM type) 11 = 3 clock cycles 10 = 2 clock cycles 01 = 1 clock cycle 00 = 0 clock cycles
9..8	RasToCas	RAS to CAS delay time 11 = 4 clock cycles 10 = 3 clock cycles 01 = 2 clock cycles 00 = 1 clock cycle
7		reserved, must be 1

6.3 Bus Control Register BCR (continued)

Bits	Name	Description
6..4	PageSizeCode	Page size code (see table 6.4)
3..2	Mem3Hold(1..0)	Bus hold time code for address space MEM3 (see table 6.3)
1..0	Mem2Hold	Bus hold time for address space MEM2 11 = 3 clock cycles 10 = 2 clock cycles 01 = 1 clock cycle 00 = 0 clock cycles

Table 6.2: Bus Control Register BCR

The bus hold time for address space MEM3 is specified by bits 23 and 3..2 in the BCR as follows:

BCR(23)	BCR(3..2)	Bus Hold Time
1	11	7 clock cycles
1	10	6 clock cycles
1	01	5 clock cycles
1	00	4 clock cycles
0	11	3 clock cycles
0	10	2 clock cycles
0	01	1 clock cycle
0	00	0 clock cycles

Table 6.3: Bus Hold Time for MEM3

The DRAM type used and the physical page size of the DRAM are specified by bits 6..4 in the BCR. Table 6.4 shows the encoding of BCR(6..4) and the associated column address ranges for memory areas with bus sizes of 32, 16 and 8 bits.

BCR(6..4)	Column Address Range		
	32-bit Bus Size	16-bit Bus Size	8-bit Bus Size
000	A15..A2	A15..A1	A15..A0
001	A14..A2	A14..A1	A14..A0
010	A13..A2	A13..A1	A13..A0
011	A12..A2	A12..A1	A12..A0
100	A11..A2	A11..A1	A11..A0
101	A10..A2	A10..A1	A10..A0
110	A9..A2	A9..A1	A9..A0
111	A8..A2	A8..A1	A8..A0

6.4 Memory Control Register MCR

Global register G27 is the write-only memory control register MCR. The MCR controls additional parameters for the external memory, the internal memory refresh rate, the mapping of the entry table and the processor power management. All bits of the MCR are set to one on Reset. They must be initialized according to the hardware environment and the desired function. The reserved bits must not be changed when the MCR is updated.

Bits	Name	Description
31..26		reserved
25	OutputVoltage	1 = Rail-to-Rail 0 = Reduced
24	InputThreshold	1 = Input threshold according to VDD=5.0V 0 = Input threshold according to VDD=3.3V
23		reserved
22	PowerDown	1 = Processor is active 0 = Processor is in power-down mode
21	MEM0MemoryType	1 = Non-DRAM 0 = DRAM
20	IRAMRefreshTest	1 = Normal Mode 0 = Test Mode
19		reserved
18..16	IRAMRefreshRate	111 = Disabled 110 = Refresh every 2 clock cycles 101 = Refresh every 4 clock cycles 100 = Refresh every 8 clock cycles 011 = Refresh every 16 clock cycles 010 = Refresh every 32 clock cycles 001 = Refresh every 64 clock cycles (recommended refresh rate) 000 = Refresh every 128 clock cycles
15		reserved
14..12	EntryTableMap	111 = MEM3 110 = reserved 101 = reserved 100 = reserved 011 = Internal RAM (IRAM) 010 = MEM2 001 = MEM1 000 = MEM0
11	MEM3BusHoldBreak	1 = Break Disabled 0 = Break Enabled
10	MEM2BusHoldBreak	1 = Break Disabled 0 = Break Enabled
9	MEM1BusHoldBreak	1 = Break Disabled 0 = Break Enabled
8	MEM0BusHoldBreak	1 = Break Disabled 0 = Break Enabled

6.4 Memory Control Register MCR (continued)

Bits	Name	Description
7..6	MEM3BusSize	11 = 8 bit 10 = 16 bit 01 = reserved 00 = 32 bit
5..4	MEM2BusSize	11 = 8 bit 10 = 16 bit 01 = reserved 00 = 32 bit
3..2	MEM1BusSize	11 = 8 bit 10 = 16 bit 01 = reserved 00 = 32 bit
1..0	MEM0BusSize	11 = 8 bit 10 = 16 bit 01 = reserved 00 = 32 bit

Table 6.4: Memory Control Register MCR

6.4.1 Output Voltage

Bit 25 of the MCR controls the voltage of the output signals. The default setting is rail-to-rail. At a supply voltage of 5V, MCR(25) must be cleared to reduce the high-output signal in order to save on switching power consumption.

6.4.2 Input Threshold

Bit 24 of the MCR controls the input threshold voltage. The default setting is for a supply voltage of 5V. MCR(24) must be cleared for a supply voltage of 3.3V.

6.4.3 Power Down

Bit 22 of the MCR controls the power-down mode. The default setting is processor active. To switch the processor to power-down mode MCR(22) must be cleared. The switch to power-down is initiated by a transition from MCR(22) = 1 to MCR(22) = 0; thus, MCR(22) must be restored to one for at least one cycle before a new switch to power-down mode can occur.

In power-down mode, only the logic for the timer, IO3Control modes, interrupt and refresh is being clocked, all other clocks are disabled. The switch to power-down mode is delayed until the memory pipeline is empty. The processor is activated temporarily for refresh and bus arbitration cycles and is switched back to processor active by any interrupt or on Reset. Note that MCR(22) is not switched back to one by an interrupt.

6.4.4 IRAM Refresh Test

Bit 20 of the MCR specifies the internal RAM (IRAM) refresh test. The default setting is normal mode, $MCR(20) = 0$ specifies refresh test mode.

6.4.5 IRAM Refresh Rate

Bits 18..16 of the MCR specify the IRAM refresh rate in number (2..128) of processor cycles. The default setting is disabled.

6.4.6 Entry Table Map

Bits 14..12 of the MCR map the entry table (see section [2.4. Entry Table](#)) to one of the memory areas MEM0..MEM3 or to the IRAM. With a mapping to MEM3 (default setting), the entry table is mapped to the end of MEM3, with all other settings, the entry table is mapped to the beginning of the specified memory area.

6.4.7 MEMx Bus Hold Break

Bits 11..8 specify a memory bus hold break for MEM3..MEM0 respectively. The default setting is disabled. With enabled, bus hold cycles are skipped when the next memory access addresses the same memory area. Regularly, the bus hold break should be enabled; it must only be left disabled to accommodate (rare) SRAMs or ROMs which need all specified cycles before a new access can be started (e.g. for charge restore).

6.5 Input Status Register ISR

Global register G25 is the read-only input status register ISR. The ISR reflects the input levels at the pins IO1..IO3 as well as the input levels at the four interrupt pins INT1..INT4 and contains the EventFlag and the EqualFlag. In the present version reserved bits are read as zeros.

The input levels are not affected by the polarity bits in the FCR register, they reflect always the true signal level at the corresponding pins with a latency of 2..3 cycles, a 1 signals high level.

Bits	Name	Description
31..9		reserved
8	EventFlag	Set to 1 in IO3Timing Mode when IO3Level is equal to IO3Polarity Cleared to 0 by FCR(13) = 1 or write to the WCR
7	EqualFlag	Set to 1 in IO3Timing or IO3TimerInterrupt Mode when WCR(15..0) = TR(15..0) Cleared to 0 by FCR(13) = 1 or write to the WCR
6	IO3Level	Reflects the signal level at the IO3 Pin 1 = High Level 0 = Low Level
5	IO2Level	Reflects the signal level at the IO2 Pin 1 = High Level 0 = Low Level
4	IO1Level	Reflects the signal level at the IO1 Pin 1 = High Level 0 = Low Level
3	Int4Level	Reflects the signal level of interrupt input INT4 1 = High Level 0 = Low Level
2	Int3Level	Reflects the signal level of interrupt input INT3 1 = High Level 0 = Low Level
1	Int2Level	Reflects the signal level of interrupt input INT2 1 = High Level 0 = Low Level
0	Int1Level	Reflects the signal level of interrupt input INT1 1 = High Level 0 = Low Level

Table 6.5: Input Status Register ISR

6.6 Function Control Register FCR

Global register G26 is the write-only function control register FCR. The FCR controls the polarity and function of the I/O pins IO1..IO3 and the interrupt pins INT1..INT4, the timer interrupt mask and priority, the bus lock and the Extended Overflow exception. All bits of the FCR are set to one on Reset. They must be initialized according to the hardware environment and the desired function. The reserved bits must not be changed when the FCR is updated.

Each of the four interrupt pins INT1..INT4 can cause a processor interrupt when the corresponding interrupt mask bit is cleared. The corresponding polarity bit determines whether the signal at the interrupt pin must be low (polarity bit = 0) or high (polarity bit = 1) to cause an interrupt. Additionally, the internal timer interrupt can be enabled or disabled separately.

Each of the I/O pins IO1..IO3 can be either used as input or interrupt signal (IOxDirection = 1) or as output (IOxDirection = 0). See section 6.9.3 [Bus Signal Description](#) for details.

Bits	Name	Description
31	INT4Mask	1 = Interrupt INT4 Disabled 0 = Interrupt INT4 Enabled
30	INT3Mask	1 = Interrupt INT3 Disabled 0 = Interrupt INT3 Enabled
29	INT2Mask	1 = Interrupt INT2 Disabled 0 = Interrupt INT2 Enabled
28	INT1Mask	1 = Interrupt INT1 Disabled 0 = Interrupt INT1 Enabled
27	INT4Polarity	1 = Non-Inverted (Interrupt on High Level) 0 = Inverted (Interrupt on Low Level)
26	INT3Polarity	1 = Non-Inverted (Interrupt on High Level) 0 = Inverted (Interrupt on Low Level)
25	INT2Polarity	1 = Non-Inverted (Interrupt on High Level) 0 = Inverted (Interrupt on Low Level)
24	INT1Polarity	1 = Non-Inverted (Interrupt on High Level) 0 = Inverted (Interrupt on Low Level)
23	TINTDisable	1 = Timer Interrupt Disabled 0 = Timer Interrupt Enabled
22		reserved
21..20	TimerPriority	11 = Priority 6 (higher than Priority of INT1) 10 = Priority 8 (higher than Priority of INT2) 01 = Priority 10 (higher than Priority of INT3) 00 = Priority 12 (higher than Priority of INT4)
19..18		reserved
17	BusLock	DMA Access (see also section 6.9.3. ACT signal): 1 = Non-Locked 0 = Locked out
16	EOVDisable	Extended Overflow Exception: 1 = Disabled 0 = Enabled

6.6 Function Control Register FCR (continued)

Bits	Name	Description
15..14		reserved
13..12	IO3Control	IO3 Control State: 11 = IO3Standard Mode 10 = Watchdog Mode 01 = IO3Timing Mode 00 = IO3TimerInterrupt Mode
11		reserved
10	IO3Direction	1 = Input 0 = Output
9	IO3Polarity	1 = Non-Inverted 0 = Inverted
8	IO3Mask	On Input: 1 = IO3 Interrupt Disabled 0 = IO3 Interrupt Enabled On Output: 1 = IO3 Output reflects IO3Polarity 0 = Reserved
7		reserved
6	IO2Direction	1 = Input 0 = Output
5	IO2Polarity	1 = Non-Inverted 0 = Inverted
4	IO2Mask	On Input: 1 = IO2 Interrupt Disabled 0 = IO2 Interrupt Enabled On Output: 1 = IO2 Output reflects IO2Polarity 0 = Reserved
3		reserved
2	IO1Direction	1 = Input 0 = Output
1	IO1Polarity	1 = Non-Inverted 0 = Inverted
0	IO1Mask	On Input: 1 = IO1 Interrupt Disabled 0 = IO1 Interrupt Enabled On Output: 1 = IO1 Output reflects IO1Polarity 0 = Output reflects Supervisor Flag XOR NOT IO1Polarity

Table 6.6: Function Control Register FCR

6.7 Watchdog Compare Register WCR

Global register G24 is the watchdog compare register WCR. Only bits 15..0 are used, bits 31..16 are reserved, they must be zero on a move to the WCR. In the present version, bits 31..16 are read as zero. The WCR is used by the IO3 control modes (see section 6.8. IO3 Control Modes).

6.8 IO3 Control Modes

Additionally to the standard use like IO1 and IO2 (see section 6.9.3. Bus Signal Description), there are special control modes in combination with the IO3 pin. These control modes are specified by FCR(13) and FCR(12).

On all IO3 control modes, the watchdog compare register WCR must be set before the control mode is specified in the FCR, otherwise the EqualFlag could be set erroneously.

The EqualFlag and the EventFlag are being cleared on all IO3 control modes by either setting FCR(13) to one or a move to the watchdog compare register WCR.

6.8.1 IO3Standard Mode

FCR(13) = 1, FCR(12) = 1 specifies IO3Standard mode.

Standard use of IO3 without any additional IO3 control functions. See section 6.9.3. signals IO1..IO3.

6.8.2 Watchdog Mode

FCR(13) = 1, FCR(12) = 0 specifies Watchdog mode.

A Reset exception occurs when $WCR(15..0) = TR(15..0)$. The standard use of IO3 is not affected.

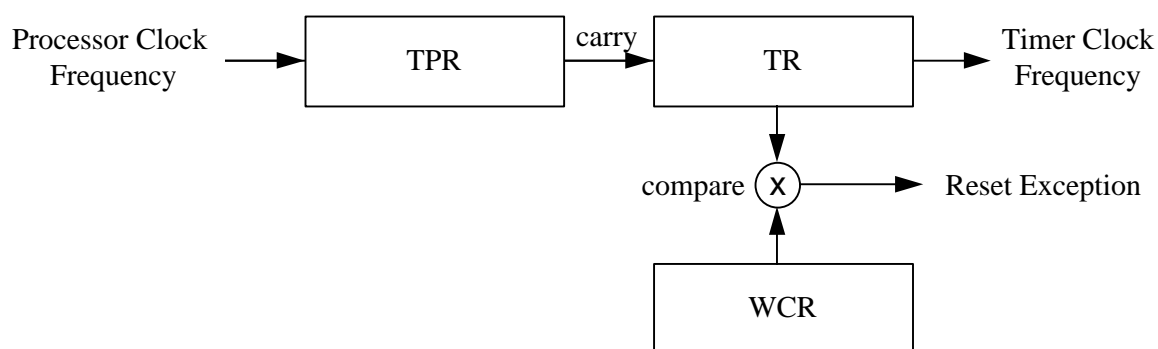

Note: The WCR must be set before the IO3 control mode is determined by FCR(13..12) as Watchdog mode.

6.8.3 IO3Timing Mode

FCR(13) = 0, FCR(12) = 1 specifies the IO3Timing mode.

On IO3Direction = Input:

When input signal IO3Level = IO3Polarity, the EventFlag ISR(8) is set and the current contents of the TR(15..0) is copied to the WCR. Thus, the time of the event indicated by the 16 low-order bits of the TR is captured in the WCR. When WCR(15..0) = TR(15..0) before the EventFlag is set, the EqualFlag ISR(7) is set. Either flag set causes an interrupt when the IO3 interrupt is enabled.

Note: The EventFlag and the EqualFlag can be used to distinguish between an input signal transition and a timeout. The EventFlag can be set even after the EqualFlag (but not vice versa) during the interrupt latency time; thus, when the EventFlag is set, WCR(15..0) contains always the time when the input reached the level specified by IO3Polarity. Note that the EventFlag is immediately set on entering IO3Timing mode when the input signal is already on the specified level. WCR(15..0) must be set on a value different from the value of the TR(15..0), otherwise the EqualFlag is set immediately. The maximum span for the timeout is $2^{16}-1$ ticks of the TR.

IO3Direction = Output:

When WCR(15..0) = TR(15..0), the EqualFlag is set and an interrupt occurs when the IO3 interrupt is enabled. Additionally, an internal toggle latch is toggled. The IO3 output signal is high when the value of the toggle latch and IO3Polarity are not equal, otherwise low. Thus, each toggling causes a transition of the IO3 output signal. The toggle latch is cleared by setting FCR(13) to 1.

Note: This mode can be used to create an arbitrary output signal sequence by just updating the WCR. When the program switches to IO3Standard mode after the end of a signal sequence and the toggle latch remained set to 1, FCR(13) must be set to 1 and IO3Polarity be inverted coincidentally in the same move to FCR to avoid a transition of the IO3 output signal. The IO3 interrupt must also be disabled in the same move to FCR to avoid an interrupt from the output signal.

6.8.4 IO3TimerInterrupt Mode

FCR(13) = 0, FCR(12) = 0 specifies the IO3TimerInterrupt mode.

Additionally to the standard use of IO3, the condition WCR(15..0) = TR(15..0) sets the EqualFlag ISR(7) and causes an IO3 interrupt regardless of the IO3Mask in FCR(8) (IO3 interrupt disable).

Note: When the IO3 interrupt is disabled, the IO3TimerInterrupt mode can be used independently of the use of IO3 as input or output. When the IO3 interrupt is enabled, the IO3TimerInterrupt mode can be used as a timeout for the IO3 interrupt. The EqualFlag can then be used to distinguish between timeout and an IO3 interrupt.

6.9 Bus Signals

6.9.1 Bus Signals for the GMS30C2132 Processor

The following table is an overview of the bus signals of the GMS30C2132 microprocessor. For a detailed description of the function of the bus signals refer to section [6.9.3. Bus Signal Description](#).

The signal states are defined as I = input, O = output and Z = three-state (inactive).

States	Pin count	Signal Name	Description
I	1	XTAL1/CLKIN	External Crystal, optionally Clock Input
O	1	XTAL2	External Crystal
O	1	CLKOUT	Clock Output
O/Z	26	A25..A0	Address Bus
O/I	32	D31..D0	Data Bus
O/I	4	DP0..DP3	Parity bits
O/Z	1	RAS#	DRAM RAS signal / Chip Select for MEM0
O/Z	4	CAS0#..CAS3#	DRAM CAS signal for bytes 0..3
O/Z	1	WE#	Write Enable for DRAM and R/W# for I/O
O/Z	3	CS1#..CS3#	Chip Select for MEM1..MEM3
O/Z	4	WE0#..WE3#	Write Enable for SRAM bytes 0..3
O/Z	1	OE#	Output Enable for SRAMs and EPROMs
O/Z	1	IORD#	I/O Read Strobe, optionally I/O Data Strobe
O/Z	1	IOWR#	I/O Write Strobe
O	1	RQST	Bus Request Output
I	1	GRANT#	Bus Grant Input
O	1	ACT	Active as Bus Master
I	4	INT1..INT4	Interrupt Inputs
O/I	3	IO1..IO3	Programmable Input / Output
I	1	RESET#	Reset Input
	16	NC	No Connect (not for GMS30C2132-144TQFP)
	26	VDD	Power Supply Voltage
	26	GND	Ground

Total: 160 (144 for GMS30C2132-144TQFP)

Table 6.7: Bus Signals for the GMS30C2132 Processor

6.9.2 Bus Signals for the GMS30C2116 Processor

The following table is an overview to the bus signals of the GMS30C2116 microprocessor. For detailed description of the function of the bus signals refer to section [6.9.3. Bus Signal Description](#).

The signal states are defined as I = input, O = output and Z = three-state (inactive).

States	Pin count	Signal-Names	Description
I	1	XTAL1/CLKIN	External Crystal, optionally Clock Input
O	1	XTAL2	External Crystal
O	1	CLKOUT	Clock Output
O/Z	22	A21..A0	Address Bus
O/I	16	D15..D0	Data Bus
O/I	2	DP0..DP1	Parity bits
O/Z	1	RAS#	DRAM RAS signal / Chip Select for MEM0
O/Z	2	CAS0#..CAS1#	DRAM CAS signal for bytes 0..1 / 2..3
O/Z	1	WE#	Write Enable for DRAM and R/W# for I/O
O/Z	3	CS1#..CS3#	Chip Select for MEM1..MEM3
O/Z	2	WE0#..WE1#	Write Enable for SRAM bytes 0..1 / 2..3
O/Z	1	OE#	Output Enable for SRAMs and EPROMs
O/Z	1	IORD#	I/O Read Strobe, optionally I/O Data Strobe
O/Z	1	IOWR#	I/O Write Strobe
O	1	RQST	Bus Request Output
I	1	GRANT#	Bus Grant Input
O	1	ACT	Active as Bus Master
I	4	INT1..INT4	Interrupt Inputs
O/I	3	IO1..IO3	Programmable Input / Output
I	1	RESET#	Reset Input
	16	VDD	Power Supply Voltage
	18	GND	Ground

Total: 100

Table 6.8: Bus Signals for the GMS30C2116 Processor

6.9.3 Bus Signal Description

The following section describes the bus signals for both the GMS30C2132 and GMS30C2116 microprocessor in detail.

In the following signal description, the signal states are defined as I = input, O = output and Z = three-state (inactive).

States	Names	Use
I	XTAL1/CLKIN	Input for quartz crystal. When the clock is generated by an external clock generator, XTAL1 is used as clock input. The clock signal is used undivided.
O	XTAL2	Output for quartz crystal. XTAL2 is not connected when an external clock generator is used.
O	CLKOUT	Clock signal output. CLKOUT has the same cycle time as the internal clock. It can be used to supply a clock signal to peripheral devices.
I	RESET#	Reset processor. RESET# low resets the processor to the initial state and halts all activity. RESET# must be low for at least two cycles. On a transition from low to high, a Reset exception occurs and the processor starts execution at the Reset entry (see section 2.4. Entry Tables, Table 2.6.). The transition may occur asynchronously to the clock.
O/Z	A25..A0	The address bits A25..A0 represent the address bus. An active high bit signals a "one". A0 is the least significant bit. With the E1-16, only A22..A0 are connected to the address bus pins.
O/I	D31..D0	Data bus. The signals D31..D0 (D15..D0 with the GMS30C2116) represent the bi-directional data bus; active high signals a "one". At a read access, data is transferred from the data bus to the register set or to the instruction cache only at the cycle corresponding to the last actual read access cycle, thus inhibiting garbled data from being transferred. At a write access, the data bus signals are activated during the address setup, write and bus hold cycle(s). A halfword or byte to be written is multiplexed from its right-adjusted position in a register to the addressed halfword or byte position. Thus, no external multiplexing of data signals is required. On a 32-bit wide memory area, byte addresses 0, 1, 2 and 3 correspond to D31..D24, D23..D16, D15..D8 and D7..D0 respectively (big endian). On a 16-bit wide memory area, byte address 2 and 3 in the first access and byte addresses 0 and 1 in the second access correspond to D15..D8 and D7..D0 respectively. On a 8-bit wide memory area, byte addresses 3..0 correspond to D7..D0 in succeeding accesses.

6.9.3 Bus Signal Description (continued)

States	Names	Use
O/I	DP0..DP3	<p>Data Parity signals. DP0..DP3 represent the bi-directional parity signals; active high indicates a "one". With the GMS30C2132, DP0, DP1, DP2 and DP3 correspond to D31..D24, D23..D16, D15..D8 and D7..D0 respectively. With the GMS30C2116, DP0 and DP1 correspond to D15..D8 and D7..D0 respectively.</p> <p>At a write access, all data parity signals are activated during the address setup, write and bus hold cycles.</p> <p>At a read access, the corresponding data parity signals are evaluated at the last read access cycle when parity checking for the addressed memory area is enabled.</p> <p>Parity "odd" is used, that is, the correct parity bit is "one" when all bits of the corresponding byte are "zero".</p>
O/Z	RAS#	<p>Row Address Strobe. Active low indicates row address strobe asserted.</p> <p>RAS# is activated high and then again low when the processor accesses a new page in the DRAM address space, that is when any of the (high order) RAS address bits is different from the RAS address bits of the last DRAM access. RAS# is left low after any own DRAM access.</p> <p>RAS# is activated high, low and then high by a refresh cycle.</p> <p>When the bus is granted to another bus master, the processor starts the next DRAM access as a RAS access.</p> <p>At any non-RAS address cycle, RAS# is left unchanged, thus, a previously selected DRAM page is not affected.</p> <p>When a SRAM is placed in memory area MEM0, RAS# is used as the chip select signal for this SRAM.</p>
O/Z	CAS0#..CAS3#	<p>Column Address Strobe. Active low indicates column address strobe asserted. CAS0#..CAS3# are only used by a DRAM for column access cycles and for "CAS before RAS" refresh.</p> <p>With the GMS30C2132, CAS0#..CAS3# correspond to the column address enable signals for D31..D24, D23..D16, D15..D8 and D7..D0 respectively.</p> <p>With the GMS30C2116, CAS0# and CAS1# correspond to the column address enable signals for D15..D8 and D7..D0 respectively.</p>
O/Z	WE#	<p>Write Enable. WE# is signaled in the same cycle(s) as address signals. Active low indicates a write access, active high indicates a read access.</p> <p>WE# is intended to be used as DRAM Write Enable and as R/W# for I/O access when IORD# is specified as data strobe (see IORD#).</p> <p>Note: WE# can also be used to control bus transceivers when peripheral devices or slow memories must be separated from the processor data bus in order to decrease the capacitive load of the processor data bus.</p>

6.9.3 Bus Signal Description (continued)

States	Names	Use
O/Z	CS1#..CS3#	<p>Chip Select. Chip select is signaled in the same cycle(s) as the address signals. Active low of CS1#..CS3# indicates chip select for the memory areas MEM1..MEM3 respectively.</p> <p>Note: RAS# is used as chip select for a non-DRAM memory in MEM0.</p>
O/Z	WE0#..WE3#	<p>SRAM Write Enable. Active low indicates write enable for the corresponding byte, active high indicates write disable.</p> <p>With the GMS30C2132, WE0#..WE3# correspond to the write enable signals for D31..D24, D23..D16, D15..D8 and D7..D0 respectively.</p> <p>With the GMS30C2116, WE0# and WE1# correspond to the write enable signals for D15..D8 and D7..D0 respectively.</p>
O/Z	OE#	<p>Output Enable for SRAMs and EPROMs. OE# is active low on a SRAM or EPROM read access.</p>
O/Z	IORD#	<p>I/O Read Strobe, optionally I/O data strobe. The use of IORD# is specified in the I/O address. Bit 10 = 0 specifies I/O read strobe, bit 10 = 1 specifies I/O data strobe. When specified as I/O read strobe, IORD# is low on I/O read access cycles, high on all other cycles. When specified as I/O data strobe, IORD# is low on any I/O access cycles, high on all other cycles.</p> <p>Note: When IORD# is specified as I/O data strobe, WE# can be used as R/W# signal.</p>
O/Z	IOWR#	<p>I/O Write Strobe. When specified as I/O write strobe by I/O address bit 10 = 0, IOWR# is active low on I/O write access cycles.</p>
O	RQST	<p>RQST signals the request for a memory or I/O access. RQST is high from the beginning of the request until the requested access is completed.</p>
I	GRANT#	<p>Bus Grant. GRANT# is signaled low by an (off-chip) bus arbiter to grant access to the bus for memory and I/O cycles. When Grant# is switched from low to high during an access, the bus is only released to another bus master after completion of the current access. The GRANT# signal supplied by a bus arbiter may be asynchronous to the clock; it is synchronized on-chip to avoid metastability. For systems with a single bus master, GRANT# must be tied low.</p> <p>Note: GRANT# is recommended to be kept low by the bus arbiter on the bus master with the last access; thus, any subsequent access by the same bus master saves the synchronization time.</p>

6.9.3 Bus Signal Description (continued)

States	Names	Use
O	ACT	<p>Active as bus master. ACT is signaled high when GRANT# is low and it is kept high during a current bus access. Since GRANT# is asynchronous, ACT follows GRANT# with a delay of 2..3 cycles. ACT is also kept high on a bus lock (FCR(17) = 0) from the beginning of the first access after FCR(17) is cleared to zero until the bus lock is released by setting FCR(17) to one.</p> <p>Note: When ACT transits from high to low, the address and data bus are switched to threats (inactive). All bus control signals marked O/Z are driven high and then switched to threats. These signals are kept high by an on-chip resistor (ca. 1 MΩ) tied on-chip to Vcc.</p>
I	INT1..INT4	<p>Interrupt Request. A signal of a specified level on any of the INT1..INT4 interrupt request pins causes an interrupt exception when the interrupt lock flag L is zero and the corresponding INTxMask bit in FCR is not set. The INTxPolarity bits in FCR specify the level of the INTx signals: INTxPolarity = 1 causes an interrupt on a high input signal level, INTxPolarity = 0 causes an interrupt on a low input signal level. INT1..INT4 may be signaled asynchronously to the clock; they are not stored internally.</p> <p>A transition of INT1..INT4 is effective after a minimum of three cycles. The response time may be much higher depending on the number of cycles to the end of the current instruction or the number of cycles until the interrupt lock flag L is cleared.</p> <p>Note: The signal level of INT1..INT4 can be inspected in ISR(0)..ISR(4). Thus, with the corresponding INTxMask bit set, INT1..INT4 can be used just as input signals.</p>
O/I	IO1..IO3	<p>General Input-Output. IO1..IO3 can be individually configured via IOxDirection bits in the FCR as either input or output pins. When configured as input, IO1..IO3 can be used like INT1..INT4 for additional interrupt or input signals. When configured as output, the IOxPolarity bit in FCR specifies the output signal level. IOxPolarity = 1 specifies a high level, IOxPolarity = 0 specifies a low level. An output signal at IO1 or IO2 cannot cause an interrupt regardless of the corresponding IOxMask bit; however, it can be inspected as IOxLevel in ISR (e.g. for testing).</p> <p>The supervisor flag S can be switched to the IO1 pin by configuring IO1 as an output and clearing the IO1 mask. IO1Polarity = 1 switches S non-inverted to IO1 (high when S = 1), IO1Polarity = 0 switches S inverted to IO1.</p> <p>IO3 can be used for various control functions, see section 6.8. IO3 Control Modes.</p>

6.10 DC Characteristics

Absolute Maximum Ratings

Case temperature T_C under Bias: 0°C to $+85^{\circ}\text{C}$

extended temperature range on request

Storage Temperature: -65°C to $+150^{\circ}\text{C}$

Voltage on any Pin with respect to ground: -0.5V to $V_{CC} + 0.5\text{V}$

D.C. Parameters

Supply Voltage V_{CC} : $5\text{V} \pm 0.25\text{V}$ or $3.3\text{V} \pm 0.30\text{V}$

Case Temperature T_{CASE} : 0°C to $+85^{\circ}\text{C}$

Symbol	Parameter		Min	Typ	Max	Unit	Notes
V_{IL}	Input LOW Voltage		-0.3		+0.8	V	except CLKIN
V_{IH1}	Input HIGH Voltage		2.0		$V_{CC}+0.3$	V	except CLKIN, RESET#
V_{IH2}			0.7 V_{CC}		$V_{CC}+0.3$	V	RESET#
V_{OL}	Output LOW Voltage				0.45	V	at 4mA
V_{OH}	Output HIGH Voltage		2.4			V	at 1mA
I_{CC1}	Power	$V_{CC} = 5\text{V}$ CLOCK=66§ 0		182		mA	
I_{CC2}	Supply	$V_{CC} = 5\text{V}$ CLOCK=40§ 0		110		mA	
I_{CC3}	Current	$V_{CC} = 3.3\text{V}$ CLOCK=40§ 0		60		mA	
I_{CC4}		$V_{CC} = 3.3\text{V}$ CLOCK=25§ 0		38		mA	
I_{PD1}	Power	$V_{CC} = 5\text{V}$ CLOCK=66§ 0		29		mA	
I_{PD2}	Down	$V_{CC} = 5\text{V}$ CLOCK=40§ 0		17.5		mA	
I_{PD3}		$V_{CC} = 3.3\text{V}$ CLOCK=40§ 0		11.5		mA	
I_{PD4}	Current	$V_{CC} = 3.3\text{V}$ CLOCK=25§ 0		10.0		mA	

6.10 DC Characteristics (continued)

Symbol	Parameter	Min	Typ	Max	Unit	Notes
I_{LI}	Input Leakage Current			± 20	μA	
I_{LO}	Output Leakage Current			± 20	μA	
C_{CLK}	Clock Capacitance			10	pF	
C_{ADR}	Output Capacitance A12..A0			15	pF	
$C_{I/O}$	Input/output Capacitance all other signals			10	pF	

Table 6.9: DC Characteristics

6.11 AC Characteristics

The formulas for the AC-characteristics are based on a load capacity of 30 pF on the concerned signals. To get the real timing values, the actual capacitive load must be taken into account. This is done by the addition or subtraction of load dependent delay times, labeled as Δt_N or Δt_P respectively (see [table 6.10. Load Dependent Delay Times](#)).

Note that only the difference between 30 pF and the actual capacity load must be used for the calculation of the Δt values. All signals except CLKIN are referenced to 1.4V. The AC-characteristics are based on $T_{CASE} = 0$ to 85°C , $V_{CC} = 5\text{V} \pm 0.25\text{V}$ (unless otherwise noted).

Δt_N	60 ps/pF
Δt_P	40 ps/pF

Table 6.10: Load Dependent Delay Times

Note: All signals (except the clock signal itself) are referenced to the corresponding driving signal, not to the clock input as is usual. This method eliminates the varying delay times between output signals relative to the clock input signal and allows more precise bus timing definitions, resulting in faster bus cycles.

6.11.1 Processor Clock

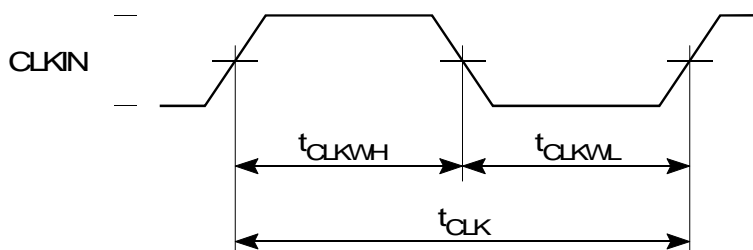

Figure 6.10: Processor Clock

V_{CC}	Symbol	Description	Min Time (ns)	Max Time (ns)
$5\text{V} \pm 0.25\text{V}$	t_{CLK}	CLK period	15	1000
	t_{CLKWH}	CLK high time	6	-
	t_{CLKWL}	CLK low time	6	-
$3.3\text{V} \pm 0.30\text{V}$	t_{CLK}	CLK period	25	1000
	t_{CLKWH}	CLK high time	10	-
	t_{CLKWL}	CLK low time	10	-

Table 6.11: Processor Clock Times

Note: CLKIN timing is referenced to $V_{CC}/2$.

6.11.2 DRAM RAS Access

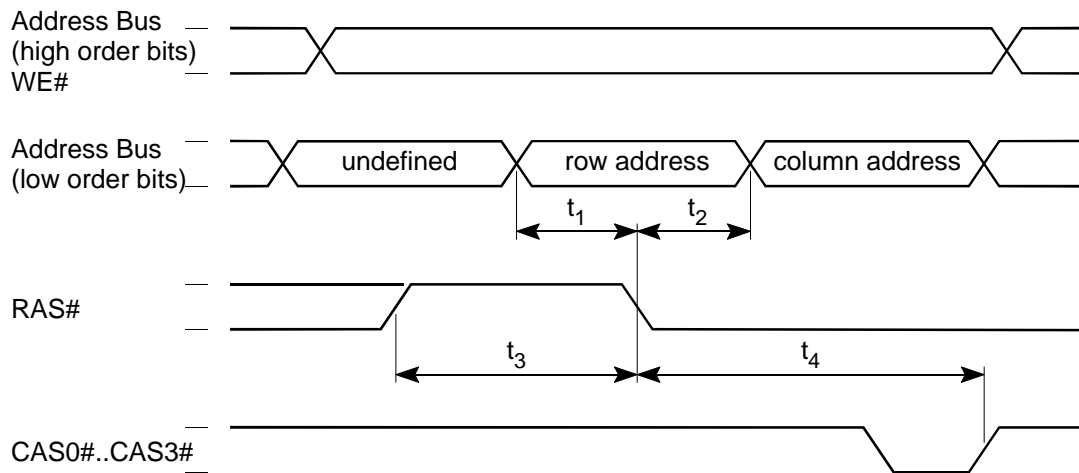

Figure 6.11: DRAM RAS Access

Symbol	Description	Formula
t_1	Row Address A12..A0 setup time to RAS# (min.)	$(\text{number of RAS precharge cycles} - 1) \times t_{\text{CLK}}$ $+ t_{\text{CLKWH}} + 0.5 \text{ ns} + \Delta t_{\text{N}} \text{ (a)} - \Delta t_{\text{P}} \text{ (b)}$ Note: (a) refers to capacitive load on signal RAS# (b) refers to capacitive load on signals A12..A0
t_2	Row Address A12..A0 hold time after RAS# (min.)	$(\text{number of RAS to CAS delay cycles} - 1) \times t_{\text{CLK}}$ $+ t_{\text{CLKWL}} - 1.1 \text{ ns} + \Delta t_{\text{P}} \text{ (a)} - \Delta t_{\text{N}} \text{ (b)}$ Note: (a) refers to capacitive load on signals A12..A0 (b) refers to capacitive load on signal RAS#
t_3	RAS# pulse width high (RAS# precharge) (min.)	$(\text{number of RAS precharge cycles}) \times t_{\text{CLK}}$
t_4	RAS# low before end of CAS0#..CAS3# (min.)	$(\text{number of RAS to CAS delay cycles}$ $+ \text{access cycles} - 1) \times t_{\text{CLK}}$ $+ t_{\text{CLKWL}} - 2.5 \text{ ns} + \Delta t_{\text{N}} \text{ (a)} - \Delta t_{\text{N}} \text{ (b)}$ Note: (a) refers to capacitive load on signals CAS0#..CAS3# (b) refers to capacitive load on signal RAS#

6.11.3 DRAM Fast Page Mode Access

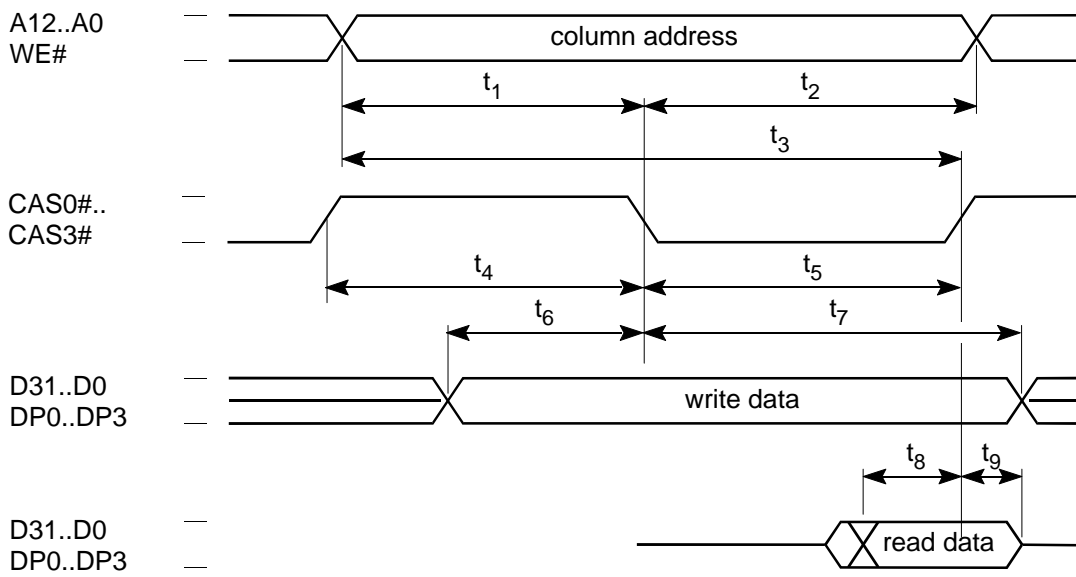

Figure 6.12: DRAM Fast Page Mode Access

6.11.3.1 Multi-Cycle Access

Symbol	Description	Formula
t_{1a}	Column address A12..A0 setup time to CAS0#..CAS3#	$(\text{number of CAS inactive cycles}) \times t_{CLK}$ $- 0.1 \text{ ns} + \Delta t_N (a) - \Delta t_P (b)$ Note: (a) refers to capacitive load on signals CAS0#..CAS3# (b) refers to capacitive load on signals A12..A0
t_{1b}	WE# setup time to CAS0#..CAS3#	$(\text{number of CAS inactive cycles}) \times t_{CLK}$ $- 1.1 \text{ ns} + \Delta t_N (a) - \Delta t_N (b)$ Note: (a) refers to capacitive load on signals CAS0#..CAS3# (b) refers to capacitive load on signal WE#
t_{2a}	Column address A12..A0 hold time after CAS0#..CAS3# low (min.)	$(\text{number of CAS active cycles}) \times t_{CLK}$ $- 0.5 \text{ ns} + \Delta t_P (a) - \Delta t_N (b)$ Note: (a) refers to capacitive load on signals A12..A0 (b) refers to capacitive load on signals CAS0#..CAS3#
t_{2b}	WE# hold time after CAS0#..CAS3# low (min.)	$(\text{number of CAS active cycles}) \times t_{CLK}$ $- 0.1 \text{ ns} + \Delta t_N (a) - \Delta t_N (b)$ Note: (a) refers to capacitive load on signal WE# (b) refers to capacitive load on signals CAS0#..CAS3#

6.11.3.1 Multi-Cycle Access (continued)

Symbol	Description	Formula
t_3	Column address A12..A0 valid before end of CAS0#..CAS3# (min.)	(number of access cycles) $\times t_{CLK}$ - 0.1 ns + Δt_N (a) - Δt_P (b) Note: (a) refers to capacitive load on signals CAS0#..CAS3# (b) refers to capacitive load on signals A12..A0
t_4	CAS0#..CAS3# pulse width high (CAS precharge) (min.)	(number of CAS inactive cycles) $\times t_{CLK}$ - 0.1 ns
t_5	CAS0#..CAS3# pulse width low (min.)	(number of CAS active cycles) $\times t_{CLK}$ - 1.4 ns
t_6	Write data D31..D0, DP0..DP3 setup time to CAS0#..CAS3# (min.)	(number of CAS inactive cycles) $\times t_{CLK}$ - 1.2 ns + Δt_N (a) - Δt_N (b) Note: (a) refers to capacitive load on signals CAS0#..CAS3# (b) refers to capacitive load on signals D31..D0, DP0..DP3
t_7	Write data D31..D0, DP0..DP3 hold time after CAS0#..CAS3# low (min.)	(number of CAS active cycles) $\times t_{CLK}$ - 0.1 ns + Δt_N (a) - Δt_N (b) Note: (a) refers to capacitive load on signals D31..D0, DP0..DP3 (b) refers to capacitive load on signals CAS0#..CAS3#
t_8	Read data D31..D0, DP0..DP3 setup time to end of CAS0#..CAS3# (min.)	0 ns
t_9	Read data D31..D0, DP0..DP3 hold time (min.)	0 ns Note: Read data is sampled by the skew-compensated CAS0#..CAS3# signals and latched internally

6.11.3.2 Single-Cycle Access

Symbol	Description	Formula
t_{1a}	Column address A12..A0 setup time to CAS0#..CAS3# (min.)	t_{CLKWH} - 1.0 ns + Δt_N (a) - Δt_P (b) Note: (a) refers to capacitive load on signals CAS0#..CAS3# (b) refers to capacitive load on signals A12..A0
t_{1b}	WE# setup time to CAS0#..CAS3# (min.)	t_{CLKWH} - 1.9 ns + Δt_N (a) - Δt_N (b) Note: (a) refers to capacitive load on signals CAS0#..CAS3# (b) refers to capacitive load on signal WE#

6.11.3.2 Single-Cycle Access (continued)

Symbol	Description	Formula
t_{2a}	Column address A12..A0 hold time after CAS0#..CAS3# low (min.)	$t_{CLKWL} + 0.1 \text{ ns} + \Delta t_P (a) - \Delta t_N (b)$ Note: (a) refers to capacitive load on signals A12..A0 (b) refers to capacitive load on signals CAS0#..CAS3#
t_{2b}	WE# hold time after CAS0#..CAS3# low (min.)	$t_{CLKWL} + 0.5 \text{ ns} + \Delta t_N (a) - \Delta t_N (b)$ Note: (a) refers to capacitive load on signal WE# (b) refers to capacitive load on signals CAS0#..CAS3#
t_3	Column address A12..A0 valid before end of CAS0#..CAS3# (min.)	$t_{CLK} - 0.1 \text{ ns} + \Delta t_N (a) - \Delta t_P (b)$ Note: (a) refers to capacitive load on signals CAS0#..CAS3# (b) refers to capacitive load on signals A12..A0
t_4	CAS0#..CAS3# pulse width high (CAS precharge) (min.)	$t_{CLKWH} - 0.9 \text{ ns}$
t_5	CAS0#..CAS3# pulse width low (min.)	$t_{CLKWL} - 0.9 \text{ ns}$
t_6	Write data D31..D0, DP0..DP3 setup time to CAS0#..CAS3# (min.)	$t_{CLKWH} - 2.1 \text{ ns} + \Delta t_N (a) - \Delta t_N (b)$ Note: (a) refers to capacitive load on signals CAS0#..CAS3# (b) refers to capacitive load on signals D31..D0, DP0..DP3
t_7	Write data D31..D0, DP0..DP3 hold time after CAS0#..CAS3# low (min.)	$t_{CLKWL} + 0.5 \text{ ns} + \Delta t_N (a) - \Delta t_N (b)$ Note: (a) refers to capacitive load on signals D31..D0, DP0..DP3 (b) refers to capacitive load on signals CAS0#..CAS3#
t_8	Read data D31..D0, DP0..DP3 setup time to end of CAS0#..CAS3# (min.)	0 ns
t_9	Read data D31..D0, DP0..DP3 hold time (min.)	0 ns Note: Read data is sampled by the skew-compensated CAS0#..CAS3# signals and latched internally

6.11.4 DRAM CAS-Before-RAS Refresh

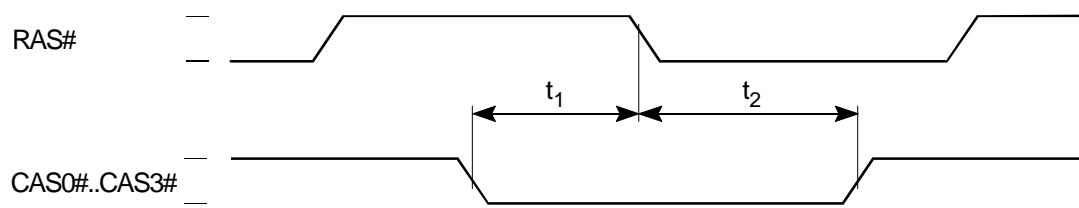

Figure 6.13: DRAM CAS-Before-RAS Refresh

Symbol	Description	Formula
t_1	CAS0#..CAS3# setup time (min.)	at precharge time = 1 cycle: $t_{CLKWH} + 1.4 \text{ ns} + \Delta t_N (a) - \Delta t_N (b)$ at precharge time > 1 cycle: $t_{CLK} + t_{CLKWH} + 1.4 \text{ ns} + \Delta t_N (a) - \Delta t_N (b)$ Note: (a) refers to capacitive load on signal RAS# (b) refers to capacitive load on signals CAS0#..CAS3#
t_2	CAS0#..CAS3# hold time (min.)	(number of RAS to CAS delay cycles + access cycles -1) $\times t_{CLK}$ $+ t_{CLKWL} - 2.5 \text{ ns} + \Delta t_N (a) - \Delta t_N (b)$ Note: (a) refers to capacitive load on signals CAS0#..CAS3# (b) refers to capacitive load on signal RAS#

6.11.5 SRAM Access

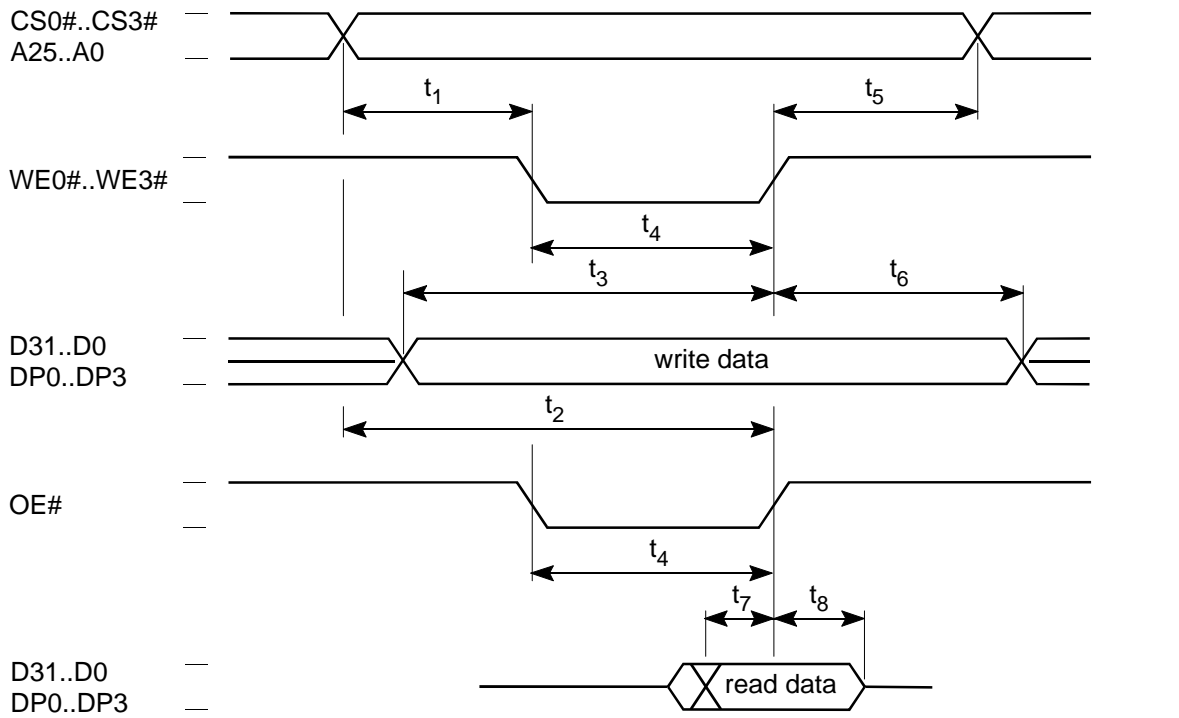

Figure 6.14: SRAM Access

Note: If Mem 0 is not a DRAM type memory, the signal pin RAS# is used as chip select CS0#.

6.11.5.1 Multi-Cycle Access

Symbol	Description	Formula
t_{1a}	A25..A13, CS0#..CS3# setup time to WE0#..WE3#, OE# (min.)	$(\text{number of setup cycles} + 1) \times t_{CLK}$ - 3.2 ns + Δt_P (a) - Δt_N (b)
t_{1b}	Address A12.. A0 setup time to WE0#..WE3#, OE# (min.)	$(\text{number of setup cycles} + 1) \times t_{CLK}$ - 2.3 ns + Δt_P (a) - Δt_P (b)
		Note: (a) refers to capacitive load on signals WE0#.. WE3#, OE# (b) refers to capacitive load on signals A25..A0, CS0#..CS3#

6.11.5.1 Multi-Cycle Access (continued)

Symbol	Description	Formula
t_{2a}	A25..A13, CS0#..CS3# valid before end of WE0#..WE3#, OE# (min.)	(number of setup cycles + access cycles) x t_{CLK} - 2.6 ns + Δt_P (a) - Δt_N (b)
t_{2b}	A12..A0 valid before end of WE0#..WE3#, OE# (min.)	(number of setup cycles + access cycles) x t_{CLK} - 1.7 ns + Δt_P (a) - Δt_P (b)
		Note: (a) refers to capacitive load on signals WE0#..WE3#, OE# (b) refers to capacitive load on signals A25..A0, CS0#..CS3#
t_3	D31..D0, DP0..DP3 valid before end of WE0#..WE3# (min.)	(number of setup cycles + access cycles) x t_{CLK} - 2.7 ns + Δt_P (a) - Δt_N (b)
		Note: (a) refers to capacitive load on signals WE0#..WE3# (b) refers to capacitive load on signal D31..D0, DP0..DP3
t_4	WE0#..WE3#, OE# pulse width low (min.)	(number of access cycles - 1) x t_{CLK} - 0.5 ns
t_{5a}	A25..A13, CS0#..CS3# hold time after WE0#..WE3#, OE# (min.)	(number of bus hold cycles) x t_{CLK} + 1.0 ns + Δt_N (a) - Δt_P (b)
t_{5b}	A12..A0 hold time after WE0#..WE3#, OE# (min.)	(number of bus hold cycles) x t_{CLK} + 0.7 ns + Δt_P (a) - Δt_P (b)
		Note: (a) refers to capacitive load on signals A25..A0, CS0#..CS3# (b) refers to capacitive load on signals WE0#..WE3#, OE#
t_6	D31..D0, DP0..DP3 hold time after WE0#..WE3#	(number of bus hold cycles) x t_{CLK} + 1.1 ns + Δt_N (a) - Δt_P (b)
		Note: (a) refers to capacitive load on signals D31..D0, DP0..DP3 (b) refers to capacitive load on signals WE0#..WE3#
t_7	Read data D31..D0, DP0..DP3 setup time to end of OE# (min.)	0 ns
t_8	Read data D31..D0, DP0..DP3 hold time (min.)	0 ns
		Note: Read data is sampled by the skew-compensated OE# signal and latched internally

6.11.5.2 Single-Cycle Access

Symbol	Description	Formula
t_{1a}	A25..A13, CS0#..CS3# setup time to WE0#..WE3#, OE# (min.)	(number of setup cycles) $\times t_{CLK} + t_{CLKWH}$ - 4.1 ns + Δt_P (a) - Δt_N (b)
t_{1b}	A12..A0 setup time to WE0#..WE3#, OE# (min.)	(number of setup cycles) $\times t_{CLK} + t_{CLKWH}$ - 3.2 ns + Δt_P (a) - Δt_P (b)
		Note: (a) refers to capacitive load on signals WE0#..WE3#, OE# (b) refers to capacitive load on signals A25..A0, CS0#..CS3#
t_{2a}	A25..A13, CS0#..CS3# valid before end of WE0#..WE3#, OE# (min.)	(number of setup cycles + 1) $\times t_{CLK}$ - 2.6 ns + Δt_P (a) - Δt_N (b)
t_{2b}	A12..A0 valid before end of WE0#..WE3#, OE# (min.)	(number of setup cycles + 1) $\times t_{CLK}$ - 1.7 ns + Δt_P (a) - Δt_P (b)
		Note: (a) refers to capacitive load on signals WE0#..WE3#, OE# (b) refers to capacitive load on signals A25..A0, CS0#..CS3#
t_3	D31..D0, DP0..DP3 valid before end of WE0#..WE3# (min.)	(number of setup cycles + 1) $\times t_{CLK}$ - 2.8 ns + Δt_P (a) - Δt_N (b)
		Note: (a) refers to capacitive load on signals WE0#..WE3# (b) refers to capacitive load on signals D31..D0, DP0..DP3
t_4	WE0#..WE3#, OE# pulse width low (min.)	$t_{CLKWL} + 0.5$ ns
t_{5a}	A25..A13, CS0#..CS3# hold time after WE0#..WE3#, OE# (min.)	(number of bus hold cycles) $\times t_{CLK}$ + 1.1 ns + Δt_N (a) - Δt_P (b)
t_{5b}	A12..A0 hold time after WE0#..WE3#, OE# (min.)	(number of bus hold cycles) $\times t_{CLK}$ + 0.7 ns + Δt_P (a) - Δt_P (b)
		Note: (a) refers to capacitive load on signals A25..A0, CS0#..CS3# (b) refers to capacitive load on signals WE0#..WE3#, OE#
t_6	D31..D0, DP0..DP3 hold time after WE0#..WE3# (min.)	(number of bus hold cycles) $\times t_{CLK}$ + 1.2 ns + Δt_N (a) - Δt_P (b)
		Note: (a) refers to capacitive load on signals D31..D0, DP0..DP3 (b) refers to capacitive load on signals WE0#..WE3#

6.11.5.2 Single-Cycle Access (continued)

Symbol	Description	Formula
t_7	Read data D31..D0, DP0..DP3 setup time to end of OE# (min.)	0 ns
t_8	Read data D31..D0, DP0..DP3 hold time (min.)	0 ns Note: Read data is sampled by the skew-compensated OE# signal and latched internally

6.11.6 I/O Access

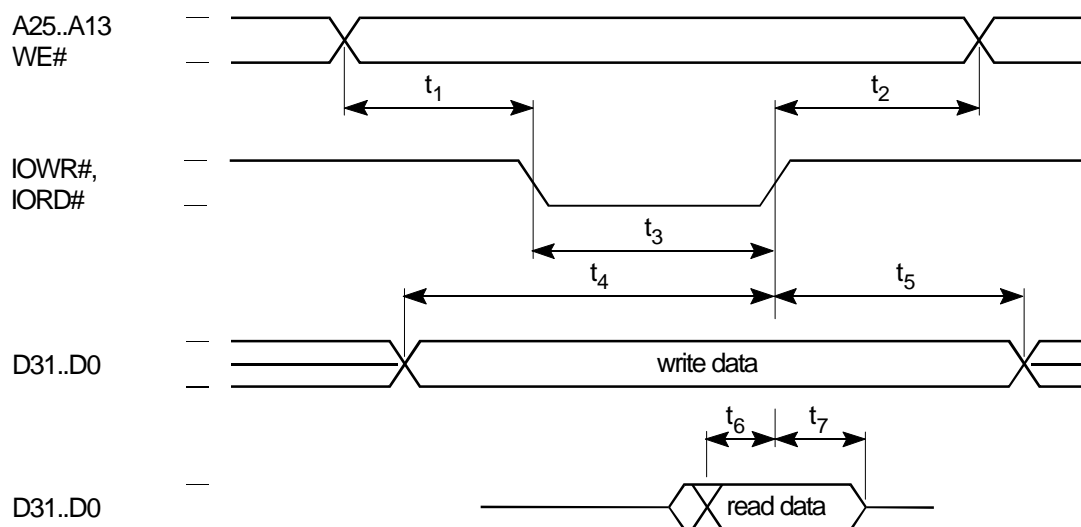

Figure 6.15: I/O Access

Symbol	Description	Formula
t_1	A25..A13, WE# setup time before IOWR#, IORD# (min.)	$(\text{number of setup cycles} + 1) \times t_{\text{CLK}}$ - 1.1 ns + Δt_N (a) - Δt_N (b) Note: (a) refers to capacitive load on signals IOWR#, IORD# (b) refers to capacitive load on signals A25..A13
t_2	A25..A13, WE# hold time after IOWR#, IORD# (min.)	$(\text{number of bus hold cycles}) \times t_{\text{CLK}}$ - 0.5 ns + Δt_N (a) - Δt_N (b) Note: (a) refers to capacitive load on signals A25..A13 (b) refers to capacitive load on signals IOWR#, IORD#
t_3	IOWR#, IORD# pulse width low (min.)	$(\text{number of access cycles} - 1) \times t_{\text{CLK}}$ - 2.0 ns

6.11.6 I/O Access (continued)

Symbol	Description	Formula
t_4	Write data D31..D0 setup time to end of IOWR# (or IORD# if used as data strobe) (min.)	$(\text{number of setup cycles} + \text{access cycles}) \times t_{\text{CLK}}$ $- 1.0 \text{ ns} + \Delta t_N \text{ (a)} - \Delta t_N \text{ (b)}$ Note: (a) refers to capacitive load on signal IOWR# (IORD#) (b) refers to capacitive load on signals D31..D0
t_5	Write data D31..D0 hold time (min)	$(\text{number of bus hold cycles}) \times t_{\text{CLK}}$ $+ 0.1 \text{ ns} + \Delta t_N \text{ (a)} - \Delta t_N \text{ (b)}$ Note: (a) refers to capacitive load on signals D31..D0 (b) refers to capacitive load on signal IOWR# (IORD#)
t_6	Read data D31..D0 setup time to end of IORD# (min.)	0 ns
t_7	Read data D31..D0 hold time (min.)	0 ns Note: Read data is sampled by the skew-compensated IORD# signal and latched internally

7. Mechanical Data

7.1 GMS30C2132, 160-Pin MQFP-Package

7.1.1 Pin Configuration - View from Top Side

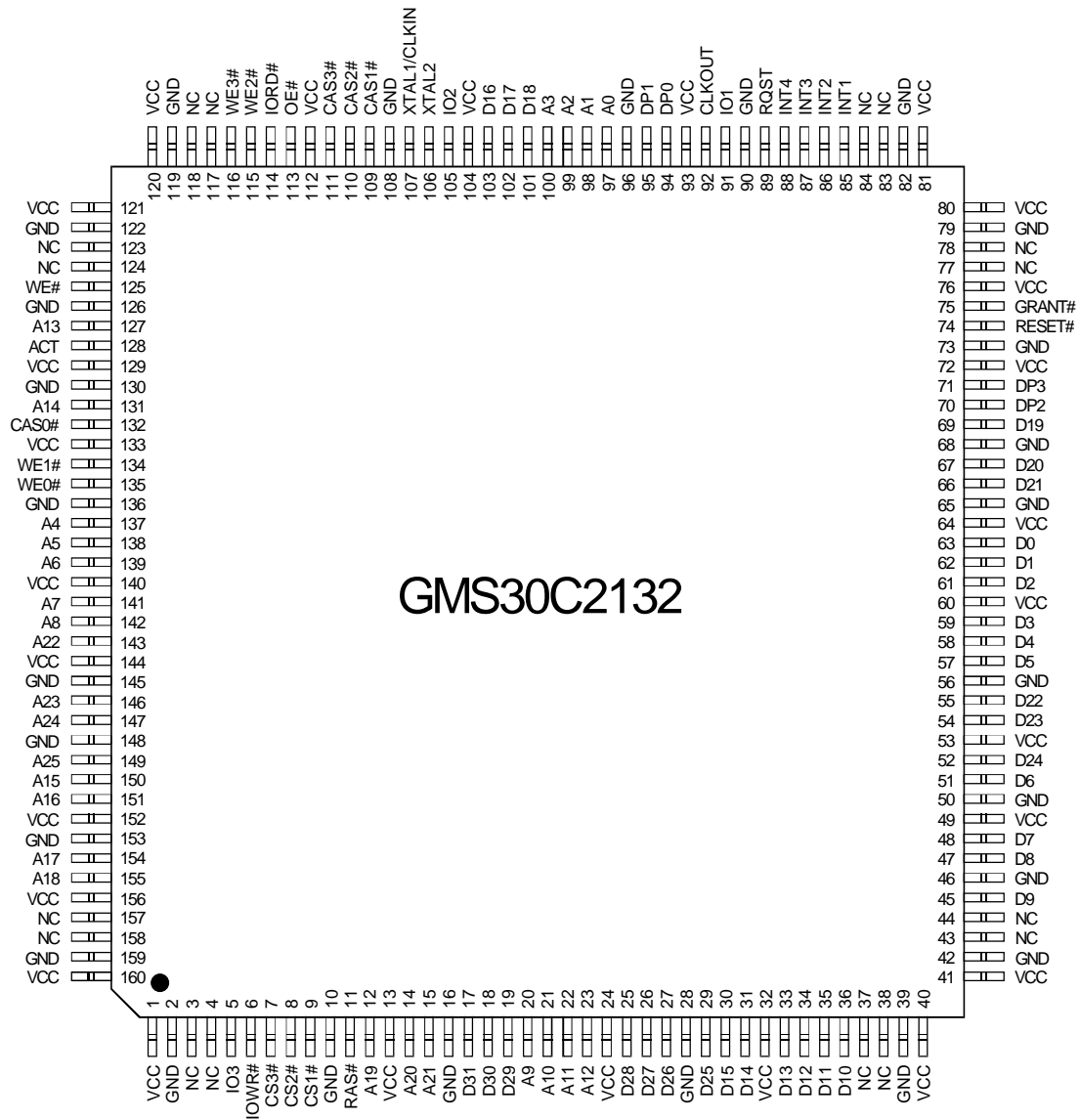

Figure 7.1: GMS30C2132, 160-Pin MQFP-Package

7.1.2 Pin Cross Reference by Pin Name

Signal	Location	Signal	Location	Signal	Location	Signal	Location
A0	97	D5	57	GND	65	NC	124
A1	98	D6	51	GND	68	NC	157
A2	99	D7	48	GND	73	NC	158
A3	100	D8	47	GND	79	OE#	113
A4	137	D9	45	GND	82	RAS#	11
A5	138	D10	36	GND	90	RESET#	74
A6	139	D11	35	GND	96	RQST	89
A7	141	D12	34	GND	108	VCC	1
A8	142	D13	33	GND	119	VCC	13
A9	20	D14	31	GND	122	VCC	24
A10	21	D15	30	GND	126	VCC	32
A11	22	D16	103	GND	130	VCC	40
A12	23	D17	102	GND	136	VCC	41
A13	127	D18	101	GND	145	VCC	49
A14	131	D19	69	GND	148	VCC	53
A15	150	D20	67	GND	153	VCC	60
A16	151	D21	66	GND	159	VCC	64
A17	154	D22	55	GRANT#	75	VCC	72
A18	155	D23	54	INT1	85	VCC	76
A19	12	D24	52	INT2	86	VCC	80
A20	14	D25	29	INT3	87	VCC	81
A21	15	D26	27	INT4	88	VCC	93
A22	143	D27	26	IO1	91	VCC	104
A23	146	D28	25	IO2	105	VCC	112
A24	147	D29	19	IO3	5	VCC	120
A25	149	D30	18	IORD#	114	VCC	121
ACT	128	D31	17	IOWR#	6	VCC	133
CAS0#	132	DP0	94	NC	3	VCC	140
CAS1#	109	DP1	95	NC	4	VCC	156
CAS2#	110	DP2	70	NC	37	VCC	160
CAS3#	111	DP3	71	NC	38	VCC	129
CLKOUT	92	GND	2	NC	43	VCC	144
CS1#	9	GND	10	NC	44	VCC	152
CS2#	8	GND	16	NC	77	WE#	125
CS3#	7	GND	28	NC	78	WE0#	135
D0	63	GND	39	NC	83	WE1#	134
D1	62	GND	42	NC	84	WE2#	115
D2	61	GND	46	NC	117	WE3#	116
D3	59	GND	50	NC	118	XTAL1/CLKIN	107
D4	58	GND	56	NC	123	XTAL2	106

7.1.3 Pin Cross Reference by Location

Location	Signal	Location	Signal	Location	Signal	Location	Signal
1.....	VCC	41.....	VCC	81.....	VCC	121.....	VCC
2.....	GND	42.....	GND	82.....	GND	122.....	GND
3.....	NC	43.....	NC	83.....	NC	123.....	NC
4.....	NC	44.....	NC	84.....	NC	124.....	NC
5.....	IO3	45.....	D9	85.....	INT1	125.....	WE#
6.....	IOWR#	46.....	GND	86.....	INT2	126.....	GND
7.....	CS3#	47.....	D8	87.....	INT3	127.....	A13
8.....	CS2#	48.....	D7	88.....	INT4	128.....	ACT
9.....	CS1#	49.....	VCC	89.....	RQST	129.....	VCC
10.....	GND	50.....	GND	90.....	GND	130.....	GND
11.....	RAS#	51.....	D6	91.....	IO1	131.....	A14
12.....	A19	52.....	D24	92.....	CLKOUT	132.....	CAS0#
13.....	VCC	53.....	VCC	93.....	VCC	133.....	VCC
14.....	A20	54.....	D23	94.....	DP0	134.....	WE1#
15.....	A21	55.....	D22	95.....	DP1	135.....	WE0#
16.....	GND	56.....	GND	96.....	GND	136.....	GND
17.....	D31	57.....	D5	97.....	A0	137.....	A4
18.....	D30	58.....	D4	98.....	A1	138.....	A5
19.....	D29	59.....	D3	99.....	A2	139.....	A6
20.....	A9	60.....	VCC	100.....	A3	140.....	VCC
21.....	A10	61.....	D2	101.....	D18	141.....	A7
22.....	A11	62.....	D1	102.....	D17	142.....	A8
23.....	A12	63.....	D0	103.....	D16	143.....	A22
24.....	VCC	64.....	VCC	104.....	VCC	144.....	VCC
25.....	D28	65.....	GND	105.....	IO2	145.....	GND
26.....	D27	66.....	D21	106.....	XTAL2	146.....	A23
27.....	D26	67.....	D20	107.....	XTAL1/CLKIN	147.....	A24
28.....	GND	68.....	GND	108.....	GND	148.....	GND
29.....	D25	69.....	D19	109.....	CAS1#	149.....	A25
30.....	D15	70.....	DP2	110.....	CAS2#	150.....	A15
31.....	D14	71.....	DP3	111.....	CAS3#	151.....	A16
32.....	VCC	72.....	VCC	112.....	VCC	152.....	VCC
33.....	D13	73.....	GND	113.....	OE#	153.....	GND
34.....	D12	74.....	RESET#	114.....	IORD#	154.....	A17
35.....	D11	75.....	GRANT#	115.....	WE2#	155.....	A18
36.....	D10	76.....	VCC	116.....	WE3#	156.....	VCC
37.....	NC	77.....	NC	117.....	NC	157.....	NC
38.....	NC	78.....	NC	118.....	NC	158.....	NC
39.....	GND	79.....	GND	119.....	GND	159.....	GND
40.....	VCC	80.....	VCC	120.....	VCC	160.....	VCC

7.2 GMS30C2132, 144-Pin TQFP-Package

7.2.1 Pin Configuration - View from Top Side

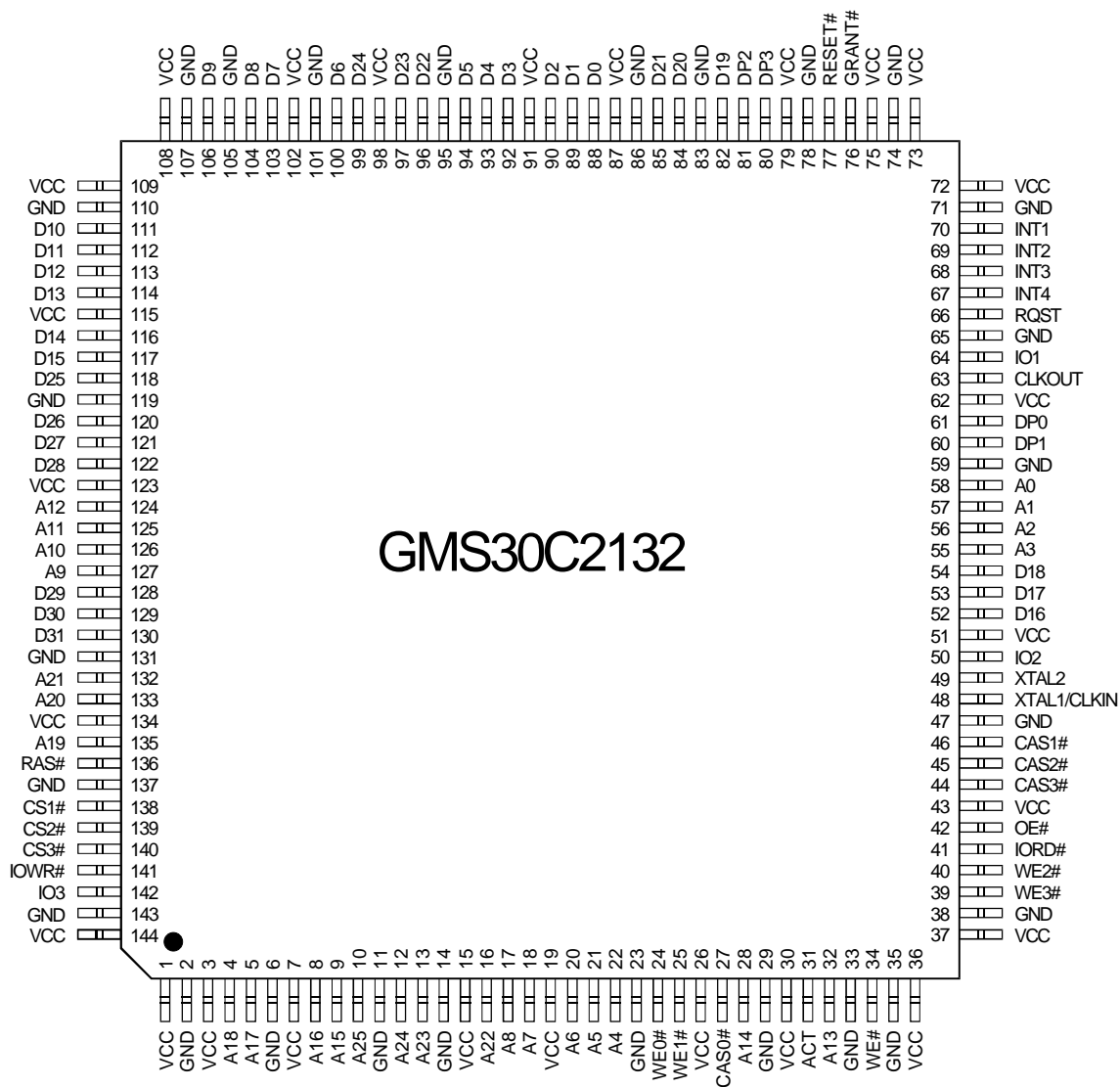

Figure 7.2: GMS30C2132, 144-Pin TQFP-Package

7.2.2 Pin Cross Reference by Pin Name

Signal	Location	Signal	Location	Signal	Location	Signal	Location
A0.....	58	D1	89	GND	6	RAS#	136
A1.....	57	D2	90	GND	11	RESET#.....	77
A2.....	56	D3	92	GND	14	RQST.....	66
A3.....	55	D4	93	GND	23	VCC	1
A4.....	22	D5	94	GND	29	VCC	3
A5.....	21	D6	100	GND	33	VCC	7
A6.....	20	D7	103	GND	35	VCC	15
A7.....	18	D8	104	GND	38	VCC	19
A8.....	17	D9	106	GND	47	VCC	26
A9.....	127	D10	111	GND	59	VCC	30
A10.....	126	D11	112	GND	65	VCC	36
A11.....	125	D12	113	GND	71	VCC	37
A12.....	124	D13	114	GND	74	VCC	43
A13.....	32	D14	116	GND	78	VCC	51
A14.....	28	D15	117	GND	83	VCC	62
A15.....	9	D16	52	GND	86	VCC	72
A16.....	8	D17	53	GND	95	VCC	73
A17.....	5	D18	54	GND	101	VCC	75
A18.....	4	D19	82	GND	105	VCC	79
A19.....	135	D20	84	GND	107	VCC	87
A20.....	133	D21	85	GND	110	VCC	91
A21.....	132	D22	96	GND	119	VCC	98
A22.....	16	D23	97	GND	131	VCC	102
A23.....	13	D24	99	GND	137	VCC	108
A24.....	12	D25	118	GND	143	VCC	109
A25.....	10	D26	120	GRANT#.....	76	VCC	115
ACT.....	31	D27	121	INT1.....	70	VCC	123
CAS0#.....	27	D28	122	INT2.....	69	VCC	134
CAS1#.....	46	D29	128	INT3.....	68	VCC	144
CAS2#.....	45	D30	129	INT4.....	67	WE#.....	34
CAS3#.....	44	D31	130	IO1.....	64	WE0#.....	24
CLKOUT.....	63	DP0.....	61	IO2.....	50	WE1#.....	25
CS1#.....	138	DP1.....	60	IO3.....	142	WE2#.....	40
CS2#.....	139	DP2.....	81	IORD#.....	41	WE3#.....	39
CS3#.....	140	DP3.....	80	IOWR#.....	141	XTAL1/CLKIN ...	48
D0.....	88	GND	2	OE#.....	42	XTAL2.....	49

7.2.3 Pin Cross Reference by Location

Location	Signal	Location	Signal	Location	Signal	Location	Signal
1	VCC	37	VCC	73	VCC	109	VCC
2	GND	38	GND	74	GND	110	GND
3	VCC	39	WE3#	75	VCC	111	D10
4	A18	40	WE2#	76	GRANT#	112	D11
5	A17	41	IORD#	77	RESET#	113	D12
6	GND	42	OE#	78	GND	114	D13
7	VCC	43	VCC	79	VCC	115	VCC
8	A16	44	CAS3#	80	DP3	116	D14
9	A15	45	CAS2#	81	DP2	117	D15
10	A25	46	CAS1#	82	D19	118	D25
11	GND	47	GND	83	GND	119	GND
12	A24	48	XTAL1/CLKIN	84	D20	120	D26
13	A23	49	XTAL2	85	D21	121	D27
14	GND	50	IO2	86	GND	122	D28
15	VCC	51	VCC	87	VCC	123	VCC
16	A22	52	D16	88	D0	124	A12
17	A8	53	D17	89	D1	125	A11
18	A7	54	D18	90	D2	126	A10
19	VCC	55	A3	91	VCC	127	A9
20	A6	56	A2	92	D3	128	D29
21	A5	57	A1	93	D4	129	D30
22	A4	58	A0	94	D5	130	D31
23	GND	59	GND	95	GND	131	GND
24	WE0#	60	DP1	96	D22	132	A21
25	WE1#	61	DP0	97	D23	133	A20
26	VCC	62	VCC	98	VCC	134	VCC
27	CAS0#	63	CLKOUT	99	D24	135	A19
28	A14	64	IO1	100	D6	136	RAS#
29	GND	65	GND	101	GND	137	GND
30	VCC	66	RQST	102	VCC	138	CS1#
31	ACT	67	INT4	103	D7	139	CS2#
32	A13	68	INT3	104	D8	140	CS3#
33	GND	69	INT2	105	GND	141	IOWR#
34	WE#	70	INT1	106	D9	142	IO3
35	GND	71	GND	107	GND	143	GND
36	VCC	72	VCC	108	VCC	144	VCC

7.3 GMS30C2116, 100-Pin TQFP-Package

7.3.1 Pin Configuration - View from Top Side

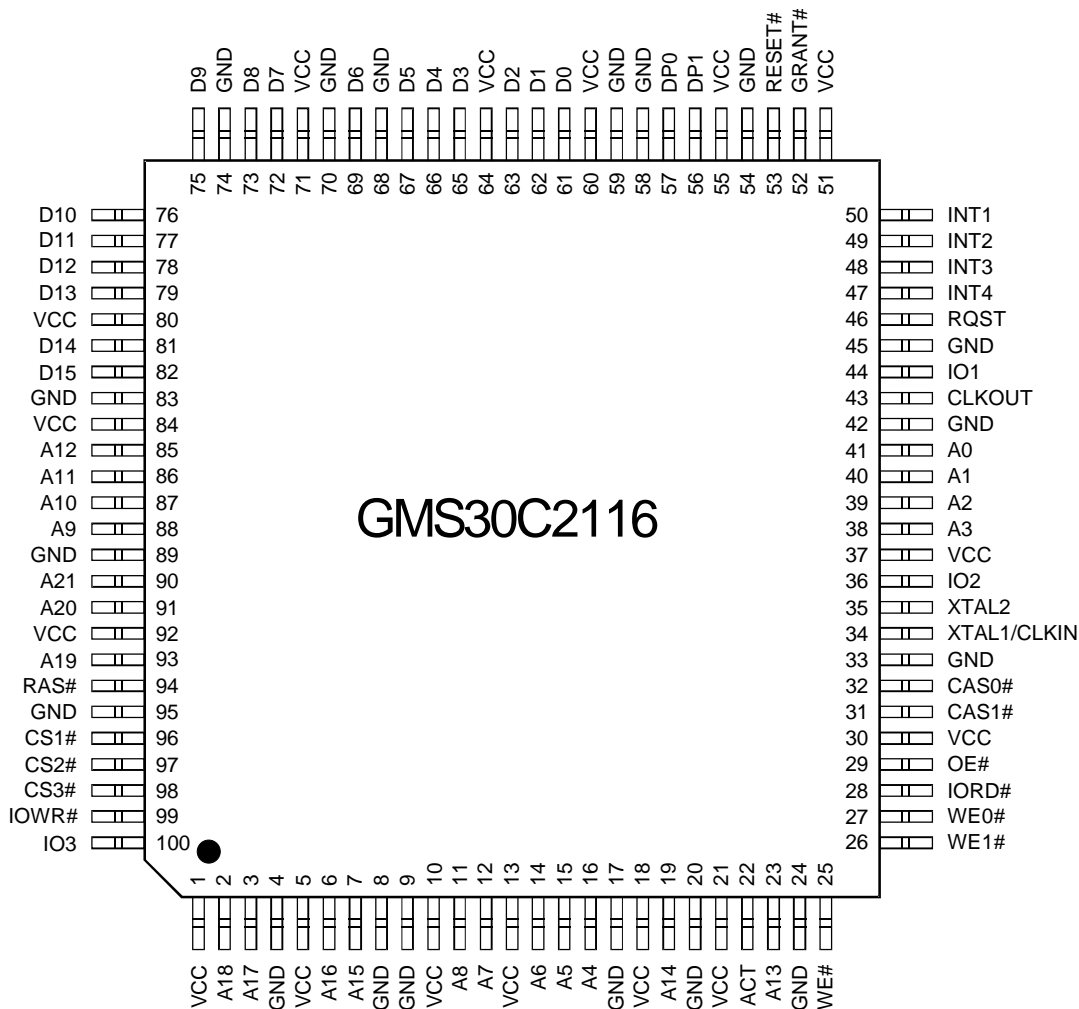

Figure 7.3: GMS30C2116, 100-Pin TQFP-Package

7.3.2 Pin Cross Reference by Pin Name

Signal	Location	Signal	Location	Signal	Location	Signal	Location
A0	41	CLKOUT	43	GND	17	OE#	29
A1	40	CS1#	96	GND	20	RAS#	94
A2	39	CS2#	97	GND	24	RESET#	53
A3	38	CS3#	98	GND	33	RQST	46
A4	16	D0	61	GND	42	VCC	1
A5	15	D1	62	GND	45	VCC	5
A6	14	D2	63	GND	54	VCC	10
A7	12	D3	65	GND	58	VCC	13
A8	11	D4	66	GND	59	VCC	18
A9	88	D5	67	GND	68	VCC	21
A10	87	D6	69	GND	70	VCC	30
A11	86	D7	72	GND	74	VCC	37
A12	85	D8	73	GND	83	VCC	51
A13	23	D9	75	GND	89	VCC	55
A14	19	D10	76	GND	95	VCC	60
A15	7	D11	77	GRANT#	52	VCC	64
A16	6	D12	78	INT1	50	VCC	71
A17	3	D13	79	INT2	49	VCC	80
A18	2	D14	81	INT3	48	VCC	84
A19	93	D15	82	INT4	47	VCC	92
A20	91	DP0	57	IO1	44	WE#	25
A21	90	DP1	56	IO2	36	WE0#	27
ACT	22	GND	4	IO3	100	WE1#	26
CAS0#	32	GND	8	IORD#	28	XTAL1/CLKIN	34
CAS1#	31	GND	9	IOWR#	99	XTAL2	35

7.3.3 Pin Cross Reference by Location

Location	Signal	Location	Signal	Location	Signal	Location	Signal
1.....	VCC	26.....	WE1#	51.....	VCC	76.....	D10
2.....	A18	27.....	WE0#	52.....	GRANT#	77.....	D11
3.....	A17	28.....	IORD#	53.....	RESET#	78.....	D12
4.....	GND	29.....	OE#	54.....	GND	79.....	D13
5.....	VCC	30.....	VCC	55.....	VCC	80.....	VCC
6.....	A16	31.....	CAS1#	56.....	DP1	81.....	D14
7.....	A15	32.....	CAS0#	57.....	DP0	82.....	D15
8.....	GND	33.....	GND	58.....	GND	83.....	GND
9.....	GND	34.....	XTAL1/CLKIN	59.....	GND	84.....	VCC
10.....	VCC	35.....	XTAL2	60.....	VCC	85.....	A12
11.....	A8	36.....	IO2	61.....	D0	86.....	A11
12.....	A7	37.....	VCC	62.....	D1	87.....	A10
13.....	VCC	38.....	A3	63.....	D2	88.....	A9
14.....	A6	39.....	A2	64.....	VCC	89.....	GND
15.....	A5	40.....	A1	65.....	D3	90.....	A21
16.....	A4	41.....	A0	66.....	D4	91.....	A20
17.....	GND	42.....	GND	67.....	D5	92.....	VCC
18.....	VCC	43.....	CLKOUT	68.....	GND	93.....	A19
19.....	A14	44.....	IO1	69.....	D6	94.....	RAS#
20.....	GND	45.....	GND	70.....	GND	95.....	GND
21.....	VCC	46.....	RQST	71.....	VCC	96.....	CS1#
22.....	ACT	47.....	INT4	72.....	D7	97.....	CS2#
23.....	A13	48.....	INT3	73.....	D8	98.....	CS3#
24.....	GND	49.....	INT2	74.....	GND	99.....	IOWR#
25.....	WE#	50.....	INT1	75.....	D9	100.....	IO3

7.4 Package-Dimensions

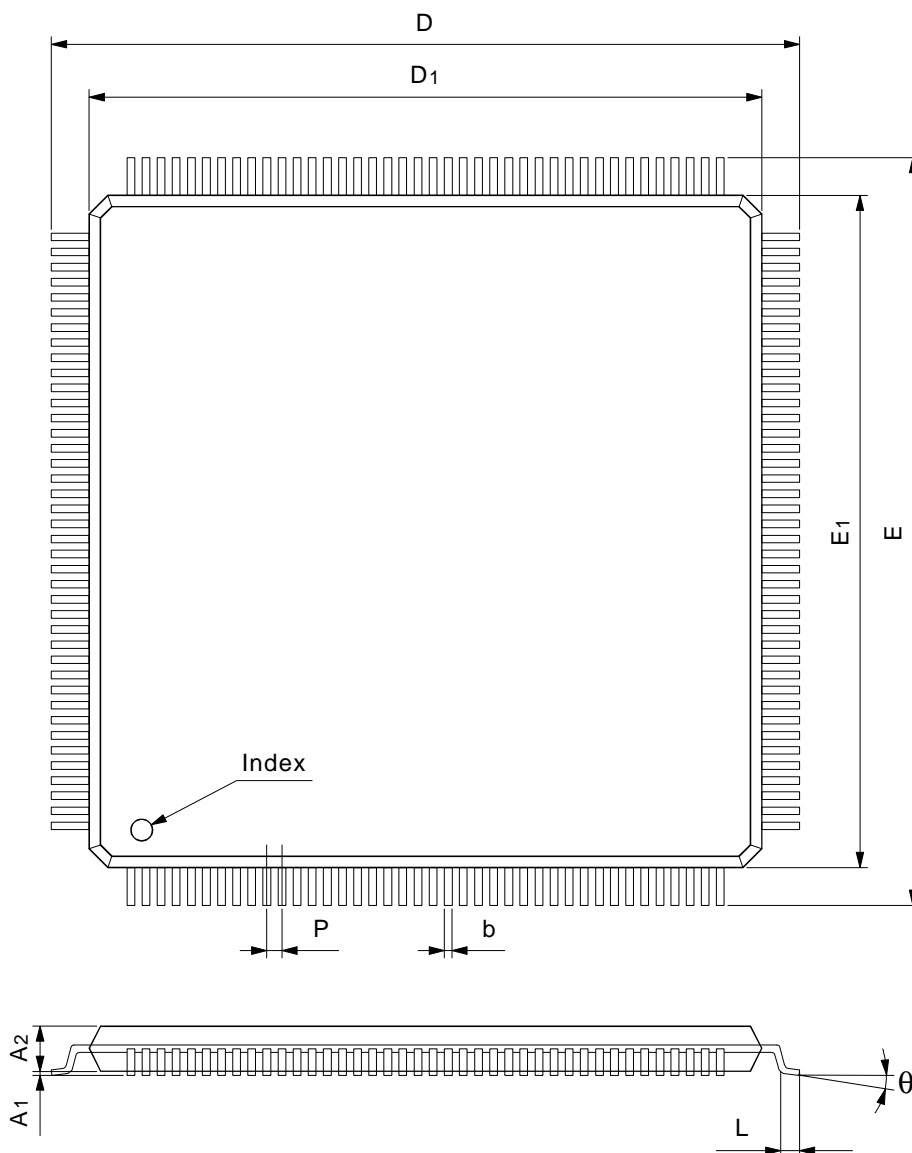

Figure 7.4: GMS30C2132, GMS30C2116 Package-Outline

Symbol	Term	Definition
A1	Standoff height	Height from ground plane to bottom edge of package
A2	Package height	Height of package itself
E, D	Overall length & width	Length and width including leads
D1, E1	Package length & width	Length and width of package
L	Length of flat lead section	Length of flat lead section
P	Lead pitch	Lead pitch
b	Lead width	Width of a lead
θ	Lead angle	Angle of lead versus seating plane

7.4 Package-Dimensions (continued)

GMS30C2132, 160-Pin MQFP-Package

Symbol	Dimensions in Millimeters			Dimensions in Inches		
	Min.	Nom.	Max.	Min.	Nom.	Max
A1	0.25	0.36	0.47	(0.010)	(0.014)	(0.018)
A2	3.20	3.40	3.60	(0.126)	(0.134)	(0.142)
E, D	31.20	31.90	32.15	(1.228)	(1.256)	(1.266)
E1, D1	27.90	28.00	28.10	(1.098)	(1.102)	(1.106)
L	0.63	0.88	1.03	(0.025)	(0.035)	(0.041)
P		0.65			(0.0256)	
b	0.22	0.29	0.38	(0.009)	(0.012)	(0.015)
θ	0°		7°	(0°)		(7°)

GMS30C2132, 144-Pin TQFP-Package

Symbol	Dimensions in Millimeters			Dimensions in Inches		
	Min.	Nom.	Max.	Min.	Nom.	Max
A1	0.05	0.10	0.15	(0.002)	(0.004)	(0.006)
A2	1.35	1.40	1.45	(0.053)	(0.055)	(0.057)
E, D	21.80	22.00	22.20	(0.858)	(0.866)	(0.874)
E1, D1	19.90	20.00	20.10	(0.783)	(0.787)	(0.791)
L	0.45	0.60	0.75	(0.018)	(0.024)	(0.030)
P		0.50			(0.0197)	
b	0.17	0.22	0.27	(0.007)	(0.009)	(0.011)
θ	0°		7°	(0°)		(7°)

7.4 Package-Dimensions (continued)

GMS30C2116, 100-Pin TQFP-Package

Symbol	Dimensions in Millimeters			Dimensions in Inches		
	Min.	Nom.	Max.	Min.	Nom.	Max
A1	0.05	0.10	0.15	(0.002)	(0.004)	(0.006)
A2	1.35	1.40	1.45	(0.053)	(0.055)	(0.057)
E, D	15.80	16.00	16.20	(0.622)	(0.630)	(0.638)
E1, D1	13.90	14.00	14.10	(0.547)	(0.551)	(0.555)
L	0.45	0.60	0.75	(0.018)	(0.024)	(0.030)
P		0.50			(0.0197)	
b	0.17	0.22	0.27	(0.007)	(0.009)	(0.011)
θ	0°		7°	(0°)		(7°)

Appendix. Instruction Set Details

This appendix provides a detailed description of the operation of each GMS30C2116/32 RISC/DSP instruction. The instructions are listed in alphabet order.

The exceptions that may occur due to the execution of each instruction are listed after the description of each instruction. The description of the immediate causes and manner of handling exceptions is omitted from the instruction description in this chapter. Refer to chapter 4 for detailed description of exceptions and handling.

Instruction Classes

GMS30C2116/32 RISC/DSP instructions are divided into 7 classes

1. Memory Instruction: Load data form memory in a register or store data from a register to memory. I/O devices are also addressed by memory instructions.
2. Move Instruction: Source operand or the immediate operand is copied to the destination register.
3. Computational Instruction: Perform arithmetic, logical, shift and rotate operations on values in registers.
4. Branch and Delayed Branch Instruction: When the branch condition is met, place the branch address $PC+rel$ in the program counter PC and clear the cache-mode flag M.
5. Extended DSP Instruction: The extended DSP functions use the on-chip multiply-accumulate unit.
6. Software Instruction: Cause a branch to the subprogram associated with each Software instruction.
7. Special Instruction: Call, Trap, Frame, Return and Fetch instruction

Instruction Notation

Instruction notation is same as the notation of using chapter 2 and 3. (see section 2.1 Instruction Notation)

ADD**ADD**

Format:

RR format

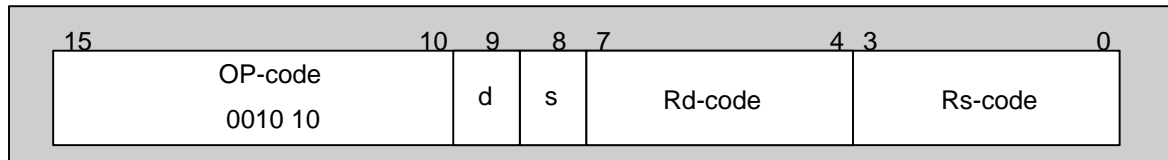

s = 0: Rs-code encoded G0..G15 for Rs

s = 1: Rs-code encoded L0..L15 for Rs

d = 0: Rd-code encoded G0..G15 for Rd

d = 1: Rd-code encoded L0..L15 for Rd

Notation:

ADD Rd, Rs

ADD Rd, C (when SR is denoted as a Rs)

Description:

The source operand (Rs) is added to the destination operand (Rd), the result is placed in the destination register (Rd) and the condition flag are set or cleared accordingly.

Both operands and the result are interpreted as either all signed or all unsigned integers.

When the SR is denoted as a source operand, carry flag C is added instead of the SR.

Operation:

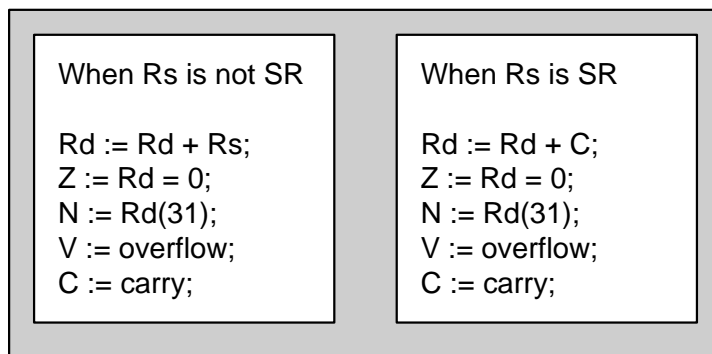

Exceptions:

None.

ADD with carry**ADDC**

Format:

RR format

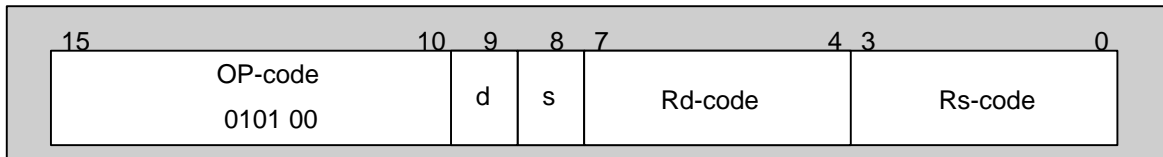

s = 0: Rs-code encoded G0..G15 for Rs
 s = 1: Rs-code encoded L0..L15 for Rs
 d = 0: Rd-code encoded G0..G15 for Rd
 d = 1: Rd-code encoded L0..L15 for Rd

Notation:

ADDC Rd, Rs

ADDC Rd, C (when SR is denoted as a Rs)

Description:

The source operand (Rs) + C is added to the destination operand (Rd), the result is placed in the destination register (Rd) and the condition flag are set or cleared accordingly.

Both operands and the result are interpreted as either all signed or all unsigned integers.

When the SR is denoted as a source operand, carry flag C is added instead of the SR.

Operation:

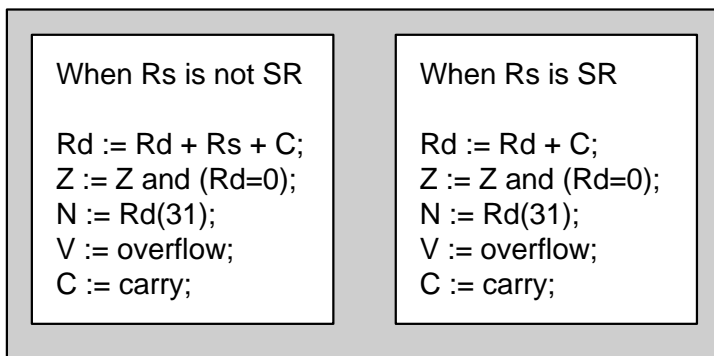

Exceptions:

None.

ADD Immediate**ADDI**

Format:

Rimm format

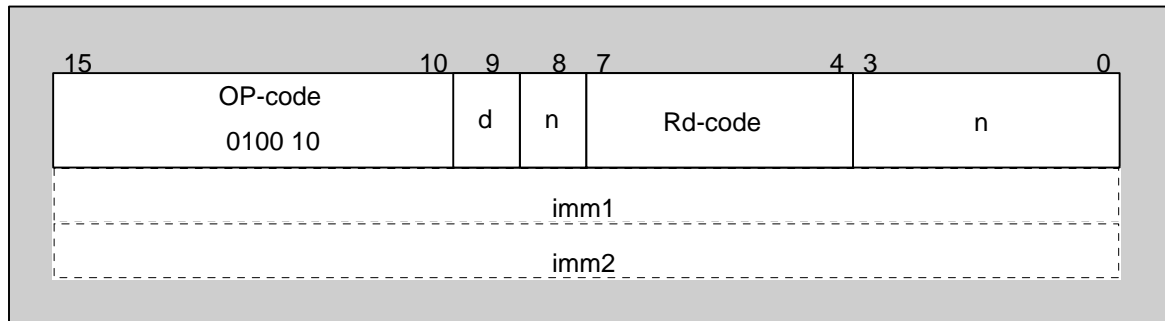

d = 0: Rd-code encoded G0..G15 for Rd

d = 1: Rd-code encoded L0..L15 for Rd

n: bit 8 // bit 3..0 encode n = 0..31, see Table 2.3 Encoding of Immediate Values

Notation:

ADDI Rd, imm

ADDI Rd, CZ (when n = 0)

Description:

The immediate operand (imm) is added to the destination operand (Rd), the result is placed in the destination register (Rd) and the condition flag are set or cleared accordingly.

Both operands and the result are interpreted as either all signed or all unsigned integers.

When the immediate value n = 0, C is only added to the destination operand if Z = 0 or Rd(0) is one (round to even).

Operation:

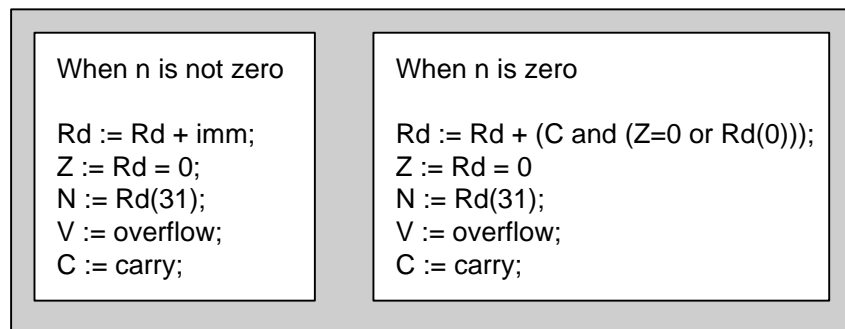

Exceptions:

None.

Signed ADD with trap**ADDS**

Format:

RR format

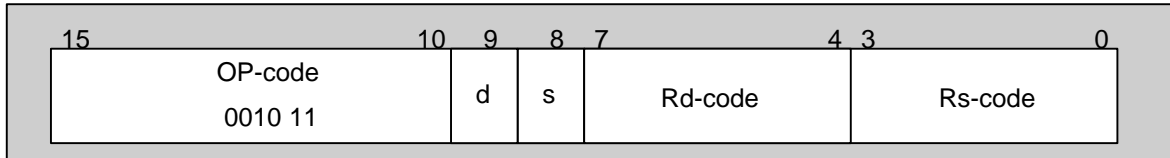

s = 0: Rs-code encoded G0..G15 for Rs
s = 1: Rs-code encoded L0..L15 for Rs
d = 0: Rd-code encoded G0..G15 for Rd
d = 1: Rd-code encoded L0..L15 for Rd

Notation:

ADDS Rd, Rs

ADDS Rd, C (when SR is denoted as a Rs)

Description:

The source operand (Rs) is added to the destination operand (Rd), the result is placed in the destination register (Rd) and the condition flag are set or cleared accordingly.

Both operands and the result are signed integers and a trap to Range Error occurs at overflow.

When the SR is denoted as a source operand, carry flag C is added instead of the SR.

Operation:

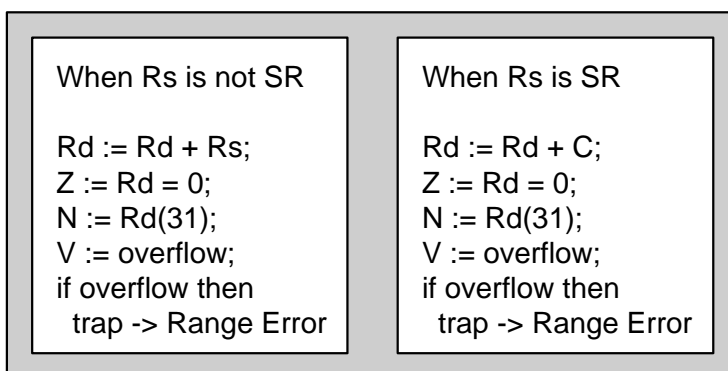

Exceptions:

Overflow exception (trap to Range Error).

Signed ADD Immediate with trap**ADDSI**

Format:

Rimm format

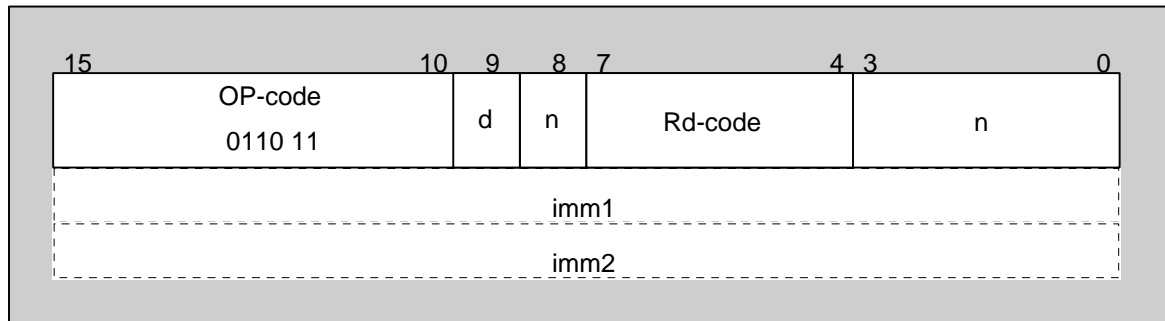

d = 0: Rd-code encoded G0..G15 for Rd

d = 1: Rd-code encoded L0..L15 for Rd

n: bit 8 // bit 3..0 encode n = 0..31, see Table 2.3 Encoding of Immediate Values

Notation:

ADDSI Rd, imm

ADDSI Rd, CZ (when n = 0)

Description:

The immediate operand (imm) is added to the destination operand (Rd), the result is placed in the destination register (Rd) and the condition flag are set or cleared accordingly.

Both operands and the result are signed integers and a trap to Range Error occurs at overflow.

When the immediate value n = 0, C is only added to the destination operand if Z = 0 or Rd(0) is one (round to even).

Operation:

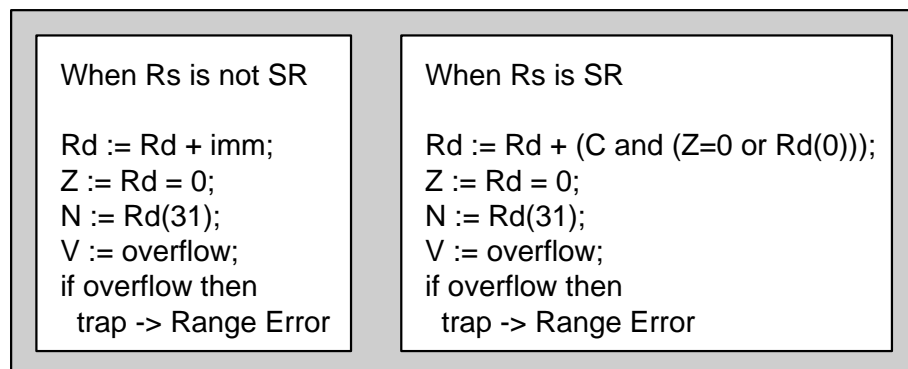

Exceptions:

Overflow exception (trap to Range Error)

AND**AND**

Format:

RR format

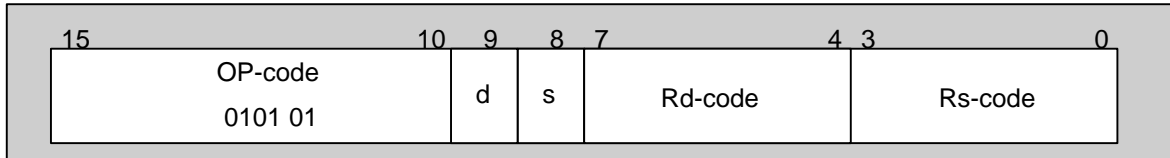

s = 0: Rs-code encoded G0..G15 for Rs
 s = 1: Rs-code encoded L0..L15 for Rs
 d = 0: Rd-code encoded G0..G15 for Rd
 d = 1: Rd-code encoded L0..L15 for Rd

Notation:

AND Rd, Rs

Description:

The result of a bitwise logical AND of the source operand (Rs) and the destination operand (Rd) is placed in the destination register (Rd) and the Z flag is set or cleared accordingly.

Operation:

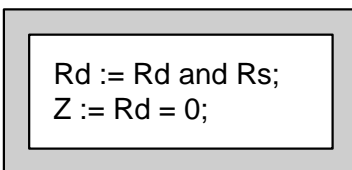

Exceptions:

None.

AND with source used inverted**ANDN**

Format:

RR format

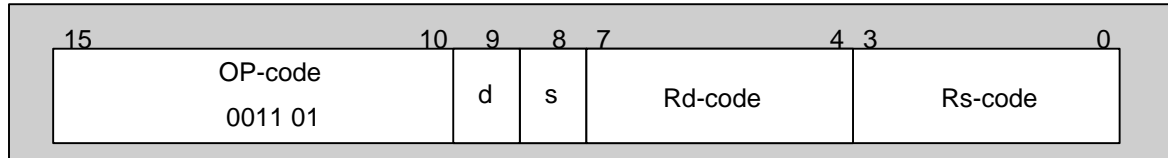

s = 0: Rs-code encoded G0..G15 for Rs

s = 1: Rs-code encoded L0..L15 for Rs

d = 0: Rd-code encoded G0..G15 for Rd

d = 1: Rd-code encoded L0..L15 for Rd

Notation:

ANDN Rd, Rs

Description:

The result of a bitwise logical AND not (ANDN) of the source operand (Rs) and the destination operand (Rd) is placed in the destination register (Rd) and the Z flag is set or cleared accordingly. The source operand is used inverted (itself remaining unchanged).

Operation:

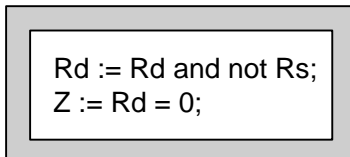

Exceptions:

None.

AND with imm used inverted**ANDNI**

Format:

Rimm format

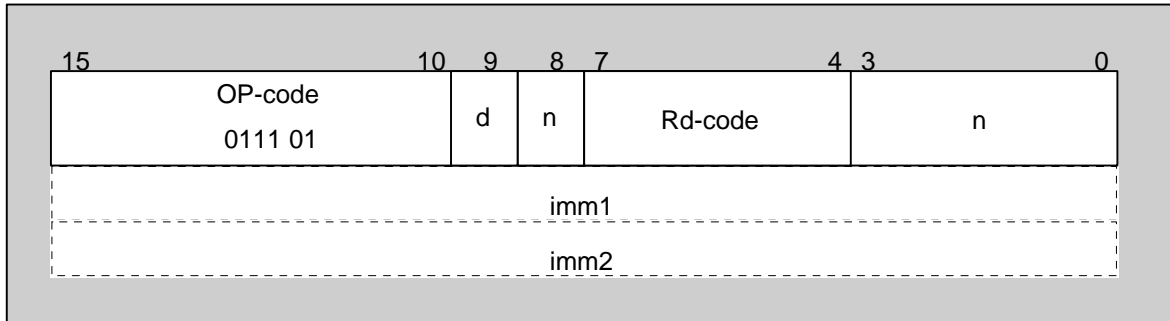

d = 0: Rd-code encoded G0..G15 for Rd

d = 1: Rd-code encoded L0..L15 for Rd

n: bit 8 // bit 3..0 encode n = 0..31, see Table 2.3 Encoding of Immediate Values

Notation:

ANDNI Rd, imm

Description:

The result of a bitwise logical AND not (ANDN) of the source operand (Rs) and the immediate operand (Rd) is placed in the destination register (Rd) and the Z flag is set or cleared accordingly. The immediate operand is used inverted (itself remaining unchanged).

Operation:

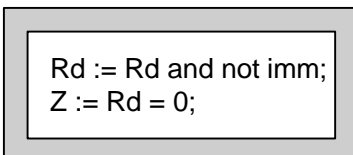

Exceptions:

None.

Branch on Carry**BC**

Format:

PCrel format

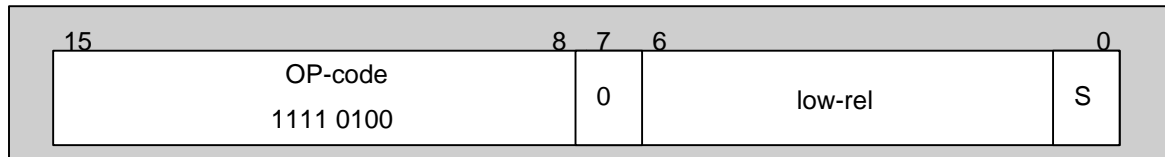

S: sign bit of rel

rel = 25 S // low-rel // 0

range -128 ~ 126

Notation:

BC rel

Description:

If the carry flag C is set ($C = 1$), place the branch address $PC + rel$ (relative of the first byte after the Branch instruction) in the program counter PC and clear the cache-mode flag M ; all condition flags remain unchanged. Then instruction execution proceeds at the branch address placed in the PC .

When the branch condition is not met, the M flag and the condition flags remain unchanged and instruction execution proceeds sequentially.

Note: rel is signed to allow forward or backward branches.

Operation:

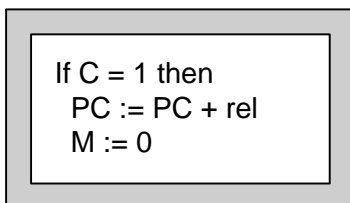

Exceptions:

None.

Branch on Equal**BE**

Format:

PCrel format

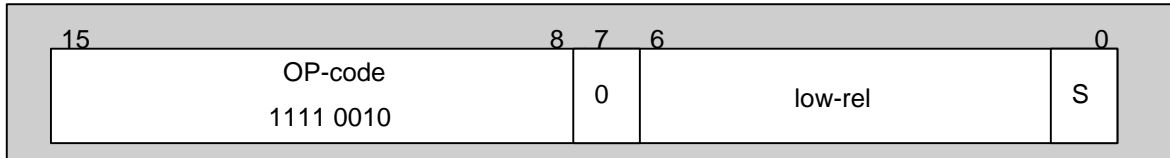

S: sign bit of rel

rel = 25 S // low-rel // 0

range -128 ~ 126

Notation:

BE rel

Description:

If the zero flag is set ($Z = 1$), place the branch address $PC + rel$ (relative of the first byte after the Branch instruction) in the program counter PC and clear the cache-mode flag M; all condition flags remain unchanged. Then instruction execution proceeds at the branch address placed in the PC

When the branch condition is not met, the M flag and the condition flags remain unchanged and instruction execution proceeds sequentially.

Note: rel is signed to allow forward or backward branches.

Operation:

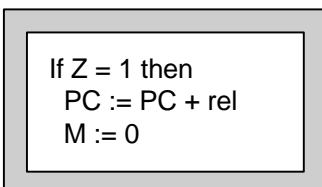

Exceptions:

None.

Branch on Greater or Equal**BGE**

Format:

PCrel format

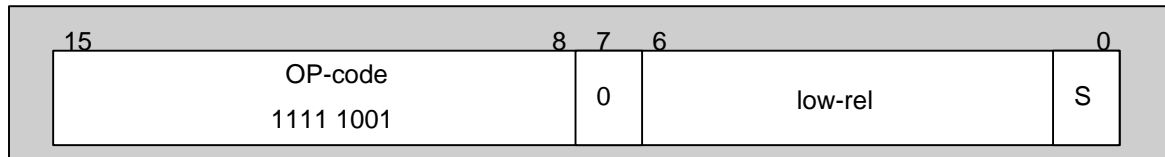

S: sign bit of rel

rel = 25 S // low-rel // 0

range -128 ~ 126

Notation:

BGE rel

Description:

If the negative flag N is cleared (N = 0, non-negative), place the branch address PC + rel (relative of the first byte after the Branch instruction) in the program counter PC and clear the cache-mode flag M; all condition flags remain unchanged. Then instruction execution proceeds at the branch address placed in the PC

When the branch condition is not met, the M flag and the condition flags remain unchanged and instruction execution proceeds sequentially.

Note: rel is signed to allow forward or backward branches.

Operation:

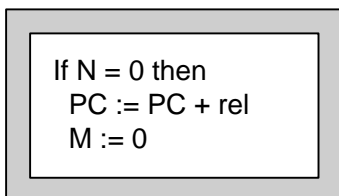

Exceptions:

None.

Branch on Greater Than**BGT**

Format:

PCrel format

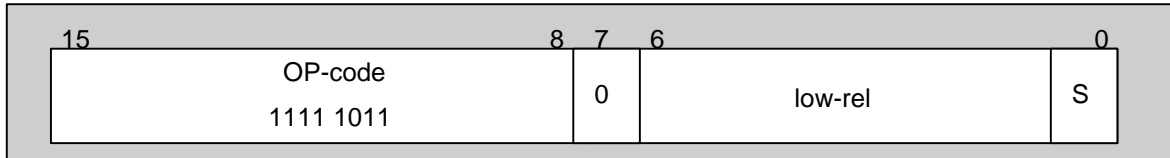

S: sign bit of rel

rel = 25 S // low-rel // 0

range -128 ~ 126

Notation:

BGT rel

Description:

If the negative flag N and the zero flag Z are cleared ($N = 0$ and $Z = 0$), place the branch address $PC + rel$ (relative of the first byte after the Branch instruction) in the program counter PC and clear the cache-mode flag M; all condition flags remain unchanged. Then instruction execution proceeds at the branch address placed in the PC

When the branch condition is not met, the M flag and the condition flags remain unchanged and instruction execution proceeds sequentially.

Note: rel is signed to allow forward or backward branches.

Operation:

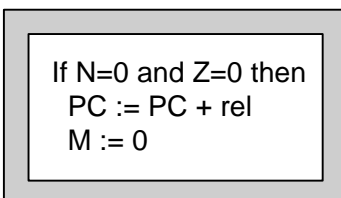

Exceptions:

None.

Branch on Higher or Equal**BHE**

Format:

PCrel format

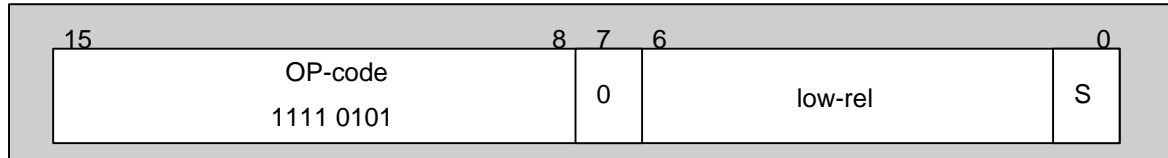

S: sign bit of rel
 rel = 25 S // low-rel // 0
 range -128 ~ 126

Notation:

BHE rel

Description:

If the carry flag C is cleared ($C = 0$), place the branch address $PC + rel$ (relative of the first byte after the Branch instruction) in the program counter PC and clear the cache-mode flag M ; all condition flags remain unchanged. Then instruction execution proceeds at the branch address placed in the PC

When the branch condition is not met, the M flag and the condition flags remain unchanged and instruction execution proceeds sequentially.

Note: rel is signed to allow forward or backward branches.

Operation:

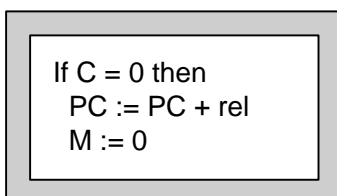

Exceptions:

None.

Branch on Higher Than**BHT**

Format:

PCrel format

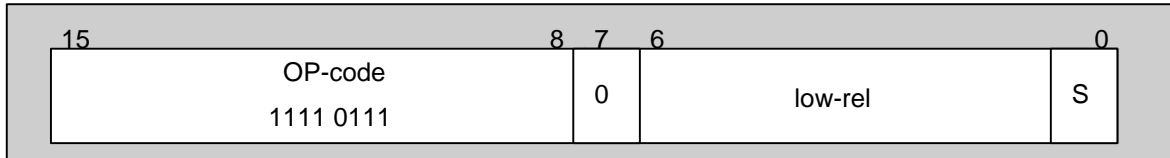

S: sign bit of rel

rel = 25 S // low-rel // 0

range -128 ~ 126

Notation:

BHE rel

Description:

If the carry flag C and the zero flag Z are cleared ($C = 0$ and $Z = 0$), place the branch address $PC + rel$ (relative of the first byte after the Branch instruction) in the program counter PC and clear the cache-mode flag M; all condition flags remain unchanged. Then instruction execution proceeds at the branch address placed in the PC

When the branch condition is not met, the M flag and the condition flags remain unchanged and instruction execution proceeds sequentially.

Note: rel is signed to allow forward or backward branches.

Operation:

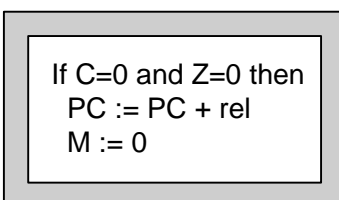

Exceptions:

None.

Branch on Less or Equal**BLE**

Format:

PCrel format

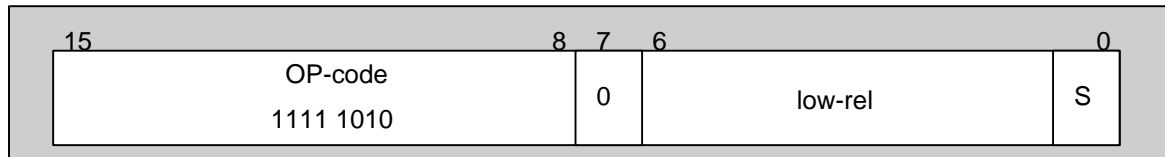

S: sign bit of rel

rel = 25 S // low-rel // 0

range -128 ~ 126

Notation:

BLE rel

Description:

If the negative flag N is set or the zero flag Z is set ($N = 1$ or $Z = 1$), place the branch address $PC + rel$ (relative of the first byte after the Branch instruction) in the program counter PC and clear the cache-mode flag M; all condition flags remain unchanged. Then instruction execution proceeds at the branch address placed in the PC

When the branch condition is not met, the M flag and the condition flags remain unchanged and instruction execution proceeds sequentially.

Note: rel is signed to allow forward or backward branches.

Operation:

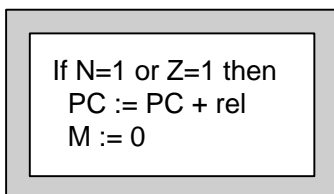

Exceptions:

None.

Branch on Less Than**BLT**

Format:

PCrel format

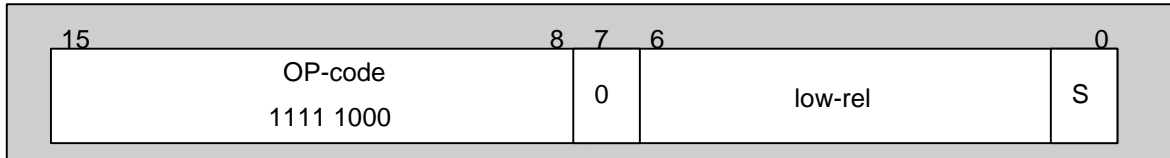

S: sign bit of rel

rel = 25 S // low-rel // 0

range -128 ~ 126

Notation:

BLT rel

Description:

If the negative flag N is set ($N = 1$), place the branch address $PC + rel$ (relative of the first byte after the Branch instruction) in the program counter PC and clear the cache-mode flag M; all condition flags remain unchanged. Then instruction execution proceeds at the branch address placed in the PC

When the branch condition is not met, the M flag and the condition flags remain unchanged and instruction execution proceeds sequentially.

Note: rel is signed to allow forward or backward branches.

Operation:

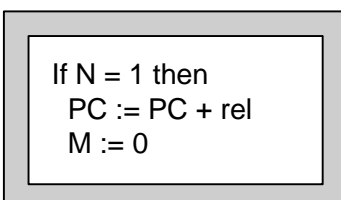

Exceptions:

None.

Branch on Negative**BN**

Format:

PCrel format

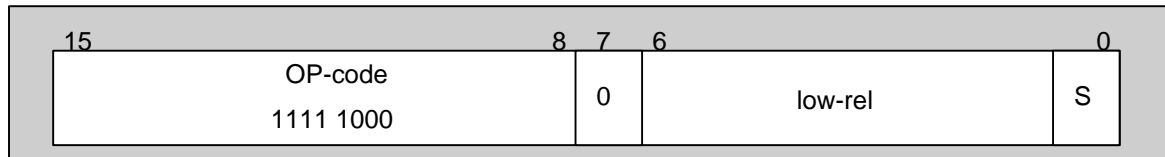

S: sign bit of rel

rel = 25 S // low-rel // 0

range -128 ~ 126

Notation:

BN rel

Description:

If the negative flag N is set ($N = 1$), place the branch address $PC + rel$ (relative of the first byte after the Branch instruction) in the program counter PC and clear the cache-mode flag M; all condition flags remain unchanged. Then instruction execution proceeds at the branch address placed in the PC

When the branch condition is not met, the M flag and the condition flags remain unchanged and instruction execution proceeds sequentially.

Note: rel is signed to allow forward or backward branches.

Operation:

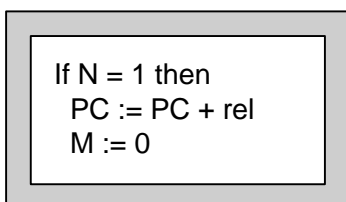

Exceptions:

None.

Branch on No Carry**BNC**

Format:

PCrel format

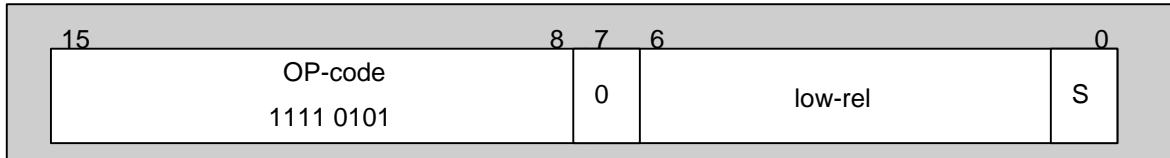

S: sign bit of rel

rel = 25 S // low-rel // 0

range -128 ~ 126

Notation:

BNC rel

Description:

If the carry flag **C** is cleared ($C = 0$), place the branch address $PC + rel$ (relative of the first byte after the Branch instruction) in the program counter **PC** and clear the cache-mode flag **M**; all condition flags remain unchanged. Then instruction execution proceeds at the branch address placed in the **PC**

When the branch condition is not met, the **M** flag and the condition flags remain unchanged and instruction execution proceeds sequentially.

Note: rel is signed to allow forward or backward branches.

Operation:

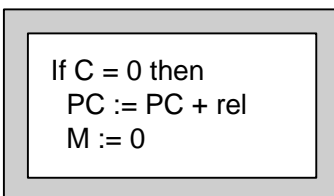

Exceptions:

None.

Branch on Not Equal**BNE**

Format:

PCrel format

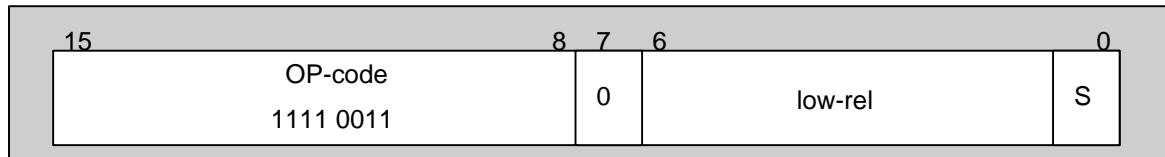

S: sign bit of rel

rel = 25 S // low-rel // 0

range -128 ~ 126

Notation:

BNE rel

Description:

If the zero flag Z is cleared ($Z = 0$), place the branch address $PC + rel$ (relative of the first byte after the Branch instruction) in the program counter PC and clear the cache-mode flag M ; all condition flags remain unchanged. Then instruction execution proceeds at the branch address placed in the PC

When the branch condition is not met, the M flag and the condition flags remain unchanged and instruction execution proceeds sequentially.

Note: rel is signed to allow forward or backward branches.

Operation:

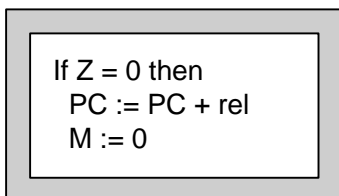

Exceptions:

None.

Branch on Non-Negative**BNN**

Format:

PCrel format

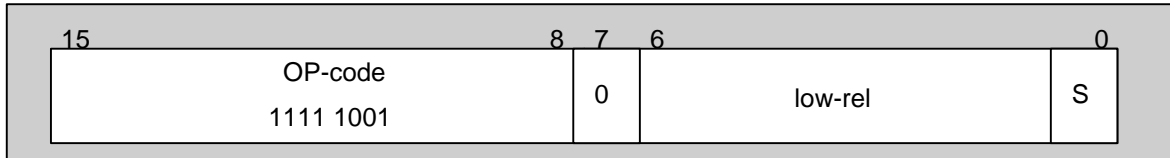

S: sign bit of rel

rel = 25 S // low-rel // 0

range -128 ~ 126

Notation:

BNN rel

Description:

If the negative flag N is cleared ($N = 0$, non-negative), place the branch address $PC + rel$ (relative of the first byte after the Branch instruction) in the program counter PC and clear the cache-mode flag M; all condition flags remain unchanged. Then instruction execution proceeds at the branch address placed in the PC

When the branch condition is not met, the M flag and the condition flags remain unchanged and instruction execution proceeds sequentially.

Note: rel is signed to allow forward or backward branches.

Operation:

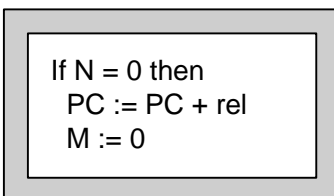

Exceptions:

None.

Branch on Not Overflow**BNV**

Format:

PCrel format

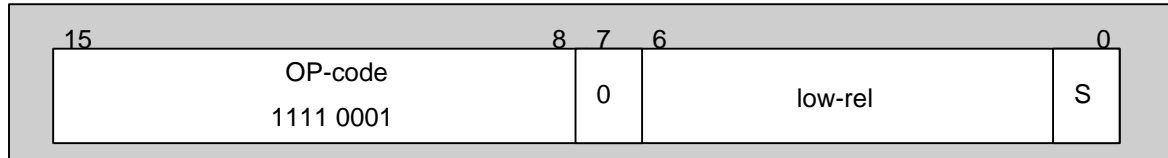

S: sign bit of rel

rel = 25 S // low-rel // 0

range -128 ~ 126

Notation:

BNV rel

Description:

If the overflow flag V is cleared ($V = 0$), place the branch address $PC + rel$ (relative of the first byte after the Branch instruction) in the program counter PC and clear the cache-mode flag M; all condition flags remain unchanged. Then instruction execution proceeds at the branch address placed in the PC

When the branch condition is not met, the M flag and the condition flags remain unchanged and instruction execution proceeds sequentially.

Note: rel is signed to allow forward or backward branches.

Operation:

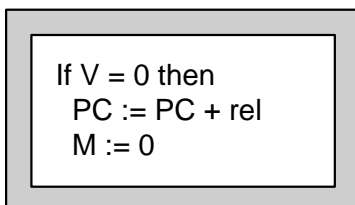

Exceptions:

None.

Branch on None-Zero**BNZ**

Format:

PCrel format

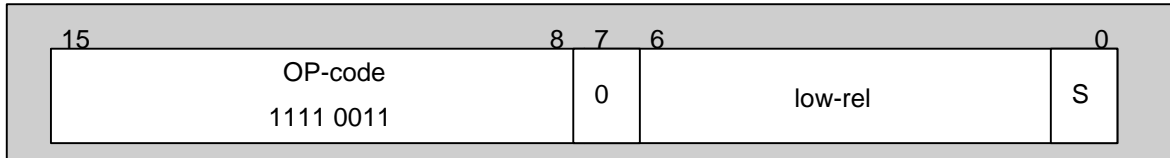

S: sign bit of rel

rel = 25 S // low-rel // 0

range -128 ~ 126

Notation:

BNZ rel

Description:

If the zero flag Z is cleared ($Z = 0$), place the branch address $PC + rel$ (relative of the first byte after the Branch instruction) in the program counter PC and clear the cache-mode flag M; all condition flags remain unchanged. Then instruction execution proceeds at the branch address placed in the PC

When the branch condition is not met, the M flag and the condition flags remain unchanged and instruction execution proceeds sequentially.

Note: rel is signed to allow forward or backward branches.

Operation:

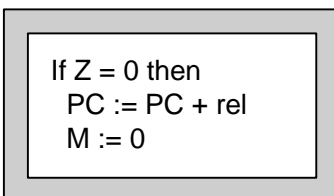

Exceptions:

None.

Branch on Smaller or Equal**BSE**

Format:

PCrel format

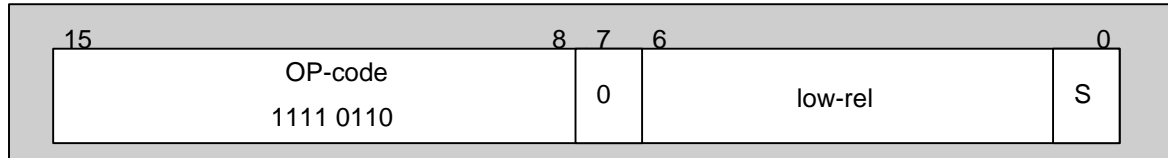

S: sign bit of rel

rel = 25 S // low-rel // 0

range -128 ~ 126

Notation:

BSE rel

Description:

If the carry flag C is set ($C = 1$) or the zero flag is set ($Z = 1$), place the branch address $PC + rel$ (relative of the first byte after the Branch instruction) in the program counter PC and clear the cache-mode flag M; all condition flags remain unchanged. Then instruction execution proceeds at the branch address placed in the PC

When the branch condition is not met, the M flag and the condition flags remain unchanged and instruction execution proceeds sequentially.

Note: rel is signed to allow forward or backward branches.

Operation:

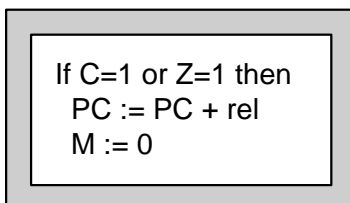

Exceptions:

None.

Branch**BR**

Format:

PCrel format

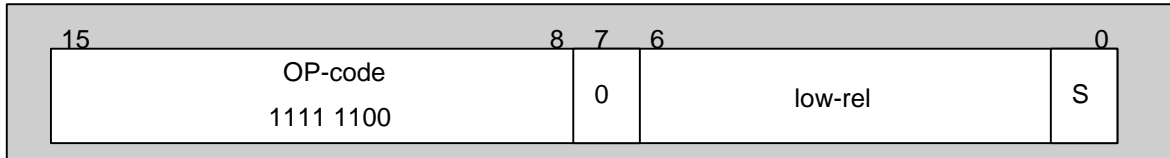

S: sign bit of rel

rel = 25 S // low-rel // 0

range -128 ~ 126

Notation:

BR rel

Description:

Place the branch address $PC + rel$ (relative of the first byte after the Branch instruction) in the program counter PC and clear the cache-mode flag M; all condition flags remain unchanged. Then instruction execution proceeds at the branch address placed in the PC

Note: rel is signed to allow forward or backward branches.

Operation:

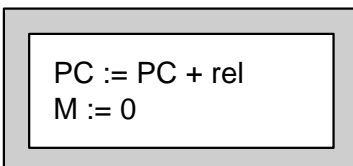

Exceptions:

None.

Branch on Overflow**BV**

Format:

PCrel format

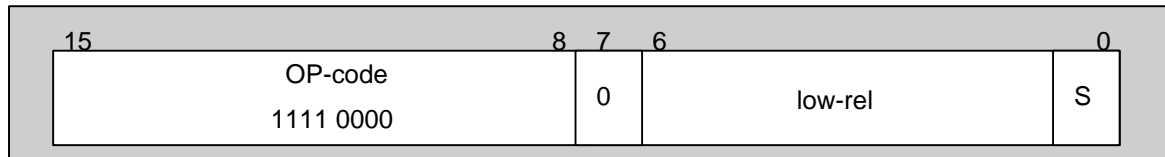

S: sign bit of rel

rel = 25 S // low-rel // 0

range -128 ~ 126

Notation:

BV rel

Description:

If the overflow flag V is set ($V = 1$), place the branch address $PC + rel$ (relative of the first byte after the Branch instruction) in the program counter PC and clear the cache-mode flag M; all condition flags remain unchanged. Then instruction execution proceeds at the branch address placed in the PC

When the branch condition is not met, the M flag and the condition flags remain unchanged and instruction execution proceeds sequentially.

Note: rel is signed to allow forward or backward branches.

Operation:

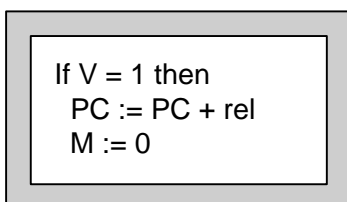

Exceptions:

None.

Branch on Zero**BZ**

Format:

PCrel format

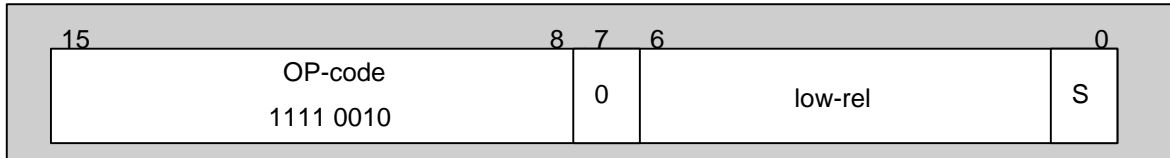

S: sign bit of rel

rel = 25 S // low-rel // 0

range -128 ~ 126

Notation:

BZ rel

Description:

If the zero flag is set ($Z = 1$), place the branch address $PC + rel$ (relative of the first byte after the Branch instruction) in the program counter PC and clear the cache-mode flag M; all condition flags remain unchanged. Then instruction execution proceeds at the branch address placed in the PC

When the branch condition is not met, the M flag and the condition flags remain unchanged and instruction execution proceeds sequentially.

Note: rel is signed to allow forward or backward branches.

Operation:

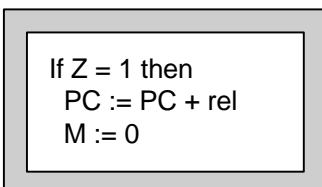

Exceptions:

None.

Call**CALL**

Format:

LRconst format

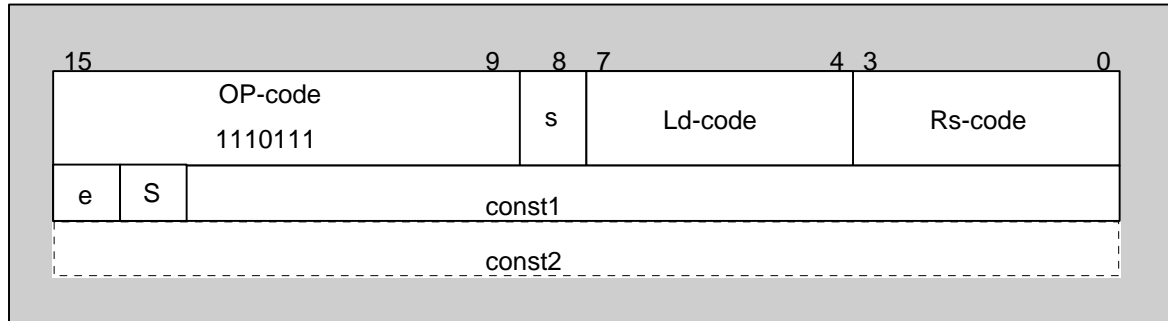

s = 0: Rs-code encoded G0..G15 for Rs

s = 1: Rs-code encoded L0..L15 for Rs, Ld-code encodes L0..L15 for Ld

S: Sign bit of const

e = 0: const = 18S // const1, range -16,384 ~ 16,383

e = 1: const = 2S // const1 // const2, range -1,073,741,824 ~ 1,073,741,823

Notation:

CALL Ld, Rs, const

CALL Ld, 0, const (when Rs denotes SR)

Description:

The Call instruction causes a branch to a subprogram.

The branch address $R_s + \text{const}$, or const alone if R_s denotes the SR, is placed in the program counter PC. The old PC containing the return address is saved in Ld; the old supervisor-state flag S is also saved in bit zero of Ld. The old status register SR is saved in Ldf, the saved instruction-length code ILC contains the length (2 or 3) of the Call instruction. Then the frame pointer FP is incremented by the value of the Ld-code and the frame length FL is set to six, thus creating a new stack frame.

The cache-mode flag M is cleared. All condition flags remain unchanged. Then instruction execution proceeds at the branch address placed in the PC.

Operation:

```

If Rs denotes not SR then PC := Rs +const
else PC := const
Ld := old PC(31..1) // old S;
Ldf := old SR;
FP := Fo + Ld code; (Ld-cod 0 is treated as 16)
FL := 6; M:= 0;

```

Exceptions:

None.

Check**CHK**

Format:

RR format

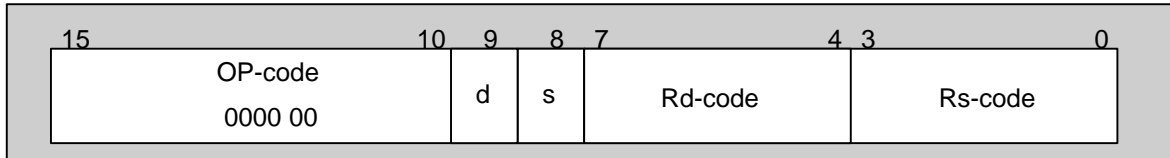

s = 0: Rs-code encoded G0..G15 for Rs
s = 1: Rs-code encoded L0..L15 for Rs
d = 0: Rd-code encoded G0..G15 for Rd
d = 1: Rd-code encoded L0..L15 for Rd

Notation:

CHK Rd, Rs

Description:

A destination operand is checked and a trap to a Range Error occurs if the destination operand is higher than the source operand.

All registers and all condition flags remain unchanged. All operands are interpreted as unsigned integers.

When Rs denotes the PC, CHK trap if $Rd \geq PC$. Thus, CHK PC, PC always traps. Since CHK PC, PC is encoded as 16 zeros, an erroneous jump into a string of zeros causes a trap to Range Error, thus trapping some address errors.

Operation:

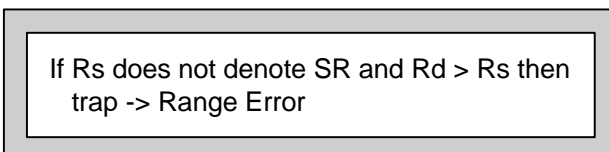

Exceptions:

Range Error.

Check Zero**CHKZ**

Format:

RR format

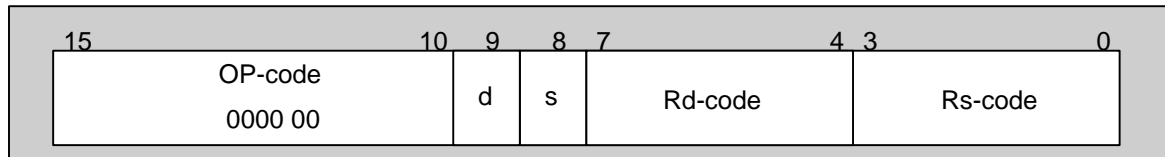

s = 0: Rs-code encoded G0..G15 for Rs

s = 1: Rs-code encoded L0..L15 for Rs

d = 0: Rd-code encoded G0..G15 for Rd

d = 1: Rd-code encoded L0..L15 for Rd

Notation:

CHK Rd, 0

Description:

A destination operand is checked and a trap to a Range Error occurs if the destination operand is zero.

All registers and all condition flags remain unchanged. All operands are interpreted as unsigned integers.

CHKZ shares its basic OP-code with CHK, it is differentiated by denoting the SR as source operand.

CHKZ may be used to trap on uninitialized pointers with the value zero.

Operation:

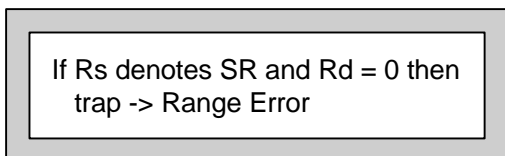

Exceptions:

Range Error.

Compare with Source Operand**CMP**

Format:

RR format

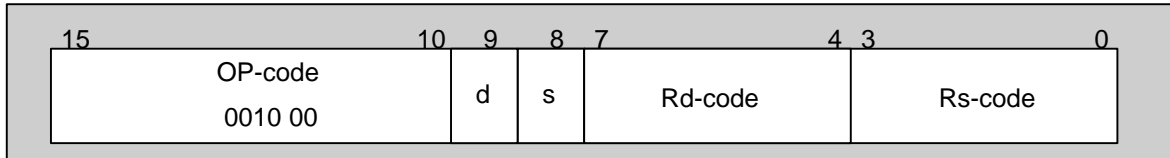

s = 0: Rs-code encoded G0..G15 for Rs
s = 1: Rs-code encoded L0..L15 for Rs
d = 0: Rd-code encoded G0..G15 for Rd
d = 1: Rd-code encoded L0..L15 for Rd

Notation:

CMP Rd, Rs

CMP Rd, C (when Rs denotes SR)

Description:

Two operands are compared by subtracting the source operand from the destination operand. The condition flags are set or cleared according to the result; the result itself is not retained. Note that the N flag indicates the correct compare result even in the case of an overflow.

All operands and the result are interpreted as either all signed or all unsigned integers.

When the SR is denoted as a source operand at CMP, C is subtracted instead of SR.

Operation:

<p>When Rs is not SR</p> <p>result := Rd - Rs; Z := Rd = Rs; N := Rd < Rs signed; V := overflow; C := Rd < RS unsigned;</p>	<p>When Rs is SR</p> <p>result := Rd - C; Z := Rd = C; N := Rd < C signed; V := overflow; C := Rd < C unsigned;</p>
---	---

Exceptions:

None

Compare Bit**CMPB**

Format:

RR format

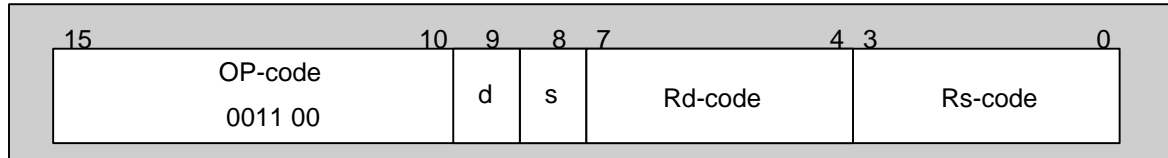

s = 0: Rs-code encoded G0..G15 for Rs

s = 1: Rs-code encoded L0..L15 for Rs

d = 0: Rd-code encoded G0..G15 for Rd

d = 1: Rd-code encoded L0..L15 for Rd

Notation:

CMPB Rd, Rs

Description:

The result of a bitwise logical AND of the source operand and the destination operand is used to set or clear the Z flag accordingly; the result itself is not retained.

All operands and the result are interpreted as bit-string of 32 bits each.

Operation:

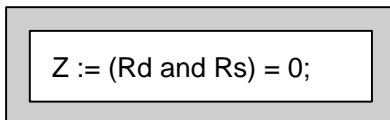

Exceptions:

None

Compare Bit with Immediate**CMPBI**

Format:

Rimm format

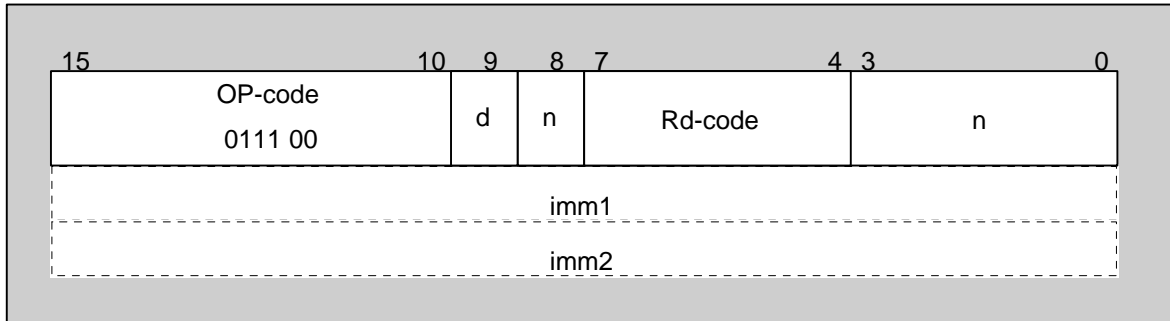

d = 0: Rd-code encoded G0..G15 for Rd

d = 1: Rd-code encoded L0..L15 for Rd

n: bit 8 // bit 3..0 encode n = 0..31, see Table 2.3 Encoding of Immediate Values

Notation:

CMPBI Rd, imm

CMPBI Rd, ANYBZ (when n = 0)

Description:

The result of a bitwise logical AND of the immediate operand and the destination operand is used to set or clear the Z flag accordingly; the result itself is not retained.

All operands and the result are interpreted as bit-string of 32 bits each.

A special case of CMPBI differentiated by n = 0, if any byte of the destination operand is zero then the zero flag Z is set (Z = 1).

Operation:

```

If n is not zero then
  Z := (Rd and imm);
else
  Z := Rd(31..24) = 0 or Rd(23..16) = 0 or
      Rd(15..8) = 0 or Rd(7..0) = 0

```

Exceptions:

None

Compare with Immediate

CMPI

Format:

Rimm format

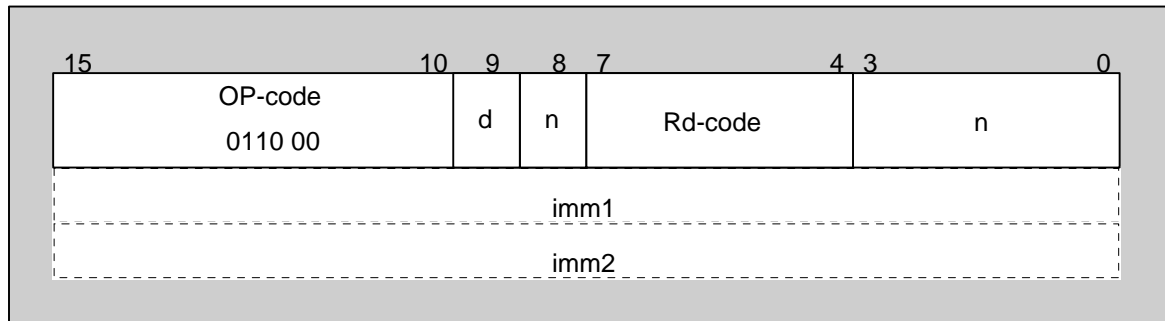

d = 0: Rd-code encoded G0..G15 for Rd

d = 1: Rd-code encoded L0..L15 for Rd

n: bit 8 // bit 3..0 encode n = 0..31, see Table 2.3 Encoding of Immediate Values

Notation:

CMPI Rd, imm

Description:

Two operands are compared by subtracting the source operand from the destination operand. The condition flags are set or cleared according to the result; the result itself is not retained. Note that the N flag indicates the correct compare result even in the case of an overflow.

All operands and the result are interpreted as either all signed or all unsigned integers.

Operation:

```

result := Rd - imm;
Z := Rd = imm;
N := Rd < imm signed;
V := overflow;
C := Rd < imm unsigned;

```

Exceptions:

None

Divide with Non-Negative Signed**DIVS**

Format:

RR format

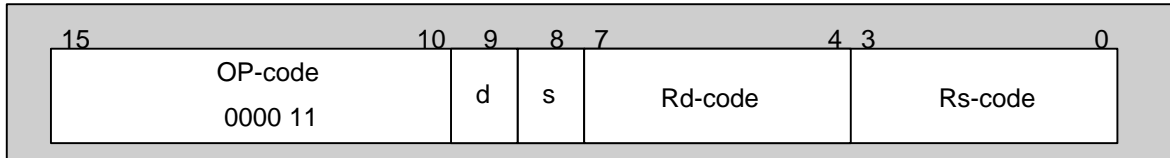

s = 0: Rs-code encoded G0..G15 for Rs
 s = 1: Rs-code encoded L0..L15 for Rs
 d = 0: Rd-code encoded G0..G15 for Rd
 d = 1: Rd-code encoded L0..L15 for Rd

Notation:

DIVS Rd, Rs

Description:

The double-word destination operand (dividend) is divided by the single-word source operand (divisor), the quotient is placed in the low-order destination register (Rdf), the remainder is placed in the high-order destination register (Rd) and the condition flags are set or cleared according to the quotient.

A trap to Range Error occurs if the divisor is zero or the value of the quotient exceeds the integer value range (quotient overflow). The result (in Rd//Rdf) is then undefined. A trap to Range Error also occurs and the result is undefined if the dividend is negative.

The dividend is a non-negative signed double-word integer, the divisor, the quotient and the remainder are signed integers; a non-zero remainder has the sign of the dividend.

The result is undefined if Rs denotes the same register as Rd or Rdf or if the PC or the SR is denoted.

Operation:

```

If Rs = 0 or quotient overflow or Rd(31) = 1 then
  Rd//Rdf := undefined;
  Z := undefined; N := undefined;
  V := 1 trap -> Range Error
else
  remainder Rd, quotient Rdf := (Rd//Rdf) / Rs;
  Z := Rdf = 0
  N := Rd(31), V := 0;

```

Exceptions:

Quotient Overflow (Trap to a Range Error)

Division by Zero (Trap to a Range Error)

Dividend is Negative (Trap to a Range Error)

Divide with Unsigned

DIVU

Format:

RR format

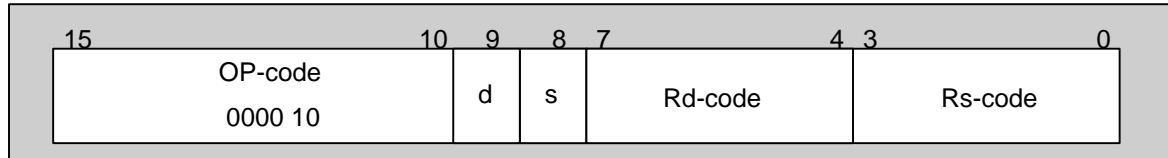

s = 0: Rs-code encoded G0..G15 for Rs

s = 1: Rs-code encoded L0..L15 for Rs

d = 0: Rd-code encoded G0..G15 for Rd

d = 1: Rd-code encoded L0..L15 for Rd

Notation:

DIVU Rd, Rs

Description:

The double-word destination operand (dividend) is divided by the single-word source operand (divisor), the quotient is placed in the low-order destination register (Rdf), the remainder is placed in the high-order destination register (Rd) and the condition flags are set or cleared according to the quotient.

A trap to Range Error occurs if the divisor is zero or the value of the quotient exceeds the integer value range (quotient overflow). The result (in Rd//Rdf) is then undefined.

The dividend is an unsigned double-word integer, the divisor, the quotient and the remainder are unsigned integers

The result is undefined if Rs denotes the same register as Rd or Rdf or if the PC or the SR is denoted.

Operation:

```

If Rs = 0 or quotient overflow then
  Rd//Rdf := undefined;
  Z := undefined;, N := undefined;,
  V :=1 trap -> Range Error
else
  remainder Rd, quotient Rdf := (Rd//Rdf) / Rs;
  Z := Rdf = 0
  N := Rd(31), V:= 0;

```

Exceptions:

Quotient Overflow (Trap to a Range Error)

Division by Zero (Trap to a Range Error)

Do**DO**

Format:

LL format

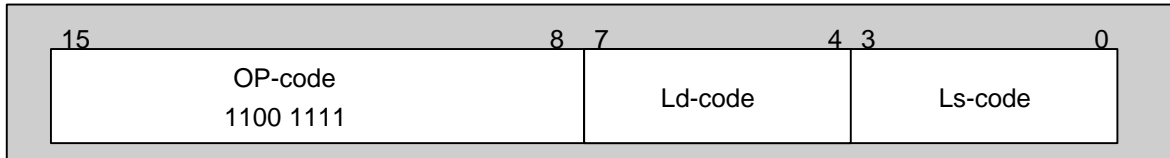

Ls-code encoded L0..L15 for Ls
 Ld-code encoded L0..L15 for Ld

Notation:

Do xx... Ld, Ls

Description:

The Do instruction is executed as a Software instruction. (The Software instructions causes a branch to the subprogram associated with each Software instruction.) The associated subprogram is entered, the stack address other destination operand and one double-word source operand are passed to it.

The halfword succeeding the Do instruction will be used by the associated subprogram to differentiate branches to subordinate routines; the associated subprogram must increment the saved return program counter PC by two.

“xx...” stands for the mnemonic of the differentiating halfword after the OP-code of the Do instruction.

Operation:

```

PC := 23 ones // 0 // OP(11..8) // 4 zeros;
(FP + FL)^ := stack address of Ld;
(FP + FL + 1)^ := Ls;
(FP + FL + 2)^ := Lsf;
(FP + FL + 3)^ := old PC(31..1) // old S;
(FP + FL + 4)^ := old SR;
FP := FP + FL, FL := 6;, M := 0;
T := 0; L := 1;
  
```

Exceptions:

None

Halfword (complex) add/sub with fixed-point adjustment **EHCFFTD**

Format:

LLext format

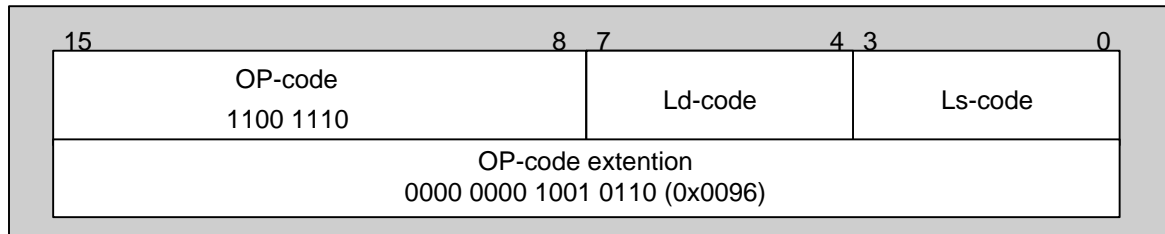

Ls-code encoded L0..L15 for Ls

Ld-code encoded L0..L15 for Ld

Notation:

EHCFFTD Ld, Ls

Description:

The extended DSP instruction uses on-chip multiply-accumulate unit. An Extended DSP instruction is issued in one cycle; the processor starts execution of the next instruction before the Extended DSP instruction is finished.

Double-word results are always placed in G14 and G15. The condition flags remain unchanged

Ls does not used and should denote he same register.

This instruction can cause a n Extended Overflow exception when the Extended Overflow Exception flag is enabled (FCR(16) = 0). Note that this overflow occurs asynchronously to the execution of the Extended DSP instruction and any succeeding instructions.

Operation:

$G14(31..16) := Ld(31..16) + (G14 \gg 15);$ $G14(15..0) := Ld(15..0) + (G15 \gg 15);$ $G15(31..16) := Ld(31..16) - (G14 \gg 15);$ $G15(15..0) := Ld(15..0) - (G15 \gg 15);$
--

Exceptions:

Extended Overflow Exception

Halfword complex multiply/add**EHCMACD**

Format:

LLeft format

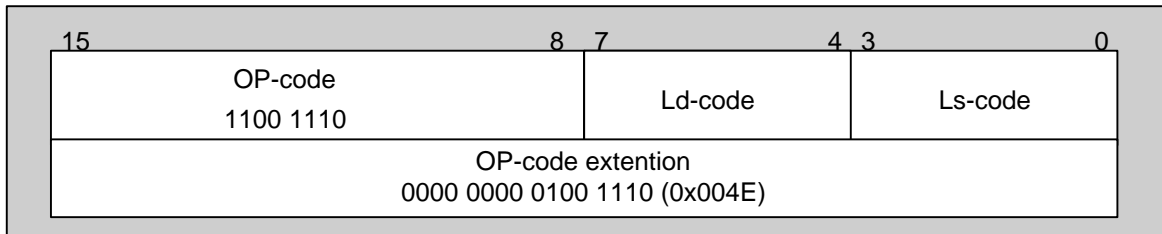

Ls-code encoded L0..L15 for Ls

Ld-code encoded L0..L15 for Ld

Notation:

EHCMACD Ld, Ls

Description:

The extended DSP instruction uses on-chip multiply-accumulate unit. An Extended DSP instruction is issued in one cycle; the processor starts execution of the next instruction before the Extended DSP instruction is finished.

Double-word results are always placed in G14 and G15. The condition flags remain unchanged

This instruction can cause a n Extended Overflow exception when the Extended Overflow Exception flag is enabled (FCR(16) = 0). Note that this overflow occurs asynchronously to the execution of the Extended DSP instruction and any succeeding instructions.

Operation:

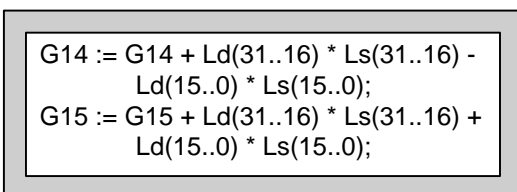

Exceptions:

Extended Overflow Exception

Halfword complex multiply**EHCMULD**

Format:

LLext format

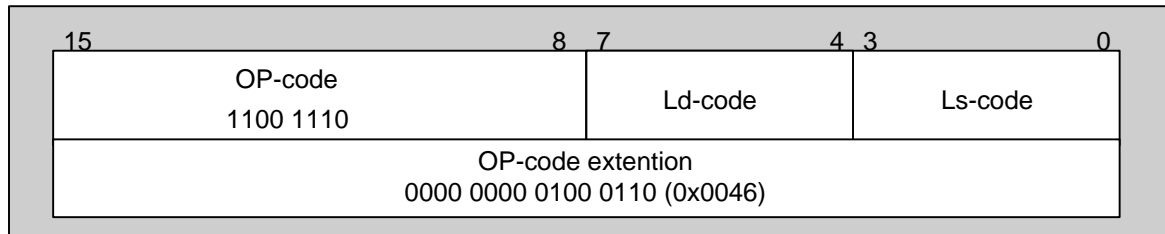

Ls-code encoded L0..L15 for Ls

Ld-code encoded L0..L15 for Ld

Notation:

EHCMULD Ld, Ls

Description:

The extended DSP instruction uses on-chip multiply-accumulate unit. An Extended DSP instruction is issued in one cycle; the processor starts execution of the next instruction before the Extended DSP instruction is finished.

Double-word results are always placed in G14 and G15. The condition flags remain unchanged

This instruction can cause a n Extended Overflow exception when the Extended Overflow Exception flag is enabled ($FCR(16) = 0$). Note that this overflow occurs asynchronously to the execution of the Extended DSP instruction and any succeeding instructions.

Operation:

$$G14 := Ld(31..16) * Ls(31..16) - Ld(15..0) * Ls(15..0);$$

$$G15 := Ld(31..16) * Ls(31..16) + Ld(15..0) * Ls(15..0);$$

Exceptions:

Extended Overflow Exception

Halfword (complex) add/subtract**EHCSUMD**

Format:

LLeft format

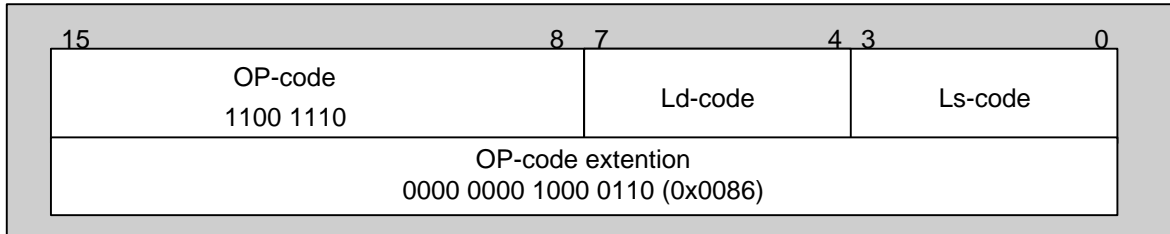

Ls-code encoded L0..L15 for Ls

Ld-code encoded L0..L15 for Ld

Notation:

EHCSUMD Ld, Ls

Description:

The extended DSP instruction uses on-chip multiply-accumulate unit. An Extended DSP instruction is issued in one cycle; the processor starts execution of the next instruction before the Extended DSP instruction is finished.

Double-word results are always placed in G14 and G15. The condition flags remain unchanged

This instruction can cause a n Extended Overflow exception when the Extended Overflow Exception flag is enabled ($FCR(16) = 0$). Note that this overflow occurs asynchronously to the execution of the Extended DSP instruction and any succeeding instructions.

Operation:

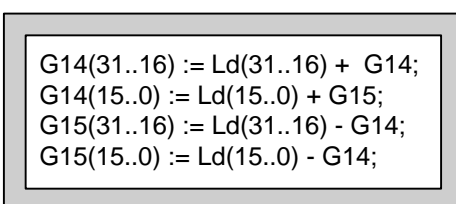

Exceptions:

Extended Overflow Exception

Signed halfword multiply/add, single word product sum **EHMAC**

Format:

LLext format

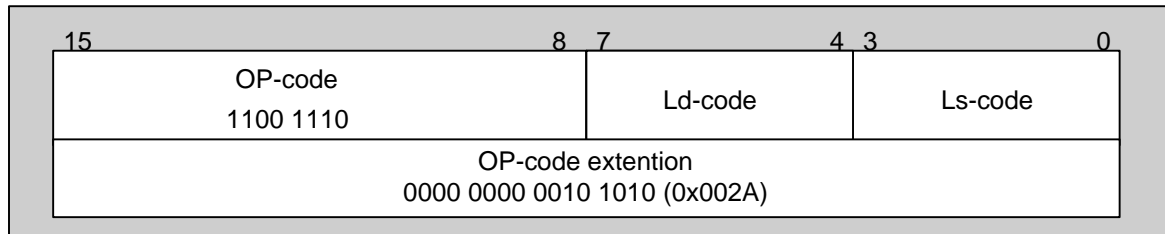

Ls-code encoded L0..L15 for Ls

Ld-code encoded L0..L15 for Ld

Notation:

EHMAC Ld, Ls

Description:

The extended DSP instruction uses on-chip multiply-accumulate unit. An Extended DSP instruction is issued in one cycle; the processor starts execution of the next instruction before the Extended DSP instruction is finished.

Single-word results always use register G15 as destination register. The condition flags remain unchanged

This instruction can cause a n Extended Overflow exception when the Extended Overflow Exception flag is enabled (FCR(16) = 0). Note that this overflow occurs asynchronously to the execution of the Extended DSP instruction and any succeeding instructions.

Operation:

$$G15 := G15 + Ld(31..16) * Ls(31..16) + Ld(15..0) * Ls(15..0);$$

Exceptions:

Extended Overflow Exception

Signed halfword multiply/add, double word product sum **EHMACD**

Format:

LLeft format

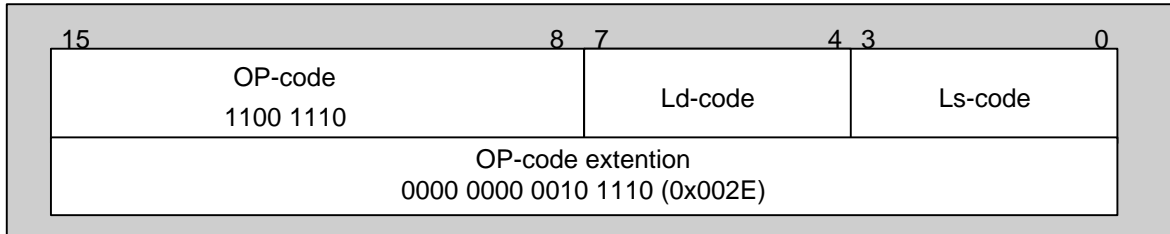

Ls-code encoded L0..L15 for Ls

Ld-code encoded L0..L15 for Ld

Notation:

EHMACD Ld, Ls

Description:

The extended DSP instruction uses on-chip multiply-accumulate unit. An Extended DSP instruction is issued in one cycle; the processor starts execution of the next instruction before the Extended DSP instruction is finished.

Double-word results are always placed in G14 and G15. The condition flags remain unchanged

This instruction can cause a n Extended Overflow exception when the Extended Overflow Exception flag is enabled ($FCR(16) = 0$). Note that this overflow occurs asynchronously to the execution of the Extended DSP instruction and any succeeding instructions.

Operation:

$$G14//G15 = G14//G15 + Ld(31..16) * Ls(31..16) + Ld(15..0) * Ls(15..0);$$

Exceptions:

Extended Overflow Exception

Signed multiply/add, single word product sum**EMAC**

Format:

LLext format

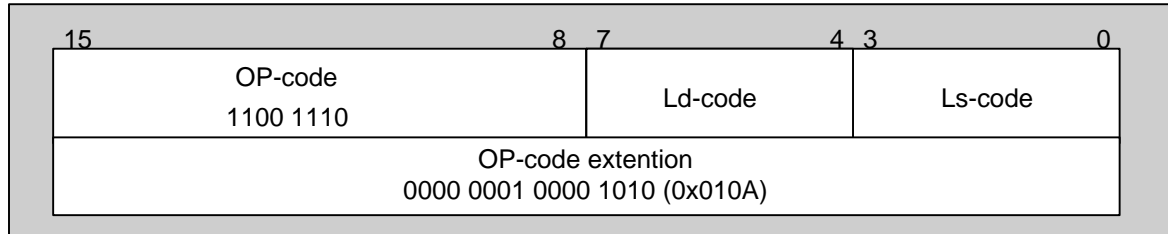

Ls-code encoded L0..L15 for Ls
Ld-code encoded L0..L15 for Ld

Notation:

EMAC Ld, Ls

Description:

The extended DSP instruction uses on-chip multiply-accumulate unit. An Extended DSP instruction is issued in one cycle; the processor starts execution of the next instruction before the Extended DSP instruction is finished.

Single-word results always use register G15 as destination register. The condition flags remain unchanged

This instruction can cause a n Extended Overflow exception when the Extended Overflow Exception flag is enabled (FCR(16) = 0). Note that this overflow occurs asynchronously to the execution of the Extended DSP instruction and any succeeding instructions.

Operation:

$$G15 = G15 + Ld * Ls$$

Exceptions:

Extended Overflow Exception

Signed multiply/add, double word product sum**EMACD**

Format:

LLevt format

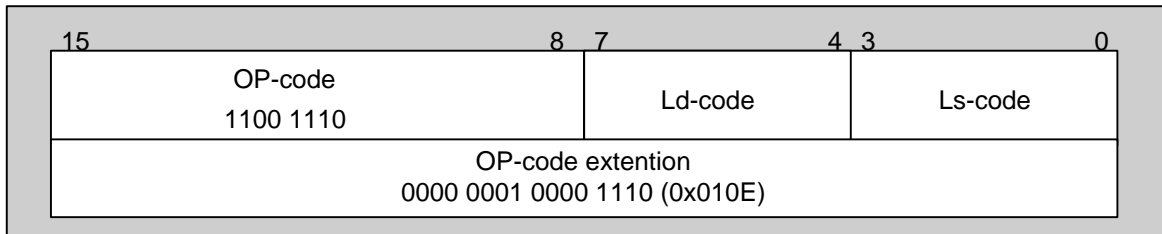

Ls-code encoded L0..L15 for Ls

Ld-code encoded L0..L15 for Ld

Notation:

EMACD Ld, Ls

Description:

The extended DSP instruction uses on-chip multiply-accumulate unit. An Extended DSP instruction is issued in one cycle; the processor starts execution of the next instruction before the Extended DSP instruction is finished.

Double-word results are always placed in G14 and G15. The condition flags remain unchanged

This instruction can cause a n Extended Overflow exception when the Extended Overflow Exception flag is enabled (FCR(16) = 0). Note that this overflow occurs asynchronously to the execution of the Extended DSP instruction and any succeeding instructions.

Operation:

$$G14//G15 = G14//G15 + Ld * Ls$$

Exceptions:

Extended Overflow Exception

Signed multiply/subtract, single word product difference**EMSUB**

Format:

LLext format

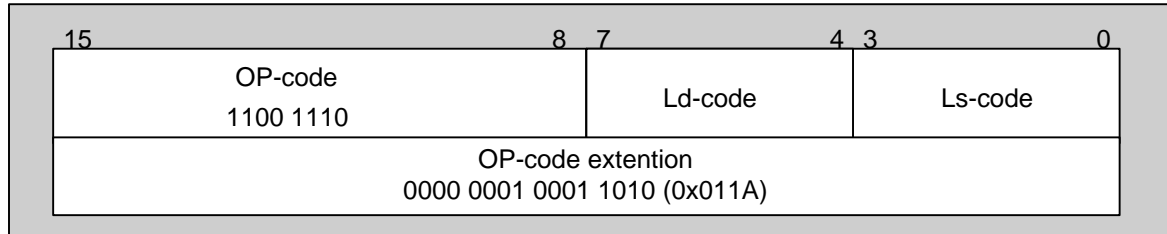

Ls-code encoded L0..L15 for Ls
Ld-code encoded L0..L15 for Ld

Notation:

EMSUB Ld, Ls

Description:

The extended DSP instruction uses on-chip multiply-accumulate unit. An Extended DSP instruction is issued in one cycle; the processor starts execution of the next instruction before the Extended DSP instruction is finished.

Single-word results always use register G15 as destination register. The condition flags remain unchanged

This instruction can cause a n Extended Overflow exception when the Extended Overflow Exception flag is enabled (FCR(16) = 0). Note that this overflow occurs asynchronously to the execution of the Extended DSP instruction and any succeeding instructions.

Operation:

$$G15 = G15 - Ld * Ls$$

Exceptions:

Extended Overflow Exception

Signed multiply/subtract, double word product difference **EMSUBD**

Format:

LLeft format

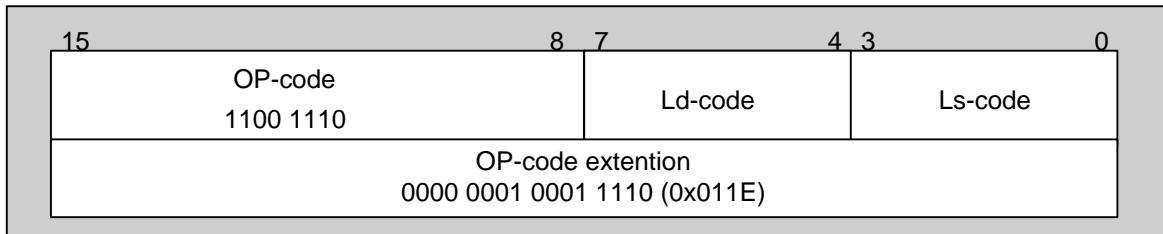

Ls-code encoded L0..L15 for Ls

Ld-code encoded L0..L15 for Ld

Notation:

EMSUBD Ld, Ls

Description:

The extended DSP instruction uses on-chip multiply-accumulate unit. An Extended DSP instruction is issued in one cycle; the processor starts execution of the next instruction before the Extended DSP instruction is finished.

Double-word results are always placed in G14 and G15. The condition flags remain unchanged

This instruction can cause a n Extended Overflow exception when the Extended Overflow Exception flag is enabled (FCR(16) = 0). Note that this overflow occurs asynchronously to the execution of the Extended DSP instruction and any succeeding instructions.

Operation:

$$G14//G15 = G14//G15 - Ld * Ls$$

Exceptions:

Extended Overflow Exception

Signed or unsigned multiplication, single word product**EMUL**

Format:

LLeft format

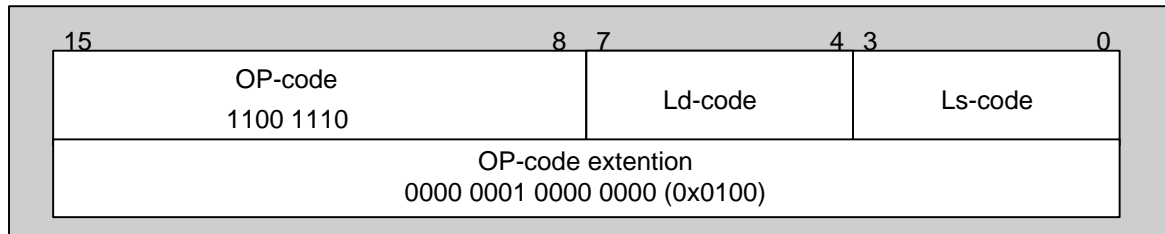

Ls-code encoded L0..L15 for Ls

Ld-code encoded L0..L15 for Ld

Notation:

EMUL Ld, Ls

Description:

The extended DSP instruction uses on-chip multiply-accumulate unit. An Extended DSP instruction is issued in one cycle; the processor starts execution of the next instruction before the Extended DSP instruction is finished.

Single-word results always use register G15 as destination register. The condition flags remain unchanged

Operation:

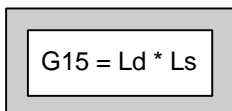

Exceptions:

None.

Signed multiplication, double word product**EMULS**

Format:

LLevt format

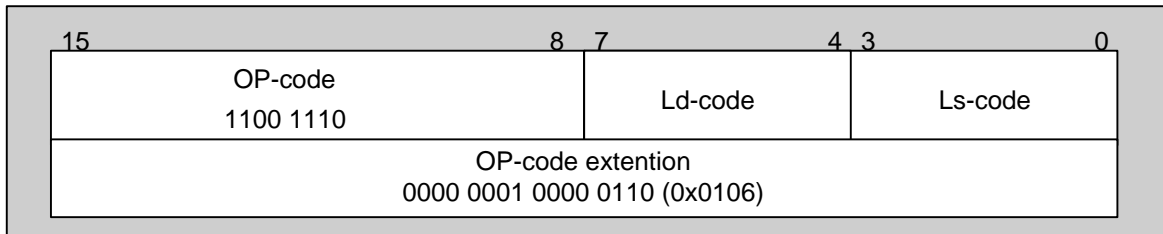

Ls-code encoded L0..L15 for Ls

Ld-code encoded L0..L15 for Ld

Notation:

EMULS Ld, Ls

Description:

The extended DSP instruction uses on-chip multiply-accumulate unit. An Extended DSP instruction is issued in one cycle; the processor starts execution of the next instruction before the Extended DSP instruction is finished.

Double-word results are always placed in G14 and G15. The condition flags remain unchanged

Operation:

$G14//G15 = Ld * Ls$

Exceptions:

None.

Unsigned multiplication, double word product**EMULU**

Format:

LLeft format

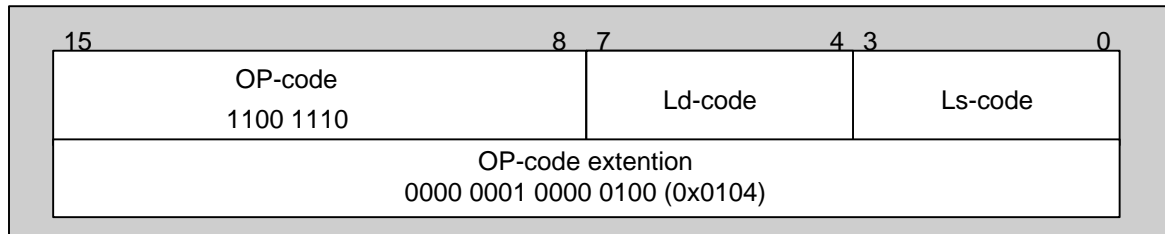

Ls-code encoded L0..L15 for Ls

Ld-code encoded L0..L15 for Ld

Notation:

EMULU Ld, Ls

Description:

The extended DSP instruction uses on-chip multiply-accumulate unit. An Extended DSP instruction is issued in one cycle; the processor starts execution of the next instruction before the Extended DSP instruction is finished.

Double-word results are always placed in G14 and G15. The condition flags remain unchanged

Operation:

$G14//G15 = Ld * Ls$

Exceptions:

None.

Delayed Branch on Carry**DBC**

Format:

PCrel format

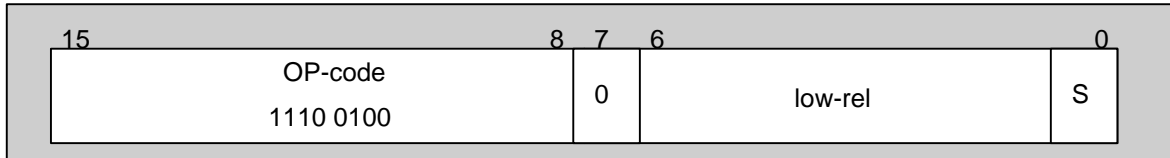

S: sign bit of rel

rel = 25 S // low-rel // 0

range -128 ~ 126

Notation:

DBC rel

Description:

If the carry flag C is set ($C = 1$), place the branch address $PC + rel$ (relative of the first byte after the Branch instruction) in the program counter PC. All condition flags and the cache mode flag M remain unchanged.

Then the instruction after the Delayed Branch instruction, called the delay instruction, is executed regardless of whether the delayed branch is taken or not taken.

When the delayed branch is not taken, the delay instruction is executed like a regular instruction. The PC and the ILC are updated accordingly and instruction execution proceeds sequentially.

When the delayed branch is taken, the delay instruction is executed before execution proceeds at the branch target. The PC (containing the delayed-branch target address) is not updated by the delay instruction. Any reference to the PC by the delay instruction references the delayed-branch target address.

Operation:

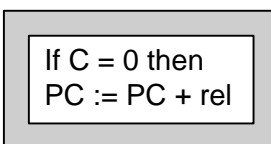

Exceptions:

None.

Delayed Branch on Equal

DBE

Format:

PCrel format

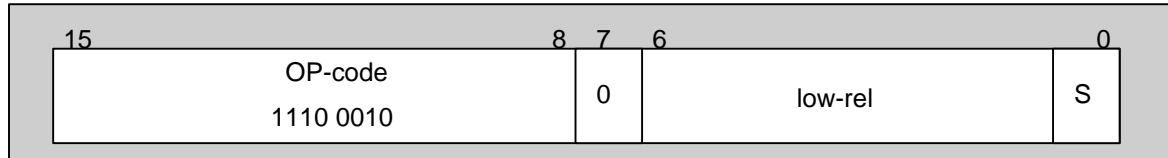

S: sign bit of rel

rel = 25 S // low-rel // 0

range -128 ~ 126

Notation:

DBE rel

Description:

If the zero flag is set ($Z = 1$), place the branch address $PC + rel$ (relative of the first byte after the Branch instruction) in the program counter PC. All condition flags and the cache mode flag M remain unchanged.

Then the instruction after the Delayed Branch instruction, called the delay instruction, is executed regardless of whether the delayed branch is taken or not taken.

When the delayed branch is not taken, the delay instruction is executed like a regular instruction. The PC and the ILC are updated accordingly and instruction execution proceeds sequentially.

When the delayed branch is taken, the delay instruction is executed before execution proceeds at the branch target. The PC (containing the delayed-branch target address) is not updated by the delay instruction. Any reference to the PC by the delay instruction references the delayed-branch target address.

Operation:

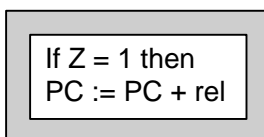

Exceptions:

None.

Delayed Branch on Greater or Equal**DBGE**

Format:

PCrel format

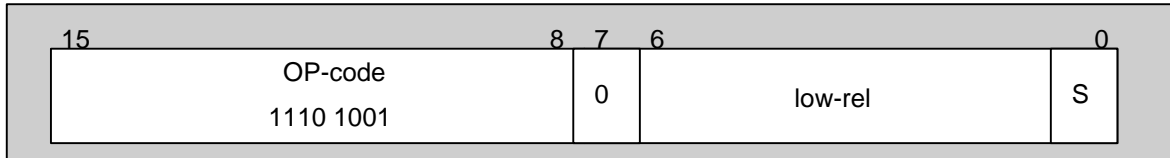

S: sign bit of rel

rel = 25 S // low-rel // 0

range -128 ~ 126

Notation:

DBGE rel

Description:

If the negative flag N is cleared (N = 0, non-negative), place the branch address PC + rel (relative of the first byte after the Branch instruction) in the program counter PC. All condition flags and the cache mode flag M remain unchanged.

Then the instruction after the Delayed Branch instruction, called the delay instruction, is executed regardless of whether the delayed branch is taken or not taken.

When the delayed branch is not taken, the delay instruction is executed like a regular instruction. The PC and the ILC are updated accordingly and instruction execution proceeds sequentially.

When the delayed branch is taken, the delay instruction is executed before execution proceeds at the branch target. The PC (containing the delayed-branch target address) is not updated by the delay instruction. Any reference to the PC by the delay instruction references the delayed-branch target address.

Operation:

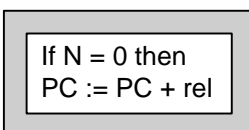

Exceptions:

None.

Delayed Branch on Greater Than

DBGT

Format:

PCrel format

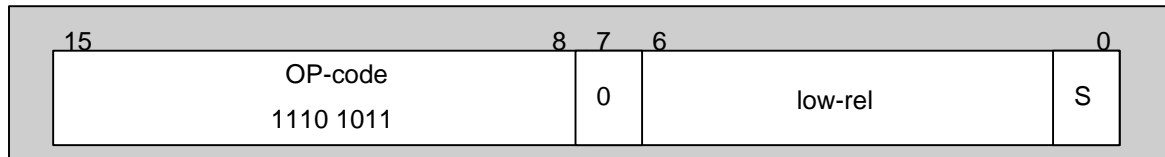

S: sign bit of rel

rel = 25 S // low-rel // 0

range -128 ~ 126

Notation:

DBGT rel

Description:

If the negative flag N and the zero flag Z are cleared (N = 0 and Z = 0), place the branch address PC + rel (relative of the first byte after the Branch instruction) in the program counter PC. All condition flags and the cache mode flag M remain unchanged.

Then the instruction after the Delayed Branch instruction, called the delay instruction, is executed regardless of whether the delayed branch is taken or not taken.

When the delayed branch is not taken, the delay instruction is executed like a regular instruction. The PC and the ILC are updated accordingly and instruction execution proceeds sequentially.

When the delayed branch is taken, the delay instruction is executed before execution proceeds at the branch target. The PC (containing the delayed-branch target address) is not updated by the delay instruction. Any reference to the PC by the delay instruction references the delayed-branch target address.

Operation:

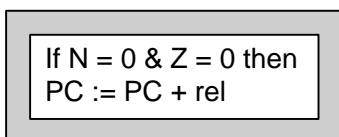

Exceptions:

None.

Delayed Branch on Higher or Equal

DBHE

Format:

PCrel format

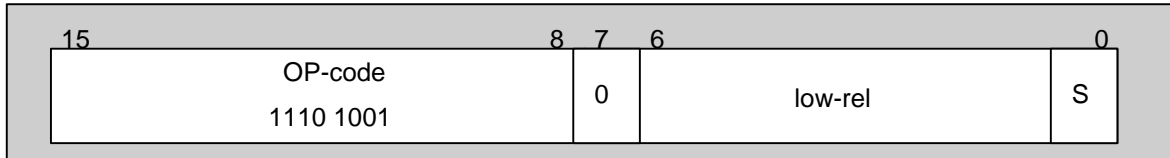

S: sign bit of rel

rel = 25 S // low-rel // 0

range -128 ~ 126

Notation:

DBHE rel

Description:

If the carry flag C is cleared ($C = 0$), place the branch address $PC + rel$ (relative of the first byte after the Branch instruction) in the program counter PC. All condition flags and the cache mode flag M remain unchanged.

Then the instruction after the Delayed Branch instruction, called the delay instruction, is executed regardless of whether the delayed branch is taken or not taken.

When the delayed branch is not taken, the delay instruction is executed like a regular instruction. The PC and the ILC are updated accordingly and instruction execution proceeds sequentially.

When the delayed branch is taken, the delay instruction is executed before execution proceeds at the branch target. The PC (containing the delayed-branch target address) is not updated by the delay instruction. Any reference to the PC by the delay instruction references the delayed-branch target address.

Operation:

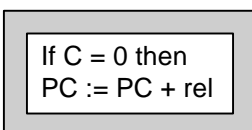

Exceptions:

None.

Delayed Branch on Higher Than

DBHT

Format:

PCrel format

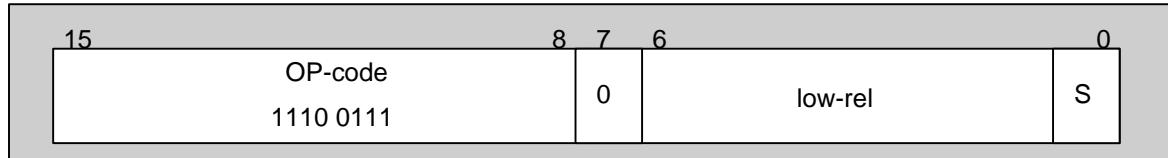

S: sign bit of rel

rel = 25 S // low-rel // 0

range -128 ~ 126

Notation:

DBHE rel

Description:

If the carry flag *C* and the zero flag *Z* are cleared ($C = 0$ and $Z = 0$), place the branch address $PC + rel$ (relative of the first byte after the Branch instruction) in the program counter *PC*. All condition flags and the cache mode flag *M* remain unchanged.

Then the instruction after the Delayed Branch instruction, called the delay instruction, is executed regardless of whether the delayed branch is taken or not taken.

When the delayed branch is not taken, the delay instruction is executed like a regular instruction. The *PC* and the *ILC* are updated accordingly and instruction execution proceeds sequentially.

When the delayed branch is taken, the delay instruction is executed before execution proceeds at the branch target. The *PC* (containing the delayed-branch target address) is not updated by the delay instruction. Any reference to the *PC* by the delay instruction references the delayed-branch target address.

Operation:

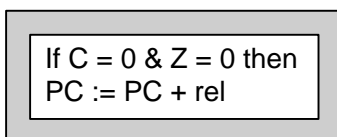

Exceptions:

None.

Delayed Branch on Less or Equal**DBLE**

Format:

PCrel format

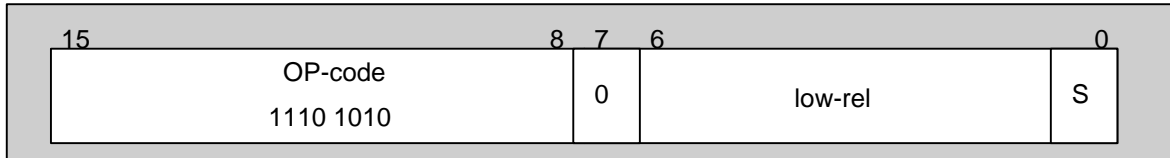

S: sign bit of rel

rel = 25 S // low-rel // 0

range -128 ~ 126

Notation:

DBLE rel

Description:

If the negative flag N is set or the zero flag Z is set ($N = 1$ or $Z = 1$), place the branch address $PC + rel$ (relative of the first byte after the Branch instruction) in the program counter PC. All condition flags and the cache mode flag M remain unchanged.

Then the instruction after the Delayed Branch instruction, called the delay instruction, is executed regardless of whether the delayed branch is taken or not taken.

When the delayed branch is not taken, the delay instruction is executed like a regular instruction. The PC and the ILC are updated accordingly and instruction execution proceeds sequentially.

When the delayed branch is taken, the delay instruction is executed before execution proceeds at the branch target. The PC (containing the delayed-branch target address) is not updated by the delay instruction. Any reference to the PC by the delay instruction references the delayed-branch target address.

Operation:

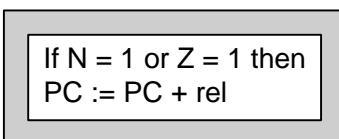

Exceptions:

None.

Delayed Branch on Less Than

DBLT

Format:

PCrel format

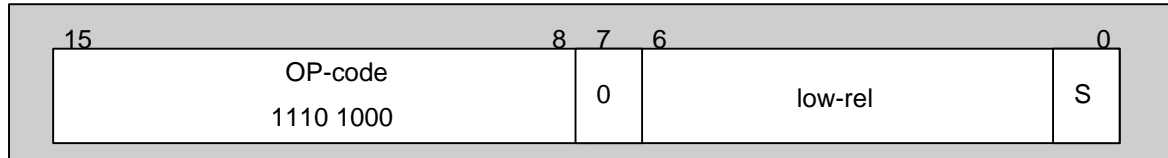

S: sign bit of rel

rel = 25 S // low-rel // 0

range -128 ~ 126

Notation:

DBLT rel

Description:

If the negative flag N is set ($N = 1$), place the branch address $PC + rel$ (relative of the first byte after the Branch instruction) in the program counter PC. All condition flags and the cache mode flag M remain unchanged.

Then the instruction after the Delayed Branch instruction, called the delay instruction, is executed regardless of whether the delayed branch is taken or not taken.

When the delayed branch is not taken, the delay instruction is executed like a regular instruction. The PC and the ILC are updated accordingly and instruction execution proceeds sequentially.

When the delayed branch is taken, the delay instruction is executed before execution proceeds at the branch target. The PC (containing the delayed-branch target address) is not updated by the delay instruction. Any reference to the PC by the delay instruction references the delayed-branch target address.

Operation:

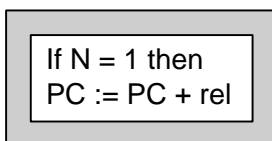

Exceptions:

None.

Delayed Branch on Negative

DBN

Format:

PCrel format

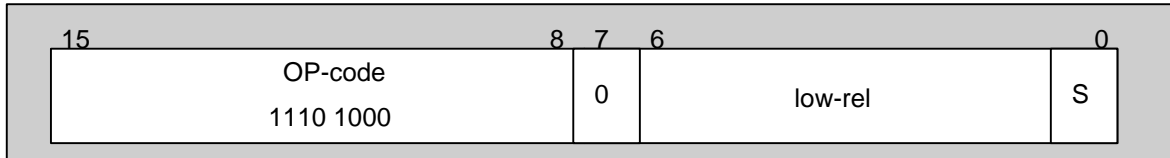

S: sign bit of rel

rel = 25 S // low-rel // 0

range -128 ~ 126

Notation:

DBN rel

Description:

If the negative flag N is set ($N = 1$), place the branch address $PC + rel$ (relative of the first byte after the Branch instruction) in the program counter PC. All condition flags and the cache mode flag M remain unchanged.

Then the instruction after the Delayed Branch instruction, called the delay instruction, is executed regardless of whether the delayed branch is taken or not taken.

When the delayed branch is not taken, the delay instruction is executed like a regular instruction. The PC and the ILC are updated accordingly and instruction execution proceeds sequentially.

When the delayed branch is taken, the delay instruction is executed before execution proceeds at the branch target. The PC (containing the delayed-branch target address) is not updated by the delay instruction. Any reference to the PC by the delay instruction references the delayed-branch target address.

Operation:

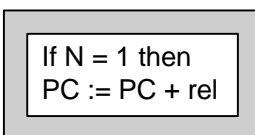

Exceptions:

None.

Delayed Branch on No Carry**DBNC**

Format:

PCrel format

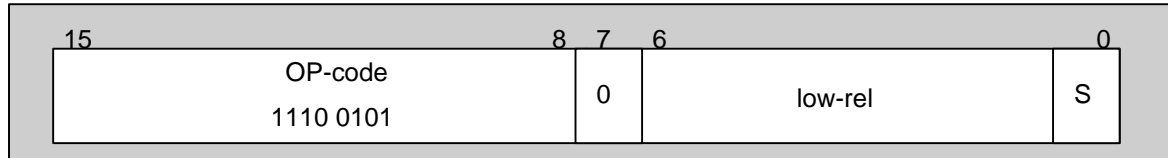

S: sign bit of rel

rel = 25 S // low-rel // 0

range -128 ~ 126

Notation:

DBNC rel

Description:

If the carry flag C is cleared ($C = 0$), place the branch address $PC + rel$ (relative of the first byte after the Branch instruction) in the program counter PC . All condition flags and the cache mode flag M remain unchanged.

Then the instruction after the Delayed Branch instruction, called the delay instruction, is executed regardless of whether the delayed branch is taken or not taken.

When the delayed branch is not taken, the delay instruction is executed like a regular instruction. The PC and the ILC are updated accordingly and instruction execution proceeds sequentially.

When the delayed branch is taken, the delay instruction is executed before execution proceeds at the branch target. The PC (containing the delayed-branch target address) is not updated by the delay instruction. Any reference to the PC by the delay instruction references the delayed-branch target address.

Operation:

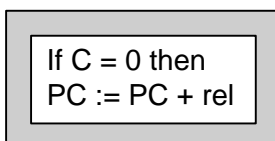

Exceptions:

None.

Delayed Branch on Not Equal**DBNE**

Format:

PCrel format

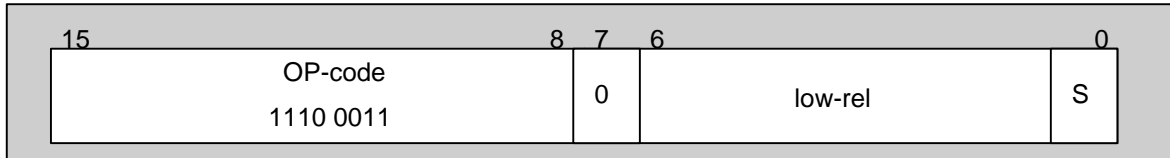

S: sign bit of rel

rel = 25 S // low-rel // 0

range -128 ~ 126

Notation:

DBNE rel

Description:

If the zero flag Z is cleared ($Z = 0$), place the branch address $PC + rel$ (relative of the first byte after the Branch instruction) in the program counter PC. All condition flags and the cache mode flag M remain unchanged.

Then the instruction after the Delayed Branch instruction, called the delay instruction, is executed regardless of whether the delayed branch is taken or not taken.

When the delayed branch is not taken, the delay instruction is executed like a regular instruction. The PC and the ILC are updated accordingly and instruction execution proceeds sequentially.

When the delayed branch is taken, the delay instruction is executed before execution proceeds at the branch target. The PC (containing the delayed-branch target address) is not updated by the delay instruction. Any reference to the PC by the delay instruction references the delayed-branch target address.

Operation:

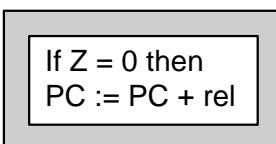

Exceptions:

None.

Delayed Branch on Non-Negative**DBNN**

Format:

PCrel format

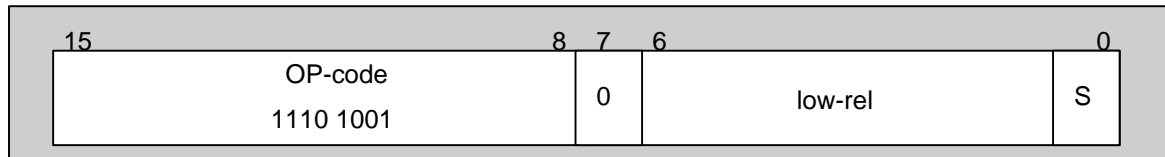

S: sign bit of rel

rel = 25 S // low-rel // 0

range -128 ~ 126

Notation:

DBNN rel

Description:

If the negative flag N is cleared (N = 0, non-negative), place the branch address PC + rel (relative of the first byte after the Branch instruction) in the program counter PC. All condition flags and the cache mode flag M remain unchanged.

Then the instruction after the Delayed Branch instruction, called the delay instruction, is executed regardless of whether the delayed branch is taken or not taken.

When the delayed branch is not taken, the delay instruction is executed like a regular instruction. The PC and the ILC are updated accordingly and instruction execution proceeds sequentially.

When the delayed branch is taken, the delay instruction is executed before execution proceeds at the branch target. The PC (containing the delayed-branch target address) is not updated by the delay instruction. Any reference to the PC by the delay instruction references the delayed-branch target address.

Operation:

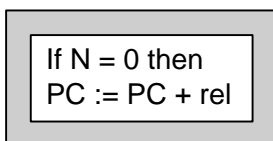

Exceptions:

None.

Delayed Branch on Not Overflow**DBNV**

Format:

PCrel format

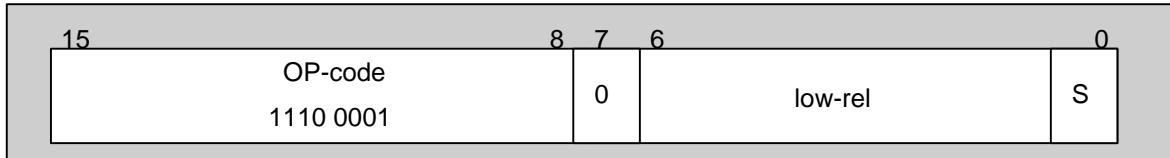

S: sign bit of rel

rel = 25 S // low-rel // 0

range -128 ~ 126

Notation:

DBNV rel

Description:

If the overflow flag V is cleared ($V = 0$), place the branch address $PC + rel$ (relative of the first byte after the Branch instruction) in the program counter PC . All condition flags and the cache mode flag M remain unchanged.

Then the instruction after the Delayed Branch instruction, called the delay instruction, is executed regardless of whether the delayed branch is taken or not taken.

When the delayed branch is not taken, the delay instruction is executed like a regular instruction. The PC and the ILC are updated accordingly and instruction execution proceeds sequentially.

When the delayed branch is taken, the delay instruction is executed before execution proceeds at the branch target. The PC (containing the delayed-branch target address) is not updated by the delay instruction. Any reference to the PC by the delay instruction references the delayed-branch target address.

Operation:

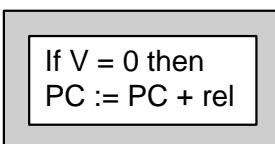

Exceptions:

None.

Delayed Branch on None-Zero**DBNZ**

Format:

PCrel format

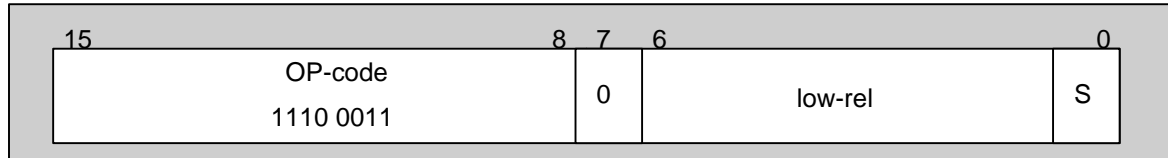

S: sign bit of rel

rel = 25 S // low-rel // 0

range -128 ~ 126

Notation:

DBNZ rel

Description:

If the zero flag Z is cleared ($Z = 0$), place the branch address $PC + rel$ (relative of the first byte after the Branch instruction) in the program counter PC. All condition flags and the cache mode flag M remain unchanged.

Then the instruction after the Delayed Branch instruction, called the delay instruction, is executed regardless of whether the delayed branch is taken or not taken.

When the delayed branch is not taken, the delay instruction is executed like a regular instruction. The PC and the ILC are updated accordingly and instruction execution proceeds sequentially.

When the delayed branch is taken, the delay instruction is executed before execution proceeds at the branch target. The PC (containing the delayed-branch target address) is not updated by the delay instruction. Any reference to the PC by the delay instruction references the delayed-branch target address.

Operation:

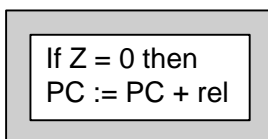

Exceptions:

None.

Delayed Branch on Smaller or Equal**DBSE**

Format:

PCrel format

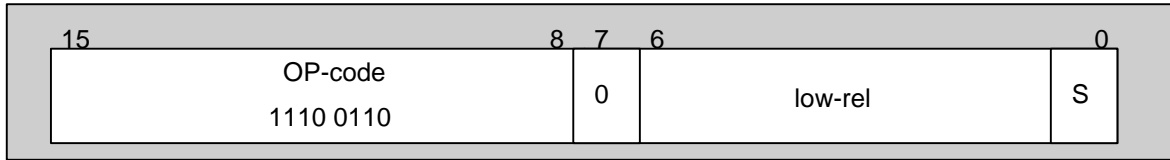

S: sign bit of rel

rel = 25 S // low-rel // 0

range -128 ~ 126

Notation:

DBSE rel

Description:

If the carry flag C is set ($C = 1$) or the zero flag is set ($Z = 1$), place the branch address PC + rel (relative of the first byte after the Branch instruction) in the program counter PC. All condition flags and the cache mode flag M remain unchanged.

Then the instruction after the Delayed Branch instruction, called the delay instruction, is executed regardless of whether the delayed branch is taken or not taken.

When the delayed branch is not taken, the delay instruction is executed like a regular instruction. The PC and the ILC are updated accordingly and instruction execution proceeds sequentially.

When the delayed branch is taken, the delay instruction is executed before execution proceeds at the branch target. The PC (containing the delayed-branch target address) is not updated by the delay instruction. Any reference to the PC by the delay instruction references the delayed-branch target address.

Operation:

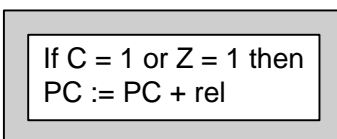

Exceptions:

None.

Delayed Branch**DBR**

Format:

PCrel format

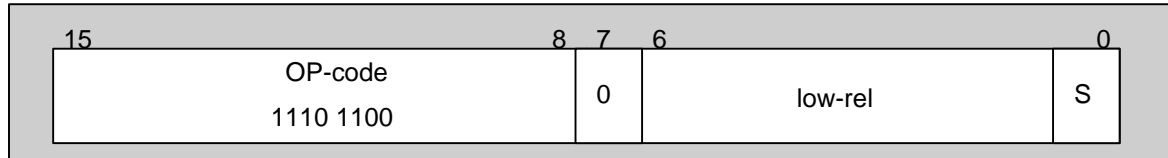

S: sign bit of rel

rel = 25 S // low-rel // 0

range -128 ~ 126

Notation:

DBR rel

Description:

Place the branch address $PC + rel$ (relative of the first byte after the Branch instruction) in the program counter PC. All condition flags and the cache mode flag M remain unchanged.

Then the instruction after the Delayed Branch instruction, called the delay instruction, is executed regardless of whether the delayed branch is taken or not taken

Operation:

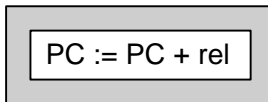

Exceptions:

None.

Delayed Branch on Smaller Than**DBST**

Format:

PCrel format

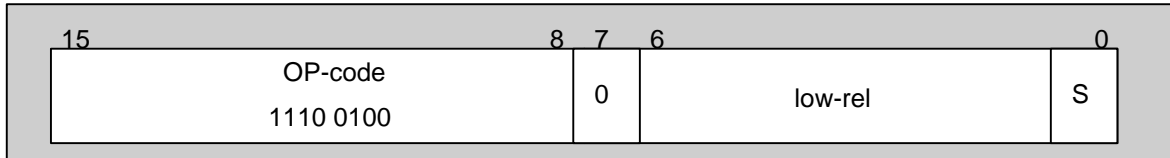

S: sign bit of rel

rel = 25 S // low-rel // 0

range -128 ~ 126

Notation:

DBST rel

Description:

If the carry flag C is set ($C = 1$), place the branch address $PC + rel$ (relative of the first byte after the Branch instruction) in the program counter PC. All condition flags and the cache mode flag M remain unchanged.

Then the instruction after the Delayed Branch instruction, called the delay instruction, is executed regardless of whether the delayed branch is taken or not taken.

When the delayed branch is not taken, the delay instruction is executed like a regular instruction. The PC and the ILC are updated accordingly and instruction execution proceeds sequentially.

When the delayed branch is taken, the delay instruction is executed before execution proceeds at the branch target. The PC (containing the delayed-branch target address) is not updated by the delay instruction. Any reference to the PC by the delay instruction references the delayed-branch target address.

Operation:

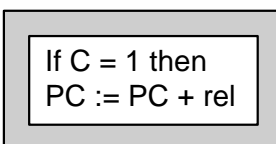

Exceptions:

None.

Delayed Branch on Overflow

DBV

Format:

PCrel format

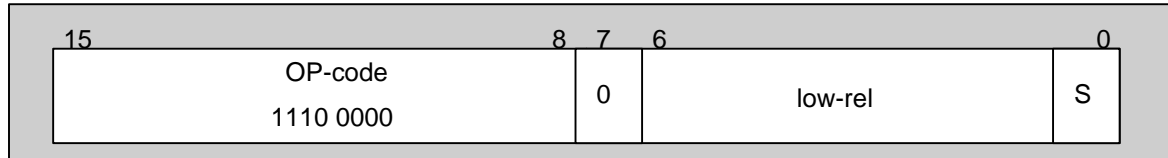

S: sign bit of rel

rel = 25 S // low-rel // 0

range -128 ~ 126

Notation:

DBV rel

Description:

If the overflow flag V is set ($V = 1$), place the branch address $PC + rel$ (relative of the first byte after the Branch instruction) in the program counter PC. All condition flags and the cache mode flag M remain unchanged.

Then the instruction after the Delayed Branch instruction, called the delay instruction, is executed regardless of whether the delayed branch is taken or not taken.

When the delayed branch is not taken, the delay instruction is executed like a regular instruction. The PC and the ILC are updated accordingly and instruction execution proceeds sequentially.

When the delayed branch is taken, the delay instruction is executed before execution proceeds at the branch target. The PC (containing the delayed-branch target address) is not updated by the delay instruction. Any reference to the PC by the delay instruction references the delayed-branch target address.

Operation:

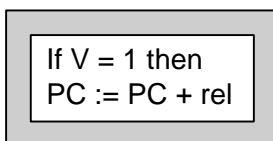

Exceptions:

None.

Delayed Branch on Zero**DBZ**

Format:

PCrel format

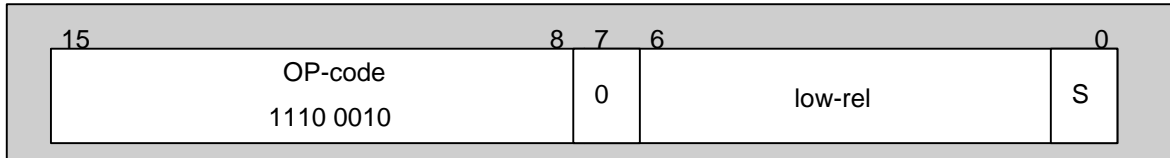

S: sign bit of rel

rel = 25 S // low-rel // 0

range -128 ~ 126

Notation:

DBZ rel

Description:

If the zero flag is set ($Z = 1$), place the branch address $PC + rel$ (relative of the first byte after the Branch instruction) in the program counter PC. All condition flags and the cache mode flag M remain unchanged.

Then the instruction after the Delayed Branch instruction, called the delay instruction, is executed regardless of whether the delayed branch is taken or not taken.

When the delayed branch is not taken, the delay instruction is executed like a regular instruction. The PC and the ILC are updated accordingly and instruction execution proceeds sequentially.

When the delayed branch is taken, the delay instruction is executed before execution proceeds at the branch target. The PC (containing the delayed-branch target address) is not updated by the delay instruction. Any reference to the PC by the delay instruction references the delayed-branch target address.

Operation:

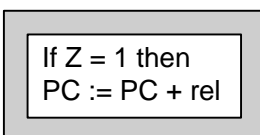

Exceptions:

None.

Floating-point Add (single precision)**FADD**

Format:

LL format

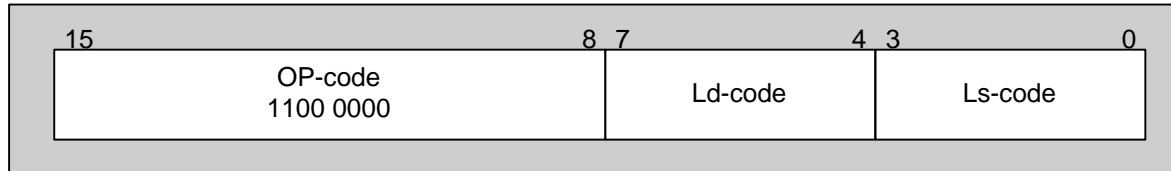

Ls-code encodes L0..L15 for Ls

Ld-code encodes L0..L15 for Ld

Notation:

FADD Ld, Ls

Description:

The source operand (Ls) is added to the destination operand (Ld), the result is placed in the destination register (Ld) and all condition flags remain unchanged to allow future concurrent execution.

The floating-point instructions comply with the ANSI/IEEE standard 754-1985. In the present version, they are executed as Software instructions.

This instruction uses single-precision operands and it must not be placed as delay instructions. A floating-point Not a Number (NaN) is encoded by bits 30..19 = all ones in the operand word containing the exponent; all other bits of the operand are ignored for differentiating a NaN from a non-NaN.

This instruction can raise any of the exceptions Invalid Operation, Division by Zero, Overflow, Underflow or Inexact.

Operation:

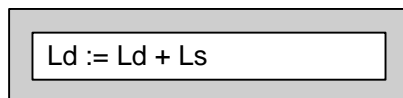

Exceptions:

Invalid Operation, Division by Zero, Overflow, Underflow or Inexact.

Floating-point Add (double precision)**FADDD**

Format:

LL format

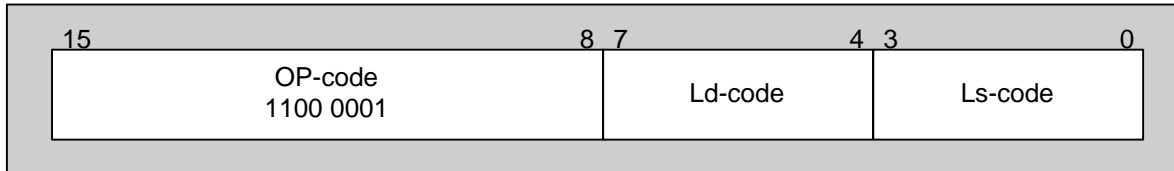

Ls-code encodes L0..L15 for Ls

Ld-code encodes L0..L15 for Ld

Notation:

FADDD Ld, Ls

Description:

The source operand (Ls//Lsf) is added to the destination operand (Ld//Ldf), the result is placed in the destination register (Ld//Ldf) and all condition flags remain unchanged to allow future concurrent execution.

The floating-point instructions comply with the ANSI/IEEE standard 754-1985. In the present version, they are executed as Software instructions.

This instruction uses double-precision operands and it must not be placed as delay instructions. A floating-point Not a Number (NaN) is encoded by bits 30..19 = all ones in the operand word containing the exponent; all other bits of the operand are ignored for differentiating a NaN from a non-NaN.

This instruction can raise any of the exceptions Invalid Operation, Division by Zero, Overflow, Underflow or Inexact.

Operation:

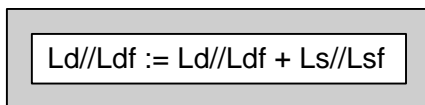

Exceptions:

Invalid Operation, Division by Zero, Overflow, Underflow or Inexact.

Floating-point Compare (single precision)**FCMP**

Format:

LL format

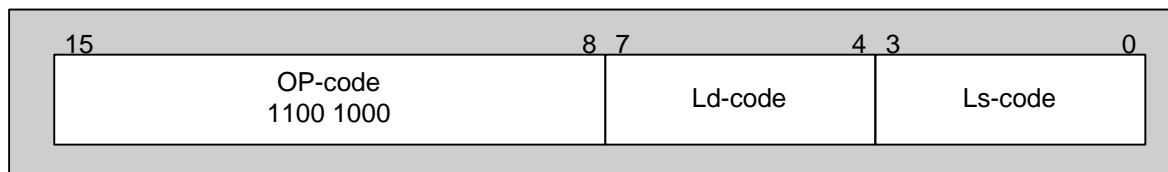

Ls-code encodes L0..L15 for Ls

Ld-code encodes L0..L15 for Ld

Notation:

FCMPU Ld, Ls

Description:

Two operands are compared by subtracting the source operand from the destination operand and all condition flags remain unchanged to allow future concurrent execution.

The floating-point instructions comply with the ANSI/IEEE standard 754-1985. In the present version, they are executed as Software instructions.

This instruction uses single-precision operands and it must not be placed as delay instructions. A floating-point Not a Number (NaN) is encoded by bits 30..19 = all ones in the operand word containing the exponent; all other bits of the operand are ignored for differentiating a NaN from a non-NaN.

This instruction can raise only the Invalid Operation exception (at unordered). If the data type of two operands are different (unordered) the Invalid Operation exception is occurred.

Operation:

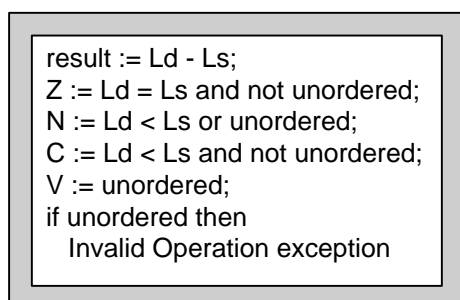

Exceptions:

Invalid Operation.

Floating-point Compare (double precision)**FCMPD**

Format:

LL format

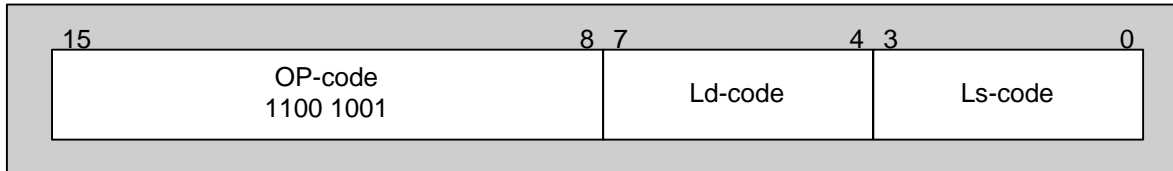

Ls-code encodes L0..L15 for Ls

Ld-code encodes L0..L15 for Ld

Notation:

FCMPD Ld, Ls

Description:

Two operands are compared by subtracting the source operand from the destination operand and all condition flags remain unchanged to allow future concurrent execution.

The floating-point instructions comply with the ANSI/IEEE standard 754-1985. In the present version, they are executed as Software instructions.

This instruction uses double-precision operands and it must not be placed as delay instructions. A floating-point Not a Number (NaN) is encoded by bits 30..19 = all ones in the operand word containing the exponent; all other bits of the operand are ignored for differentiating a NaN from a non-NaN.

This instruction can raise only the Invalid Operation exception (at unordered). If the data type of two operands are different (unordered) the Invalid Operation exception is occurred.

Operation:

```

result := Ld//Ldf - Ls//Lsf;
Z := Ld//Ldf = Ls//Lsf and not unordered;
N := Ld//Ldf < Ls//Lsf or unordered;
C := Ld//Ldf < Ls//Lsf and not unordered;
V := unordered;
if unordered then
    Invalid Operation exception;

```

Exceptions:

Invalid Operation.

Floating-point Compare without exception (single precision) **FCMPU**

Format:

LL format

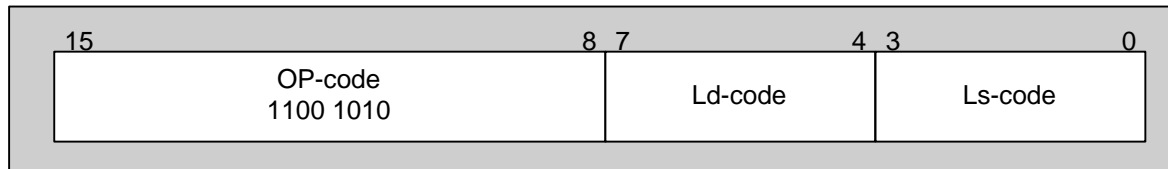

Ls-code encodes L0..L15 for Ls

Ld-code encodes L0..L15 for Ld

Notation:

FCMPU Ld, Ls

Description:

Two operands are compared by subtracting the source operand from the destination operand and all condition flags remain unchanged to allow future concurrent execution.

The floating-point instructions comply with the ANSI/IEEE standard 754-1985. In the present version, they are executed as Software instructions.

This instruction uses single-precision operands and it must not be placed as delay instructions. A floating-point Not a Number (NaN) is encoded by bits 30..19 = all ones in the operand word containing the exponent; all other bits of the operand are ignored for differentiating a NaN from a non-NaN.

This instruction can raise any exception.

Operation:

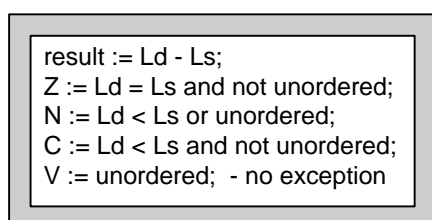

Exceptions:

None.

Floating-point Compare without exception (double precision) FCMPUD

Format:

LL format

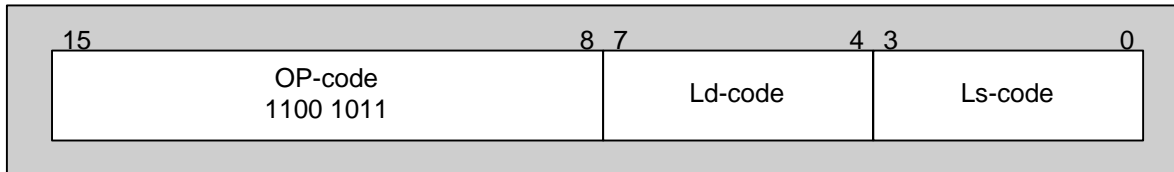

Ls-code encodes L0..L15 for Ls

Ld-code encodes L0..L15 for Ld

Notation:

FCMPUD Ld, Ls

Description:

Two operands are compared by subtracting the source operand from the destination operand and all condition flags remain unchanged to allow future concurrent execution.

The floating-point instructions comply with the ANSI/IEEE standard 754-1985. In the present version, they are executed as Software instructions.

This instruction uses double-precision operands and it must not be placed as delay instructions. A floating-point Not a Number (NaN) is encoded by bits 30..19 = all ones in the operand word containing the exponent; all other bits of the operand are ignored for differentiating a NaN from a non-NaN.

This instruction can raise only the Invalid Operation exception (at unordered). If the data type of two operands are different (unordered) the Invalid Operation exception is occurred.

Operation:

```

result := Ld//Ldf - Ls//Lsf;
Z := Ld//Ldf = Ls//Lsf and not unordered;
N := Ld//Ldf < Ls//Lsf or unordered;
C := Ld//Ldf < Ls//Lsf and not unordered;
V := unordered; - no exception

```

Exceptions:

None.

Floating-point Convert (double => single)**FCVT**

Format:

LL format

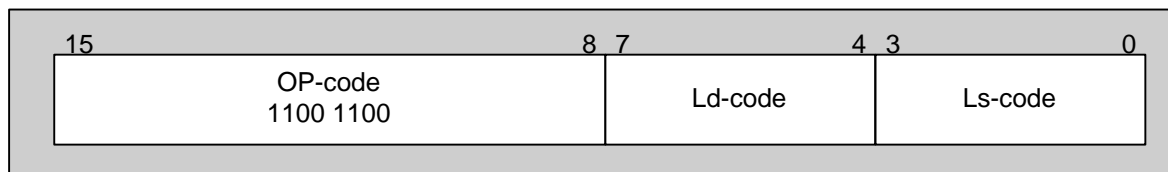

Ls-code encodes L0..L15 for Ls

Ld-code encodes L0..L15 for Ld

Notation:

FCVT Ld, Ls

Description:

The double-precision source operand (Ls//Lsf) is converted to the single-precision destination operand (Ld) and all condition flags remain unchanged to allow future concurrent execution.

The floating-point instructions comply with the ANSI/IEEE standard 754-1985. In the present version, they are executed as Software instructions.

This instruction uses single-precision operands and it must not be placed as delay instructions. A floating-point Not a Number (NaN) is encoded by bits 30..19 = all ones in the operand word containing the exponent; all other bits of the operand are ignored for differentiating a NaN from a non-NaN.

This instruction can raise any of the exceptions Invalid Operation, Division by Zero, Overflow, Underflow or Inexact.

Operation:

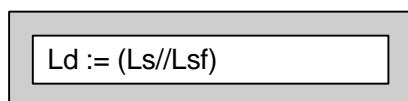

Exceptions:

Invalid Operation, Division by Zero, Overflow, Underflow or Inexact.

Floating-point Convert (single => double)**FCVTD**

Format:

LL format

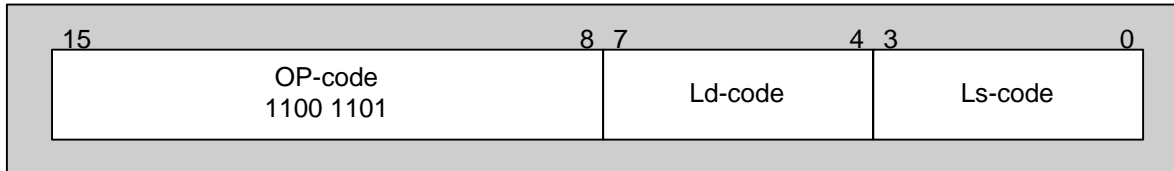

Ls-code encodes L0..L15 for Ls

Ld-code encodes L0..L15 for Ld

Notation:

FCVTD Ld, Ls

Description:

The single-precision source operand (Ls) is converted to the double-precision destination operand (Ld//Ldf) and all condition flags remain unchanged to allow future concurrent execution.

The floating-point instructions comply with the ANSI/IEEE standard 754-1985. In the present version, they are executed as Software instructions.

This instruction uses double-precision operands and it must not be placed as delay instructions. A floating-point Not a Number (NaN) is encoded by bits 30..19 = all ones in the operand word containing the exponent; all other bits of the operand are ignored for differentiating a NaN from a non-NaN.

This instruction can raise any of the exceptions Invalid Operation, Division by Zero, Overflow, Underflow or Inexact.

Operation:

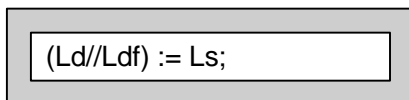

Exceptions:

Invalid Operation, Division by Zero, Overflow, Underflow or Inexact.

Floating-point Division (single precision)**FDIV**

Format:

LL format

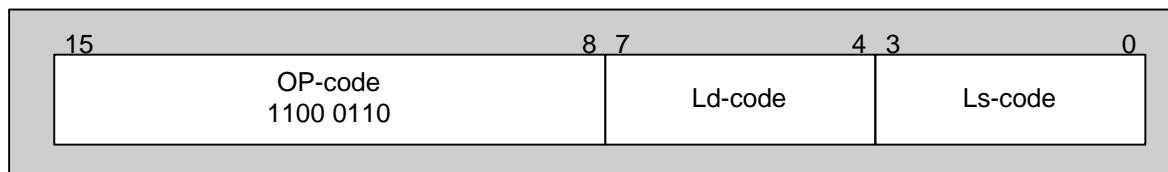

Ls-code encodes L0..L15 for Ls

Ld-code encodes L0..L15 for Ld

Notation:

FDIV Ld, Ls

Description:

The destination operand (Ld) is divided by the source operand (Ls), the result is placed in the destination register (Ld) and all condition flags remain unchanged to allow future concurrent execution.

The floating-point instructions comply with the ANSI/IEEE standard 754-1985. In the present version, they are executed as Software instructions.

This instruction uses single-precision operands and it must not be placed as delay instructions. A floating-point Not a Number (NaN) is encoded by bits 30..19 = all ones in the operand word containing the exponent; all other bits of the operand are ignored for differentiating a NaN from a non-NaN.

This instruction can raise any of the exceptions Invalid Operation, Division by Zero, Overflow, Underflow or Inexact.

Operation:

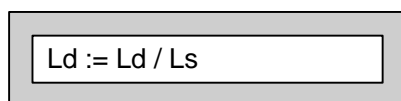

Exceptions:

Invalid Operation, Division by Zero, Overflow, Underflow or Inexact.

Floating-point Division (double precision)**FDIVD**

Format:

LL format

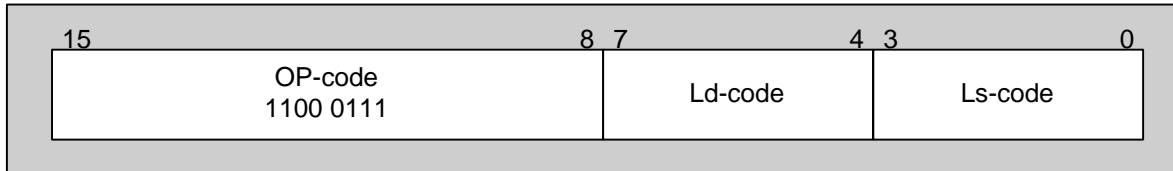

Ls-code encodes L0..L15 for Ls

Ld-code encodes L0..L15 for Ld

Notation:

FDIVD Ld, Ls

Description:

The destination operand (Ld//Ldf) is divided by the source operand (Ls//Lsf), the result is placed in the destination register (Ld//Ldf) and all condition flags remain unchanged to allow future concurrent execution.

The floating-point instructions comply with the ANSI/IEEE standard 754-1985. In the present version, they are executed as Software instructions.

This instruction uses double-precision operands and it must not be placed as delay instructions. A floating-point Not a Number (NaN) is encoded by bits 30..19 = all ones in the operand word containing the exponent; all other bits of the operand are ignored for differentiating a NaN from a non-NaN.

This instruction can raise any of the exceptions Invalid Operation, Division by Zero, Overflow, Underflow or Inexact.

Operation:

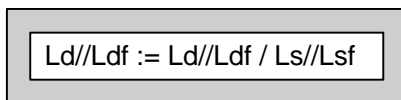

Exceptions:

Invalid Operation, Division by Zero, Overflow, Underflow or Inexact.

Fetch**FETCH**

Format:

Rn format

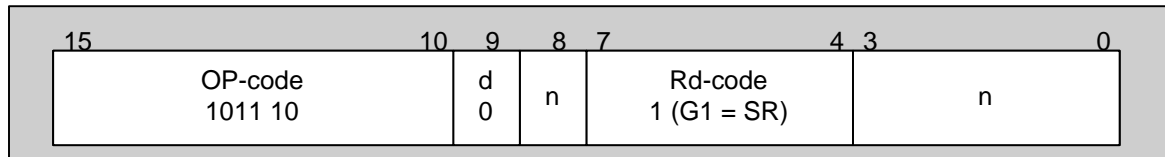

d = 0: Rd-code encoded R0..R15 for Rd

d = 1: Rd-code encoded L0..L15 for Rd

n: Bit 8 // bits 3..0 encode n = 0..31

Notation:

FETCH Ld, Ls

Description:

The instruction execution is halted until a number of at least $n/2 + 1$ ($n = 0, 2, 4, \dots, 30$) instruction halfwords succeeding the Fetch instruction are prefetched in the instruction cache. The number of $n/2$ is derived by using bits 4..1 of n, bit 0 of n must be zero.

The Fetch instruction must not be placed as a delay instruction; when the preceding branch is taken, the prefetch is undefined.

The Fetch instruction shares the basic OP-code SETxx, it is differentiated by denoting the SR for the Rd-code.

Operation:

FETCH 1	Wait until 1 instruction halfword is fetched
FETCH 2	Wait until 2 instruction halfwords are fetched
.....	
FETCH 16	Wait until 2 instruction halfwords are fetched

Exceptions:

None.

Floating-point Multiplication (single precision)**FMUL**

Format:

LL format

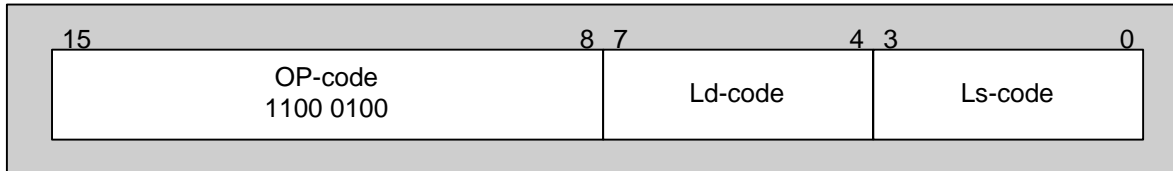

Ls-code encodes L0..L15 for Ls

Ld-code encodes L0..L15 for Ld

Notation:

FMUL Ld, Ls

Description:

The source operand (Ls) and destination operand(Ld) are multiplied, the result is placed in the destination register (Ld) and all condition flags remain unchanged to allow future concurrent execution.

The floating-point instructions comply with the ANSI/IEEE standard 754-1985. In the present version, they are executed as Software instructions.

This instruction uses single-precision operands and it must not be placed as delay instructions. A floating-point Not a Number (NaN) is encoded by bits 30..19 = all ones in the operand word containing the exponent; all other bits of the operand are ignored for differentiating a NaN from a non-NaN.

This instruction can raise any of the exceptions Invalid Operation, Division by Zero, Overflow, Underflow or Inexact.

Operation:

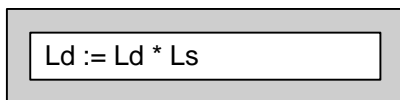

Exceptions:

Invalid Operation, Division by Zero, Overflow, Underflow or Inexact.

Floating-point Multiplication (double precision)**FMULD**

Format:

LL format

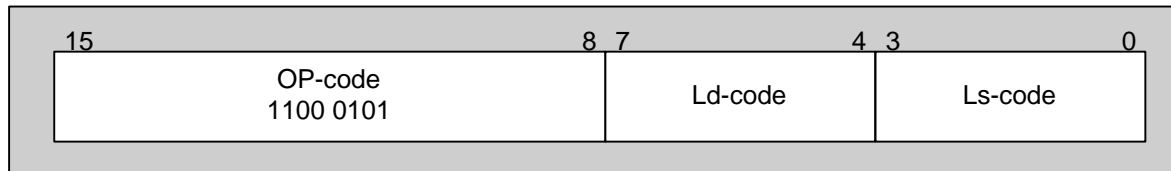

Ls-code encodes L0..L15 for Ls

Ld-code encodes L0..L15 for Ld

Notation:

FMULD Ld, Ls

Description:

The source operand (Ls//Lsf) and destination operand(Ld//Ldf) are multiplied, the result is placed in the destination register (Ld//Ldf) and all condition flags remain unchanged to allow future concurrent execution.

The floating-point instructions comply with the ANSI/IEEE standard 754-1985. In the present version, they are executed as Software instructions.

This instruction uses double-precision operands and it must not placed as delay instructions. A floating-point Not a Number (NaN) is encoded by bits 30..19 = all ones in the operand word containing the exponent; all other bits of the operand are ignored for differentiating a NaN form a non-NaN.

This instruction can raise any of the exceptions Invalid Operation, Division by Zero, Overflow, Underflow or Inexact.

Operation:

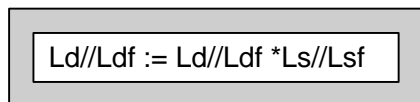

Exceptions:

Invalid Operation, Division by Zero, Overflow, Underflow or Inexact.

Frame**FRAME**

Format:

LL format

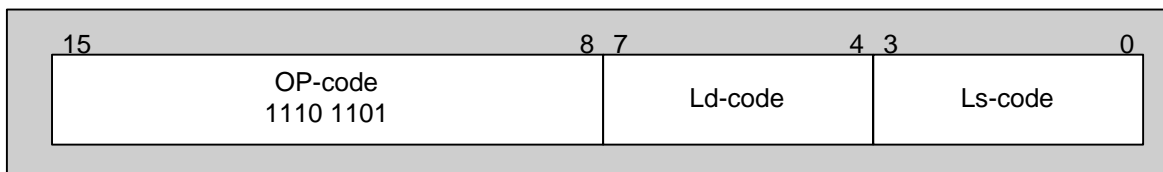

Ls-code encodes L0..L15 for Ls

Ld-code encodes L0..L15 for Ld

Notation:

FRAME Ld, Ls

Description:

A Frame instruction restructures the current stack frame by

- decreasing the frame pointer FP to include (optionally) passed parameters in the local register addressing range; the first parameter passed is then addressable as L0;
- resetting the frame length FL to the actual number of registers needed for the current stack frame.

The frame pointer FP is decreased by the value of the Ls-code and the Ld-code is placed in the frame length FL (FL = 0 is always interpreted as FL = 16). Then the difference (available number of registers) - (required number of registers + 10) is evaluated and interpreted as a signed 7-bit integer.

If difference is not negative, all the registers required plus the reserve of 10 fit into the register part of the stack; no further action is needed and the Frame instruction is finished.

If difference is negative, the content of the old stack pointer SP is compared with the address in the upper stack bound UB. If the value in the SP is equal or higher than the value in the UB, a temporary flag is set. Then the contents of the number of local registers equal to the negative difference evaluated are pushed onto the memory part of the stack, beginning with the content of the local register addressed absolutely by SP(7..2) being pushed onto the location addressed by the SP.

All condition flags remain unchanged.

Attention: The Frame instruction must always be the first instruction executed in a function entered by a Call instruction, otherwise the Frame instruction could be separated from the preceding Call instruction by an Interrupt, Parity Error, Extended Overflow of Trace exception.

Frame (continued)**FRAME**

Operation:

```
FP := FP - Ls-code;
FL := Ld code;
M := 0;
difference (6..0) := SP(8..2) + (64-16) - (FP + FL);
if difference ≥ 0 then continue at next instruction
else temporary flag := SP > UB;
  repeat memory SP := register SP(7..2)^;
  SP := SP + 4;
  difference := difference + 1;
until difference = 0;
if temporary flag = 1 then trap => Range Error
```

Exceptions:

Range Error exception.

Floating-point Subtract (single precision)**FSUB**

Format:

LL format

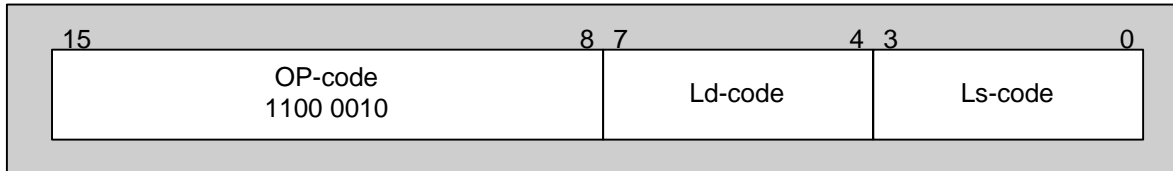

Ls-code encodes L0..L15 for Ls

Ld-code encodes L0..L15 for Ld

Notation:

FSUB Ld, Ls

Description:

The source operand (Ls) is subtracted from the destination operand (Ld), the result is placed in the destination register (Ld) and all condition flags remain unchanged to allow future concurrent execution.

The floating-point instructions comply with the ANSI/IEEE standard 754-1985. In the present version, they are executed as Software instructions.

This instruction uses single-precision operands and it must not be placed as delay instructions. A floating-point Not a Number (NaN) is encoded by bits 30..19 = all ones in the operand word containing the exponent; all other bits of the operand are ignored for differentiating a NaN from a non-NaN.

This instruction can raise any of the exceptions Invalid Operation, Division by Zero, Overflow, Underflow or Inexact.

Operation:

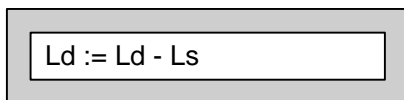

Exceptions:

Invalid Operation, Division by Zero, Overflow, Underflow or Inexact.

Floating-point Subtract (double precision)**FSUBD**

Format:

LL format

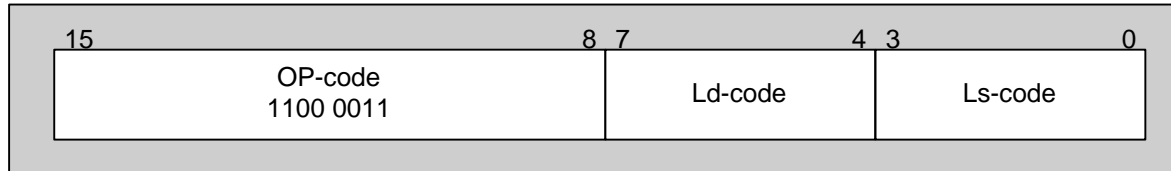

Ls-code encodes L0..L15 for Ls

Ld-code encodes L0..L15 for Ld

Notation:

FSUBD Ld, Ls

Description:

The source operand (Ls//Lsf) is subtracted from the destination operand (Ld//Ldf), the result is placed in the destination register (Ld//Ldf) and all condition flags remain unchanged to allow future concurrent execution.

The floating-point instructions comply with the ANSI/IEEE standard 754-1985. In the present version, they are executed as Software instructions.

This instruction uses double-precision operands and it must not be placed as delay instructions. A floating-point Not a Number (NaN) is encoded by bits 30..19 = all ones in the operand word containing the exponent; all other bits of the operand are ignored for differentiating a NaN from a non-NaN.

This instruction can raise any of the exceptions Invalid Operation, Division by Zero, Overflow, Underflow or Inexact.

Operation:

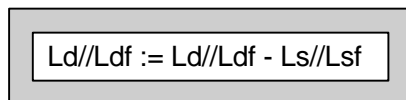

Exceptions:

Invalid Operation, Division by Zero, Overflow, Underflow or Inexact.

Load (absolute address mode)**LD_{xx}.A**

Format:

RRdis format

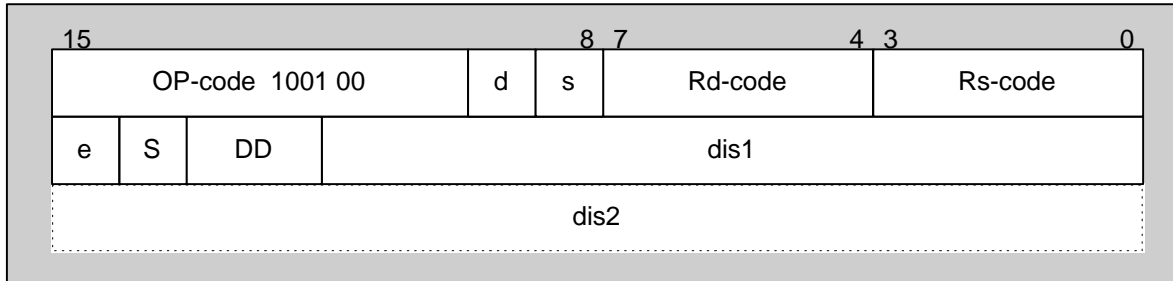

s = 0: Rs-code encodes G0..G15 for Rs, s = 1: Rs-code encodes L0..L15 for Rs
 d = 0: Rd-code encodes G0..G15 for Rd, d = 1: Rd-code encodes L0..L15 for Rd
 S : Sign bit of dis, e = 0: dis = 20S // dis1(range -4,096..4,095)
 e = 1: dis = 4S // dis1 // dis2 (range -268,435,456...268,435,455)
 DD: D-code, D13..D12 encode data types at memory instructions

Notation:

LD_{xx}.A 0, Rs, dis

Description:

The Load instruction of absolute address mode transfers data from the addressed memory location, displacement dis is used as an address, into a register Rs or a register pair Rs//Rsf.

The displacement dis is used as an address into memory address space. Rd must denote the SR to differentiate this mode from the displacement address mode; the content of the SR is not used.

Data type xx is with

BU: Byte unsigned HU: Halfword unsigned W: Word
 BS: Byte signed HS: Halfword signed D: Double-word

Operation:

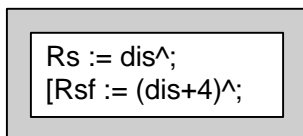

Exceptions:

None.

Load Double Word (post-increment address mode)**LDD.P**

Format:

LR format

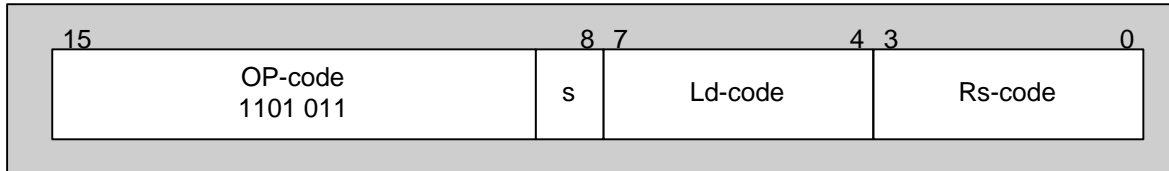

s = 0: Rs-code encodes G0..G15 for Rs

s = 1: Rs-code encodes L0..L15 for Rs

Ld-code encodes L0..L15 for Ld

Notation:

LDD.P Ld, Rs

Description:

The Load instruction of post-increment address mode transfers data from the addressed memory location, Ld is used as an address, into a register pair Rs//Rsf.

The content of the destination register Ld is used as an address into memory address space, then Ld is incremented according to the specified data size of double-word memory instruction by 8, regardless of any exception occurring. Ld is incremented by 8 at the first memory cycle.

Operation:

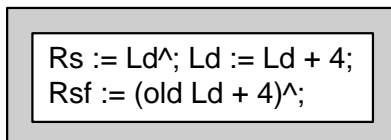

Exceptions:

None.

Load Double Word (register address mode)**LDD.R**

Format:

LR format

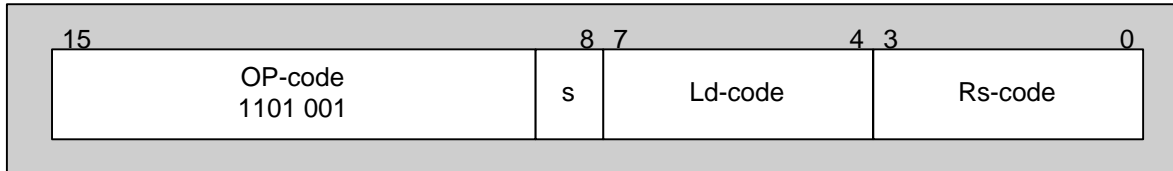

s = 0: Rs-code encodes G0..G15 for Rs

s = 1: Rs-code encodes L0..L15 for Rs

Ld-code encodes L0..L15 for Ld

Notation:

LDD.R Ld, Rs

Description:

The Load instruction of register address mode transfers data from the addressed memory location, Ld is used as an address, into a register pair Rs//Rsf.

The content of the destination register Ld is used as an address into memory address space.

Operation:

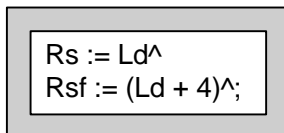

Exceptions:

None.

Load (displacement address mode)**LD_{xx}.D**

Format:

RRdis format

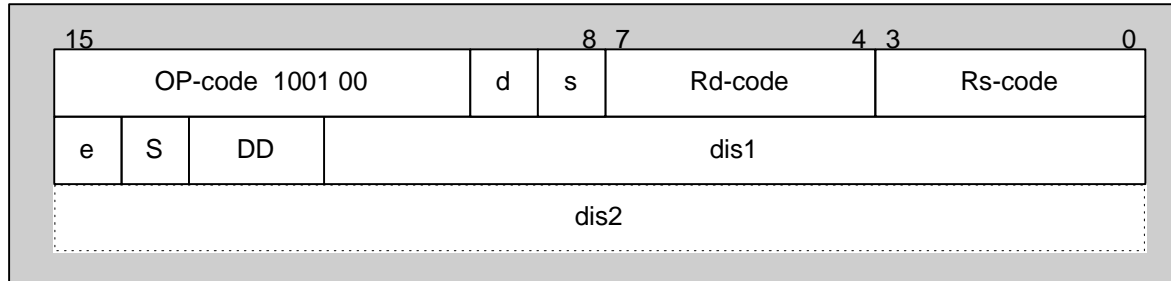

s = 0: Rs-code encodes G0..G15 for Rs, s = 1: Rs-code encodes L0..L15 for Rs

d = 0: Rd-code encodes G0..G15 for Rd, d = 1: Rd-code encodes L0..L15 for Rd

S : Sign bit of dis, e = 0: dis = 20S // dis1(range -4,096..4,095)

e = 1: dis = 4S // dis1 // dis2 (range -268,435,456...268,435,455)

DD: D-code, D13..D12 encode data types at memory instructions

Notation:

LD_{xx}.D Rd, Rs, dis

Description:

The Load instruction of displacement address mode transfers data from the addressed memory location, Rd plus a signed dis is used as an address, into a register Rs or a register pair Rs//Rsf.

The sum of the contents of the destination register Rd plus a signed displacement dis is used as an address into memory address space.

Rd may denote any register except the SR; Rd not denoting the SR differentiates this mode from the absolute address mode.

Data type xx is with

BU: Byte unsigned HU: Halfword unsigned W: Word

BS: Byte signed HS: Halfword signed D: Double-word

Operation:

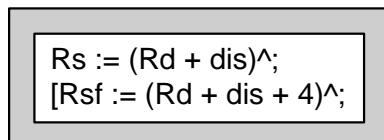

Exceptions:

None.

Load (I/O absolute address mode)**LDxx.IOA**

Format:

RRdis format

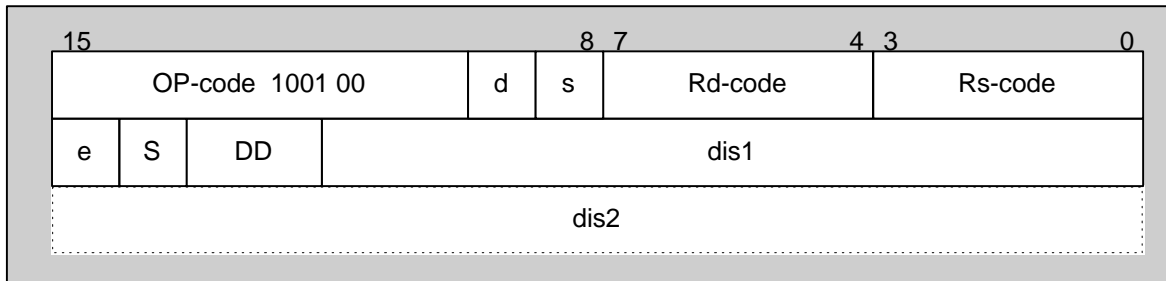

s = 0: Rs-code encodes G0..G15 for Rs, s = 1: Rs-code encodes L0..L15 for Rs
 d = 0: Rd-code encodes G0..G15 for Rd, d = 1: Rd-code encodes L0..L15 for Rd
 S : Sign bit of dis, e = 0: dis = 20S // dis1(range -4,096..4,095)
 e = 1: dis = 4S // dis1 // dis2 (range -268,435,456...268,435,455)
 DD: D-code, D13..D12 encode data types at memory instructions

Notation:

LDxx.IOA 0, Rs, dis

Description:

The Load instruction of I/O absolute address mode transfers data from the addressed memory location, dis is used as an address, into a register Rs or a register pair Rs//Rsf.

The displacement dis is used as an address into I/O address space.

Rd must denote the SR to differentiate this mode from the I/O displacement address mode; the content of the SR is not used.

Data type xx is with

W: Word D: Double-word

Operation:

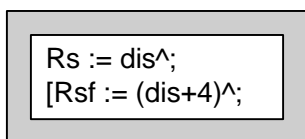

Exceptions:

None.

Load (I/O displacement address mode)**LD_{xx}.IOD**

Format:

RRdis format

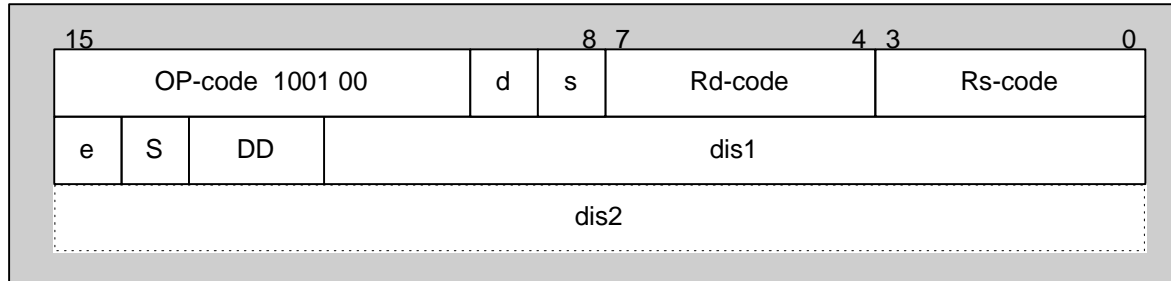

s = 0: Rs-code encodes G0..G15 for Rs, s = 1: Rs-code encodes L0..L15 for Rs

d = 0: Rd-code encodes G0..G15 for Rd, d = 1: Rd-code encodes L0..L15 for Rd

S : Sign bit of dis, e = 0: dis = 20S // dis1(range -4,096..4,095)

e = 1: dis = 4S // dis1 // dis2 (range -268,435,456...268,435,455)

DD: D-code, D13..D12 encode data types at memory instructions

Notation:

LD_{xx}.IOD Rd, Rs, dis

Description:

The Load instruction of I/O displacement address mode transfers data from the addressed memory location, Rd plus a signed dis is used as an address, into a register Rs or a register pair Rs//Rsf.

The sum of the contents of the destination register Rd plus a signed displacement dis is used as an I/O address into memory address space.

Rd may denote any register except the SR; Rd not denoting the SR differentiates this mode from the I/O absolute address mode.

Data type xx is with

W: Word D: Double-word

Operation:

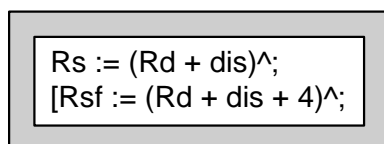

Exceptions:

None.

Load (next address mode)**LDxx.N**

Format:

RRdis format

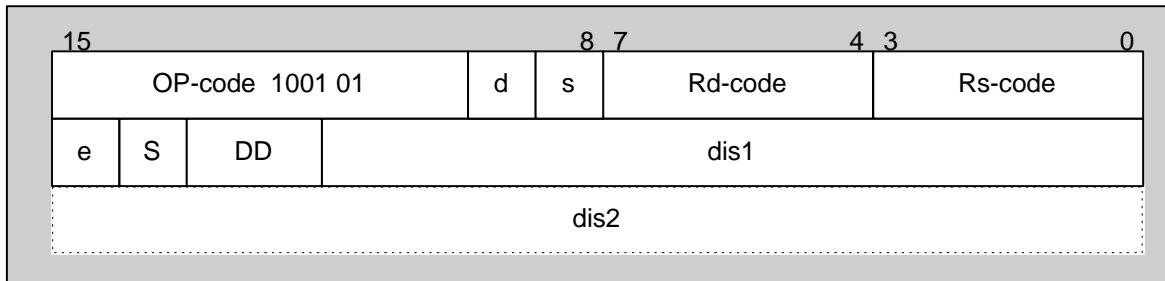

s = 0: Rs-code encodes G0..G15 for Rs, s = 1: Rs-code encodes L0..L15 for Rs
 d = 0: Rd-code encodes G0..G15 for Rd, d = 1: Rd-code encodes L0..L15 for Rd
 S : Sign bit of dis, e = 0: dis = 20S // dis1 (range -4,096..4,095)
 e = 1: dis = 4S // dis1 // dis2 (range -268,435,456...268,435,455)
 DD: D-code, D13..D12 encode data types at memory instructions

Notation:

LDxx.N Rd, Rs, dis

Description:

The Load instruction of next address mode transfers data from the addressed memory location, Rd is used as an address, into a register Rs or a register pair Rs//Rsf.

The content of the destination register Rd is used as an address into memory address space, then Rd is incremented by the signed displacement dis regardless of any exception occurring. At a double-word data type, Rd is incremented at the first memory cycle.

Rd must not denote the PC or the SR.

In the case of all data types except byte, bit zero of dis is treated as zero for the calculation of $Rd + dis$.

Data type xx is with

BU: Byte unsigned HU: Halfword unsigned W: Word

BS: Byte signed HS: Halfword signed D: Double-word

Operation:

$Rs := Rd^{\wedge}$; $Rd := Rd + dis$
 $[Rsf := (old Rd + 4)^{\wedge}]$;

Exceptions:

None.

Load Word (post-increment address mode)**LDW.P**

Format:

LR format

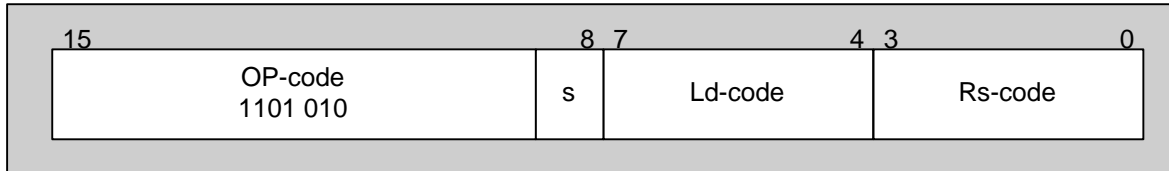

s = 0: Rs-code encodes G0..G15 for Rs

s = 1: Rs-code encodes L0..L15 for Rs

Ld-code encodes L0..L15 for Ld

Notation:

LDW.P Ld, Rs

Description:

The Load instruction of post-increment address mode transfers data from the addressed memory location, Ld is used as an address, into a register Rs.

The content of the destination register Ld is used as an address into memory address space, then Ld is incremented according to the specified data size of a word by 4, regardless of any exception occurring.

Operation:

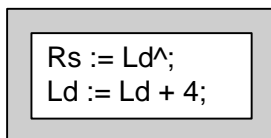

Exceptions:

None.

Load Word (register address mode)**LDW.R**

Format:

LR format

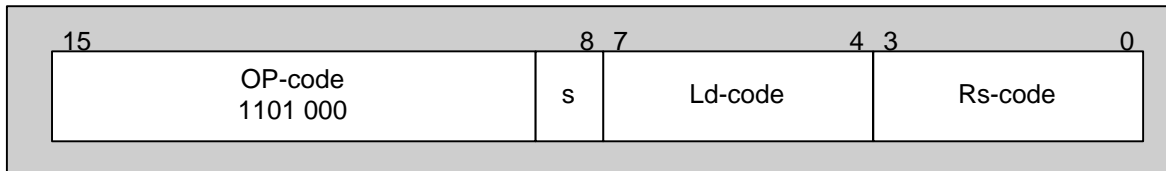

s = 0: Rs-code encodes G0..G15 for Rs

s = 1: Rs-code encodes L0..L15 for Rs

Ld-code encodes L0..L15 for Ld

Notation:

LDW.R Ld, Rs

Description:

The Load instruction of register address mode transfers data from the addressed memory location, Ld is used as an address, into a register Rs.

The content of the destination register Ld is used as an address into memory address space.

Operation:

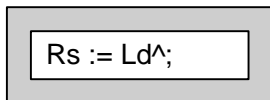

Exceptions:

None.

Load Word (stack address mode)**LDW.S**

Format:

RRdis format

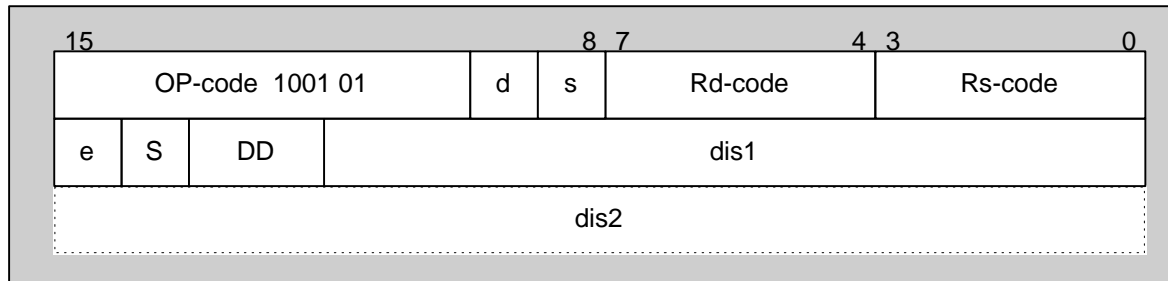

s = 0: Rs-code encodes G0..G15 for Rs, s = 1: Rs-code encodes L0..L15 for Rs

d = 0: Rd-code encodes G0..G15 for Rd, d = 1: Rd-code encodes L0..L15 for Rd

S : Sign bit of dis, e = 0: dis = 20S // dis1(range -4,096..4,095)

e = 1: dis = 4S // dis1 // dis2 (range -268,435,456...268,435,455)

DD: D-code, D13..D12 encode data types at memory instructions

Notation:

LDW.S Rd, Rs, dis

Description:

The Load instruction of stack address mode transfers data from the addressed memory location, Ld is used as an address, into a register Rs.

The content of the destination register Rd is used as stack address, then Rd is incremented by dis regardless of any exception occurred.

Operation:

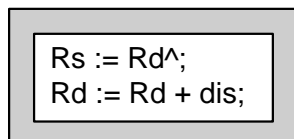

Exceptions:

None.

Mask**MASK**

Format:

RRconst format

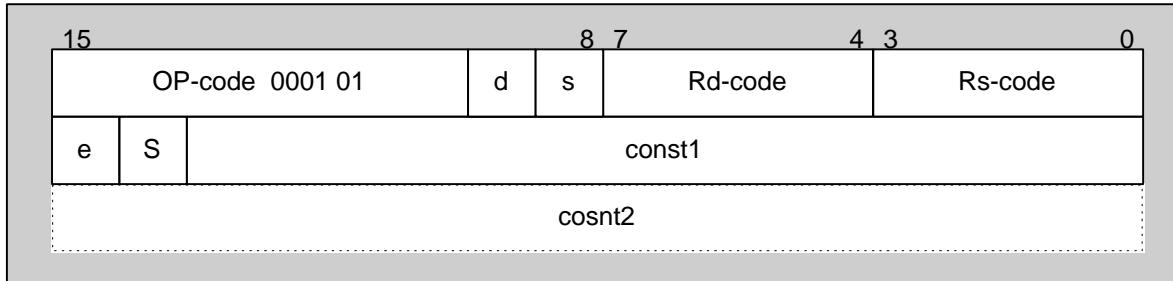

s = 0: Rs-code encodes G0..G15 for Rs, s = 1: Rs-code encodes L0..L15 for Rs

d = 0: Rd-code encodes G0..G15 for Rd, d = 1: Rd-code encodes L0..L15 for Rd

S : Sign bit of dis, e = 0: const = 18S // const1 (range -16,384..16,383)

e = 1: const = 2S // const1 // const2 (range -1,073,741,824...1,073,741,823)

Notation:

MASK Rd, Rs, const

Description:

The result of a bitwise logical AND of the source operand and the immediate operand is placed in the destination register and the Z flag is set or cleared accordingly.

All operands and the result are interpreted as bit-string of 32 bits each.

Operation:

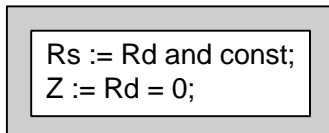

Exceptions:

None.

Move Word**MOV**

Format:

RR format

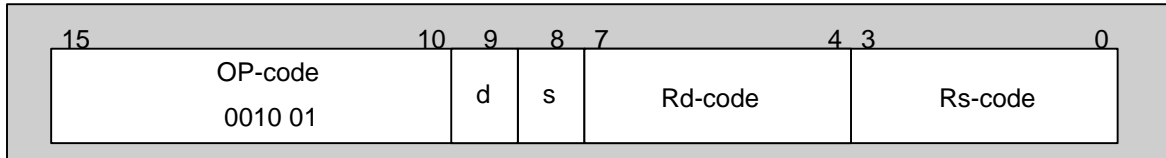

s = 0: Rs-code encoded G0..G15 for Rs

s = 1: Rs-code encoded L0..L15 for Rs

d = 0: Rd-code encoded G0..G15 for Rd

d = 1: Rd-code encoded L0..L15 for Rd

Notation:

MOV Rd, Rs

Description:

The source operand is copied to the destination register and condition flags are set or cleared accordingly.

Operation:

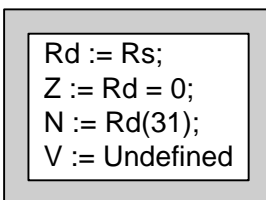

Exceptions:

None.

Move Double Word**MOVD**

Format:

RR format

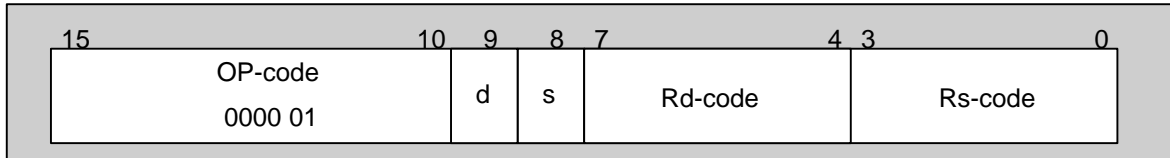

s = 0: Rs-code encoded G0..G15 for Rs
s = 1: Rs-code encoded L0..L15 for Rs
d = 0: Rd-code encoded G0..G15 for Rd
d = 1: Rd-code encoded L0..L15 for Rd

Notation:

MOVD Rd, Rs

MOVD Rd, 0 (When SR is denoted as a source operand)

Description:

The double-word source operand is copied to the double-word destination register pair and condition flags are set or cleared accordingly. The high-order word in Rs is copied first.

When the SR is denoted as a source operand, the source operand is supplied as zero regardless of the content of SR//G2. When the PC is denoted as destination, the Return instruction RET is executed instead of the Move Double-Word instruction.

Operation:

<p>If Rd does not denote PC and Rs does not denote SR then</p> <p>Rd := Rs; Rdf := Rsf; Z := Rd//Rsf = 0; N := Rd(31); V := Undefined</p>	<p>If Rd does not denote PC and Rs denotes SR then</p> <p>Rd := 0; Rdf := 0; Z := 1; N := 0; V := Undefined</p>
---	---

Exceptions:

None.

Move Word Immediate**MOVI**

Format:

Rimm format

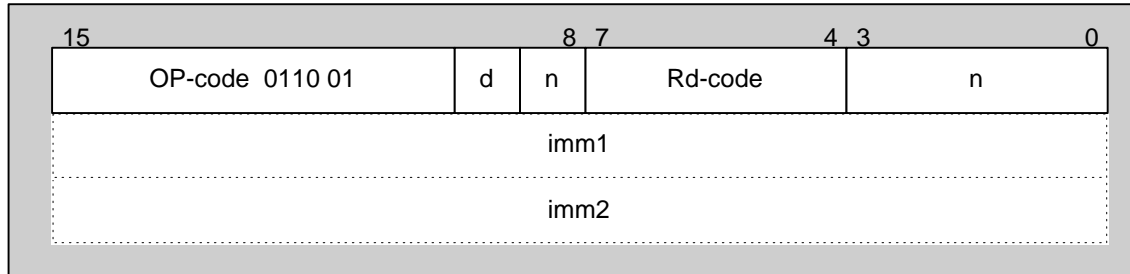

d = 0: Rd-code encodes G0..G15 for Rd, d = 1: Rd-code encodes L0..L15 for Rd

n: Bit 8 // bits 3..0 encode n = 0..31, see Table 2.3 Encoding of Immediate Values for encoding of imm

Notation:

MOVI Rd, imm

Description:

The immediate operand is copied to the destination register and condition flags are set or cleared accordingly.

Operation:

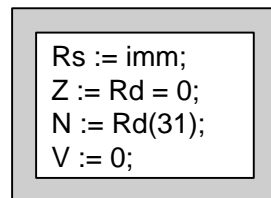

Exceptions:

None.

Multiply Word**MUL**

Format:

RR format

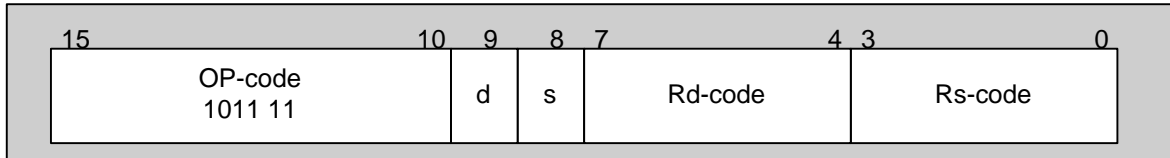

s = 0: Rs-code encoded G0..G15 for Rs
s = 1: Rs-code encoded L0..L15 for Rs
d = 0: Rd-code encoded G0..G15 for Rd
d = 1: Rd-code encoded L0..L15 for Rd

Notation:

MUL Rd, Rs

Description:

The source operand and the destination operand are multiplied, the low-order word of the product is placed in the destination register (the high-order product word is not evaluated) and the condition flags are set or cleared according to the single-word product.

Both operands are either signed or unsigned integers, the product is a single-word integer.

The result is undefined if the PC or the SR is denoted.

Operation:

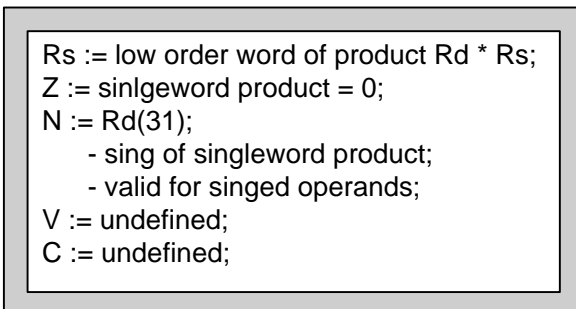

Exceptions:

None.

Multiply Signed Double-Word**MULS**

Format:

RR format

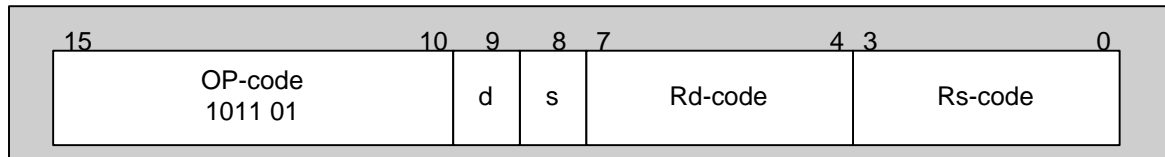

s = 0: Rs-code encoded G0..G15 for Rs

s = 1: Rs-code encoded L0..L15 for Rs

d = 0: Rd-code encoded G0..G15 for Rd

d = 1: Rd-code encoded L0..L15 for Rd

Notation:

MULS Rd, Rs

Description:

The source operand and the destination operand are multiplied, the double-word product is placed in the destination register pair (the destination register expanded by the register following it) and the condition flags are set or cleared according to the double-word product.

Both operands are signed integers and the product is a signed double-word integer.

The result is undefined if the PC or the SR is denoted.

Operation:

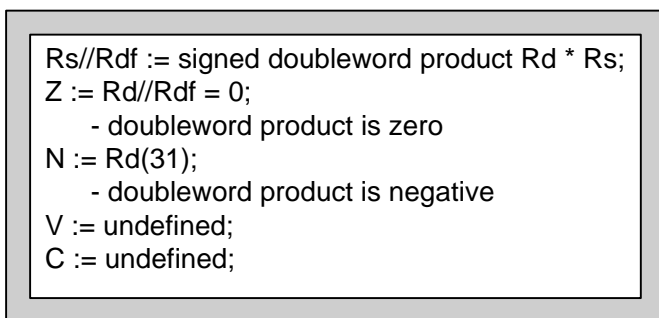

Exceptions:

None.

Multiply Unsigned Double-Word**MULU**

Format:

RR format

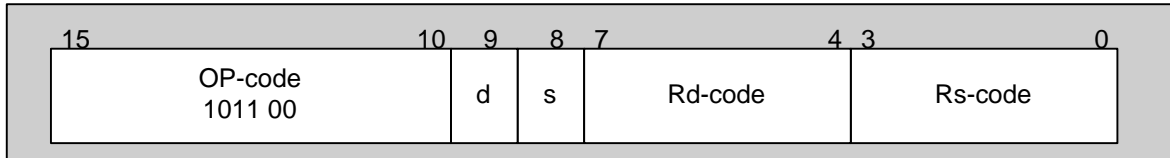

s = 0: Rs-code encoded G0..G15 for Rs
 s = 1: Rs-code encoded L0..L15 for Rs
 d = 0: Rd-code encoded G0..G15 for Rd
 d = 1: Rd-code encoded L0..L15 for Rd

Notation:

MULU Rd, Rs

Description:

The source operand and the destination operand are multiplied, the double-word product is placed in the destination register pair (the destination register expanded by the register following it) and the condition flags are set or cleared according to the double-word product.

Both operands are unsigned integers and the product is a unsigned double-word integer.

The result is undefined if the PC or the SR is denoted.

Operation:

Rs//Rdf := unsigned doubleword product Rd * Rs; Z := Rd//Rdf = 0; - doubleword product is zero N := Rd(31); V := undefined; C := undefined;
--

Exceptions:

None.

Negate (unsigned or unsigned)**NEG**

Format:

RR format

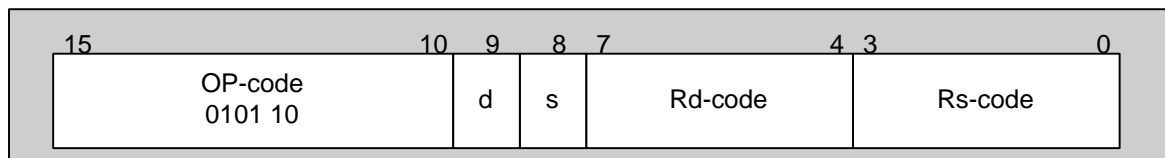

s = 0: Rs-code encoded G0..G15 for Rs

s = 1: Rs-code encoded L0..L15 for Rs

d = 0: Rd-code encoded G0..G15 for Rd

d = 1: Rd-code encoded L0..L15 for Rd

Notation:

NEG Rd, Rs

NEG Rd, C (when SR is denoted as a Rs)

Description:

The source operand (Rs) is subtracted from zero, the result is placed in the destination register (Rd) and the condition flag are set or cleared accordingly.

Both operands and the result are interpreted as either all signed or all unsigned integers.

When the SR is denoted as a source operand, carry flag C is negated instead of the SR.

Operation:

<p>When Rs is not SR</p> <p>Rd := - Rs; Z := Rd = 0; N := Rd(31); V := overflow; C := carry;</p>	<p>When Rs is SR</p> <p>Rd := - C; Z := Rd = 0; N := Rd(31); V := overflow; C := carry; if C is set then Rd := -1; else Rd := 0;</p>
--	--

Exceptions:

None.

Negate (signed)**NEGS**

Format:

RR format

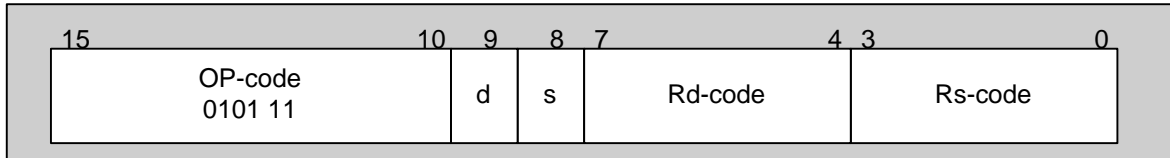

s = 0: Rs-code encoded G0..G15 for Rs
s = 1: Rs-code encoded L0..L15 for Rs
d = 0: Rd-code encoded G0..G15 for Rd
d = 1: Rd-code encoded L0..L15 for Rd

Notation:

NEGS Rd, Rs

NEGS Rd, C (when SR is denoted as a Rs)

Description:

The source operand (Rs) is subtracted from zero, the result is placed in the destination register (Rd) and the condition flag are set or cleared accordingly.

Both operands and the result are interpreted as all signed.

When the SR is denoted as a source operand, carry flag C is negated instead of the SR.

Operation:

<p>When Rs is not SR</p> <p>Rd := - Rs; Z := Rd = 0; N := Rd(31); V := overflow; if overflow then trap => Range Error</p>	<p>When Rs is SR</p> <p>Rd := - C; Z := Rd = 0; N := Rd(31); V := overflow; C := carry; if C is set then Rd := -1; else Rd := 0;</p>
---	---

Exceptions:

Overflow: Range Error.

No Operation**NOP**

Format:

RR format

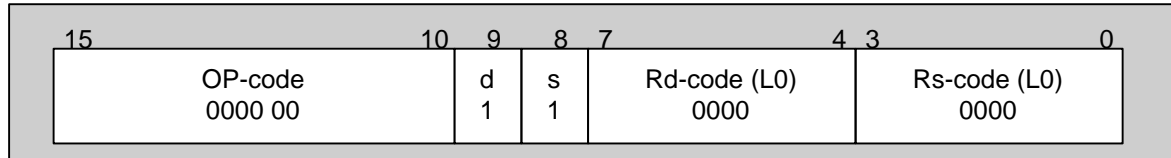

Notation:

NOP

Description:

The instruction `CHK L0, L0` cannot cause any trap. Since `CHK` leaves all registers and condition flags unchanged, it can be used as a No Operation instruction.

Operation:

None.

Exceptions:

None.

Invert**NOT**

Format:

RR format

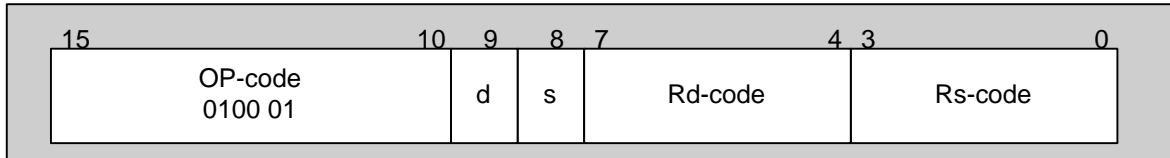

s = 0: Rs-code encoded G0..G15 for Rs
s = 1: Rs-code encoded L0..L15 for Rs
d = 0: Rd-code encoded G0..G15 for Rd
d = 1: Rd-code encoded L0..L15 for Rd

Notation:

NOT Rd, Rs

Description:

The source operand (Rs) is placed bitwise inverted in the designation register and the Z flag is set or cleared accordingly.

The source operand and the result are interpreted as bit-strings of 32 bits each.

Operation:

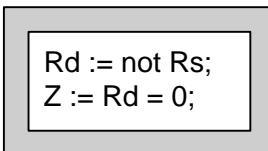

Exceptions:

None.

OR**OR**

Format:

RR format

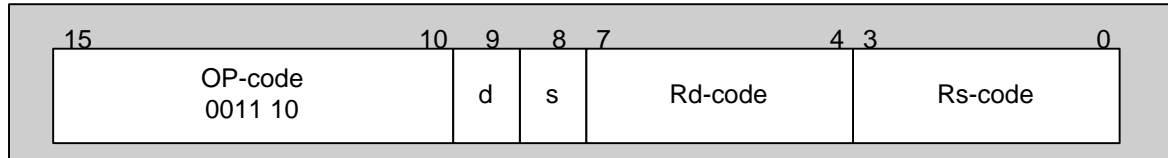

s = 0: Rs-code encoded G0..G15 for Rs

s = 1: Rs-code encoded L0..L15 for Rs

d = 0: Rd-code encoded G0..G15 for Rd

d = 1: Rd-code encoded L0..L15 for Rd

Notation:

OR Rd, Rs

Description:

The result of a bitwise logical OR of the source operand and the destination operand is placed in the destination register and the Z flag is set or cleared accordingly.

All operands and the result are interpreted as bit-strings of 32 bits each.

Operation:

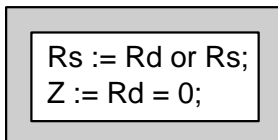

Exceptions:

None.

OR Immediate**ORI**

Format:

Rimm format

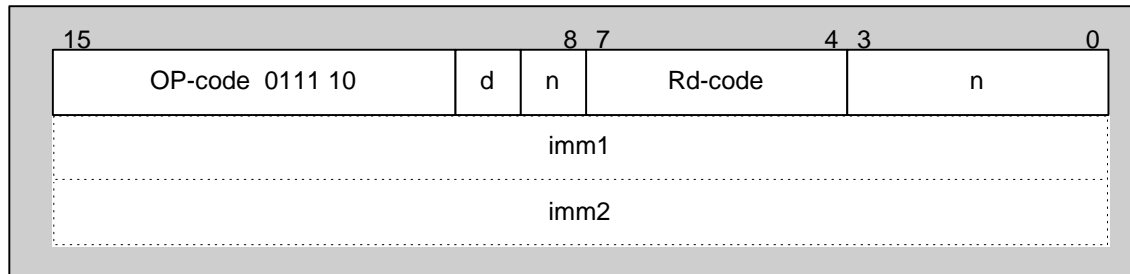

d = 0: Rd-code encodes G0..G15 for Rd, d = 1: Rd-code encodes L0..L15 for Rd

n: Bit 8 // bits 3..0 encode n = 0..31, see Table 2.3 Encoding of Immediate Values for encoding of imm

Notation:

ORI Rd, imm

Description:

The result of a bitwise logical OR of the immediate operand and the destination operand is placed in the destination register and the Z flag is set or cleared accordingly.

All operands and the result are interpreted as bit-strings of 32 bits each.

Operation:

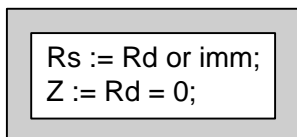

Exceptions:

None.

Return**RET**

Format:

RR format

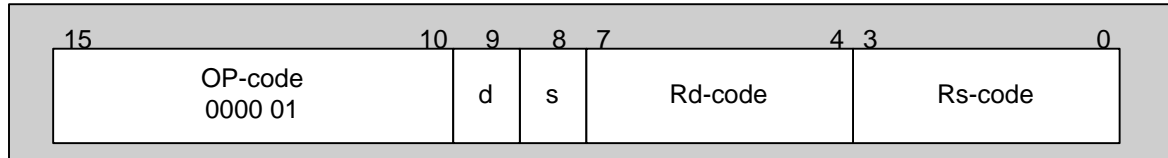

s = 0: Rs-code encoded G0..G15 for Rs

s = 1: Rs-code encoded L0..L15 for Rs

d = 0: Rd-code encoded G0..G15 for Rd

d = 1: Rd-code encoded L0..L15 for Rd

Notation:

RET PC, Rs

Description:

The Return instruction returns control from a subprogram entered through a Call, Trap or Software instruction or an exception to the instruction located at the return address and restores the status from the saved return status.

The source operand pair Rs//Rsf is placed in the register pair PC//SR. The program counter PC is restored first from Rs. Then all bits of the status register SR are replaced by Rsf; except the supervisor flag S, which is restored from bit zero of Rs and except the instruction length code ILC, which is cleared to zero.

The Return instruction shares its basic OP-code with the Move Double-Word instruction. It is differentiated from it by denoting the PC as destination register Rd.

Operation:

```

old S := S; old L := L;
PC := Rs(31..1)//0;
SR := Rs(31..32)//00//Rs(0)//Rsf(17..0); - ILC := 0; S := Rs(0);
If ( old S = 0 and S = 1 ) or ( S=0 and old L= 0 and L = 1 ) then trap => Privilege Error;
difference(6..0) := FP - SP(8..2); - difference is signed, difference(6) = sign bit
If difference > 0 then continue at next instructio;
else
  repeat
    SP := SP -4; register SP(7..2)^ := memory SP^;
    difference := difference + 1;
  until difference = 0;

```

Exceptions:

Privilege Error.

Rotate Left**ROL**

Format:

LL format

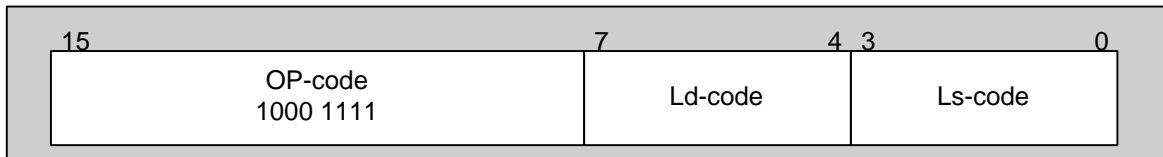

Ls-code encodes L0..L15 for Ls

Ld-code encodes L0..L15 for Ld

Notation:

ROL Ld, Ls

Description:

The destination operand is shifted left by a number of bit positions and the bits shifted out are inserted in the vacated bit positions; thus, the destination operand is rotated. The condition flags are set or cleared accordingly. Bits 4..0 of the source operand specify a rotation by 0..31 bit positions; bits 31..5 of the source operand are ignored.

Operation:

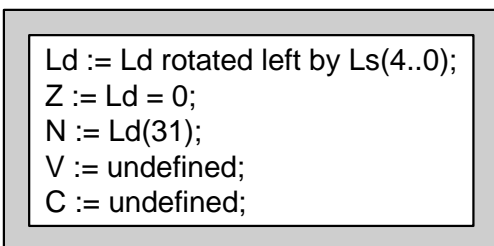

Exceptions:

None.

Shift Right (Signed Single Word)**SAR**

Format:

LL format

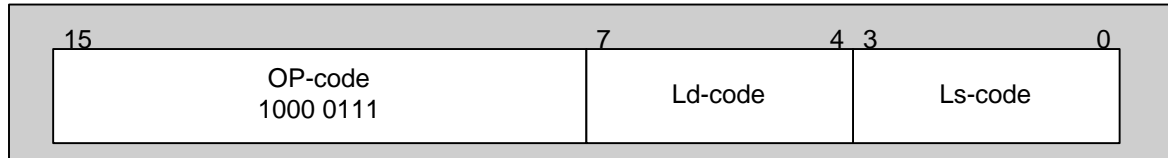

Ls-code encodes L0..L15 for Ls
Ld-code encodes L0..L15 for Ld

Notation:

SAR Ld, Ls

Description:

The destination operand is shifted right by a number of bit positions specified by bits 4..0 of the source operand as a shift by 0..31. The higher-order bits of the source operand are ignored. The destination operand is interpreted as a signed integer.

The Shift Right instruction inserts sign bits in the vacated bit positions at the left.

Operation:

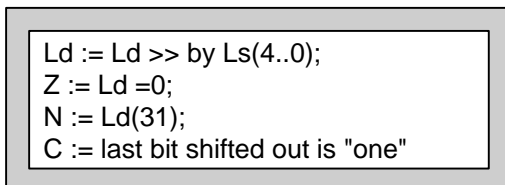

Exceptions:

None.

Shift Right (Signed Double Word)**SARD**

Format:

LL format

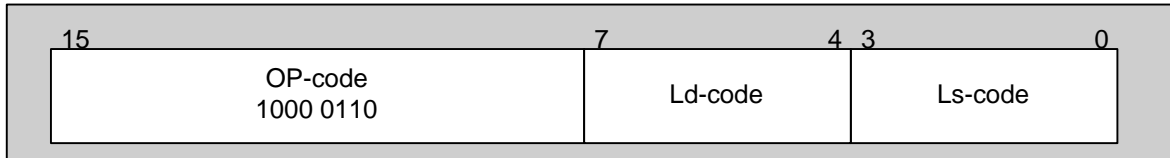

Ls-code encodes L0..L15 for Ls
 Ld-code encodes L0..L15 for Ld

Notation:

SARD Ld, Ls

Description:

The destination operand is shifted right by a number of bit positions specified by bits 4..0 of the source operand as a shift by 0..31. The higher-order bits of the source operand are ignored. The destination operand is interpreted as a signed double-word integer.

The Shift Right instruction inserts sign bits in the vacated bit positions at the left.

The double-word Shift Right instruction executes in two cycles. The high-order operand in Ld is shifted first. The result is undefined if Ls denotes the same register as Ld or Ldf.

Operation:

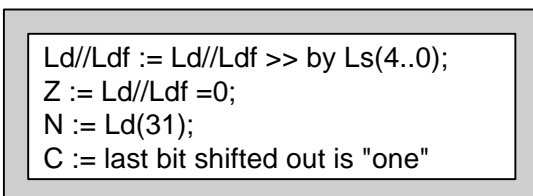

Exceptions:

None.

Shift Right Immediate (Signed Double Word)**SARDI**

Format:

Ln format

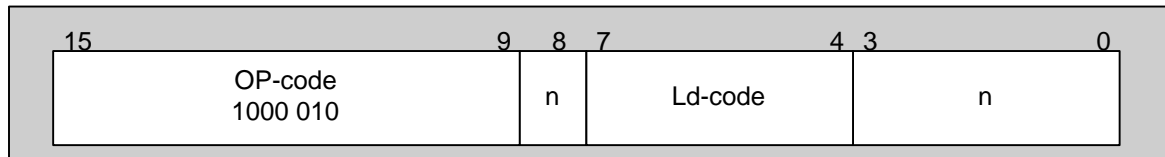

Ld-code encodes L0..L15 for Ld

n: Bit 8/bit 3..0 encode n = 0..31

Notation:

SARDI Ld, n

Description:

The destination operand is shifted right by a number of bit positions specified by $n = 0..31$ as a shift by $0..31$. The destination operand is interpreted as a signed double-word integer.

The Shift Right instruction inserts sign bits in the vacated bit positions at the left.

The double-word Shift Right instruction executes in two cycles. The high-order operand in Ld is shifted first. The result is undefined if Ls denotes the same register as Ld or Ldf.

Operation:

<p>Ld//Ldf := Ld//Ldf >> by n; Z := Ld//Ldf = 0; N := Ld(31); C := last bit shifted out is "one"</p>

Exceptions:

None.

Shift Right Immediate (Signed Single Word)**SARI**

Format:

Rn format

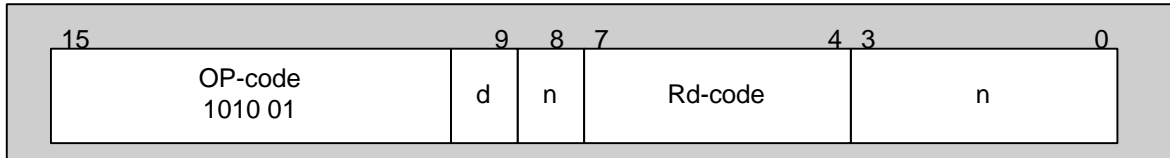

d = 0: Rd-code encodes G0..G15 for Rd

d = 1: Rd-code encodes L0..L15 for Rd

n: Bit 8//bit 3..0 encode n = 0..31

Notation:

SARI Ld, n

Description:

The destination operand is shifted right by a number of bit positions specified by $n = 0..31$ as a shift by $0..31$. The destination operand is interpreted as a signed integer.

The Shift Right instruction inserts sign bits in the vacated bit positions at the left.

Operation:

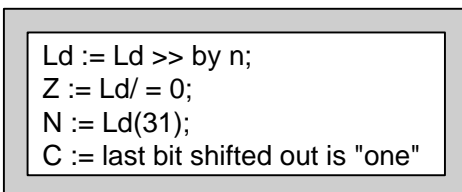

Exceptions:

None.

Shift Left (Single Word)**SHL**

Format:

LL format

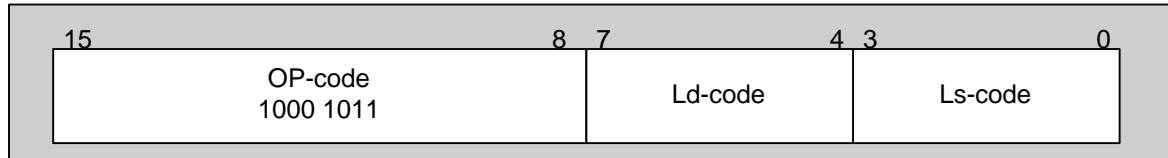

Ld-code encodes L0..L15 for Ld
Ls-code encodes L0..L15 for Ls

Notation:

SHL Ld, Ls

Description:

The destination operand is shifted left by a number of bit positions specified by bits 4..0 of the source operand as a shift by 0..31. The higher-order bits of the source operand are ignored. The destination operand is interpreted as a signed or unsigned integer.

The Shift Left instruction inserts zeros in the vacated bit positions at the right.

Operation:

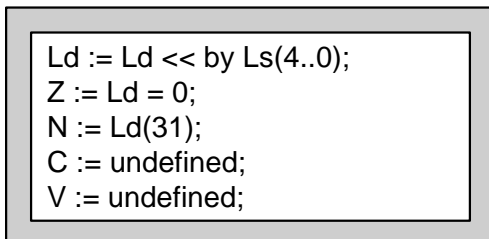

Exceptions:

None.

Shift Left (Double Word)**SHLD**

Format:

LL format

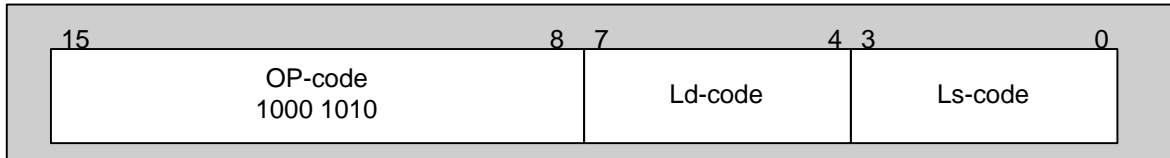

Ld-code encodes L0..L15 for Ld

Ls-code encodes L0..L15 for Ls

Notation:

SHLD Ld, Ls

Description:

The destination operand is shifted left by a number of bit positions specified by bits 4..0 of the source operand as a shift by 0..31. The higher-order bits of the source operand are ignored. The destination operand is interpreted as a signed or unsigned double-word integer.

The Shift Left instruction inserts zeros in the vacated bit positions at the right.

The double-word Shift Left instruction executes in two cycles. The high-order operand in Ld is shifted first. The result is undefined if Ls denotes the same register as Ld or Ldf.

Operation:

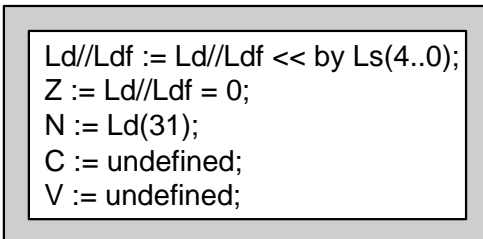

Exceptions:

None.

Shift Left Immediate (Double Word)**SHLDI**

Format:

Ln format

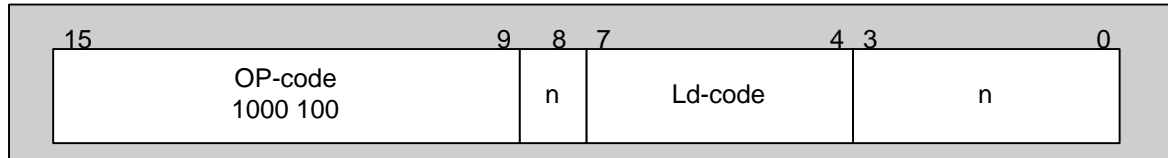

Ld-code encodes L0..L15 for Ld
 n: Bit 8/bit 3..0 encode n = 0..31

Notation:

SHLDI Ld, n

Description:

The destination operand is shifted left by a number of bit positions specified by $n = 0..31$ as a shift by $0..31$. The destination operand is interpreted as a signed or unsigned double-word integer.

The Shift Left instruction inserts zeros in the vacated bit positions at the right.

The double-word Shift Left instruction executes in two cycles. The high-order operand in Ld is shifted first. The result is undefined if Ls denotes the same register as Ld or Ldf.

Operation:

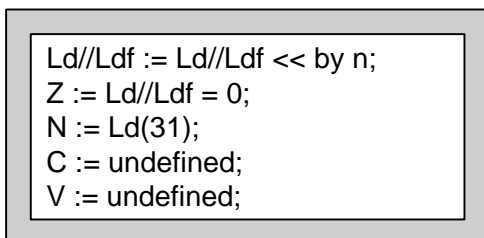

Exceptions:

None.

Shift Left Immediate (Single Word)**SHLI**

Format:

Rn format

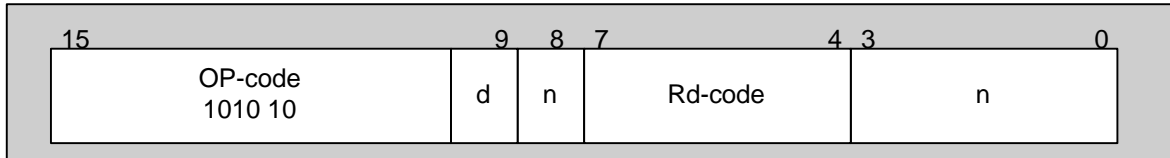

d = 0: Rd-code encodes G0..G15 for Rd

d = 1: Rd-code encodes L0..L15 for Rd

n: Bit 8//bit 3..0 encode n = 0..31

Notation:

SHLI Ld, n

Description:

The destination operand is shifted left by a number of bit positions specified by $n = 0..31$ as a shift by $0..31$. The destination operand is interpreted as a signed or unsigned integer.

The Shift left instruction inserts zeros in the vacated bit positions at the right.

Operation:

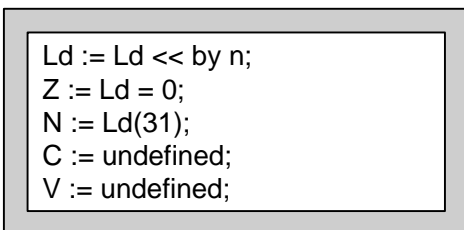

Exceptions:

None.

Shift Right (Unsigned Single Word)**SHR**

Format:

LL format

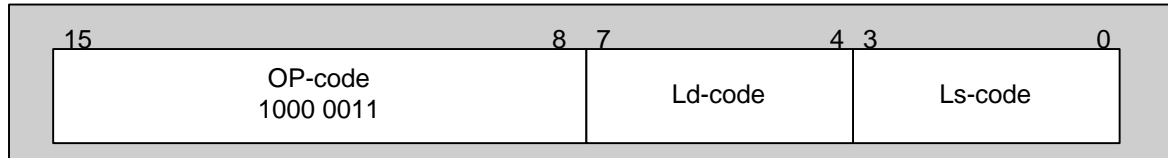

Ld-code encodes L0..L15 for Ld

Ls-code encodes L0..L15 for Ls

Notation:

SHR Ld, Ls

Description:

The destination operand is shifted right by a number of bit positions specified by bits 4..0 of the source operand as a shift by 0..31. The higher-order bits of the source operand are ignored. The destination operand is interpreted as a unsigned integer.

The Shift Right instruction inserts zeros in the vacated bit positions at the left.

Operation:

```
Ld := Ld >> by Ls(4..0);
Z := Ld = 0;
N := Ld(31);
C := last bit shifted out is "one"
```

Exceptions:

None.

Shift Right (Unsigned Double Word)**SHRD**

Format:

LL format

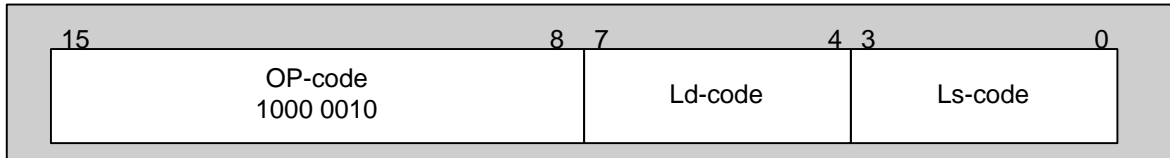

Ld-code encodes L0..L15 for Ld

Ls-code encodes L0..L15 for Ls

Notation:

SHRD Ld, Ls

Description:

The destination operand is shifted right by a number of bit positions specified by bits 4..0 of the source operand as a shift by 0..31. The higher-order bits of the source operand are ignored. The destination operand is interpreted as a unsigned double-word integer.

The Shift Right instruction inserts zeros in the vacated bit positions at the left.

The double-word Shift Right instruction executes in two cycles. The high-order operand in Ld is shifted first. The result is undefined if Ls denotes the same register as Ld or Ldf.

Operation:

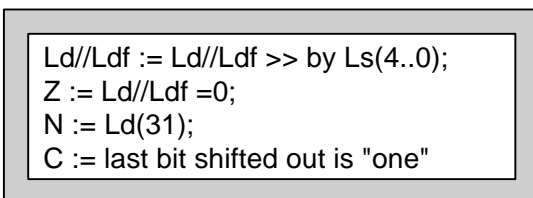

Exceptions:

None.

Shift Right Immediate (Unsigned Double Word)**SHRDI**

Format:

Ln format

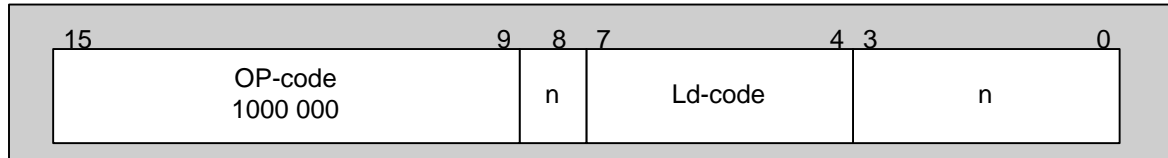

Ld-code encodes L0..L15 for Ld
n: Bit 8/bit 3..0 encode n = 0..31

Notation:

SHRDI Ld, n

Description:

The destination operand is shifted right by a number of bit positions specified by n = 0..31 as a shift by 0..31. The destination operand is interpreted as a unsigned double-word integer.

The Shift Right instruction inserts zeros in the vacated bit positions at the left.

The double-word Shift Right instruction executes in two cycles. The high-order operand in Ld is shifted first. The result is undefined if Ls denotes the same register as Ld or Ldf.

Operation:

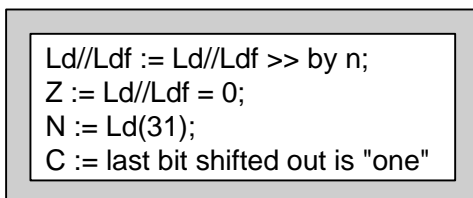

Exceptions:

None.

Shift Right Immediate (Unsigned Single Word)**SHRI**

Format:

Rn format

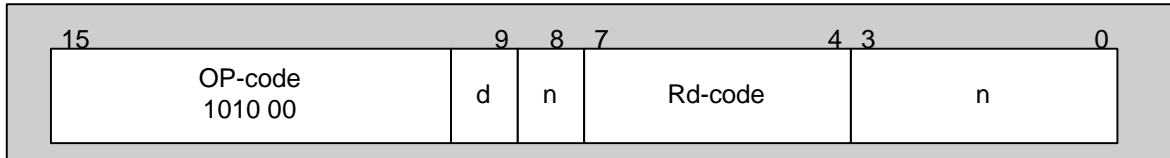

d = 0: Rd-code encodes G0..G15 for Rd

d = 1: Rd-code encodes L0..L15 for Rd

n: Bit 8//bit 3..0 encode n = 0..31

Notation:

SHRI Ld, n

Description:

The destination operand is shifted right by a number of bit positions specified by n = 0..31 as a shift by 0..31. The destination operand is interpreted as a unsigned integer.

The Shift Right instruction inserts zeros in the vacated bit positions at the left.

Operation:

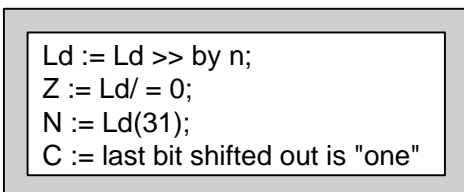

Exceptions:

None.

Set Stack Address**SETADR**

Format:

Rn format

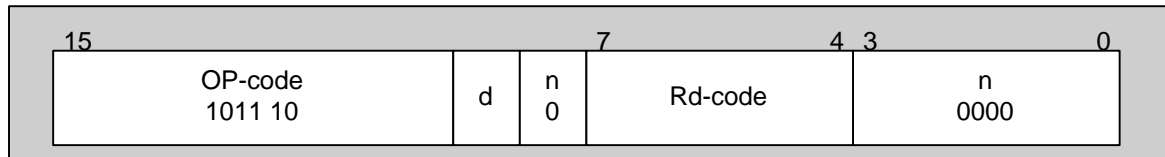

d = 0: Rd-code encodes G0..G15 for Rd

d = 1: Rd-code encodes L0..L15 for Rd

n: Bit 8 // bits 3..0 encode n = 0..31

Notation:

SETADR Rd

Description:

The Set Stack Address instruction calculates the stack address of the beginning of the current stack frame. L0..L15 of this frame can then be addressed relative to this stack address in the stack address mode with displacement values of 0..60 respectively.

The frame pointer FP is placed, expanded to the stack address, in the destination register. The FP itself and all condition flags remain unchanged. The expanded FP address is the address at which the content of L0 would be stored if pushed onto the memory part of the stack.

The Set Stack Address instruction shares the basic OP-code SETxx, it is differentiated by n = 0 and not denoting the SR or the PC.

Operation:

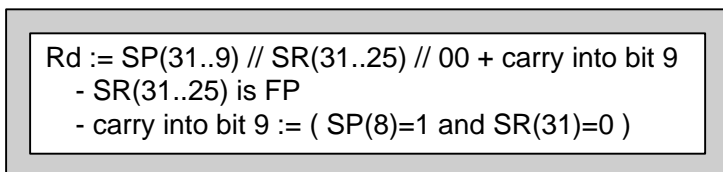

Exceptions:

None.

Set Conditional Instruction

SETxx

Format:

Rn format

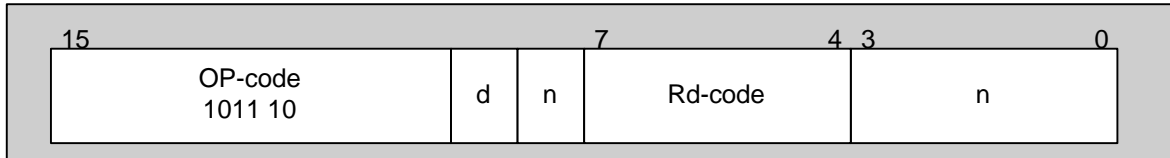

d = 0: Rd-code encodes G0..G15 for Rd

d = 1: Rd-code encodes L0..L15 for Rd

n: Bit 8 // bits 3..0 encode n = 0..31

Notation:

SETxx Rd

Description:

The destination register is set or cleared according to the states of the condition flags specified by n. The condition flags themselves remain unchanged.

The Set Conditional instruction share the basic OP-code SETxx, they are differentiated by n = 1..31 and not denoting the SR or the PC.

- n = 0 while not denoting the SR or the PC differentiates the Set Stack Address instruction.
- n = 1..31 while not denoting the SR or the PC differentiates the Set Conditional instruction.
- Denoting the SR differentiates the Fetch instruction.
- Denoting the PC is reserved for future use.

Operation:

n	Notation	or	Alternative	Operation	
1	Reserved				
2	SET1		Rd	Rd := 1;	
3	SET0		Rd	Rd := 0;	
4	SETLE		Rd	if N = 1 or Z = 1 then Rd := 1 else Rd := 0;	
5	SETGT		Rd	if N = 0 and Z = 0 then Rd := 1 else Rd := 0;	
6	SETLT		Rd	SETN Rd	if N = 1 then Rd := 1 else Rd := 0;
7	SETGE		Rd	SETNN Rd	if N = 0 then Rd := 1 else Rd := 0;
8	SETSE		Rd	if C = 1 or Z = 1 then Rd := 1 else Rd := 0;	
9	SEHT		Rd	if C = 0 and Z = 0 then Rd := 1 else Rd := 0;	
10	SETST		Rd	SETC Rd	if C = 1 then Rd := 1 else Rd := 0;

Set Conditional Instruction (continued)**SETxx**

n	Notation	or	Alternative	Operation
11	SETHE	Rd	SETNC Rd	if C = 0 then Rd := 1 else Rd := 0;
12	SETE		SETZ	if Z = 1 then Rd := 1 else Rd := 0;
13	SETNE		SETNZ	if Z = 0 then Rd := 1 else Rd := 0;
14	SETV	Rd		if V = 1 then Rd := 1 else Rd := 0;
15	SETNV	Rd		if V = 0 then Rd := 1 else Rd := 0;
16	Reserved			
17	Reserved			
18	SET1M	Rd		Rd := -1;
19	Reserved			
20	SETLEM	Rd		if N = 1 or Z = 1 then Rd := -1 else Rd := 0;
21	SETGTM	Rd		if N = 0 and Z = 0 then Rd := -1 else Rd := 0;
22	SETLTM	Rd	SETNM Rd	if N = 1 then Rd := -1 else Rd := 0;
23	SETGEM	Rd	SETNNM Rd	if N = 0 then Rd := -1 else Rd := 0;
24	SETSEM	Rd		if C = 1 or Z = 1 then Rd := -1 else Rd := 0;
25	SEHTM	Rd		if C = 0 and Z = 0 then Rd := -1 else Rd := 0;
26	SETSTM	Rd	SETCM Rd	if C = 1 then Rd := -1 else Rd := 0;
27	SETHEM	Rd	SETNCM Rd	if C = 0 then Rd := -1 else Rd := 0;
28	SETEM		SETZM	if Z = 1 then Rd := -1 else Rd := 0;
29	SETNEM		SETNZM	if Z = 0 then Rd := -1 else Rd := 0;
30	SETVM	Rd		if V = 1 then Rd := -1 else Rd := 0;
31	SETNVM	Rd		if V = 0 then Rd := -1 else Rd := 0;

Exceptions:

None.

Store (absolute address mode)**ST_{xx}.A**

Format:

RRdis format

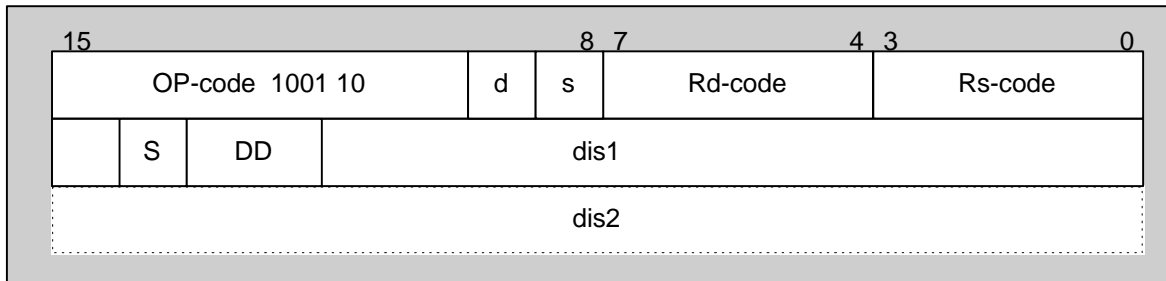

s = 0: Rs-code encodes G0..G15 for Rs, s = 1: Rs-code encodes L0..L15 for Rs

d = 0: Rd-code encodes G0..G15 for Rd, d = 1: Rd-code encodes L0..L15 for Rd

S : Sign bit of dis, e = 0: dis = 20S // dis1(range -4,096..4,095)

e = 1: dis = 4S // dis1 // dis2 (range -268,435,456...268,435,455)

DD: D-code, D13..D12 encode data types at memory instructions

Notation:

ST_{xx}.A 0, Rs, dis

Description:

The Store instruction of absolute address mode transfers data from a register Rs or a register pair Rs//Rsf into the addressed memory location, displacement dis is used as an address.

The displacement dis is used as an address into memory address space. Rd must denote the SR to differentiate this mode from the displacement address mode; the content of the SR is not used.

Data type xx is with

BU: Byte unsigned HU: Halfword unsigned W: Word

BS: Byte signed HS: Halfword signed D: Double-word

Operation:

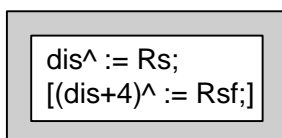

Exceptions:

None.

Store Double Word (post-increment address mode)**STD.P**

Format:

LR format

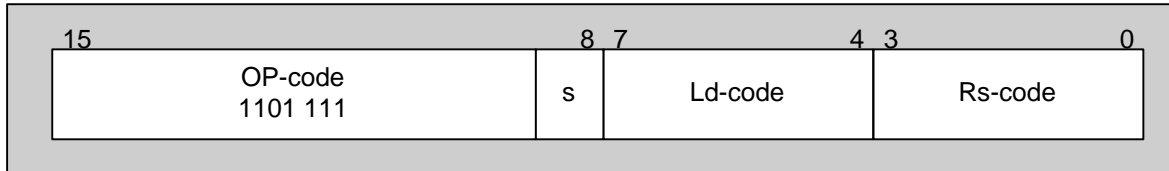

s = 0: Rs-code encodes G0..G15 for Rs

s = 1: Rs-code encodes L0..L15 for Rs

Ld-code encodes L0..L15 for Ld

Notation:

STD.P Ld, Rs

Description:

The Store instruction of post-increment address mode transfers data from a register pair Rs/Rsf into the addressed memory location, Ld is used as an address.

The content of the destination register Ld is used as an address into memory address space, then Ld is incremented according to the specified data size of double-word memory instruction by 8, regardless of any exception occurring. Ld is incremented by 8 at the first memory cycle.

Operation:

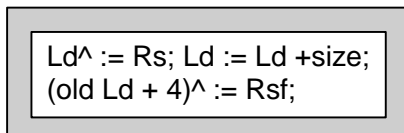

Exceptions:

None.

Store Double Word (register address mode)**STD.R**

Format:

LR format

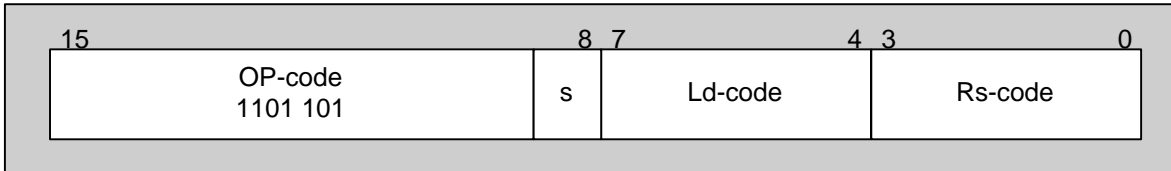

s = 0: Rs-code encodes G0..G15 for Rs

s = 1: Rs-code encodes L0..L15 for Rs

Ld-code encodes L0..L15 for Ld

Notation:

STD.R Ld, Rs

Description:

The Store instruction of register address mode transfers data from a register pair Rs//Rsf into the addressed memory location, Ld is used as an address.

The content of the destination register Ld is used as an address into memory address space.

Operation:

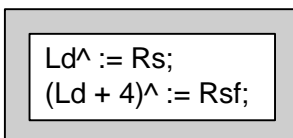

Exceptions:

None.

Store (displacement address mode)**STxx.D**

Format:

RRdis format

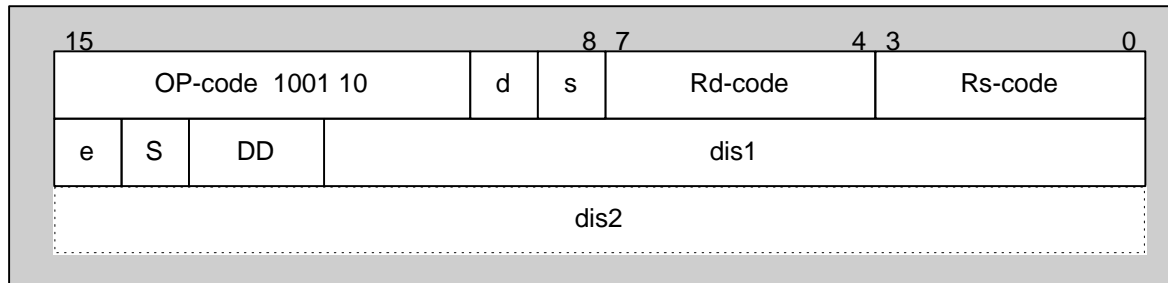

s = 0: Rs-code encodes G0..G15 for Rs, s = 1: Rs-code encodes L0..L15 for Rs

d = 0: Rd-code encodes G0..G15 for Rd, d = 1: Rd-code encodes L0..L15 for Rd

S : Sign bit of dis, e = 0: dis = 20S // dis1(range -4,096..4,095)

e = 1: dis = 4S // dis1 // dis2 (range -268,435,456...268,435,455)

DD: D-code, D13..D12 encode data types at memory instructions

Notation:

STxx.D Rd, Rs, dis

Description:

The Store instruction of displacement address mode transfers data from a register Rs or a register pair Rs//Rsf. into the addressed memory location, Rd plus a signed dis is used as an address.

The sum of the contents of the destination register Rd plus a signed displacement dis is used as an address into memory address space.

Rd may denote any register except the SR; Rd not denoting the SR differentiates this mode from the absolute address mode.

Data type xx is with

BU: Byte unsigned HU: Halfword unsigned W: Word

BS: Byte signed HS: Halfword signed D: Double-word

Operation:

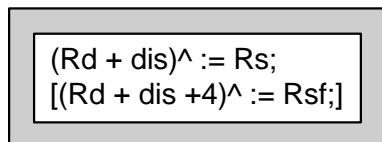

Exceptions:

None.

Store (I/O absolute address mode)**STxx.IOA**

Format:

RRdis format

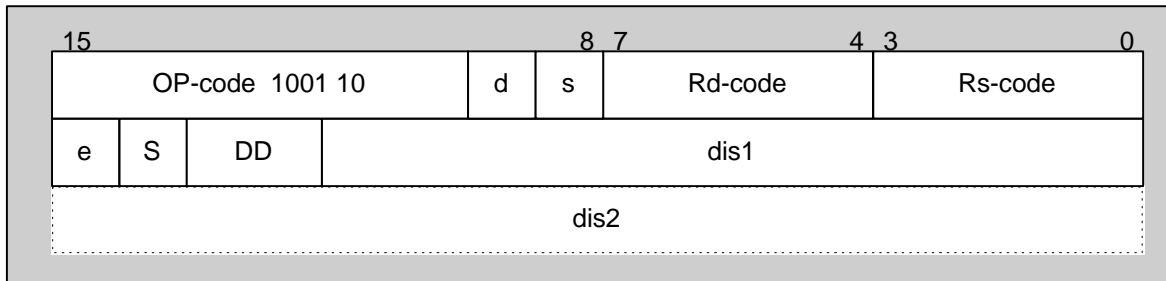

s = 0: Rs-code encodes G0..G15 for Rs, s = 1: Rs-code encodes L0..L15 for Rs

d = 0: Rd-code encodes G0..G15 for Rd, d = 1: Rd-code encodes L0..L15 for Rd

S : Sign bit of dis, e = 0: dis = 20S // dis1(range -4,096..4,095)

e = 1: dis = 4S // dis1 // dis2 (range -268,435,456...268,435,455)

DD: D-code, D13..D12 encode data types at memory instructions

Notation:

STxx.IOA 0, Rs, dis

Description:

The Store instruction of I/O absolute address mode transfers data from a register Rs or a register pair Rs//Rsf into the addressed memory location, dis is used as an address.

The displacement dis is used as an address into I/O address space.

Rd must denote the SR to differentiate this mode from the I/O displacement address mode; the content of the SR is not used.

Data type xx is with

W: Word

D: Double-word

Operation:

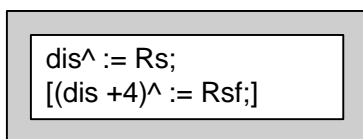

Exceptions:

None.

Store (I/O displacement address mode)**ST_{xx}.IOD**

Format:

RRdis format

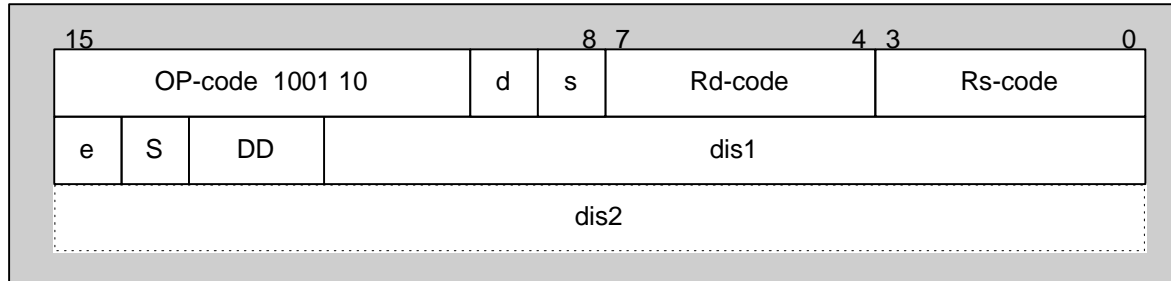

s = 0: Rs-code encodes G0..G15 for Rs, s = 1: Rs-code encodes L0..L15 for Rs

d = 0: Rd-code encodes G0..G15 for Rd, d = 1: Rd-code encodes L0..L15 for Rd

S : Sign bit of dis, e = 0: dis = 20S // dis1(range -4,096..4,095)

e = 1: dis = 4S // dis1 // dis2 (range -268,435,456...268,435,455)

DD: D-code, D13..D12 encode data types at memory instructions

Notation:

ST_{xx}.IOD Rd, Rs, dis

Description:

The Store instruction of I/O displacement address mode transfers data from a register Rs or a register pair Rs//Rsf. into the addressed memory location, Rd plus a signed dis is used as an address.

The sum of the contents of the destination register Rd plus a signed displacement dis is used as an I/O address into memory address space.

Rd may denote any register except the SR; Rd not denoting the SR differentiates this mode from the I/O absolute address mode.

Data type xx is with

W: Word D: Double-word

Operation:

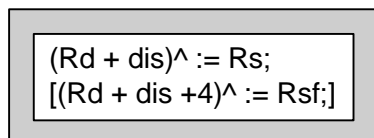

Exceptions:

None.

Store (next address mode)**ST_{xx}.N**

Format:

RRdis format

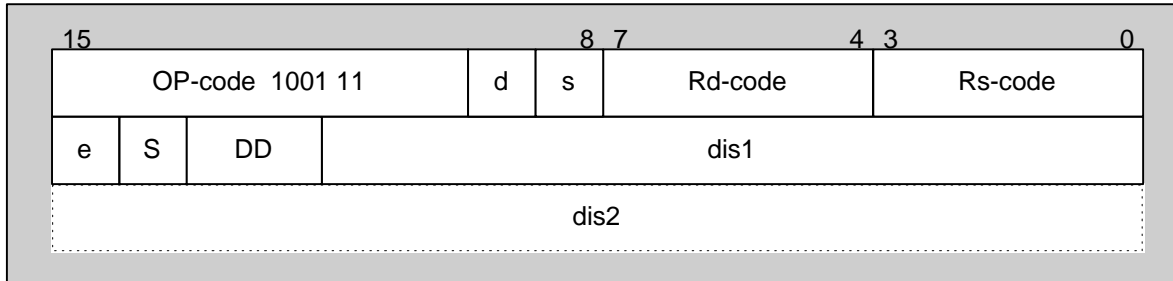

s = 0: Rs-code encodes G0..G15 for Rs, s = 1: Rs-code encodes L0..L15 for Rs
 d = 0: Rd-code encodes G0..G15 for Rd, d = 1: Rd-code encodes L0..L15 for Rd
 S : Sign bit of dis, e = 0: dis = 20S // dis1 (range -4,096..4,095)
 e = 1: dis = 4S // dis1 // dis2 (range -268,435,456...268,435,455)
 DD: D-code, D13..D12 encode data types at memory instructions

Notation:

ST_{xx}.N Rd, Rs, dis

Description:

The Store instruction of next address mode transfers data from a register Rs or a register pair Rs//Rsf into the addressed memory location, Rd is used as an address.

The content of the destination register Rd is used as an address into memory address space, then Rd is incremented by the signed displacement dis regardless of any exception occurring. At a double-word data type, Rd is incremented at the first memory cycle.

Rd must not denote the PC or the SR.

In the case of all data types except byte, bit zero of dis is treated as zero for the calculation of Rd + dis.

Data type xx is with

BU: Byte unsigned HU: Halfword unsigned W: Word

BS: Byte signed HS: Halfword signed D: Double-word

Operation:

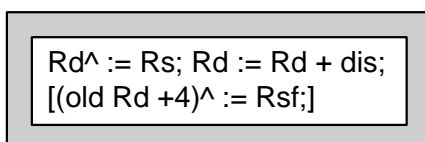

Exceptions:

None.

Store Word (post-increment address mode)**STW.P**

Format:

LR format

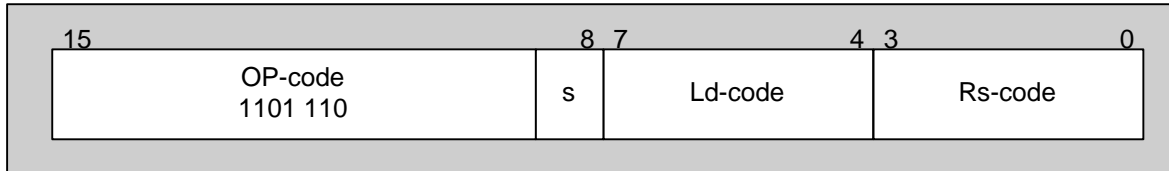

s = 0: Rs-code encodes G0..G15 for Rs

s = 1: Rs-code encodes L0..L15 for Rs

Ld-code encodes L0..L15 for Ld

Notation:

STW.P Ld, Rs

Description:

The Store instruction of post-increment address mode transfers data from a register Rs into the addressed memory location, Ld is used as an address.

The content of the destination register Ld is used as an address into memory address space, then Ld is incremented according to the specified data size of a word by 4, regardless of any exception occurring.

Operation:

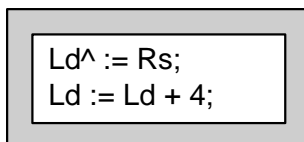

Exceptions:

None.

Store Word (register address mode)**STW.R**

Format:

LR format

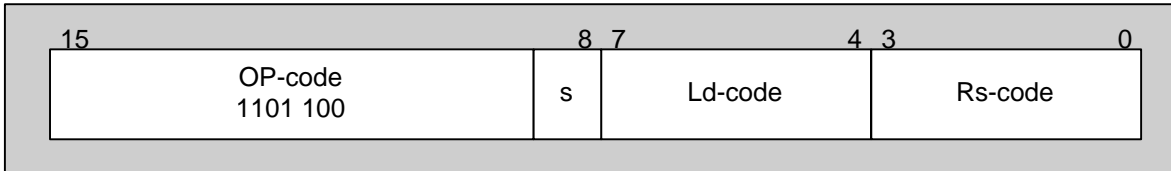

s = 0: Rs-code encodes G0..G15 for Rs

s = 1: Rs-code encodes L0..L15 for Rs

Ld-code encodes L0..L15 for Ld

Notation:

STW.R Ld, Rs

Description:

The Store instruction of register address mode transfers data from into a register Rs into the addressed memory location, Ld is used as an address.

The content of the destination register Ld is used as an address into memory address space.

Operation:

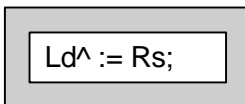

Exceptions:

None.

Store Word (stack address mode)**STW.S**

Format:

RRdis format

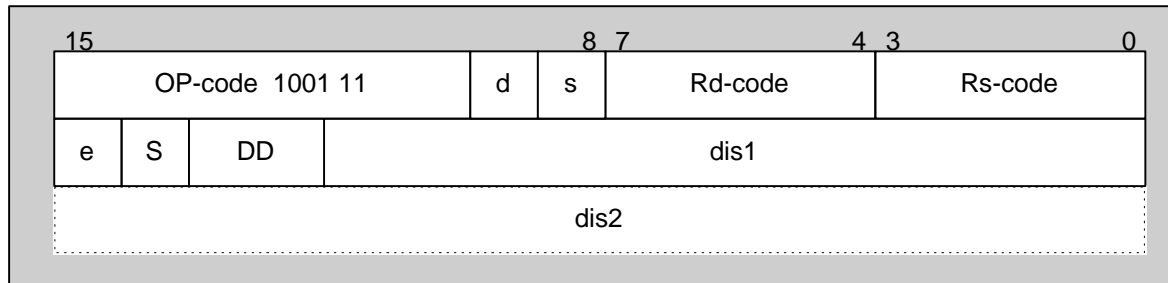

s = 0: Rs-code encodes G0..G15 for Rs, s = 1: Rs-code encodes L0..L15 for Rs

d = 0: Rd-code encodes G0..G15 for Rd, d = 1: Rd-code encodes L0..L15 for Rd

S : Sign bit of dis, e = 0: dis = 20S // dis1(range -4,096..4,095)

e = 1: dis = 4S // dis1 // dis2 (range -268,435,456...268,435,455)

DD: D-code, D13..D12 encode data types at memory instructions

Notation:

STW.S Rd, Rs, dis

Description:

The Store instruction of stack address mode transfers data from into a register Rs into the addressed memory location, Ld is used as an address.

The content of the destination register Rd is used as stack address, then Rd is incremented by dis regardless of any exception occurred.

Operation:

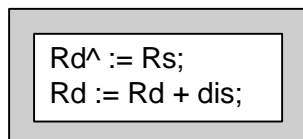

Exceptions:

None.

Subtract**SUB**

Format:

RR format

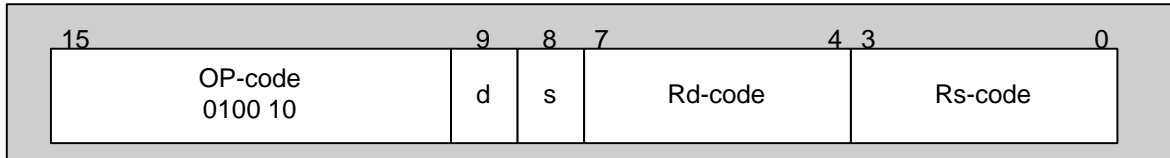

s = 0: Rs-code encodes G0..G15 for Rs
s = 1: Rs-code encodes L0..L15 for Rs
d = 0: Rd-code encodes G0..G15 for Rd
d = 1: Rd-code encodes L0..L15 for Rd

Notation:

SUB Rd, Rs

SUB Rd, C (When SR is denoted as a source operand)

Description:

The source operand is subtracted from the destination operand, the result is placed in the destination register and the condition flags are set or cleared accordingly.

Both operands and the result are interpreted as either all signed or all unsigned integers.

When the SR is denoted as a source operand, C is subtracted instead of the SR.

Operation:

<p>When Rs does not denote SR</p> <p>Rd := Rd - Rs; Z := Rd = 0; N := Rd(31); V := overflow; C := borrow;</p>	<p>When Rs denotes SR</p> <p>Rd := Rd - C; Z := Rd = 0; N := Rd(31); V := overflow; C := borrow;</p>
---	--

Exceptions:

None.

Subtract with Borrow**SUBC**

Format:

RR format

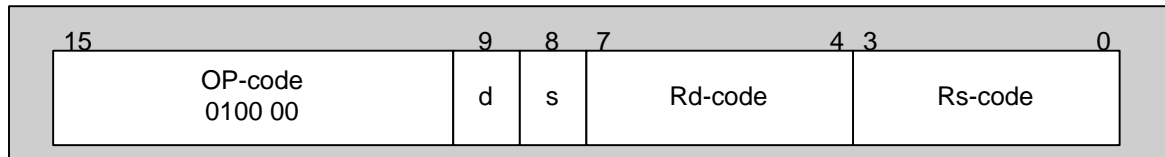

s = 0: Rs-code encodes G0..G15 for Rs

s = 1: Rs-code encodes L0..L15 for Rs

d = 0: Rd-code encodes G0..G15 for Rd

d = 1: Rd-code encodes L0..L15 for Rd

Notation:

SUBC Rd, Rs

SUBC Rd, C (When SR is denoted as a source operand)

Description:

The source operand + C is subtracted from the destination operand, the result is placed in the destination register and the condition flags are set or cleared accordingly.

Both operands and the result are interpreted as either all signed or all unsigned integers.

When the SR is denoted as a source operand, C is subtracted instead of the SR.

Operation:

<p style="text-align: center;">When Rs does not denote SR</p> <p>Rd := Rd - (Rs + C); Z := Z and (Rd = 0); N := Rd(31); V := overflow; C := borrow;</p>	<p style="text-align: center;">When Rs denotes SR</p> <p>Rd := Rd - C; Z := Z and (Rd = 0); N := Rd(31); V := overflow; C := borrow;</p>
---	--

Exceptions:

None.

Signed Subtract with Trap**SUBS**

Format:

RR format

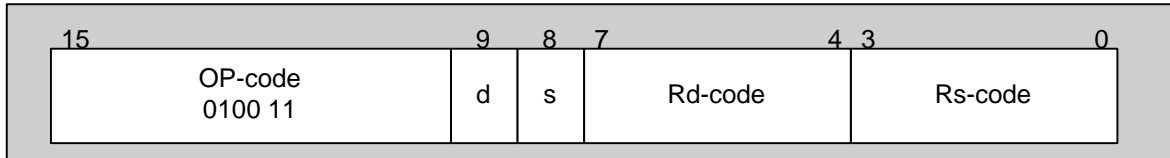

s = 0: Rs-code encodes G0..G15 for Rs
s = 1: Rs-code encodes L0..L15 for Rs
d = 0: Rd-code encodes G0..G15 for Rd
d = 1: Rd-code encodes L0..L15 for Rd

Notation:

SUBS Rd, Rs

SUBS Rd, C (When SR is denoted as a source operand)

Description:

The source operand is subtracted from the destination operand, the result is placed in the destination register and the condition flags are set or cleared accordingly.

Both operands and the result are interpreted as all signed integers and a trap to Range Error occurs at overflow.

When the SR is denoted as a source operand, C is subtracted instead of the SR.

Operation:

<p>When Rs does not denote SR</p> <p>Rd := Rd - Rs Z := Rd = 0; N := Rd(31); V := overflow; If overflow then trap => Range Error</p>	<p>When Rs denotes SR</p> <p>Rd := Rd - Rs; Z := Rd = 0; N := Rd(31); V := overflow; If overflow then trap => Range Error</p>
--	---

Exceptions:

Overflow (Trap to Range Error).

Sum**SUM**

Format:

RRconst format

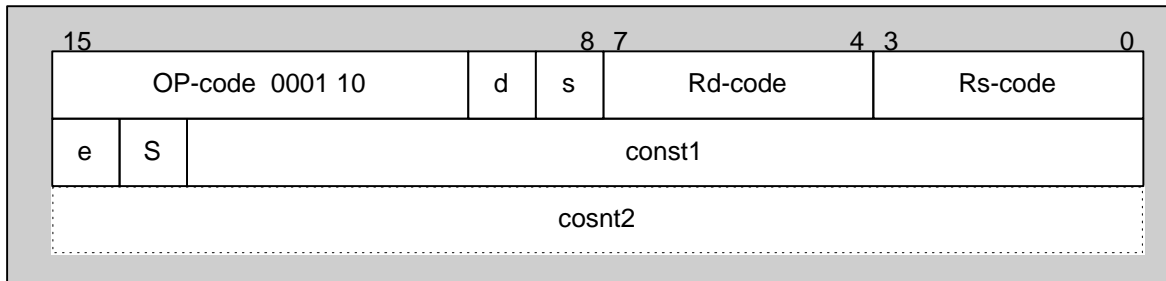

$s = 0$: Rs-code encodes G0..G15 for Rs, $s = 1$: Rs-code encodes L0..L15 for Rs
 $d = 0$: Rd-code encodes G0..G15 for Rd, $d = 1$: Rd-code encodes L0..L15 for Rd
 S : Sign bit of dis, $e = 0$: $\text{const} = 18S // \text{const1}$ (range -16,384..16,383)
 $e = 1$: $\text{const} = 2S // \text{const1} // \text{const2}$ (range -1,073,741,824...1,073,741,823)

Notation:

SUM Rd, Rs, const

SUM Rd, C, const (When SR is denoted as a source operand)

Description:

The sum of the source operand is placed in the destination register and the condition flags are set or cleared accordingly.

Both operands and the result are interpreted as either all signed or all unsigned integers.

When the SR is denoted as a source operand, C is added instead of the SR.

Operation:

When Rs does not denote SR $Rd := Rs + \text{const};$ $Z := Rd = 0;$ $N := Rd(31);$ $V := \text{overflow};$ $C := \text{carry};$	When Rs denotes SR $Rd := C + \text{const};$ $Z := Rd = 0;$ $N := Rd(31);$ $V := \text{overflow};$ $C := \text{carry};$
---	--

Exceptions:

None.

Signed Sum with Trap

SUMS

Format:

RRconst format

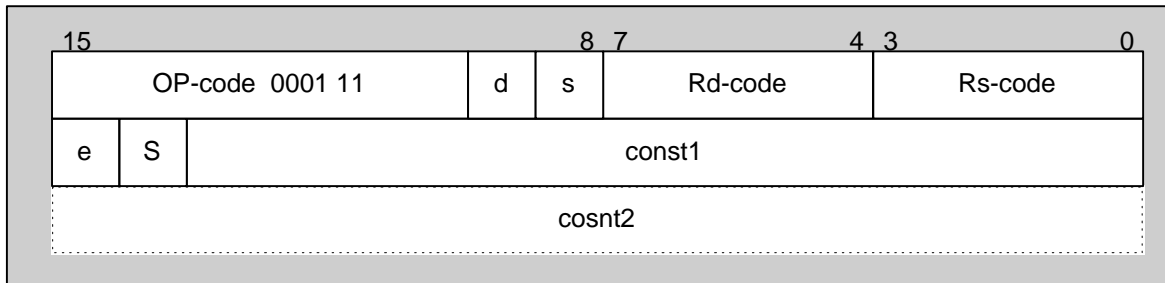

s = 0: Rs-code encodes G0..G15 for Rs, s = 1: Rs-code encodes L0..L15 for Rs
 d = 0: Rd-code encodes G0..G15 for Rd, d = 1: Rd-code encodes L0..L15 for Rd
 S : Sign bit of dis, e = 0: const = 18S // const1 (range -16,384..16,383)
 e = 1: const = 2S // const1 // const2 (range -1,073,741,824...1,073,741,823)

Notation:

SUMS Rd, Rs, const

SUMS Rd, C, const (When SR is denoted as a source operand)

Description:

The sum of the source operand is placed in the destination register and the condition flags are set or cleared accordingly.

Both operands and the result are interpreted as all signed integers and a trap to Range Error occurs at overflow.

When the SR is denoted as a source operand, C is added instead of the SR.

Operation:

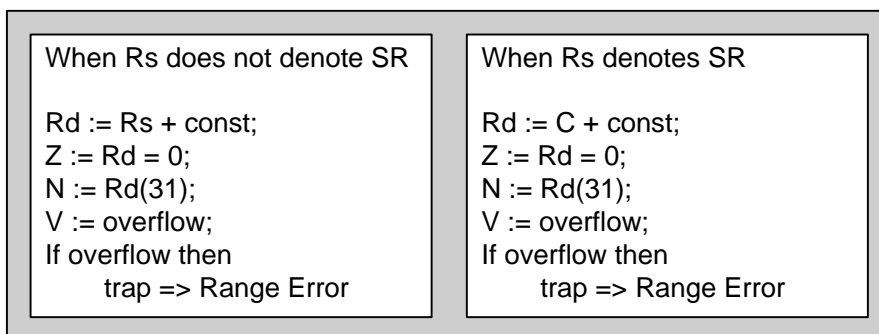

Exceptions:

Overflow (Trap to Range Error).

Test Leading Zeros

TESTLZ

Format:

LL format

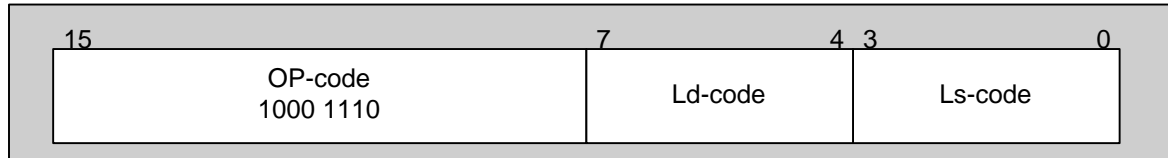

Ls-code encodes L0..L15 for Ls
Ld-code encodes L0..L15 for Ld

Notation:

TESTLZ Ld, Ls

Description:

The number of leading zeros in the source operand is tested and placed in the destination register. A source operand equal to zero yields 32 as a result. All condition flags remain unchanged.

Operation:

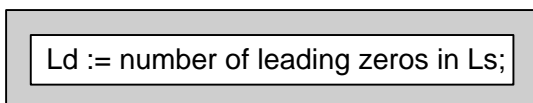

Exceptions:

None.

Trap**TRAP_{xx}**

Format:

PCAdr format

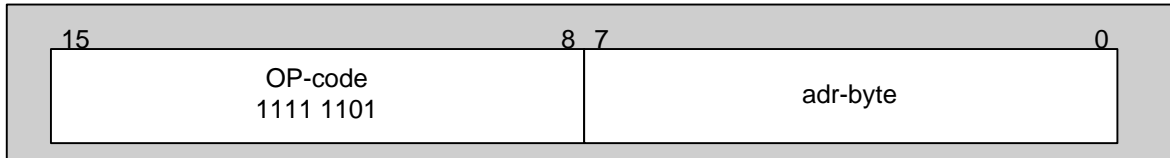

$\text{adr} = 24 \text{ ones's } // \text{adr-byte}(7..2) // 00;$

Notation:

TRAP_{xx} trapno

Description:

The Trap instructions TRAP and any of the conditional Trap instructions when the trap condition is met, cause a branch to one out of 64 supervisor subprogram entries (see [section 2.4. Entry Tables](#)).

When the trap condition is not met, instruction execution proceeds sequentially.

When the subprogram branch is taken, the subprogram entry address *adr* is placed in the program counter PC and the supervisor-state flag *S* is set to one. The old PC containing the return address is saved in the register addressed by $FP + FL$; the old *S* flag is also saved in bit zero of this register. The old status register *SR* is saved in the register addressed by $FP + FL + 1$ ($FL = 0$ is interpreted as $FL = 16$); the saved instruction-length code *ILC* contains the length (1) of the Trap instruction.

Then the frame pointer *FP* is incremented by the old frame length *FL* and *FL* is set to six, thus creating a new stack frame. The cache-mode flag *M* and the trace-mode flag *T* are cleared, the interrupt-lock flag *L* is set to one. All condition flags remain unchanged. Then instruction execution proceeds at the entry address placed in the PC.

The trap instructions are differentiated by the 12 code values given by the bits 9 and 8 of the OP-code and bits 1 and 0 of the adr-byte ($\text{code} = \text{OP}(9..8) // \text{adr-byte}(1..0)$). Since $\text{OP}(9..8) = 0$ does not denote Trap instructions (the code is occupied by the BR instruction), trap codes 0..3 are not available.

Trap (continued)**TRAPxx**

Operation:

Code	Notation	Operation
4	TRAPLE trapno	if N = 1 or Z = 1 then execute TRAP else execute next instruction;
5	TRAPGT trapno	if N = 0 and Z = 0 then execute TRAP else execute next instruction;
6	TRAPLT trapno	if N = 1 then execute TRAP else execute next instruction;
7	TRAPGE trapno	if N = 0 then execute TRAP else execute next instruction;
8	TRAPSE trapno	if C = 1 or Z = 1 then execute TRAP else execute next instruction;
9	TRAPHT trapno	if C = 0 and Z = 0 then execute TRAP else execute next instruction;
10	TRAPST trapno	if C = 1 then execute TRAP else execute next instruction;
11	TRAPHE trapno	if C = 0 then execute TRAP else execute next instruction;
12	TRAPE trapno	if Z = 1 then execute TRAP else execute next instruction;
13	TRAPNE trapno	if Z = 0 then execute TRAP else execute next instruction;
14	TRAPV trapno	if V = 1 then execute TRAP else execute next instruction;
15	TRAP trapno	PC := adr; S := 1; (FP + FL)^ := old PC(31..1)//old S; (FP + FL + 1)^ := old SR; FP := FP + FL; -- FL = 0 is treated as FL = 16 FL := 6; M := 0; T := 0; L := 1;

trapno indicates one of the traps 0..63.

Exceptions:

None.

Index Move

XMx

Format:

RRlim format

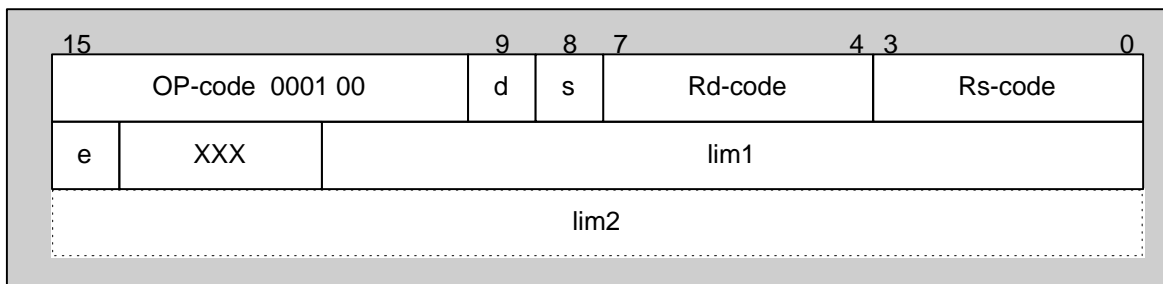

s = 0: Rs-code encodes G0..G15 for Rs, s = 1: Rs-code encodes L0..L15 for Rs
d = 0: Rd-code encodes G0..G15 for Rd, d = 1: Rd-code encodes L0..L15 for Rd
XXX: X-code, X14..X12 encode index instructions
e = 0: lim = 20 zeros // lim1, range 0..4,095
e = 1: lim = 4 zeros // lim1 // lim2, range 0..268,435,455

Notation:

XMx Rd, Rs, imm

XMx Rd, Rs, 0 (Move without flag change)

Description:

The source operand is placed shifted left by 0, 1, 2 or 3 bit positions in the destination register, corresponding to a multiplication by 1, 2, 4 or 8. At XM1..XM4, a trap to Range Error occurs if the source operand is higher than the immediate operand lim (upper bound).

All condition flags remain unchanged. All operands and the result are interpreted as unsigned integers.

The SR must not be denoted as a source or as a destination, nor the PC as a destination operand; these notations are reversed for future expansion. When the PC is denoted as a source operand, a trap to Range Error occurs if $PC \geq \text{lim}$.

Operation:

X-code	Format	Notation	Operation
0	RRlim	XM1 Rd, Rs, lim	Rd := Rs * 1; if Rs > lim then trap ⇒ Range Error;
1	RRlim	XM2 Rd, Rs, lim	Rd := Rs * 2; if Rs > lim then trap ⇒ Range Error;
2	RRlim	XM4 Rd, Rs, lim	Rd := Rs * 4; if Rs > lim then trap ⇒ Range Error;

Index Move (continued)**XMx**

3	RRlim	XM8	Rd, Rs, lim	Rd := Rs * 8; if Rs > lim then trap ⇒ Range Error;
4	RRlim	XX1	Rd, Rs, 0	Rd := Rs * 1; -- Move without flag change
5	RRlim	XX2	Rd, Rs, 0	Rd := Rs * 2;
6	RRlim	XX4	Rd, Rs, 0	Rd := Rs * 4;
7	RRlim	XX8	Rd, Rs, 0	Rd := Rs * 8;

Exceptions:

None.

Exclusive OR**XOR**

Format:

RR format

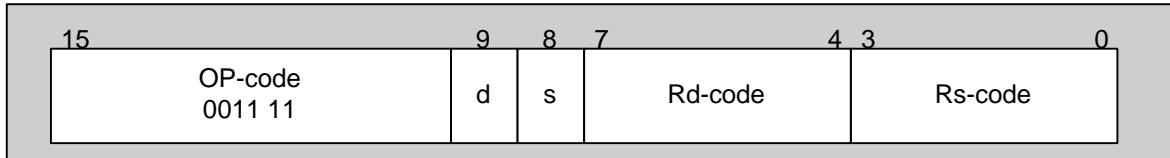

s = 0: Rs-code encodes G0..G15 for Rs
s = 1: Rs-code encodes L0..L15 for Rs
d = 0: Rd-code encodes G0..G15 for Rd
d = 1: Rd-code encodes L0..L15 for Rd

Notation:

XOR Rd, Rs

Description:

The result of a bitwise exclusive OR (XOR) of the source operand (Rs) and the destination operand (Rd) is placed in the destination register (Rd) and the Z flag is set or cleared accordingly.

All operands and the results are interpreted as bit-stings of 32bits each.

Operation:

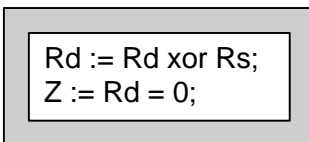

Exceptions:

None.

Exclusive OR Immediate**XORI**

Format:

Rimm format

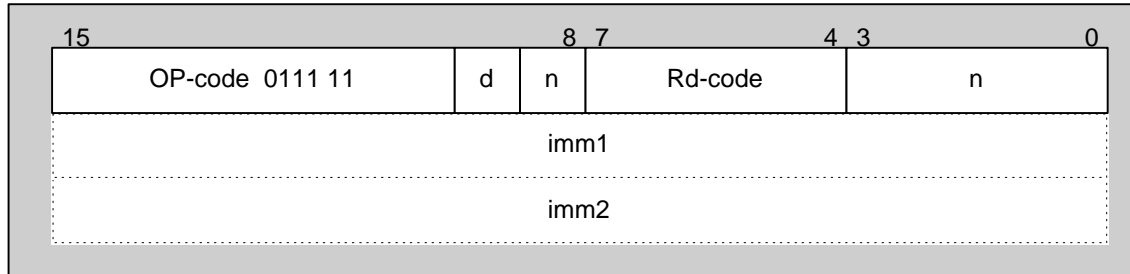

d = 0: Rd-code encodes G0..G15 for Rd, d = 1: Rd-code encodes L0..L15 for Rd

n: Bit 8 // bits 3..0 encode n = 0..31, see Table 2.3 Encoding of Immediate Values for encoding of imm

Notation:

XORI Rd, imm

Description:

The result of a bitwise exclusive OR (XOR) of the immediate operand (imm) and the destination operand (Rd) is placed in the destination register (Rd) and the Z flag is set or cleared accordingly.

All operands and the results are interpreted as bit-stings of 32bits each.

Operation:

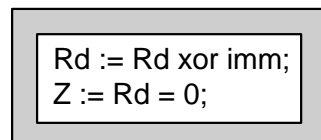

Exceptions:None.