

1. CONFIGURATION & DIMENSIONS :

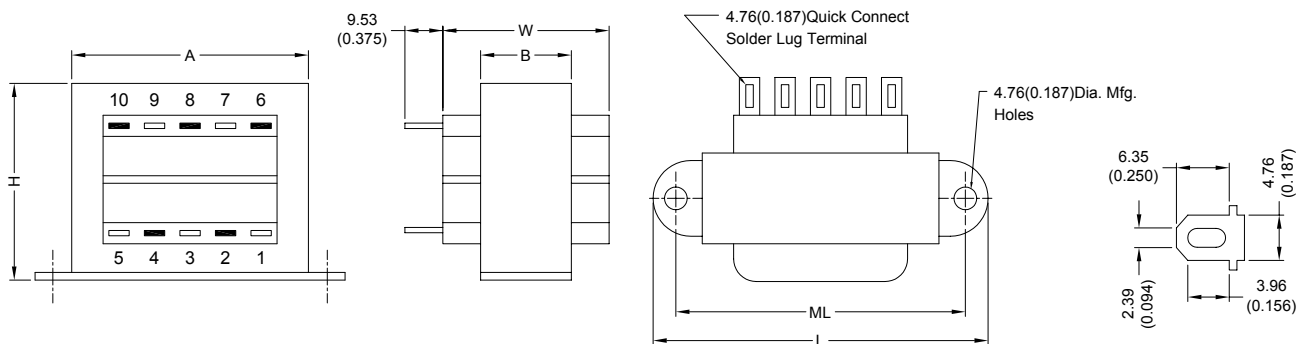

UNIT : mm (inch)

SIZE	VA	L	W	H	A	B	ML	gram
7	56	93.68 (3.688)	46.05 (1.813)	57.15 (2.250)	68.28 (2.688)	27.00 (1.063)	79.38 (3.125)	771.11

2. SCHEMATIC :

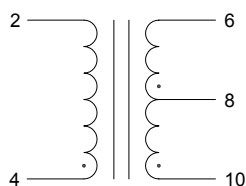

" . " indicates polarity

3. ELECTRICAL CHARACTERISTICS (@ 25°C) :

- | | |
|--------------------------------------|------------------------------|
| a. Primary Voltage | AC 115 V 60 Hz . |
| b. No Load Primary Current | Less Than 30mA . |
| c. Secondary Voltage (±5%) | |
| Pin 6-10 C.T. Pin 8 | AC 11.60 V . |
| d. Secondary Load Current | 5.00A . |
| e. Full Load Primary Current | Less Than 620mA . |
| f. Full Load Secondary Voltage (±5%) | 10.00V . |
| Pin 6-10 C.T. Pin 8 | |
| g. DC Resistance | |
| Pin 2-4 | Primary = 10.50 Ohm . |
| Pin 6-8 | Secondary-1 = 0.06 Ohm . |
| Pin 8-10 | Secondary-2 = 0.07 Ohm . |
| h. Insulation Resistance | DC 500V 100Meg Ohm Of More . |
| i. Withstand Voltage (Hi-Pot) | AC 2500V 60Hz 1 Minutes . |
| j. Temperature Rise | Less Than 60 Deg C . |
| k. Core Size | EI-66 x 26.00 m/m . |

l. Turns & Wire Gauge

- | | | | | |
|-----------|------------|---------|----------------|---------|
| Primary | Pin 2-4 | 585 | Turns Diameter | 0.40 mm |
| Secondary | Pin 6-8-10 | 0-30-60 | Turns Diameter | 1.20 mm |



RoHS Compliant

NOTE : Specifications subject to change without notice. Please check our website for latest information.

25.02.2008



SUPERWORLD ELECTRONICS (S) PTE LTD