

This drawing involves proprietary design rights of Tyco Electronics Corporation, and all design, manufacture, reproduction, use and sale rights regarding the same are expressly reserved. It is submitted for a specific purpose and the recipient by accepting this drawing, assumes custody and control and agrees to take reasonable precautions; (a) that this drawing will not be copied and reproduced, in whole or in part, or its contents revealed in any manner, or to any person except to meet the purpose for which it was delivered and (b) that any special features peculiar to this design will not be incorporated in other projects without the expressed written permission of Tyco Electronics Corporation.

REVISIONS			
EC	REV	DESCRIPTION	DATE
CPR	A	NEW RELEASE	2/28/06

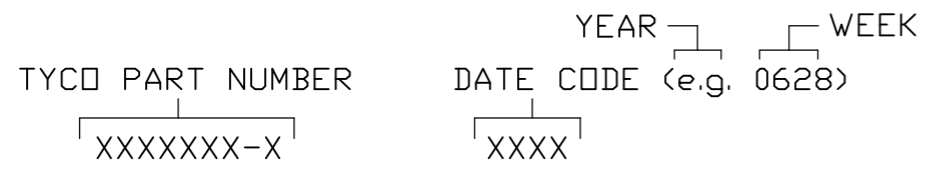

- 7. CONTACTS PURCHASED SEPARATELY.
- 6. ELCON EQUIVALENT SERIES 297-08-01100.
- 5. ITEMS PROVIDED TO THIS SPECIFICATION TO BE PERMANENTLY IDENTIFIED PER THE FOLLOWING IDENTIFIER:



- 4. A REFERENCE DIMENSION (X.XX) IS WITHOUT TOLERANCE AND USED FOR INFORMATION ONLY.
- 3. FINISHES:
RETENTION CLIPS: BRITE DIP PICKLED PER INDUSTRY STANDARDS.
- 2. MATERIALS:
INSULATORS: THERMOPLASTIC, GLASS REINFORCED, UL94V-0 FLAMMABILITY RATED, COLOR-BLACK.
RETENTION CLIPS: COPPER OR STAINLESS STEEL.
- 1. PART NUMBER CHANGES AND OR DESIGN CHANGES AFFECTING ITEM INTERCHANGEABILITY REQUIRE PRIOR TYCO APPROVAL AND AUTHORIZATION BY REVISION TO THIS DRAWING.

NOTES: UNLESS OTHERWISE SPECIFIED

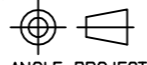
TYCO PART NUMBER
1648203-1

INCH OR INCH (MM)  THIRD ANGLE PROJECTION UNLESS OTHERWISE SPECIFIED DIMENSIONS ARE IN INCHES (METRIC)	DRAWN R. F. A.	DATE 2/28/06	 Tyco Electronics Corporation Menlo Park, Ca 94025 
	CHECKED		
TOLERANCES ANGLES ± .5' DECIMALS .XXX ± .010 (.25) .XX ± .02 (.3)	APPROVED S. FLICKINGER	3/3/06	SIZE DWG NUMBER B C= 1648203
	DCA APPROVED		REV. A
ACAD FILE NUMBER		C1648203A.DWG	DWG SCALE 1=1 SH 1 OF 2

This drawing involves proprietary design rights of Tyco Electronics Corporation, and all design, manufacture, reproduction, use and sale rights regarding the same are expressly reserved. It is submitted for a specific purpose and the recipient by accepting this drawing, assumes custody and control and agrees to take reasonable precautions; (a) that this drawing will not be copied and reproduced, in whole or in part, or its contents revealed in any manner, or to any person except to meet the purpose for which it was delivered and (b) that any special features peculiar to this design will not be incorporated in other projects without the expressed written permission of Tyco Electronics Corporation.

REVISIONS			
EC	REV	DESCRIPTION	DATE
		SEE SHEET 1	

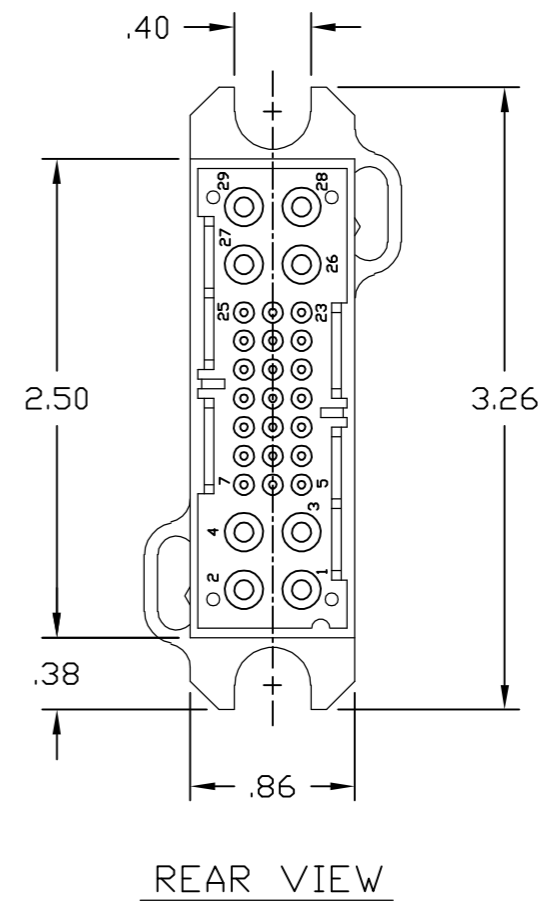
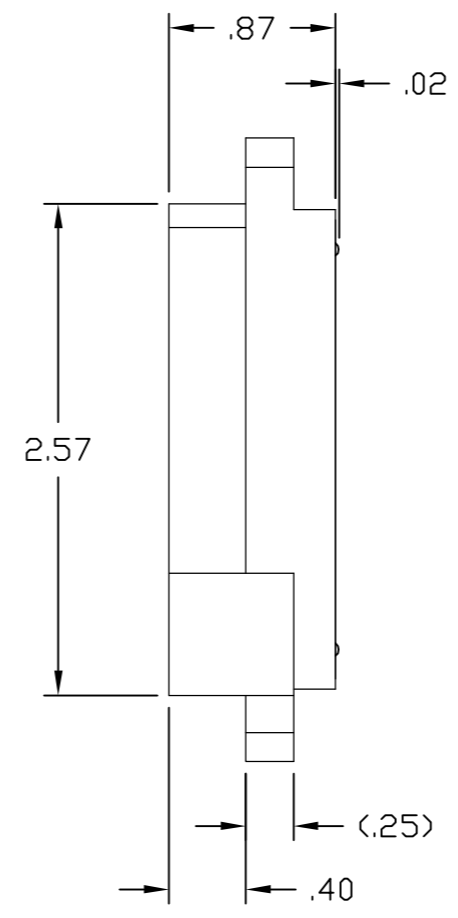
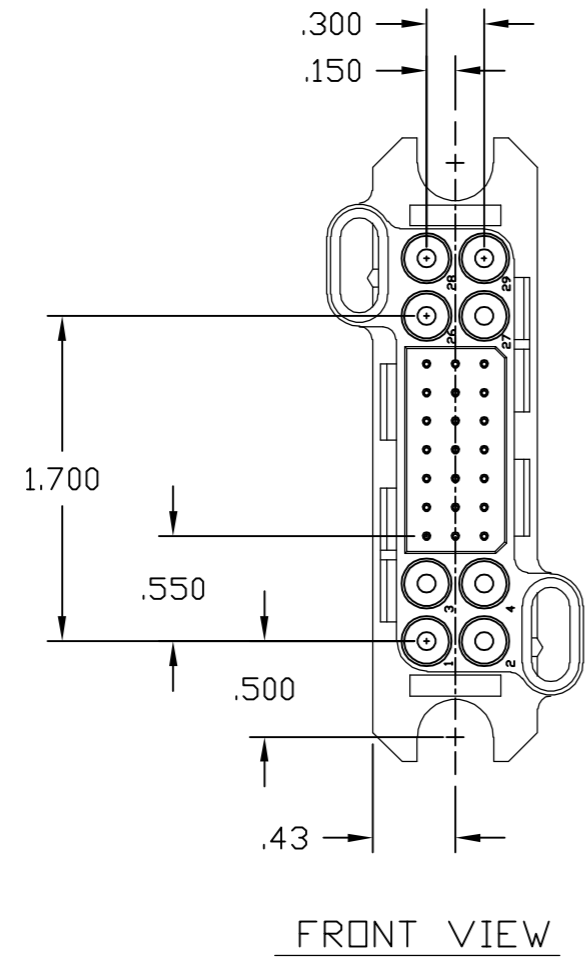

INCH OR INCH (MM) THIRD ANGLE PROJECTION UNLESS OTHERWISE SPECIFIED DIMENSIONS ARE IN INCHES (METRIC) TOLERANCES ANGLES ± .5' DECIMALS .XXX ± .010 (.25) .XX ± .02 (.3)	DRAWN R. F. A.	DATE 2/28/06	tyco Tyco Electronics Corporation Electronics Menlo Park, Ca 94025 ELCON	
	CHECKED			TITLE CONNECTOR, PIN SIZE #12, #20, #12 CONFIG. LOWER DRAWER
	APPROVED		APPROVED S. FLICKINGER	DATE 3/3/06
	APPROVED DCA APPROVED		ACAD FILE NUMBER C1648203A.DWG	SIZE B DWG NUMBER C-1648203 REV. A
			DWG SCALE 1=1	SH 2 OF 2