

SPEC No.	LCP-03022A
FILE No.	
ISSUE :	Oct 16, 2003
PAGE :	25 pages

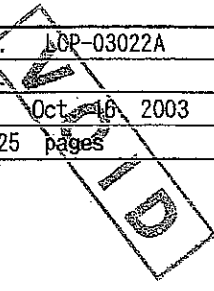

**SPECIFICATION**

DEVICE SPECIFICATION FOR

**CG-Silicon TFT-LCD module**

MODEL No. LS040V7DD92

CUSTOMER'S APPROVAL

DATA \_\_\_\_\_

BY \_\_\_\_\_

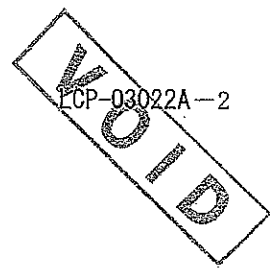

LCP-03022A-2

(1) Application

This literature applies to L S 0 4 0 V 7 D D 9 2

(2) Overview

This module is a color transfective and active matrix LCD module incorporating CG-Silicon TFT (Continuous Grain-Silicon Thin Film Transistor), named AD-TFT (Advanced TFT). It is composed of a color TFT-LCD panel, driver ICs, an FPC, a back light, a touch panel and a back sealed casing. It isn't composed control circuit. Graphics and texts can be displayed on a 480×3×640 dots panel with 262,144 colors by supplying.

This LCD module has multi resolution and multi colors functions. A resolution mode is selective in VGA (480H×640V) or QVGA(240H×320V). A Color mode is selective in 262,144 colors (18bit RGB) or 8 colors (3bit RGB).

Optimum view angle is 6 o'clock. An inverted display mode is selective in the vertical and the horizontal direction.

(3) Mechanical specifications

Table 1

Parameter	Specifications	Units	Remarks
Screen size (Diagonal)	10.0 [4.0" ] Diagonal	cm	
Display active area	60.48 (H) × 80.64 (V)	mm	
Touch panel active area	61.50×81.60	mm	
Pixel format	480(H)×640(V) (1 pixel = R+G+B dots)	pixels	
Pixel pitch	0.042 (H) × 0.126 (V)	mm	
Pixel configuration	R,G,B vertical stripe		
Unit outline dimension	69.3(W)×96.0(H)×4.2(D)	mm	[Note3-1]
Mass	Typ.57, Max.62	g	
Surface hardness (Touch panel)	3H		

[Note 3-1]

Excluding protrusion. For detailed measurements and tolerances, please refer to Fig. 1.

(4) Pixel configuration

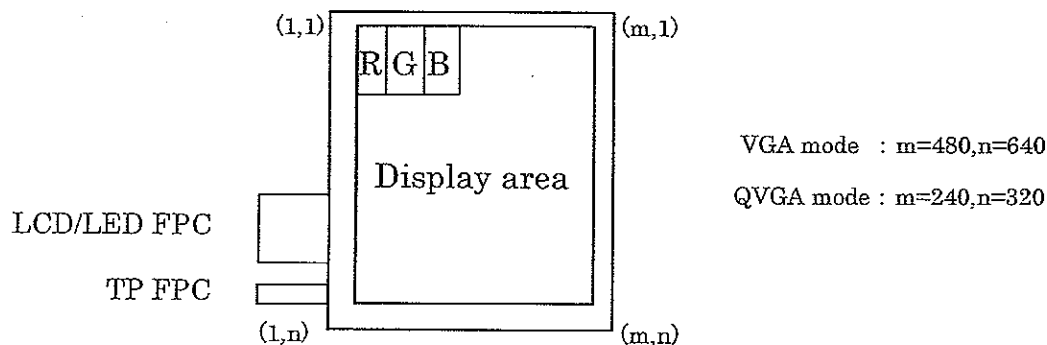

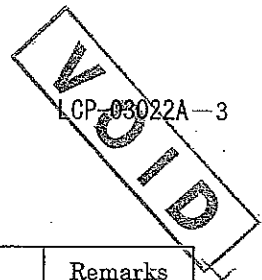

(5)Input/Output terminal

5-1)TFT-LCD panel and Touch panel driving section

Table2

Pin No.	Symbol	I/O	Description	Remarks
1	GVSS	—	Power supply of driver (low level2)	
2	GND	—	Ground	
3	GND	—	Ground	
4	INI	I	Control signal of driver	[Note5-1]
5	SPS	I	Start signal of gate driver	
6	CLS	I	Clock signal of gate driver	
7	MO	I	Selection for resolution (VGA or QVGA)	[Note5-2]
8	U/L	I	Selection for vertical scanning direction	[Note5-3]
9	R0	I	RED data signal (LSB)	
10	R1	I	RED data signal	
11	R2	I	RED data signal	
12	R3	I	RED data signal	
13	R4	I	RED data signal	
14	R5	I	RED data signal (MSB)	
15	G0	I	GREEN data signal (LSB)	
16	G1	I	GREEN data signal	
17	G2	I	GREEN data signal	
18	G3	I	GREEN data signal	
19	G4	I	GREEN data signal	
20	G5	I	GREEN data signal (MSB)	
21	B0	I	BLUE data signal (LSB)	
22	B1	I	BLUE data signal	
23	B2	I	BLUE data signal	
24	B3	I	BLUE data signal	
25	B4	I	BLUE data signal	
26	B5	I	BLUE data signal (MSB)	
27	VSSD	—	Power supply of driver (low level1)	[Note5-4]
28	GND	—	Ground	
29	DCLK	I	Data sampling clock signal	
30	VSHD	—	Power supply (digital)	[Note5-4]
31	VCOM	I	Common electrode driving signal	
32	VDD	—	Power supply of driver (High level)	[Note5-4]
33	CsCOM	I	Cs electrode driving signal	[Note5-4]
34	VSHA	—	Power supply (analog)	[Note5-4]
35	V4	I	Standard voltage to generate gray scale voltage :option	
36	V3	I	Standard voltage to generate gray scale voltage :option	

Pin No.	Symbol	I/O	Description	Remarks
37	V2	I	Standard voltage to generate gray scale voltage :option	
38	V1	I	Standard voltage to generate gray scale voltage :option	
39	V0	I	Standard voltage to generate gray scale voltage :option	
40	SPL	I/O	Sampling start signal	[Note5-5]
41	SPR	I/O	Sampling start signal	[Note5-5]
42	LP	I	Data latch signal of source driver	
43	CO	I	Selection for color mode (18bit or 1bit digital RGB)	[Note5-6]
44	REV	I	Reverse control signal	
45	COM	O	Produce REV signal with the amplitude of AGND - VSHA :option	
46	LBR	I	Selection for horizontal scanning direction	[Note5-5]
47	ASC	I	Analog switch control signal	
48	SSC	I	Source signal control	
49	GND	-	Ground	
50	LED+	-	Power supply for LED (High voltage)	[Note5-4]
51	LED-	-	Power supply for LED (Low voltage)	

[Note5-1] See section(7-1)-(A) "※Cautions when you turn on or off the power supply".

[Note5-2] Selection for resolution mode

MO	Resolution
High	VGA
Low	QVGA

[Note5-3] Selection for vertical scanning direction

U/L	Scanning direction (Pixel configuration)
High	Conventional scanning (X, 1) ↓ (X, Y)
Low	Inverted scanning (X, 1) ↑ (X, Y)

VGA mode: Y=640, QVGA mode: Y=320

[Note5-4] When superfluous current flows, please intercept current with a fuse etc.

[Note5-5] Selection for horizontal scanning direction

LBR	SPL	SPR	Scanning direction (Pixel configuration)
High	Input	Output	Normal scanning (1,Y) → (X,Y)
Low	Output	Input	Inverted scanning (1,Y) ← (X,Y)

VGA mode: X=480, QVGA mode: X=240

[Note5-6] Selection for color mode

CO	Color variation
High	262,144 colors ( 18bit RGB colors )
Low	8 colors ( 3bit RGB colors )

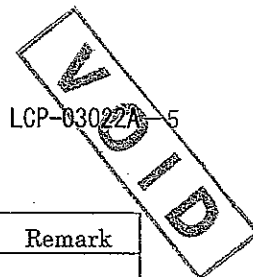

## 5-2) Touch panel driving section

Table 3

Pin No.	Symbol	I/O	Description	Remark
T1	Y1	-	Upper electrode Y (12 o'clock side)	
T2	X1	-	Lower electrode X (Left side)	
T3	Y2	-	Upper electrode Y (6 o'clock side)	
T4	X2	-	Lower electrode X (Right side)	

## (6) Absolute Maximum Ratings

Table 4

Parameter	Symbol	Condition	Ratings	Unit	Remark
Power supply (COG driver / Analog)	VSHA	Ta=25°C	-0.3~+6.0	V	
Power supply (COG driver / Digital)	VSHD	Ta=25°C	-0.3~+4.0	V	
Power supply (monolithic driver)	VDD	Ta=25°C	-0.3~+9.0	V	
Power supply (monolithic driver)	VSSD	Ta=25°C	-5.0~+0.3	V	
Power supply (monolithic driver)	GVSS	Ta=25°C	-9.0~+0.3	V	
Input voltage (Analog)	VIA	Ta=25°C	-0.3~VSHA+0.3		[Terminal①]
Input voltage (Digital)	VID	Ta=25°C	-0.3~VSHD+0.3	V	[Terminal②]
Input voltage (VCOM, CsCOM)	VCOM	Ta=25°C	-2.0~+4.5V	V	
	CsCOM	Ta=25°C	-0.3~+14.0V	V	
Input voltage (Touch panel)	VIT	Ta=25°C	24	V	[Note6-1]
Input current (Touch panel)	IIT	Ta=25°C	90	mA	[Note6-1]
Operating temperature (Panel surface)	T opp	-	-10~60	°C	[Note6-2]
Storage temperature	T stg	-	-20~70	°C	[Note6-2]

[Terminal①] V0~V4

[Terminal②] SSC,ASC,LBR,REV,CO,LP,SPR,SPL,DCLK,R0~R5,G0~G5,B0~B5,U/L,MO,CLS,SPS,INI

[Note6-1] Terminals of touch panel(X1,X2,Y1,Y2) are applied(within 1 minute).

When power supply is over 5V(within 1-minute),please don't touch the touch panel.

If you touch it, some problem may occur.

[Note6-2] Humidity: 95%RH Max.(at Ta ≤ 40°C). Maximum wet-bulb temperature is less than 39°C (at Ta > 40°C). Condensation of dew must be avoided.

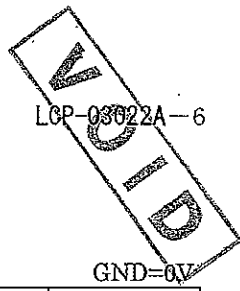

LCP-03022A-6

(7)Electrical characteristics

7-1) Recommended operating conditions

A) TFT-LCD panel driving section

Table 5

GND=0V

Parameter		Symbol	Min.	Typ.	Max.	Unit	Remarks
Supply voltage for COG driver	Analog	VSHA	+4.8	+5.0	+5.2	V	
	Digital	VSHD	+3.0	+3.3	+3.6	V	
Supply voltage for monolithic driver	High voltage	VDD	+7.6	+8.0	+8.4	V	
	Low voltage	VSSD	-4.4	-4.0	-3.6	V	
	Low voltage	GVSS	-8.4	-8.0	-7.6	V	
Gray scale voltage		V0~V4	GND		VSHA	V	[Note 7-1]
Input voltage (Low)		VILS	GND	-	0.2VSHD	V	[Note 7-2]
Input voltage (High)		VIHS	0.8VSHD	-	VSHD	V	[Note 7-2]
Input current (Low)		IILS	-	-	1	μA	[Note 7-2]
Input current (High)		IHS	-	-	1	μA	[Note 7-2]
Common electrode driving signal	AC component	VCOMAC	-	±2.5	±2.6	V <sub>p-p</sub>	[Note 7-3]
	DC component	VCOMDC	+0.1	+1.1	+2.1	V	[Note 7-3]
Cs electrode driving signal	AC component	CsCOMAC	-	5.0	5.2	V <sub>p-p</sub>	[Note 7-4]
	DC component	CsCOMDC	+7.6	+8.0	+8.4	V	[Note 7-4]

※ Cautions when you turn on or off the power supply

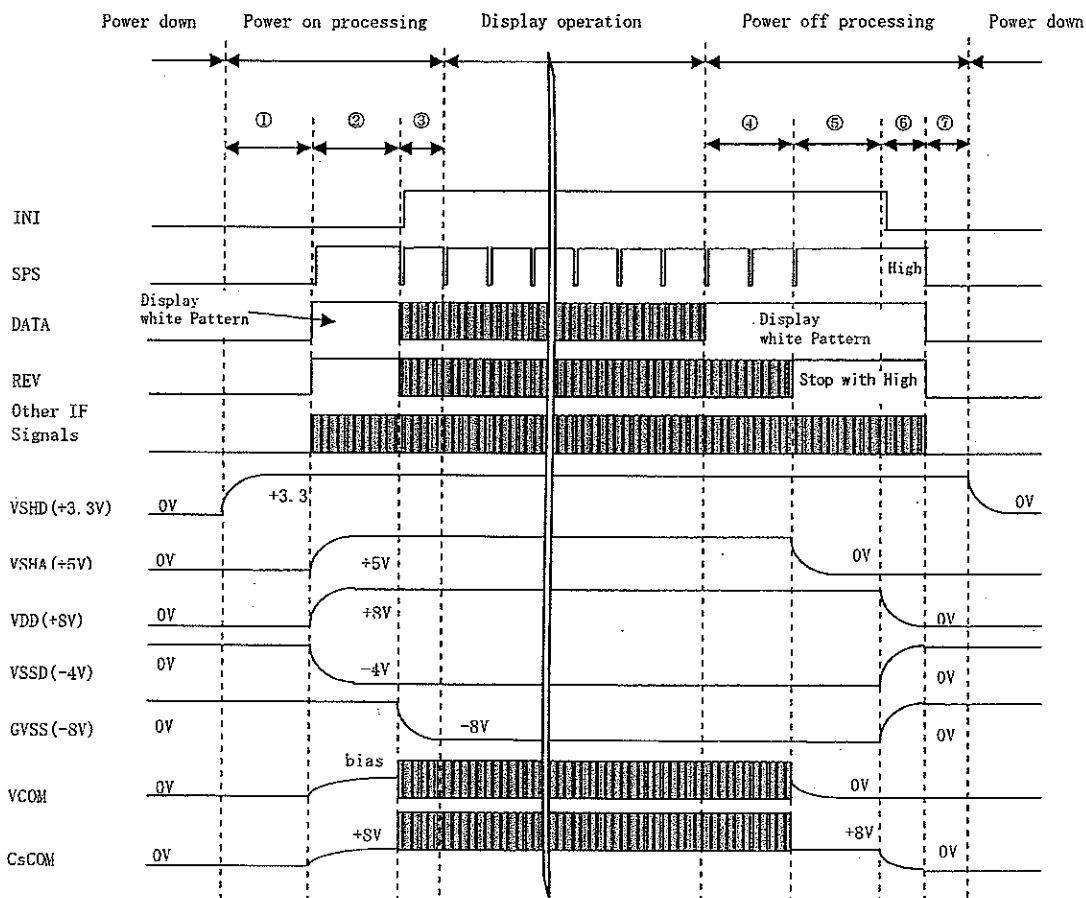

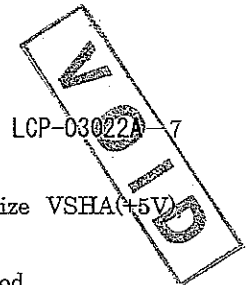

LCP-03022A-7

- ① Stabilize VSHD(3.3V) within double vertical periods second.
- ② Supply SPS, DATA(White pattern), REV(with High), and other signals. Stabilize VSHA(+5V), VDD(+8V), VSSD(-4V) within double vertical periods.
- ③ INI signal and GVSS(-8V) are supplied. Stabilize GVSS(-8V) within single vertical period.
- ④ White pattern is displayed during double or more vertical periods.
- ⑤ REV signal is stopped with High level. VSHA(+5V) supply is stopped, which is stabilized within double vertical periods.
- ⑥ VDD(+8V), VSSD(-4V) and GVSS(-8V) supplies are stopped, which are stabilized within double vertical periods.
- ⑦ SPS, DATA, REV and other IF signals are stopped with Low level. Then VSHD(+3.3V) supply is stopped.

[Note 7-1] These are standard input voltages for gray scale. When VCOM is alternated polarity, these voltage should be alternated polarity. V0(black) is different polarity alternating signal of VCOM. V4(white) is the same polarity alternating signal of VCOM. Center voltage of each standard input voltage shift positive way for LCD characteristics (V0→V1→V2→V3→V4). This shift amount is adjusted so as to no flicker of each standard input voltage after DC bias voltage of VCOM and V0 is adjusted.

[Note 7-2] SSC, ASC, LBR, REV, CO, LP, SPR, SPL, DCLK, U/L, MO, CLS, SPS, INI, R0~R5, G0~G5, B0~B5 terminals are applied.

[Note 7-3] VCOMAC should be alternated on VCOMDC every 1 horizontal period and 1 vertical period. VCOMDC bias is adjusted so as to minimize flicker or maximum contrast every each module.  $VCOM = VCOMAC + VCOMDC$

[Note 7-4] CsCOMAC should be alternated on CsCOMDC every 1 horizontal period and 1 vertical period. CsCOM's phase is as same as VCOM's.  $CsCOM = CsCOMAC + CsCOMDC$

B) Back light driving section

Table 6

Ta=25°C

Parameter	Symbol	MIN	TYP	MAX	Units	Remarks terminal
LED voltage	VL	—	32.4	37.8	V	[Note 7-5]
LED current	IL	—	15.0	20.0	mA	
Power consumption	WL	—	486	—	mW	[Note 7-6]

[Note 7-5] VL(TYP) at IL=15mA. VL(MAX) at IL=20mA.

[Note 7-6] Calculated reference value(IL(TYP)×VL(TYP))

## 7-2) Timing Characteristics of input signals

Table 7 AC Characteristics

(VSHA=+5.0V, VSHD=+3.3V, VDD=+8.0, VSSD=-4V GVSS=-8.0Ta=25°C)

Terminal	Parameter	Symbol	Mode	Min.	Typ.	Max.	Unit
DCK	Clock frequency of source driver	fck	VGA	19.4	—	28	MHz
			QVGA	5.0	—	6.8	
	Rising time of clock	Tcr	—	—	6	ns	
	Falling time of clock	Tcf	—	—	6	ns	
	Pulse width (High level)	Tewh	—	—	—	ns	
	Pulse width (Low level)	Tcwl	—	—	—	ns	
SPL,SPR	Frequency of start pulse	fsp	VGA	35.5	—	39.5	kHz
			QVGA	17.9	—	19.9	
	Rising time of start pulse	Trsp	—	—	10	ns	
	Falling time of start pulse	Tfsp	—	—	10	ns	
	Setup time of start pulse	Tsusp	—	—	10	ns	
	Hold time of start pulse	Thsp	—	—	10	ns	
	Pulse width of start pulse [Note 7-7]	Twsp	—	—	1.5/fck	ns	
LP	Rising time of latch pulse	Trlp	—	—	50	ns	
	Falling time of latch pulse	Tflp	—	—	50	ns	
	Setup time of latch pulse	Tsulp	—	—	100	ns	
	Hold time of latch pulse	Thlp	—	—	50	ns	
	Pulse width of latch pulse	Twlp	—	—	50	ns	
	Phase COM—latch pulse	Tcom-lp	—	—	100	ns	
SSC	Rising time of Source signal control	Trssc	—	—	10	ns	
	Falling time of Source signal control	Tfssc	—	—	10	ns	
	Pulse width of Source signal control	Twssc	—	—	50	ns	
	Pulse period of SSC	Tpssc	VGA	7.3	—	—	μs
			QVGA	14.6	—	—	μs
	Phase of SSC—ASC	Tssc-asc	—	—	0	ns	
R0~R5	Setup time of data	Tsud	—	—	10	ns	
G0~G5	Hold time of data	Thd	—	—	10	ns	
B0~B5			—	—	—	—	
ASC	Rising time of Analog SW control signal	Trasc	—	—	10	ns	
	Falling time of Analog SW control signal	Tfasc	—	—	10	ns	
	Pulse width of Analog SW control signal	Twasc	—	—	50	ns	
	Setup time of Analog SW control signal	Tsuasc	—	—	1	μs	
	Hold time of Analog SW control signal	Thasc	VGA	1.5	—	—	μs
			QVGA	3.0	—	—	μs
	Pulse period of Analog SW control signal	Tpasc1	VGA	5.95	—	—	μs
QVGA			11.9	—	—	μs	
Pulse period of Analog SW control signal	Tpasc2	VGA	1.35	—	—	μs	
			QVGA	2.7	—	—	μs



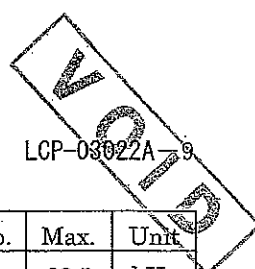

Terminal	Parameter	Symbol		Min.	Typ.	Max.	Unit
CLS	Clock frequency	fcls	VGA	35.5		39.5	kHz
			QVGA	17.9		19.9	
	Rising time of clock	Trcls				50	ns
	Falling time of clock	Tfcls				50	ns
	Setup time of clock	Tsucls		100			ns
	Pulse width of clock (Low1)	Twcls1	VGA	2		4.5	μs
			QVGA	3		9	
	Pulse width of clock (Low2)	Twcls2	VGA	2		4.5	μs
			QVGA	3		9	
	Pulse width of clock(High)	Twclsh	VGA	23			μs
			QVGA	46.1			
Phase SPS-CLS	Tsps-cls1		1			μs	
Phase SPS-CLS	Tsps-cls2		1			μs	
Phase SPS-CLS	Tsps-cls3		1			μs	
Phase SPS-CLS	Tsps-cls4		1			μs	
SPS	Rising time of start pulse	Trsps				50	ns
	Falling time of start pulse	Tfsps				50	ns
	Frequency of start pulse	fsps	VGA	55	60	61.3	Hz
QVGA			55	60	61.6		
VCOM CsCOM	Setup time of VCOM and CsCOM	Tsucom	VGA	2			μs
			QVGA	4			
	Hold time of VOM and CsCOM	Thcom	VGA	1			μs
			QVGA	2			

[Note 7-7] There must be only one up-edge of DCLK (includes Tsusp and Thsp time) in the period SPL (or SPR) = " High

VOID

LCP-03022A-10

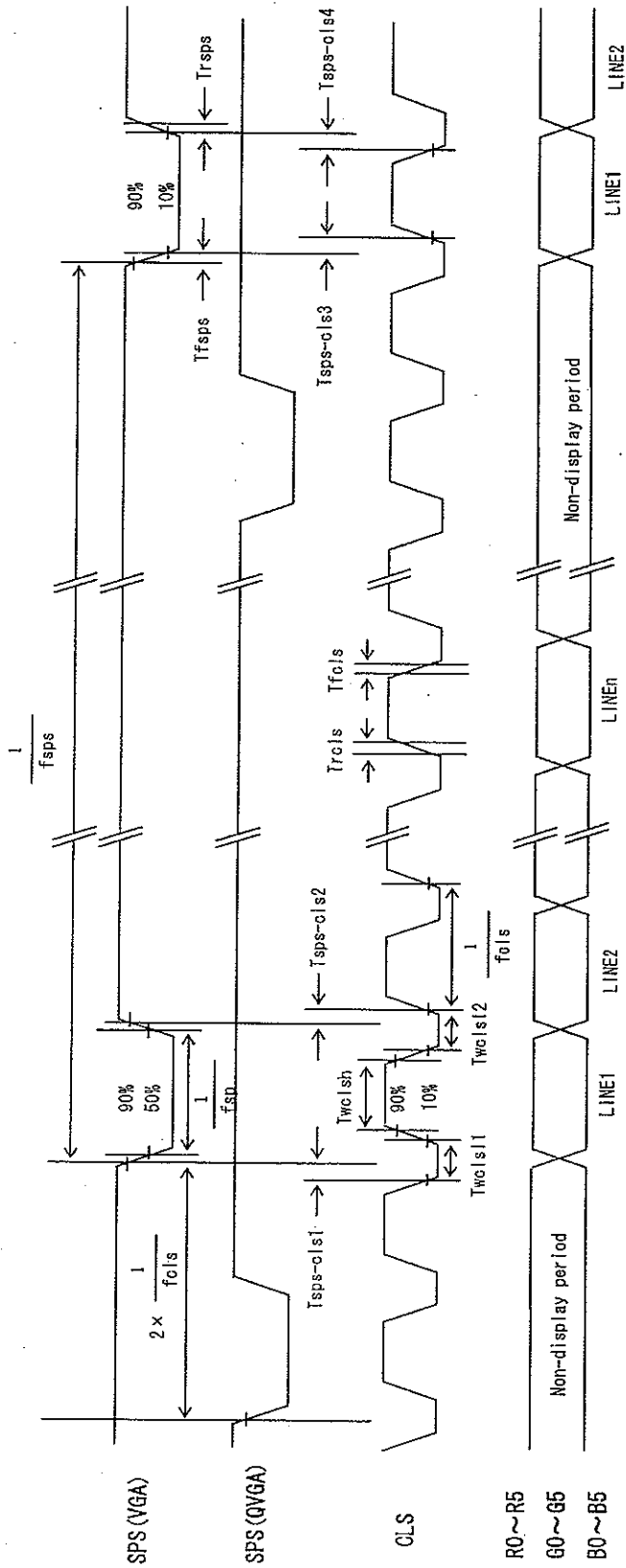

VGA mode : n=640  
 QVGA mode : n=320

Fig.(a) Vertical timing chart

VOID

LOR-03022A-11

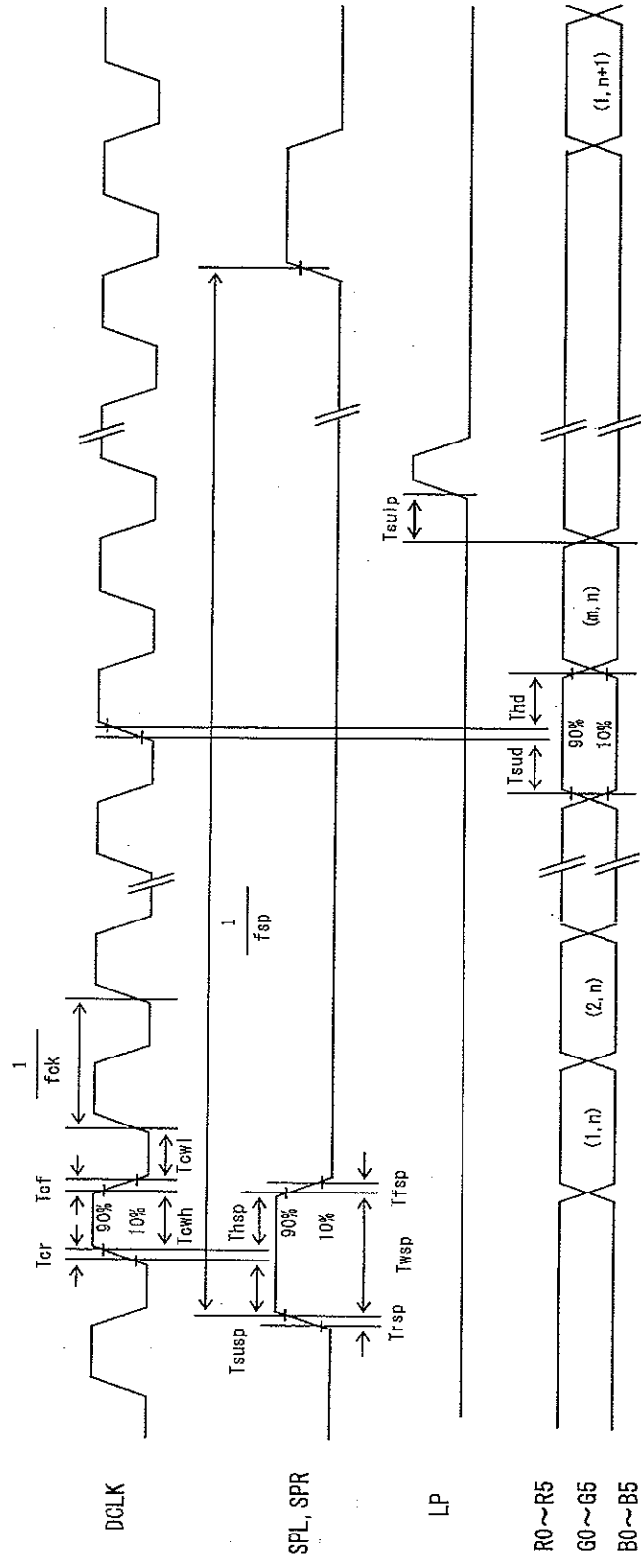

VGA mode : m=480

QVGA mode : m=240

Fig.(b) Horizontal timing chart

VOID

LCP-03022A-12

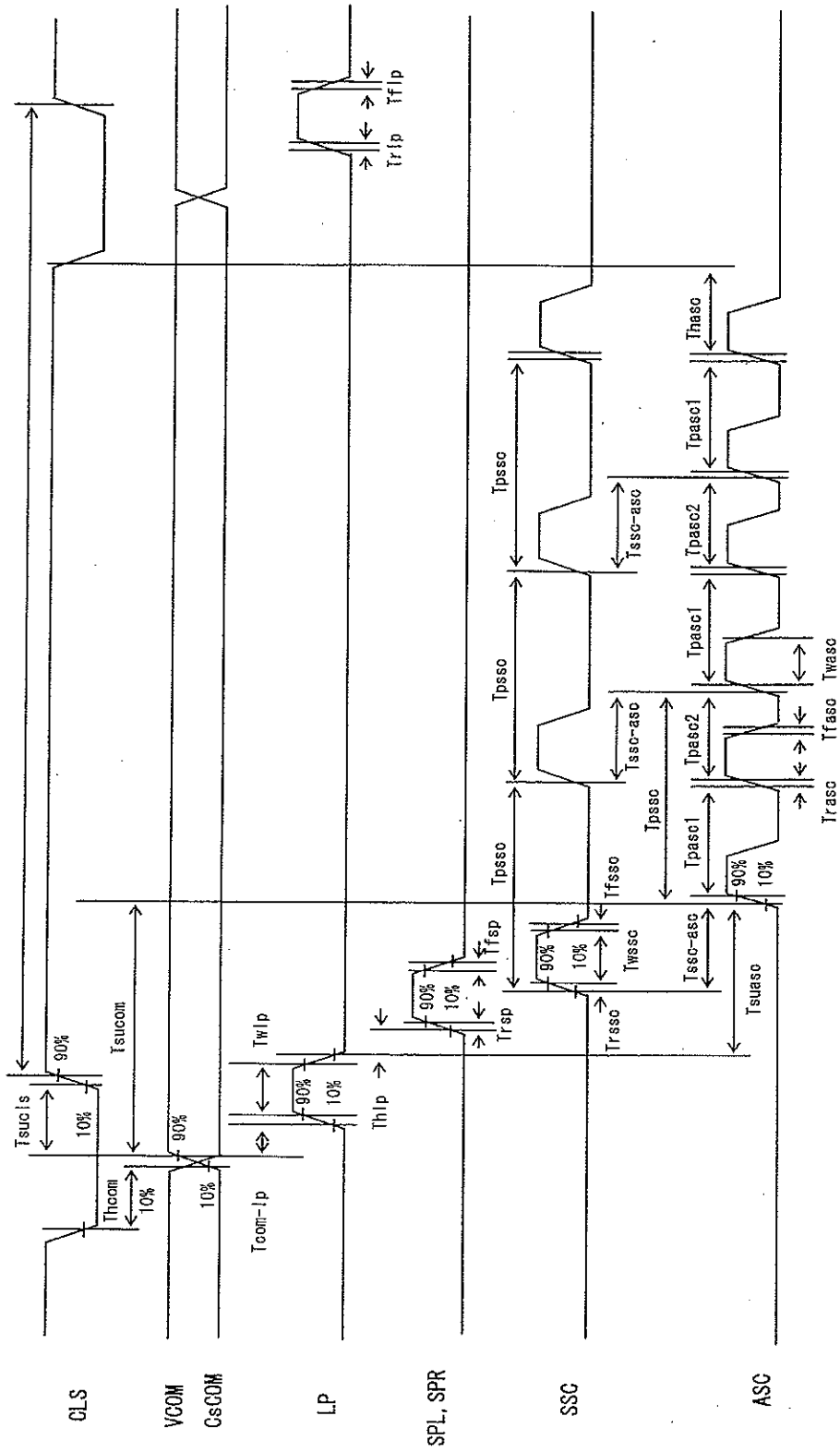

Fig.(c) Horizontal timing chart

## 7-3) Power consumption

Measurement condition : SPS=60Hz, CLS=38.85kHz, SPL=38.85kHz, DCLK=25.175MHz, Ta=25°C

Table 8 when conventional scan mode

Parameter	Sym	Conditions	MIN	TYP	MAX	Unit	Remarks	
COG driver current	Analog	ISHA	VSHA=+5.0V	—	5.5	11.0	mA	[Note7-8]
	Digital	ISHD	VSHD=+3.3V	—	2.3	4.6	mA	[Note7-8]
Monolithic driver current	High	IVDD	VDD=+8.0V	—	0.7	2.0	mA	[Note7-9]
	Low	IVSSD	VSSD=-4.0V	—	-0.6	-1.7	mA	[Note7-9]
	Low	IGVSS	GVSS=-8.0V	—	-0.1	-0.3	mA	[Note7-9]

【Note 7-8】 Vertical stripe pattern alternating 21 gray scale (GS21) with 42 gray scale (GS42) every 1 dot.

【Note 7-9】 64-Gray-bar vertical pattern (GS0 ~ GS63 for horizontal way)

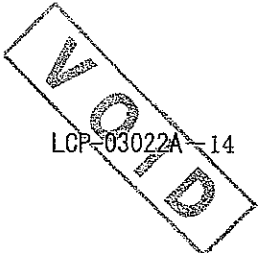

8. Input Signals, Basic Display Color and Gray Scale of Each Color (TBD)

Table 9 18bit RGB color display mode (CO=High)

Colors & Gray scale	Data signal																			
	Gray Scale	R0	R1	R2	R3	R4	R5	G0	G1	G2	G3	G4	G5	B0	B1	B2	B3	B4	B5	
Basic color	Black	—	0	0	0	0	0	0	0	0	0	0	0	0	0	0	0	0	0	0
	Blue	—	0	0	0	0	0	0	0	0	0	0	0	0	1	1	1	1	1	1
	Green	—	0	0	0	0	0	0	1	1	1	1	1	1	0	0	0	0	0	0
	Cyan	—	0	0	0	0	0	0	1	1	1	1	1	1	1	1	1	1	1	1
	Red	—	1	1	1	1	1	1	0	0	0	0	0	0	0	0	0	0	0	0
	Magenta	—	1	1	1	1	1	1	0	0	0	0	0	0	1	1	1	1	1	1
	Yellow	—	1	1	1	1	1	1	1	1	1	1	1	1	0	0	0	0	0	0
	White	—	1	1	1	1	1	1	1	1	1	1	1	1	1	1	1	1	1	1
Gray Scale of red	Black	GS0	0	0	0	0	0	0	0	0	0	0	0	0	0	0	0	0	0	0
	↑	GS1	1	0	0	0	0	0	0	0	0	0	0	0	0	0	0	0	0	0
	Darker	GS2	0	1	0	0	0	0	0	0	0	0	0	0	0	0	0	0	0	0
	↑	↓				↓				↓				↓				↓		
	↓	↓				↓				↓				↓				↓		
	Brighter	GS61	1	0	1	1	1	1	0	0	0	0	0	0	0	0	0	0	0	0
	↓	GS62	0	1	1	1	1	1	0	0	0	0	0	0	0	0	0	0	0	0
	Red	GS63	1	1	1	1	1	1	0	0	0	0	0	0	0	0	0	0	0	0
Gray Scale of green	Black	GS0	0	0	0	0	0	0	0	0	0	0	0	0	0	0	0	0	0	0
	↑	GS1	0	0	0	0	0	0	1	0	0	0	0	0	0	0	0	0	0	0
	Darker	GS2	0	0	0	0	0	0	0	1	0	0	0	0	0	0	0	0	0	0
	↑	↓				↓				↓				↓				↓		
	↓	↓				↓				↓				↓				↓		
	Brighter	GS61	0	0	0	0	0	0	1	0	1	1	1	1	0	0	0	0	0	0
	↓	GS62	0	0	0	0	0	0	0	1	1	1	1	1	0	0	0	0	0	0
	Green	GS63	0	0	0	0	0	0	1	1	1	1	1	1	0	0	0	0	0	0
Gray Scale of blue	Black	GS0	0	0	0	0	0	0	0	0	0	0	0	0	0	0	0	0	0	0
	↑	GS1	0	0	0	0	0	0	0	0	0	0	0	0	1	0	0	0	0	0
	Darker	GS2	0	0	0	0	0	0	0	0	0	0	0	0	0	1	0	0	0	0
	↑	↓				↓				↓				↓				↓		
	↓	↓				↓				↓				↓				↓		
	Brighter	GS61	0	0	0	0	0	0	0	0	0	0	0	0	1	0	1	1	1	1
	↓	GS62	0	0	0	0	0	0	0	0	0	0	0	0	0	1	1	1	1	1
	Bleu	GS63	0	0	0	0	0	0	0	0	0	0	0	0	1	1	1	1	1	1

0 : Low level voltage    1 : High level voltage

Each basic color can be displayed in 64 gray scales from 6 bit data signals. According to the combination of total 18 bit data signals, the 262,144-color display can be achieved on the screen.

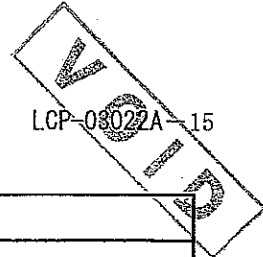

Table 10 3bit RGB color display mode (CO=Low)

Colors & Gray scale	Gray Scale	Data signal																	
		R0	R1	R2	R3	R4	R5	G0	G1	G2	G3	G4	G5	B0	B1	B2	B3	B4	B5
Basic color	Black	—	—	—	—	—	0	—	—	—	—	—	0	—	—	—	—	—	0
	Blue	—	—	—	—	—	0	—	—	—	—	—	0	—	—	—	—	—	1
	Green	—	—	—	—	—	0	—	—	—	—	—	1	—	—	—	—	—	0
	Cyan	—	—	—	—	—	0	—	—	—	—	—	1	—	—	—	—	—	1
	Red	—	—	—	—	—	1	—	—	—	—	—	0	—	—	—	—	—	0
	Magenta	—	—	—	—	—	1	—	—	—	—	—	0	—	—	—	—	—	1
	Yellow	—	—	—	—	—	1	—	—	—	—	—	1	—	—	—	—	—	0
	White	—	—	—	—	—	1	—	—	—	—	—	1	—	—	—	—	—	1

0 :Low level voltage    1 :High level voltage    — :High or Low level voltage constant

(9)Optical characteristics

9-1) Not driving the Back light condition

Table 11

Ta=25°C

Parameter	Symbol	Condition	Min	Typ	Max	Unit	Remarks
Viewing angle range	$\theta_{1,22}$	CR $\geq$ 2	20	30	-	degree	[Note 9-1,2]
	$\theta_{11}$		20	30	-	degree	
	$\theta_{12}$		20	30	-	degree	
Contrast ratio	CRmax	$\theta = 0^\circ$	3	5	-		[Note 9-2,4]
Response time	Rise	$\theta = 0^\circ$	-	30	60	ms	[Note 9-3]
	Fall		-	50	100	ms	
White chromaticity	x	$\theta = 0^\circ$	0.24	0.29	0.34		[Note 9-4]
	y		0.28	0.33	0.38		
Reflection ratio	R	$\theta = 0^\circ$	4	6	-	%	[Note 9-5]

\* The measuring method of the optical characteristics is shown by the following figure.

\* A measurement device is Otsuka luminance meter LCD5200.(With the diffusion reflection unit.)

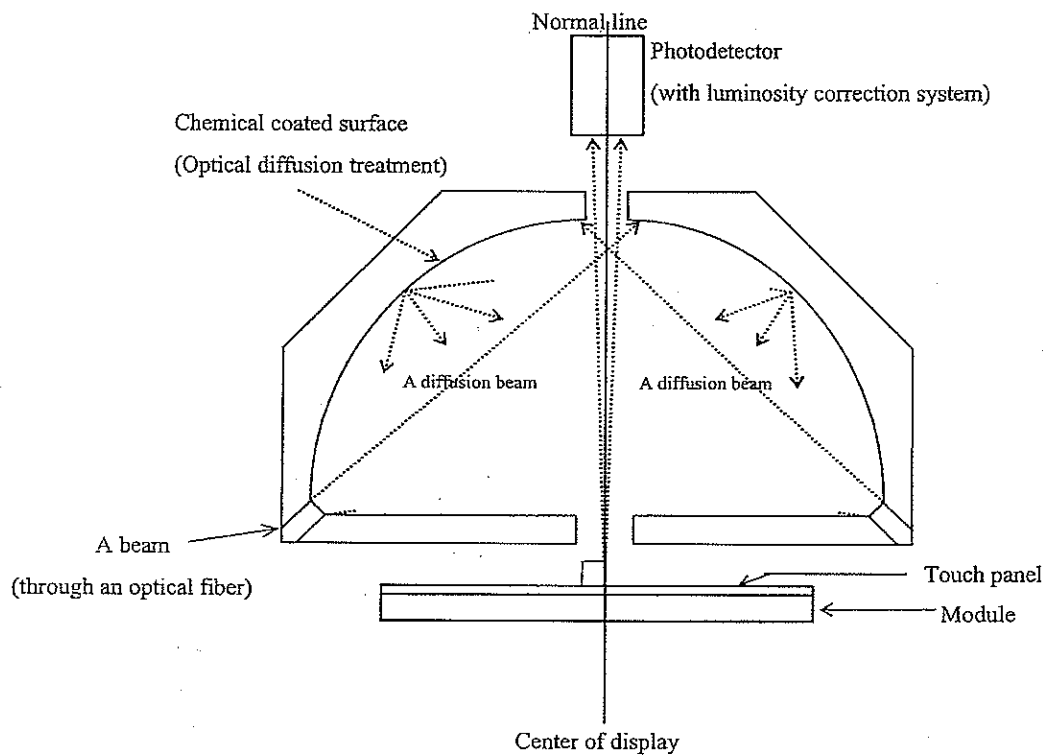

Measuring method (a) for optical characteristics



**VOID**  
LCP-03022A-17

9-2) Driving the Back light condition

Table 12

Ta=25°C

Parameter	Symbol	Condition	Min	Typ	Max	Unit	Remarks
Viewing angle range	$\theta_{21,22}$	CR $\geq$ 2	30	40	-	degree	[Note 9-1,2,6]
	$\theta_{11}$		30	40	-	degree	
	$\theta_{12}$		30	40	-	degree	
Contrast ratio	C <sub>max</sub>	$\theta = 0^\circ$	70	100	-		[Note 9-2]
Response time	Rise	$\tau_r$	-	30	60	ms	[Note 9-3]
	Fall		$\tau_d$	-	50	100	
White chromaticity	x	$\theta = 0^\circ$	0.24	0.30	0.35		
	y		0.26	0.32	0.37		
Uniformity	U	$\theta = 0^\circ$	70	-	-	%	[Note 9-7]
Brightness	Y	$\theta = 0^\circ$	55	70	-	(cd/m <sup>2</sup> )	IL=15mA



\* The measuring method of the optical characteristics is shown by the following figure.

\* A measurement device is TOPCON luminance meter BM-5(A).(Viewing cone 1)

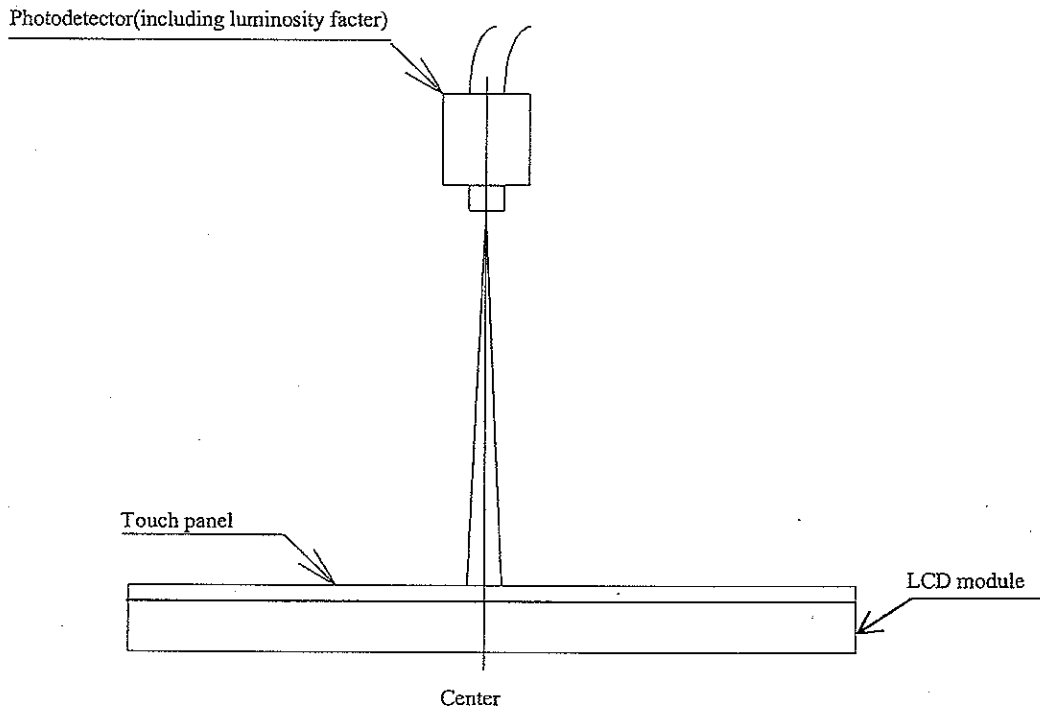

Measuring method (b) for optical characteristics

VOID

[Note 9-1] Viewing angle range is defined as follows.

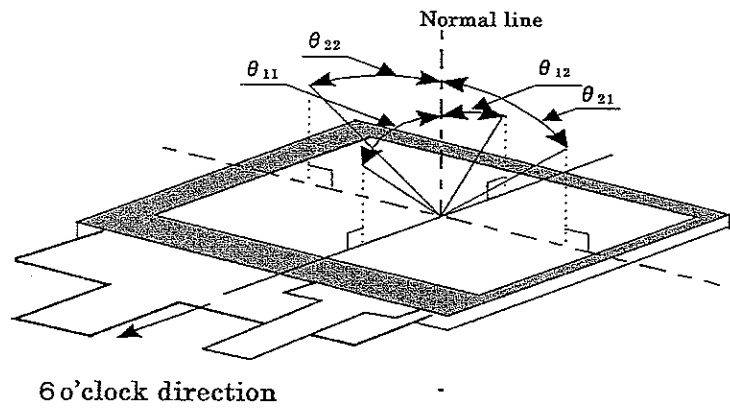

**Definition for viewing angle**

[Note 9-2] Definition of contrast ratio:

The contrast ratio is defined as follows:

$$\text{Contrast ratio(CR)} = \frac{\text{Photodetector output with all pixels white(GS63)}}{\text{Photodetector output with all pixels black(GS0)}} \times \frac{V_{COMAC}}{5.0V_{p-p}}$$

[Note 9-3] Definition of response time:

The response time is defined as the following figure and shall be measured by switching the input signal for "black" and "white".

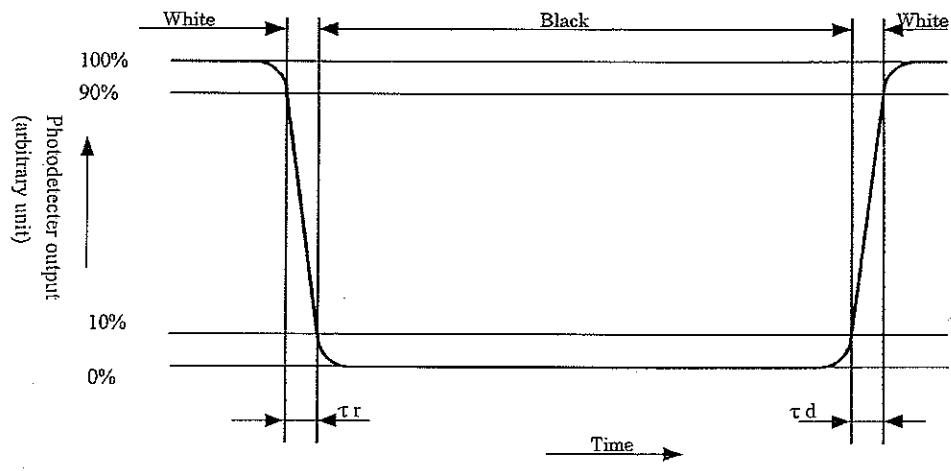

[Note 9-4] A measurement device is Minolta CM-2002.

[Note 9-5] Definition of reflection ratio

$$\text{Reflection ratio} = \frac{\text{Light detected level of the reflection by the LCD module}}{\text{Light detected level of the reflection by the standard white board}}$$

[Note 9-6] A measurement device is ELDIM EZContrast

[Note 9-7] Definition of Uniformity  $\Delta$

$$\text{Uniformity} = \frac{\text{Minimum Brightness}}{\text{Maximum Brightness}} \times 100 (\%)$$

The brightness should be measured on the 9-point as shown in the right figure.

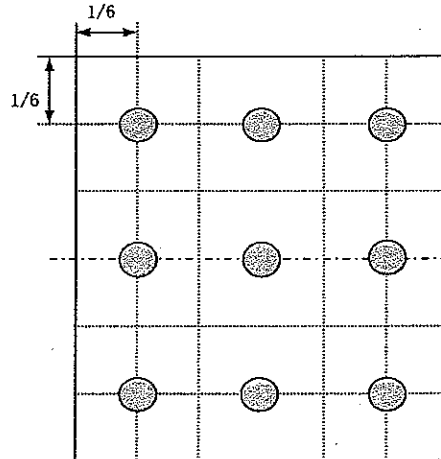

(10) Touch panel characteristics

Table 13

Parameter	Min.	Typ.	Max.	Unit	Remark
Input voltage	-	5	7	V	
Resistor between terminals(X1-X2)	190		620	$\Omega$	Provisional specification
Resistor between terminals(Y1-Y2)	150		570	$\Omega$	
Accuracy of detecting dimension	-		$\pm 1.5$	%	
Line linearity(X direction)	-	-	$\pm 1.5$	%	
Line linearity(Y direction)	-	-	$\pm 1.5$	%	
Insuration resistance	20	-	-	M $\Omega$	
Activation force	10	-	80	gf	[Note 10-1]

[Note 10-1] Test condition : End shape:R0.8mm,Resistance Between X and Y axis must be equal or lower than 2k $\Omega$ , the test voltage=DC5V

(11) Display quality

The display quality of the color TFT-LCD module shall be in compliance with the Incoming Inspection Standards for TFT-LCD..

(12) Mechanical characteristics

12-1) External appearance

See Fig. 1

12-2) FPC (for LCD panel) characteristics

(1) Specific connector

LCD-FPC : JAE FF0251SS1 (Bottom contact only)

T.P-FPC : JST 04(1.0)9FLH-RSM1-TB

(2) Bending endurance of the bending slits portion

No line of the FPC is broken for the bending test (Bending radius=0.6mm and angle=90°) in 30 cycles.

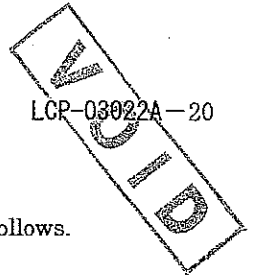

12-3) Design guidance for touchpanel(T/P)

12-3-1)Example of housing design

- (1)If an consumer will put a palm on housing in normal usage, care should be taken as follows.
- (2)Keep the gap, for example 0.3 to 0.7mm,between bezel edge and T/P surface.  
The reason is to avoid the bezel edge from contacting T/P surface that may cause a "short" with bottom layer(See Fig.2)
- (3)Insertion a cushion material is recommended.
- (4)The cushion material should be limited just on the busbar insulation paste area.  
If it is over the transparent insulation paste area, a "short" may be occurred.
- (5)There is one where a resistance film is left in the T/P part of the end of the pole.  
Design to keep insulation from the perimeter to prevent from mis-operation and so on.

12-3-2)Mounting on display and housing bezel

- (1)In all cases, the T/P should be supported from the backside of the glass.
- (2)Do not to use an adhesive-tape to bond it on the front of T/P and hang it to the housing bezel.
- (3)Never expand the T/P top layer (PET-film) like a balloon by internal air pressure.  
The life of the T/P will be extremely short.
- (4)Top layer, PET, dimension is changing with environmental temperature and humidity.  
Avoid a stress from housing bezel to top layer, because it may cause "waving".
- (5)The input to the Touchpanel sometimes distorts touch panel itself.

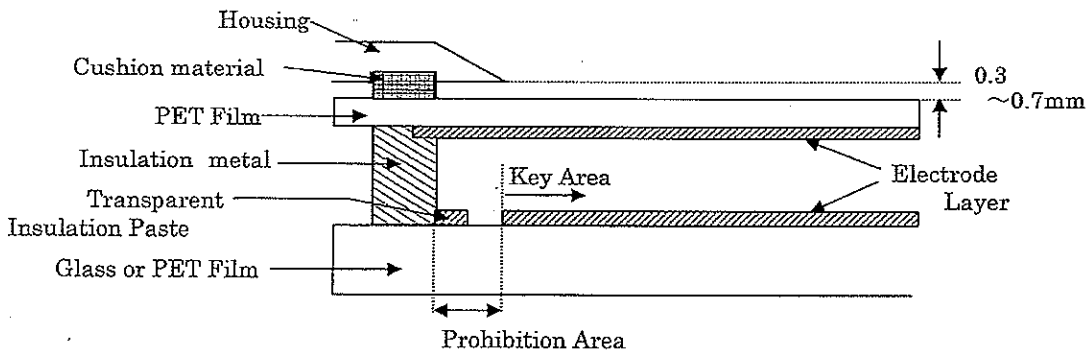
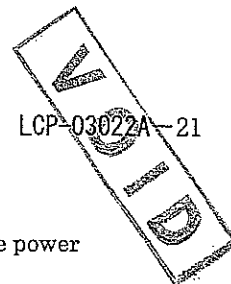

Fig.2



### (13) Handling Precautions

#### 13-1) Insertion and taking out of FPCs

Be sure insert and take out of the FPC into the connector of the set after turning off the power supply on the set side.

#### 13-2) Handling of FPCs

The FPC for LCD panel shall be bent only slit portion. The bending slit shall be bent uniformly on the whole slit portion with bending radius larger than 0.6mm, and only inner side (back side of the module). Don't bend it outer side (display surface side).

Don't give the FPCs too large force, for example, hanging the module with holding FPC.

#### 13-3) Installation of the module

On mounting the module, be sure to fix the module on the same plane. Taking care not to warp or twist the module.

#### 13-4) Precaution when mounting

- (1) If water droplets and oil attaches to it for a long time, discoloration and staining occurs. Wipe them off immediately.
- (2) Glass is used for the TFT-LCD panel or touch panel. If it is dropped or bumped against a hard object, it may be broken. Handle it with sufficient care.
- (3) As the CMOS IC is used in this module, pay attention to static electricity when handling it. Take a measure for grounding on the human body.

#### 13-5) Others

- (1) The liquid-crystal is deteriorated by ultraviolet rays. Do not leave it in direct sunlight and strong ultraviolet rays for many hours.
- (2) If it is kept at a temperature below the rated storage temperature, it becomes coagulated and the panel may be broken. Also, if it is kept at a temperature above the rated storage temperature, it becomes isotropic liquid and does not return to its original state. Therefore, it is desirable to keep it at room temperature as much as possible.
- (3) If the LCD breaks, don't put internal liquid crystal into the mouth. When the liquid crystal sticks to the hands, feet and clothes, wash it out immediately.
- (4) Wipe off water drop or finger grease immediately. Long contact with water may cause discoloration or spots.
- (5) Observe general precautions for all electronic components.
- (6) VCOM must be adjusted on condition of your final product. No adjustment causes the deterioration for display quality.
- (7) Static image should not be displayed more than 5 minutes in order to prevent from occurrence of residual image.

CP-03022A-22  
 VOID

(14) Reliability Test Conditions for TFT-LCD Module

Table 14

No.	Test items	Test conditions
1	High temperature storage test	Ta=+70°C 240h
2	Low temperature storage test	Ta=-20°C 240h
3	High temperature and high humidity operating test	Tp=+40°C , 95%RH 240h (But no condensation of dew)
4	High temperature operating test	Tp=+60°C 240h
5	Low temperature operating test	Tp=-10°C 240h
6	Electro static discharge test	±200V · 200pF(0Ω) 1 time for each terminals
7	Shock test	980 m/s <sup>2</sup> , 6 ms ±X, ±Y, ±Z 3 times for each direction (JIS C0041, A-7 Condition C)
8	Vibration test	Frequency range: 10Hz~55Hz Stroke: 1.5 mm Sweep: 10Hz~55Hz X, Y, Z 2 hours for each direction (total 6 hours) (JIS C0040, A-10 Condition A)
9	Heat shock test	Ta=-20°C~+70°C / 5 cycles (1h) (1h)
10	Point activation test (Touch panel)	Hit it (1,000,000) times with a silicon rubber of R8 HS 60. Hitting force : 250g Hitting speed : 3 times per second
11	Writing friction resistance test (Touch panel)	Write according to the right illustration in the under-mentioned conditions: Pen : 0.8R Polyacetal stylus Load : 250gf Speed : 3 strokes per second Stroke : 35mm Frequency : (50,000) times × 4 pieces Testing apparatus : shown in Fig 3

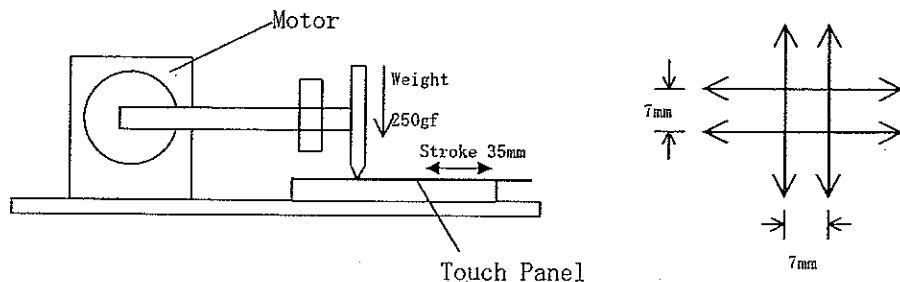

Fig.3

[Note]  $T_a$  = Ambient temperature,  $T_p$  = Panel temperature.

[Check items]

• Test No.1~9

In the standard condition, there shall be no practical problems that may affect the display function.

• Test No.10~No.11

The measurements after the tests are satisfied (10)-Table 13 (Touch panel characteristics)

(15) Others

15-1) Indication of lot number

The lot number is shown on a label. Attached location is shown in Fig.1 (Outline Dimensions).

Indicated contents of the label

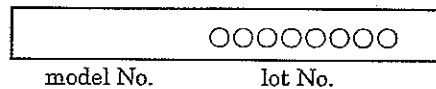

15-2) Used Regulation of Chemical Substances Breaking Ozone Stratum

Substances with the object of regulating : CFCS, Carbon tetrachloride, Halon

1,1,1-Trichloro ethane (Methyl chloroform)

- (a) This LCD module, Constructed part and Parts don't contain the above substances.
- (b) This LCD module, Constructed part and Parts don't contain the above substances in processes of manufacture.

VOID

LCP-0302A-2

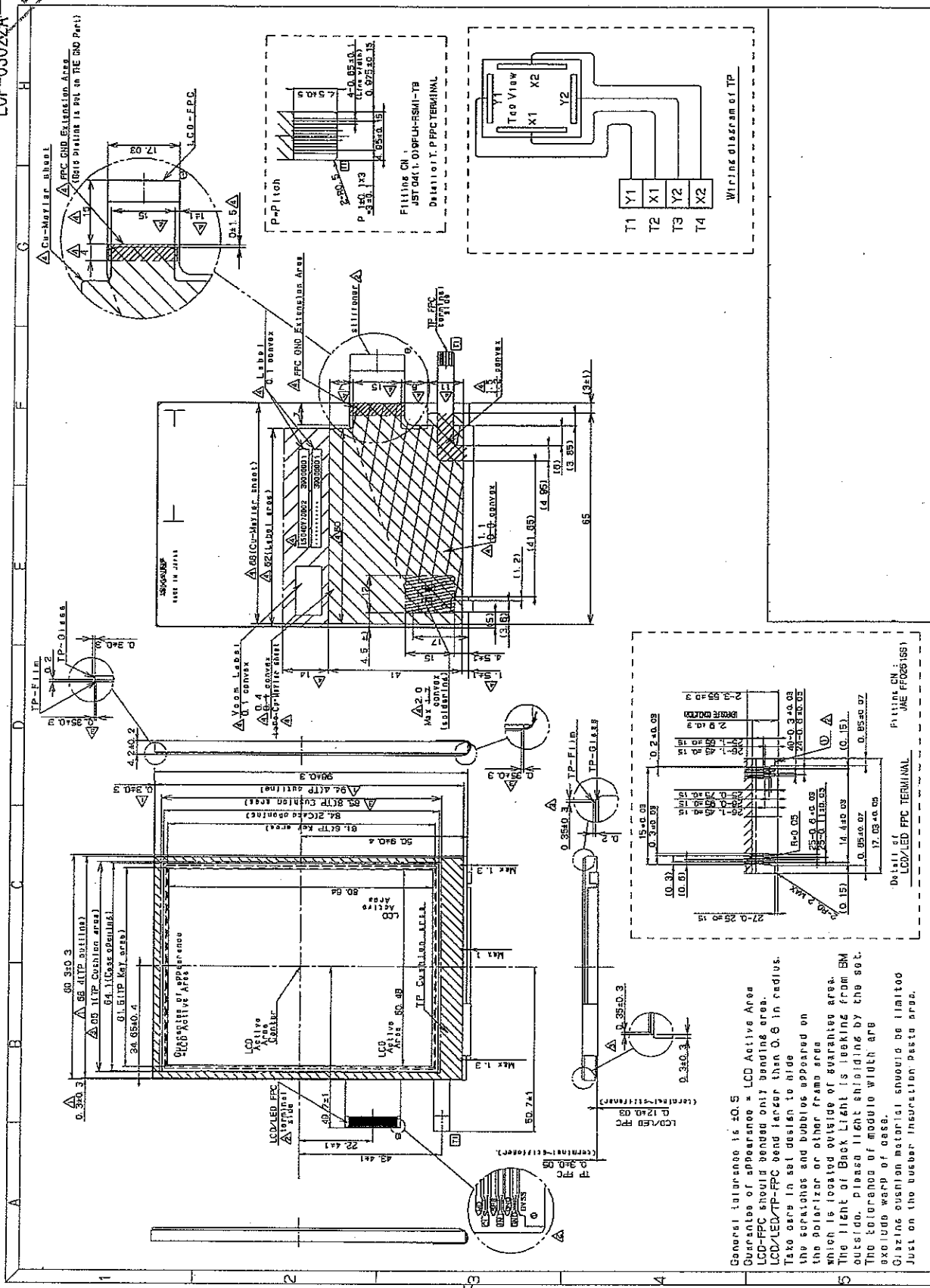

General tolerance is ±0.5  
 Guarantee of appearance = LCD Active Area  
 LCD-FPC should bend only bending area.  
 LCD/LED/TP-FPC bend larger than 0.6 in radius.  
 Take care in set design to hide the polarizer and bubbles appeared on which is located outside of guarantee area.  
 The light of Back Light is leaking from EM outside, please light shielding by the set.  
 The tolerance of module width are excluding warp of base.  
 Glazing cushion material should be limited Just on the rubber insulation paste area.

Fig. I Outline Dimensions