

POWER MANAGEMENT

60mA/110mA/160mA Super Low Dropout CMOS Regulators with Battery Life Extending Shutdown Mode

The IMP2014, IMP2015 and IMP2185 high performance CMOS low dropout voltage regulators offer superior dropout voltage performance and load regulation characteristics as compared to the pin compatible TC1014/1015/1185 devices offered by TelCom Semiconductor. Dropout voltage performance has been improved by up to 40%.

Load regulation and power supply PSRR have been optimized. Load regulation is typically 0.32% and PSRR is 53dB at 1kHz.

A logic input controlled shutdown mode extends system battery life by reducing quiescent current to 0.2µA maximum. The shutdown mode can be initiated by a system microcontroller.

The regulators were designed with ease of use and stability in mind. Stability is guaranteed for 0.47µF and greater load capacitors with an ESR up to 5Ω. Ceramic or tantalum capacitors can be used.

Three devices with different guaranteed output current specifications are available: IMP2014 (60mA), IMP2015 (110mA) and IMP2185 (160mA). Each device has output voltage options of 2.5V, 2.7V, 2.85V, 3.0V, 3.3V, 3.6V and 4.0V.

Key Features

- ◆ Pin Compatible with TelCom TC1014/1015/1185
- ◆ Lower Dropout Voltage for Long Battery Life
 - IMP2014: 70mV vs. TelCom TC1014 120mV
 - IMP2015: 160mV vs. TelCom TC1015 250mV
 - IMP2185: 250mV vs. TelCom TC1185 400mV
- ◆ Power Saving Shutdown Mode
 - 0.2µA shutdown current
- ◆ Superior Load Regulation
 - 0.32%
- ◆ Long Battery Life
 - 33µA no load ground current
- ◆ Accurate Output Voltage
 - ± 2.5% over temperature
- ◆ Low Drift Output: 40ppm/°C
- ◆ Guaranteed Minimum Output Current
 - IMP2014: 60mA
 - IMP2015: 110mA
 - IMP2185: 160mA
- ◆ Over-Current and Over-Temperature Protection
- ◆ Reference Bypass Input for Low-noise and Improved PSRR
- ◆ Compact SOT-23A-5 Package

Applications

- ◆ Pagers
- ◆ Cellular/GSM/PHS Phones
- ◆ Instrumentation
- ◆ Wireless Terminals
- ◆ Battery Powered Systems
- ◆ Medical Instruments
- ◆ Linear Post-Regulators

Typical Application

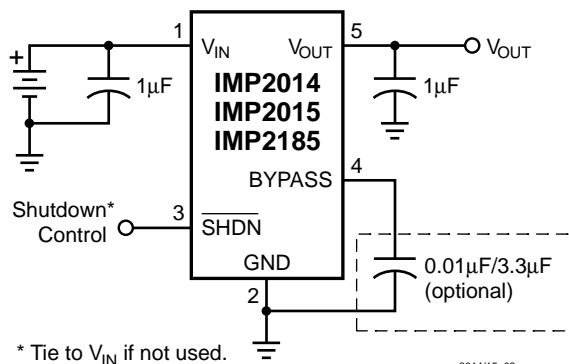

Pin Configuration

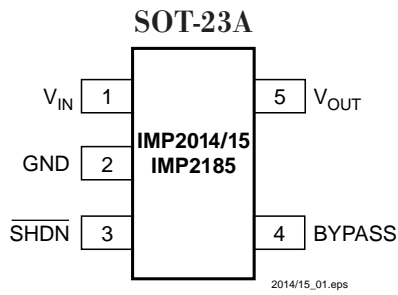

Pin Descriptions

Pin Number	Name	Function
1	V _{IN}	Unregulated supply input.
2	GND	Ground terminal.
3	SHDN	Shutdown control input. A shutdown mode is entered when SHDN is a logic LOW. During shutdown the output voltage falls to 0V and quiescent current drops to 2.0μA.
4	BYPASS	Reference bypass input. A capacitor connected from the BYPASS pin to ground reduces the noise present on the internal reference and enhances PSRR
5	V _{OUT}	Output voltage

2014/15_01.eps

Ordering Information

Part Number*	Package	Output Voltage (V)	Output Current (mA)	Shutdown Pin	Adjust Pin	OKAY Flag Output	Reference Bypass Pin	Package Marking			
								A	B	C	D
IMP2014-2.5JUK/T	SOT23A-5	2.5	60	●			●	M	A	x	x
IMP2014-2.7JUK/T	SOT23A-5	2.7	60	●			●	M	B	x	x
IMP2014-2.85JUK/T	SOT23A-5	2.85	60	●			●	M	C	x	x
IMP2014-3.0JUK/T	SOT23A-5	3.0	60	●			●	M	D	x	x
IMP2014-3.3JUK/T	SOT23A-5	3.3	60	●			●	M	E	x	x
IMP2014-3.6JUK/T	SOT23A-5	3.6	60	●			●	M	F	x	x
IMP2014-4.0JUK/T	SOT23A-5	4.0	60	●			●	M	G	x	x
IMP2015-2.5JUK/T	SOT23A-5	2.5	110	●			●	O	A	x	x
IMP2015-2.7JUK/T	SOT23A-5	2.7	110	●			●	O	B	x	x
IMP2015-2.85JUK/T	SOT23A-5	2.85	110	●			●	O	C	x	x
IMP2015-3.0JUK/T	SOT23A-5	3.0	110	●			●	O	D	x	x
IMP2015-3.3JUK/T	SOT23A-5	3.3	110	●			●	O	E	x	x
IMP2015-3.6JUK/T	SOT23A-5	3.6	110	●			●	O	F	x	x
IMP2015-4.0JUK/T	SOT23A-5	4.0	110	●			●	O	G	x	x
IMP2185-2.5JUK/T	SOT23A-5	2.5	160	●			●	X	A	x	x
IMP2185-2.7JUK/T	SOT23A-5	2.7	160	●			●	X	B	x	x
IMP2185-2.85JUK/T	SOT23A-5	2.85	160	●			●	X	C	x	x
IMP2185-3.0JUK/T	SOT23A-5	3.0	160	●			●	X	D	x	x
IMP2185-3.3JUK/T	SOT23A-5	3.3	160	●			●	X	E	x	x
IMP2185-3.6JUK/T	SOT23A-5	3.6	160	●			●	X	F	x	x
IMP2185-4.0JUK/T	SOT23A-5	4.0	160	●			●	X	G	x	x

xx = Date Code

* /T indicates Tape and Reel

2014/15_03.eps

Absolute Maximum Ratings

Input Voltage 7V
 Output Voltage -0.3V to $V_{IN} + 0.3V$
 Maximum Voltage on Any Pin -0.3V to $(V_{IN} + 0.3V)$
 Shutdown Voltage (\overline{SHDN}) $\overline{SHDN} \leq V_{IN} + 0.3V$

These are stress ratings only and functional operation is not implied. Exposure to absolute maximum ratings for prolonged time periods may affect device reliability. All voltages are with respect to ground.

Operating Junction Temperature Range ... $-40^{\circ}C < T_J < 125^{\circ}C$
 Storage Temperature $-65^{\circ}C$ to $150^{\circ}C$
 Power Dissipation Internally limited

Note: T_J = Junction Temperature, T_A = Ambient Temperature

Electrical Characteristics

$V_{IN} = V_{OUT} + 1V$, $I_L = 100\mu A$, $C_L = 1\mu F$, $\overline{SHDN} > V_{IH}$, $T_A = 25^{\circ}C$, unless otherwise noted. **Bold/blue** specifications apply for junction temperature range $-40^{\circ}C < T_J < 125^{\circ}C$.

Parameter	Symbol	Conditions	Min	Typ	Max	Units
Input Voltage Range	V_{IN}	$0^{\circ}C < T_J < 125^{\circ}C$			6.50	V
		$-40^{\circ}C < T_J < 125^{\circ}C$			6.50	
Maximum Output Current	I_{OMAX}	IMP2014	60			mA
		IMP2015	110			
		IMP2185	160			
Fixed Output Voltage	V_{OUT}	Note 1	$V_R - 2.5\%$	$V_R \pm 0.5\%$	$V_R + 2.5\%$	V
Dropout Voltage (Note 2)	$V_{IN} - V_O$	$I_L = 100\mu A$		1		mV
		$I_L = 20mA$		17	23	
		$I_L = 50mA$		60	70	
		$I_L = 100mA$ (IMP2015, IMP2185)		90	160	
		$I_L = 150mA$ (IMP2185)		143	250	
Quiescent Current (Ground Current)		No load		33	50	μA
Shutdown Supply Current	I_{INSD}	$\overline{SHDN} = 0V$ $T_J \leq 25^{\circ}C$		0.2	2	μA
Output Temperature Coefficient				40		ppm/ $^{\circ}C$
Thermal Regulation				0.04		%/W
Line Regulation		$V_R + 1V \leq V_{IN} \leq 6V$		0.0375	0.35	%

- Notes: 1. V_R is the regulated output voltage: 2.5V, 2.7V, 2.85V, 3.0V, 3.3V, 3.6V or 4.0V.
 2. Dropout Voltage is defined as the difference between IN and OUT when V_R drops 2% below its nominal value.
 3. Specifications which would otherwise be affected by self-heating of the die are tested at a constant die temperature by using low duty cycle pulse testing.
 3. PSRR guaranteed by design.

2014/15_102a.eps

Electrical Characteristics

$V_{IN} = V_{OUT} + 1V$, $I_L = 100\mu A$, $C_L = 1\mu F$, $\overline{SHDN} > V_{IH}$, $T_A = 25^\circ C$, unless otherwise noted. **Bold/blue** specifications apply for junction temperature range of $-40^\circ C < T_j < 125^\circ C$.

Parameter	Symbol	Conditions	Min	Typ	Max	Units
Load Regulation: IMP2014		$I_L = 100\mu A$ to 50mA		0.11	0.5	%
IMP2015		$I_L = 100\mu A$ to 100mA		0.16	1.0	
IMP2185		$I_L = 100\mu A$ to 150mA		0.65	1.5	
Thermal Shutdown Die Temperature				150		$^\circ C$
Thermal Shutdown Hysteresis				12		$^\circ C$
Ripple Rejection	PSRR	$V_{IN} \geq (V_O + 1V) \pm 0.25V$ $C_O = 3.3\mu F$ ceramic $C_{BYPASS} = 0.01\mu F$	Freq. = 1kHz	60		dB
			Freq. = 10kHz	47		
			Freq. = 1MHz	34		
Output Noise		300Hz to 50kHz No bypass capacitor $I_L = 50mA$ (IMP2014) $I_L = 100mA$		280		μV_{RMS}
		300Hz to 50kHz $C_{BYPASS} = 0.01\mu F$ $I_L = 50mA$ (IMP2014) $I_L = 100mA$		60		μV_{RMS}
SHDN Input HIGH Threshold		$2.5V \leq V_{IN} \leq 6.5V$	45			% of V_{IN}
SHDN Input LOW Threshold		$2.5V \leq V_{IN} \leq 6.5V$			15	% of V_{IN}
Reverse Current into V_{OUT}		$V_{(IN)} < V_{(OUT)}$ SHDN = HIGH = V_{IN}		2.0		mA
		$V_{(IN)} < V_{(OUT)}$ SHDN = LOW		2.7		μA
Output Current Limit				350	600	mA

Notes: 1. V_R is the regulated output voltage: 2.5V, 2.7V, 2.85V, 3.0V, 3.3V, 3.6V or 4.0V.

2. Dropout Voltage is defined as the difference between IN and OUT when V_R drops 2% below its nominal value.

3. Specifications which would otherwise be affected by self-heating of the die are tested at a constant die temperature by using low duty cycle pulse testing.

4. PSRR guaranteed by design.

2014/15_102b.eps

Typical Characteristics

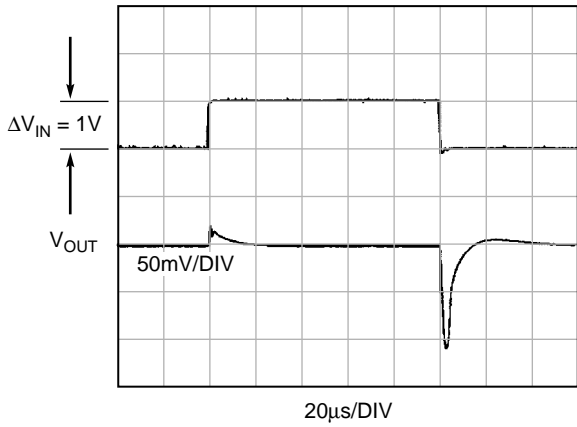

2014/15_12.eps

Figure 1. Line Transient Response

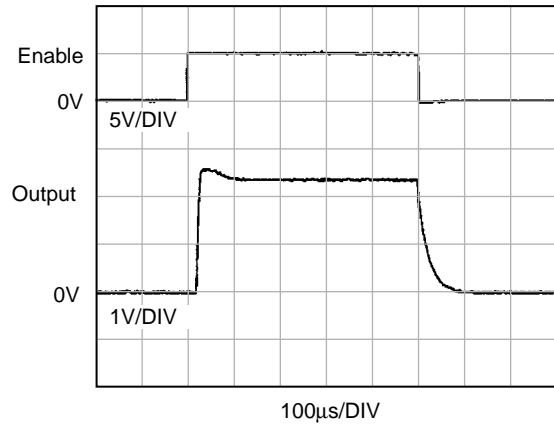

2014/15_13.eps

Figure 2. Enable Input Response

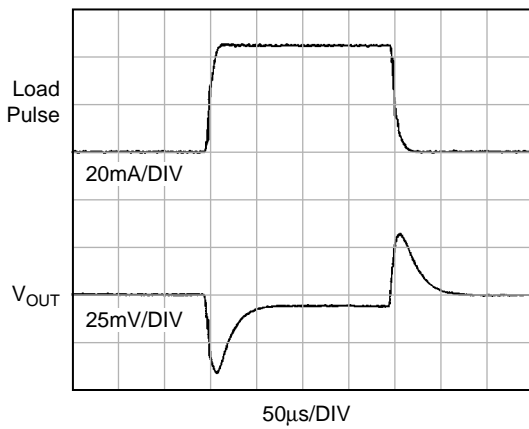

2014/15_09.eps

Figure 3. Load Transient Response (50mA Step)

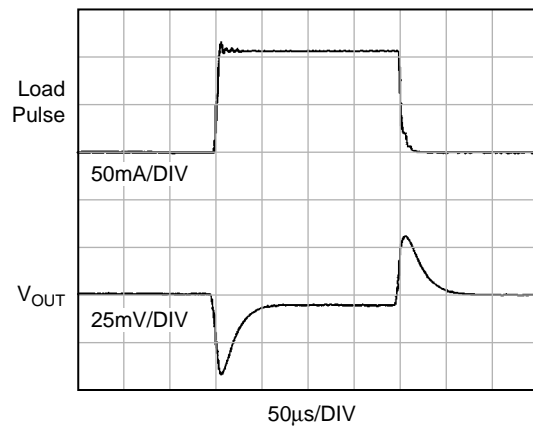

2014/15_10.eps

Figure 4. Load Transient Response (100mA Step)

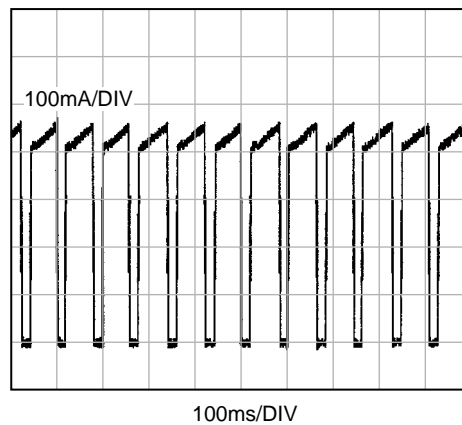

2014/15_11.eps

Figure 5. Output Short Circuit Response

Application Information

The IMP2014, IMP2015 and IMP2185 have been designed to offer exceptionally low dropout voltage, superior load regulation and minimum quiescent power.

Shutdown Mode

A battery-life-extending mode is available. Through the active LOW shutdown pin, $\overline{\text{SHDN}}$, the regulator can be enabled or turned off. The regulator is shutdown (turned off) when SHDN is LOW and enabled (turned on) when $\overline{\text{SHDN}}$ is HIGH.

The shutdown signal can be supplied from a CMOS gate or from an I/O port of a microcontroller.

During shutdown, the output voltage falls to 0V and the supply current is typically only 200nA.

If the shutdown mode is not needed, $\overline{\text{SHDN}}$ should be connected directly to the regulator input voltage pin.

Output Capacitor

The IMP2014, IMP2015 and IMP2185 were designed for stable operation with a wide range of capacitor values and type. The output capacitor should be above 0.47 μF . A 1 μF value is recommended. Ceramic or tantalum capacitors are suitable with an ESR of up to 5 Ω .

Reference Voltage Bypass Capacitor

For low noise operation a 0.01 μF or larger capacitor can be connected from the BYPASS pin to ground. For maximum power supply rejection/line rejection, a 3.3 μF value is suggested.

The IMP2014/2015/2185 were designed so that line regulation and ripple rejection would be maximized. This was accomplished by powering the internal bandgap reference from an internal regulated source. This "pre-regulation" greatly improves power supply regulation for input voltages greater than that of the internal voltage regulator, 3.5V.

Thermal Shutdown

An on-chip thermal protection circuit shuts the LDO regulator off when the die temperature exceeds 150°C. There is a built in 12°C hysteresis. The regulator will remain off until the die temperature drops to approximately to 138°C.