

Self Diagnosis
Supported model

SERVICE MANUAL

FE-2 CHASSIS

MODEL	COMMANDER	DEST	CHASSIS NO.	MODEL	COMMANDER	DEST	CHASSIS NO.
KV-25FX30B	RM-887	FR	SCC-Q54H-A	KV-29FX30B	RM-887	FR	SCC-Q54J-A
KV-25FX30E	RM-887	ESP	SCC-Q53J-A	KV-29FX30E	RM-887	ESP	SCC-Q53K-A
KV-25FX30K	RM-887	OIRT	SCC-Q51K-A	KV-29FX30K	RM-887	OIRT	SCC-Q51L-A

FD Trinitron



TRINITRON® COLOR TV

SONY®

TABLE OF CONTENTS

Section	Title	Page	Section	Title	Page
	Specifications	3	4. CIRCUIT ADJUSTMENTS		
	Connectors	4	4-1.	Electrical Adjustments	20
	Self Diagnostic Software	5	4-2.	Test Mode 1	22
1. GENERAL			4-3.	Test Mode 2	22
	Switching On the TV and Automatically Tuning	6	5. DIAGRAMS		
	Introducing the Menu System	7	5-1.	Block Diagrams	23
	Teletext	10	5-2.	Circuit Board Location	26
	Connecting Optional Equipment.....	10	5-3.	Schematic Diagrams and Printed Wiring Boards	26
	Specifications	11		* C Board	27
	Troubleshooting	11		* A Board	30
2. DISASSEMBLY			5-4.	Semiconductors	33
	2-1. Rear Cover Removal	12	5-5.	IC Blocks	35
	2-2. Chassis Removal	12	6. EXPLODED VIEWS		
	2-3. A Board PWB Removal 1	13	6-1.	Chassis	36
	2-4. A Board PWB Removal 2	13	6-2.	Picture Tube	37
	2-5. Service Position	13	7. ELECTRICAL PARTS LIST		38
	2-6. Picture Tube Removal	14			
	Bottom Plates	15			
3. SET-UP ADJUSTMENTS					
	3-1. Beam Landing	16			
	3-2. Convergence	17			
	3-3. Focus Adjustment	19			
	3-4. Screen (G2), White Balance	19			

CAUTION

SHORT CIRCUIT THE ANODE OF THE PICTURE TUBE AND THE ANODE CAP TO THE METAL CHASSIS, CRT SHIELD, OR THE CARBON PAINTED ON THE CRT, AFTER REMOVAL OF THE ANODE CAP.

WARNING !!

AN ISOLATION TRANSFORMER SHOULD BE USED DURING ANY SERVICE WORK TO AVOID POSSIBLE SHOCK HAZARD DUE TO LIVE CHASSIS, THE CHASSIS OF THIS RECEIVER IS DIRECTLY CONNECTED TO THE POWER LINE.

SAFETY-RELATED COMPONENT WARNING !!

COMPONENTS IDENTIFIED BY SHADING AND MARKED Δ ON THE SCHEMATIC DIAGRAMS, EXPLODED VIEWS AND IN THE PARTS LIST ARE CRITICAL FOR SAFE OPERATION. REPLACE THESE COMPONENTS WITH SONY PARTS WHOSE PART NUMBERS APPEAR AS SHOWN IN THIS MANUAL OR IN SUPPLEMENTS PUBLISHED BY SONY.

ATTENTION

APRES AVOIR DECONNECTE LE CAP DE L'ANODE, COURT-CIRCUITER L'ANODE DU TUBE CATHODIQUE ET CELUI DE L'ANODE DU CAP AU CHASSIS METALLIQUE DE L'APPAREIL, OU AU COUCHE DE CARBONE PEINTE SUR LE TUBE CATHODIQUE OU AU BLINDAGE DU TUBE CATHODIQUE.

ATTENTION !!

AFIN D'EVITER TOUT RISQUE D'ELECTROCUTION PROVENANT D'UN CHASSIS SOUS TENTION, UN TRANSFORMATEUR D'ISOLEMENT DOIT ETRE UTILISE LORS DE TOUT DEPANNAGE LE CHASSIS DE CE RECEPTEUR EST DIRECTMENT RACCORDE A L'ALIMENTATION SECTEUR.

ATTENTION AUX COMPOSANTS RELATIFS A LA SECURITE!!

LES COMPOSANTS IDENTIFIES PAR UNE TRAME ET PAR UNE MARQUE Δ SUR LES SCHEMAS DE PRINCIPE, LES VUES EXPLOSEES ET LES LISTES DE PIECES SONT D'UNE IMPORTANCE CRITIQUE POUR LA SECURITE DU FONCTIONNEMENT, NE LES REMPLACER QUE PAR DES COMPSANTS SONY DONT LE NUMERO DE PIECE EST INDIQUE DANS LE PRESENT MANUEL OU DANS DES SUPPLEMENTS PUBLIES PAR SONY.

ITEM MODEL	Television System	Stereo System	Channel Coverage	Color System
B	B/G/H, D/K, I, L	GERMAN/NICAM Stereo	VHF : E2-E12, F2-F10 UHF : E21-E69, F21-F69, B21-B69 CABLE TV : S01-S03, S1-S20, B-Q HYPER : S21-S41	PAL, SECAM NTSC4.43, NTSC3.58 (VIDEO IN)
E	B/G/H, D/K	GERMAN/NICAM Stereo	VHF : E2-E12 UHF : E21-E69 CABLE TV : S01-S03, S1-S20 HYPER : S21-S41	PAL, SECAM NTSC4.43, NTSC3.58 (VIDEO IN)
K	B/G/H, D/K	GERMAN/NICAM Stereo	VHF : E2-E12, R01-R12 UHF : E21-E69, R21-R69 CABLE TV : S01-S03, S1-S20 HYPER : S21-S41	PAL, SECAM NTSC4.43, NTSC3.58 (VIDEO IN)

Picture Tube	Flat Display FD Trinitron Approx 63 cm (25 inches) (Approx 59 cm picture measured diagonally) Approx 73 cm (29 inches) (Approx 67 cm picture measured diagonally)	Sound output	
		Right and Left speaker	2x14W (Music Power) 2x7W (RMS)
		General Specifications	
Input/Output Terminals [REAR]		Power Requirements	220 - 240V
1: 21-pin Euro connector (CENELEC standard)	Inputs for Audio and Video signals. Inputs for RGB. Outputs of TV Video and Audio signals.	Power Consumption	KV-25FX30 : 87 W KV-29FX30 : 94 W
2: 21-pin Euro connector	Inputs for Audio and Video signals. Inputs for S Video. Outputs of TV Video and Audio signals. (selectable)	Dimensions	KV-25FX30 Approx 655x509x476 mm KV-29FX30 Approx 746x569x516 mm
		Weight	KV-25FX30 Approx 36kg KV-29FX30 Approx 46.5kg
RCA Connectors	Variable Output for audio signals	Supplied Accessories	RM-887 Remote Commander (1) IEC designated R6 battery (2)
Input/Output Terminals [FRONT]		Other Features	TV system Autodetection, Teletext Smartlink
Headphone jack	stereo mini jack	Remote Control System : Infrared Control	
Audio inputs	phono jacks	Power requirements	3V dc 2 batteries IEC designation R6 (size AA)
Video inputs	phono jacks		
S Video input	4 pin DIN		
Design and specifications are subject to change without notice.			

Model Name Item	KV-25FX30B	KV-25FX30E	KV-25FX30K
	KV-29FX30B	KV-29FX30E	KV-29FX30K
Pal Comb	OFF	OFF	OFF
PIP	OFF	OFF	OFF
RGB Priority	ON	ON	ON
Woofer Box	OFF	OFF	OFF
Scart 1	ON	ON	ON
Scart 2	ON	ON	ON
Front in (3)	ON	ON	ON
Scart 4	OFF	OFF	OFF
Projector	OFF	OFF	OFF
Norm B/G	ON	ON	ON
Norm I	ON	OFF	OFF
Norm D/K	ON	ON	ON
Norm AUS	OFF	OFF	OFF
Norm L	ON	OFF	OFF
Norm SAT	OFF	OFF	OFF
Norm M	OFF	OFF	OFF
Teletext	ON	ON	ON
Nicam Stereo	ON	ON	ON

21 pin connector

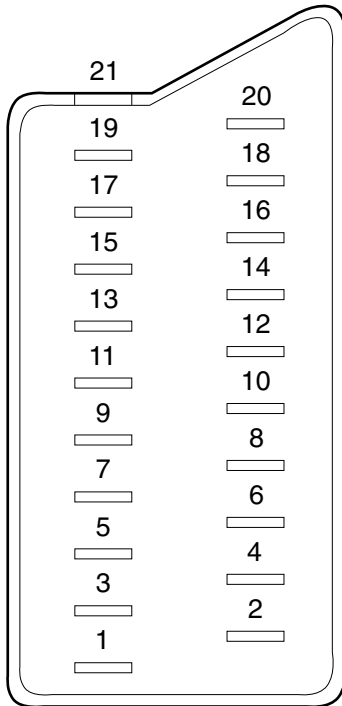

Pin No	1	2	4	Signal	Signal level
1	○	○	○	Audio output B (right)	Standard level : 0.5V rms Output impedance : Less than 1kohm*
2	○	○	○	Audio output B (right)	Standard level : 0.5V rms Output impedance : More than 10kohm*
3	○	○	○	Audio output A (left)	Standard level : 0.5V rms Output impedance : Less than 1kohm*
4	○	○	○	Ground (audio)	
5	○	○	○	Ground (blue)	
6	○	○	○	Audio input A (left)	Standard level : 0.5V rms Output impedance : More than 10kohm*
7	○	●	●	Blue input	0.7 +/- 3dB, 75 ohms positive
8	○	○	○	Function select (AV control)	High state (9.5-12V) : Part mode Low state (0-2V) : TV mode Input impedance : More than 10K ohms Input capacitance : Less than 2nF
9	○	○	○	Ground (green)	
10	○	○	○	Open	
11	○	●	●	Green	Green signal : 0.7 +/- 3dB, 75 ohms, positive
12	○	○	○	Open	
13	○	○	○	Ground (red)	
14	○	○	○	Ground (blanking)	
15	○	-	-	Red input	0.7 +/- 3dB, 75 ohms, positive
	-	○	○	(S signal Chroma input)	0.3 +/- 3dB, 75 ohms, positive
16	○	●	●	Blanking input (Ys signal)	High state (1-3V) Low state (0-0.4V) Input impedance : 75 ohms
17	○	○	○	Ground (video output)	
18	○	○	○	Ground (video input)	
19	○	○	○	Video output	1V +/- 3dB, 75ohms, positive sync 0.3V (-3+10dB)
20	○	-	-	Video input	1V +/- 3dB, 75ohms, positive sync 0.3V (-3+10dB)
	-	○	○	Video input Y (S signal)	1V +/- 3dB, 75ohms, positive sync 0.3V (-3+10dB)
21	○	○	○	Common ground (plug, shield)	

○ Connected ● Not Connected (open) * at 20Hz - 20kHz

Rear Connection Panel

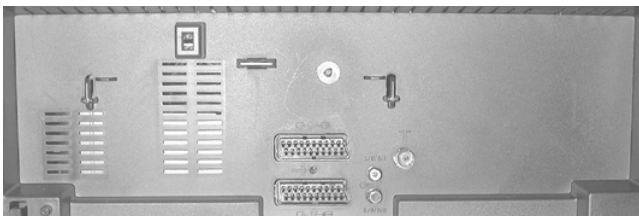

Front Connection Panel



S-Video socket

S Video socket pin configuration		
Pin No	Signal	Signal Level
1	Ground	-
2	Ground	-
3	Y (S signal) input	1V +/- 3dB 75ohm, positive Sync. 0.3V -3 +10dB
4	C (S signal) input	0.3V +/- 3dB 75ohm, positive Sync.

FE-2 SELF DIAGNOSTIC SOFTWARE

The identification of errors within the FE-2 chassis is triggered in one of two ways :- 1: Busy or 2: Device failure to respond to IIC. In the event of one of these situations arising the software will first try to release the bus if busy (Failure to do so will report with a continuous flashing LED) and then communicate with each device in turn to establish if a device is faulty. If a device is found to be faulty the relevant device number will be displayed through the LED (Series of flashes which must be counted) See table 1., non fatal errors are reported using this method. Each time the software detects an error it is stored within the NVM. See Table 2.

Table 1

Error Message	LED Code
No error	00
Reserved	01
OCP (Over Current Protection)	02
Not Used	03
No Vertical Sync	04
IKR Error at power on	05
IIC bus clock and/or data lines low at power on	06
NVM no IIC bus acknowledge at power on	07
Not Used	08
Tuner no acknowledge at power on	09
Sound Processor Error	10
Jungle controller 8 volts error	11

How to enter into Table 2

1. Turn on the main power switch of the TV set and enter into the 'Standby Mode'.
2. Press the following sequence of buttons on the Remote Commander.

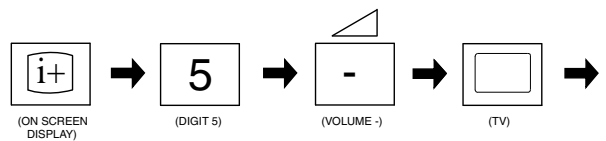

3. The following table will be displayed indicating the error count.

Flash Timing Example : e.g. error number 3

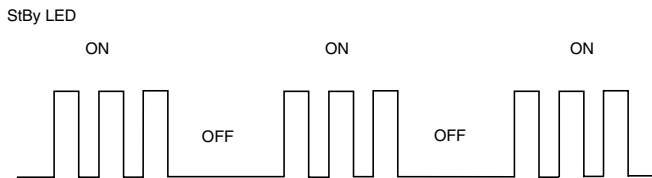

Table 2



ERROR MENU			
E02	OCP	(0, 255)	0
E03	OVP N/A	(0, 255)	0
E04	VSYNC	(0, 255)	0
E05	IKR	(0, 255)	0
E06	IIC	(0, 255)	0
E07	NVM	(0, 255)	0
E08	JUNGLE	(0, 255)	0
E09	TUNER	(0, 255)	0
E10	SOUNDP	(0, 255)	0
E11	8V	(0, 255)	0
WORKING TIME			
HOURS			2
MINUTES			11

Note: To clear the error count data press '80' on the Remote commander.

The operating instructions mentioned here are partial abstracts from the 'Operating Instruction Manual'. The page numbers of the 'Operating Instruction Manual' remain as in the manual.



Switching On the TV and Automatically Tuning

1 The first time you switch on your TV, a sequence of menu screens appear on the TV enabling you to: 1) choose the language of the menu screen, 2) choose the country in which you wish to operate the TV, 3) adjust the picture slant, 4) search and store all available channels (TV Broadcast) and 5) change the order in which the channels (TV Broadcast) appear on the screen.

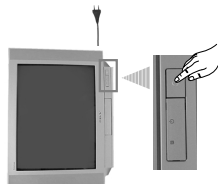

However, if you need to change any of these settings, you can do that by selecting the appropriate option in the  (Set Up menu) or by pressing the Auto Start Up Button  on the TV set.

1 Connect the TV plug to the mains socket (220-240V AC, 50Hz)
Press the  on/off button on the TV set to turn on the TV.
The first time you press this button, a Language menu displays automatically on the TV screen.

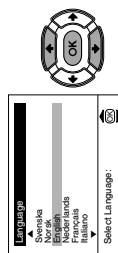

2 Press the  or  button on the remote control to select the language, then press the OK button to confirm your selection. From now on all the menus will appear in the selected language.





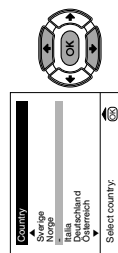



3 The Country menu appears automatically on the TV screen. Press the  or  button to select the country in which you will operate the TV set, then press the OK button to confirm your selection.



1 If the country in which you want to use the TV set does not appear in the list, select "-,-" instead of a country.

4 Because of the earth's magnetism, the picture might slant. The Picture Rotation menu allows you to correct the picture slant if it is necessary.

- a) If it is not necessary, press  or  to select **Not necessary** and press **OK**
- b) If it is necessary, press  or  to select **Adjust now**, then press **OK** and correct any slant of the picture between -5 and +5 by pressing  or . Finally press **OK** to store.

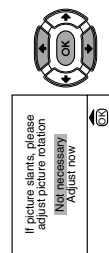

continued...

5 The Auto Tuning menu appears on the screen. Press the OK button to select **Yes**.

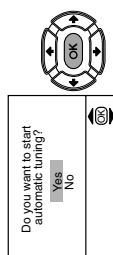

6 The TV starts to automatically search and store all available channels (TV Broadcast) for you.

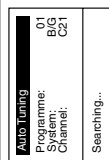

A This procedure could take some minutes. Please be patient and do not press any button. Otherwise the automatic tuning will not be completed.

A In the case that any channel have been found after the auto tuning process is completed, a new menu appears automatically on the screen asking you to connect the aerial. Please connect the aerial (see page 6) and press **OK**. The auto tuning process will start again.

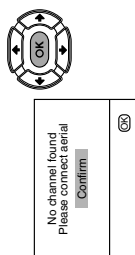



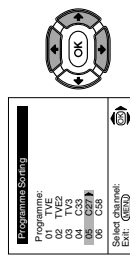



7 After all available channels are captioned and stored, the Programme Sorting menu appears automatically on the screen enabling you to change the order in which the channels appear on the screen.



a) If you do not wish to change the channel order, go to step 8.

b) If you wish to change the channel order:

- 1 Press the  or  button to select the programme number with the channel (TV Broadcast) you wish to rearrange, then press the  button.
- 2 Press the  or  button to select the new programme number position for your selected channel (TV Broadcast), then press .
- 3 Repeat steps b)1 and b)2 if you wish to change the order of the other channels.

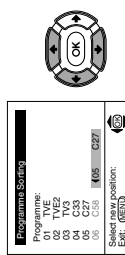

8 Press the **MENU** button to remove the menu from the screen.



 Your TV is now ready for use

Introducing and Using the Menu System

i Your TV uses an on-screen menu system to guide you through the operations. Use the following buttons on the Remote Control to operate the menu system:

1 Press the **MENU** button to switch the first level menu on.



2 To highlight the desired menu or option, press **↔** or **↕**.

To enter to the selected menu or option, press **→**.

To return to the last menu or option, press **←**.

To alter settings of your selected option, press **↔** / **↕** or **↔**.

To confirm and store your selection, press **OK**.



3 Press the **MENU** button to remove the menu from the screen.



GB

Menu Guide

Level 1

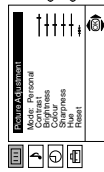

Level 2

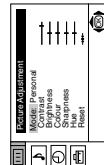

Level 3 / Function

PICTURE ADJUSTMENT
The "Picture Adjustment" menu allows you to alter the picture adjustments.

To do that: after selecting the item you want to alter press **→**, then press repeatedly **↔** / **↕** or **↔** or **↕** to adjust it and finally press **OK** to store the new adjustment.

This menu also allows you to customise the picture mode based on the programme you are watching:

- **Personal** (for individual settings).
- **Live** (for live broadcast programmes).
- **Movie** (for films).

- **Brightness, Colour and Sharpness** can only be altered if "Personal" mode is selected.
- **Hue** is only available for NTSC colour signal (e.g. USA video tapes).
- **Select Reset and press OK** to reset the picture to the factory preset levels.

continued...

Level 1

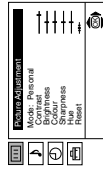

Level 2



Level 3 / Function

SOUND ADJUSTMENT

The "Sound Adjustment" menu allows you to alter the sound adjustments.

To do that: after selecting the item you want to alter, press **→** then press repeatedly **↔** / **↕** or **↔** or **↕** to adjust it and finally press **OK** to store the new adjustment.

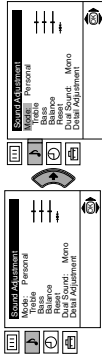

This menu also contains two submenus as following:

- Mode** →
 - **Personal** (for individual settings)
 - **Rock**
 - **Pop**
 - **Jazz**

Detail Adjustment →

- **Off:** Normal
- **Spatial:** Acoustic sound effect.

→ **Auto volume:**

- **Off:** Volume channel changes according to the broadcast signal.
- **On:** Volume level of the channels will stay the same, independent of the broadcast signal (e.g. in the case of advertisements).

→ **TV Speakers:**

- **Off:** Sound from external amplifier connected to the audio outputs on the rear of the TV set.
- **On:** Sound from the TV set.

• **Treble and Bass** can only be altered if "Personal" mode is selected.

• **Select Reset and press OK** to reset the sound to the factory preset levels.

• **In case of a bilingual broadcast select Dual Sound and set A for sound channel 1, B for sound channel 2 or Mono for mono channel if available. For a stereo broadcast you can choose Stereo or Mono.**

continued...

Level 1

Level 2

Level 3 / Function

SLEEP TIMER

The "Sleep Timer" option in the "Timer" menu allows you to select a time period for the TV to switch itself automatically into the standby mode.

To do that: after selecting the option press **↵**, then press **↵** or **⬅** to set the time period delay (max. of 4 hours) and finally press **OK** to store.

- While watching the TV, you can press the **⏻** button on the remote control to display the time remaining.
- One minute before the TV switches itself into standby mode, the time remaining is displayed on the TV screen automatically.

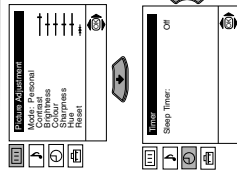

LANGUAGE / COUNTRY

The "Language/Country" option in the "Set Up" menu allows you to select the language that the menus are displayed in. It also allows you to select the country in which you wish to operate the TV set.

To do that: after selecting the option, press **↵** and then proceed in the same way as in the steps 2 and 3 of the section "Switching On the TV and Automatically Tuning".

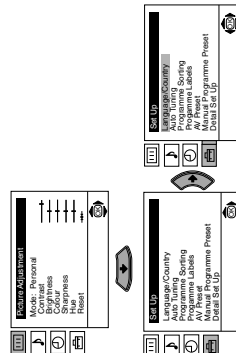

AUTO TUNING

The "Auto Tuning" option in the "Set Up" menu allows you to automatically search for and store all available TV channels.

To do that: after selecting the option, press **↵** and then proceed in the same way as in TV steps 5 and 6 of the section "Switching On the TV and Automatically Tuning".

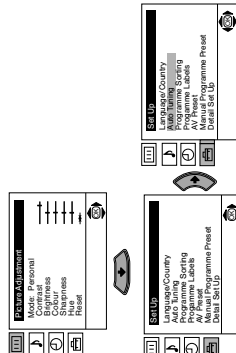

Level 1

Level 2

Level 3 / Function

PROGRAMME SORTING

The "Programme Sorting" option in the "Set Up" menu allows you to change the order in which the channels (TV Broadcast) appear on the screen.

To do that: after selecting the option, press **↵** and then proceed in the same way as in step 7 b) of the section "Switching On the TV and Automatically Tuning".

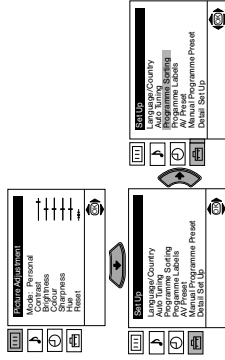

PROGRAMME LABELS

The "Programme Labels" option in the "Set Up" menu allows you to name a channel using up to five characters (letters or numbers).

To do that:

- 1 After selecting the option, press **↵** then press **↵** or **⬅** to select the programme number with the channel you wish to name.
- 2 Press **↵**. With the first element of the Label column highlighted, press **↵** or **⬅** to select a letter or number (select "-" for a blank), then press **↵** to confirm this character. Select the other four characters in the same way. Finally press **OK** to store.

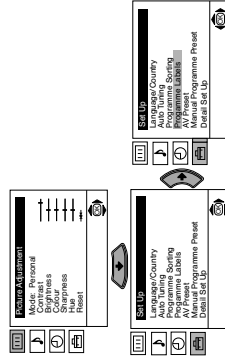

AV PRESET

The "AV Preset" option in the "Set Up" menu allows you to designate a name to the external equipment you have connected to the sockets of this TV.

To do that:

- 1 After selecting the option, press **↵** then press **↵** or **⬅** to select the input source you wish to name (AV1 and AV2 are for the rear Scarts and AV3 for front connectors). Then press **↵**.
- 2 In the label column automatically appears a label:
 - a) If you want to use one of the 6 predefined label (CABLE, GAME, CAM, DVD, VIDEO or SAT), press **↵** or **⬅** to select the desired label and finally press **OK** to store.
 - b) If you want to set a different label, select **Edit** and press **↵**. Then with the first element highlighted, press **↵** or **⬅** to select a letter, number or "-" for a blank, then press **↵** to confirm this character. Select the other four characters in the same way and finally press **OK** to store.

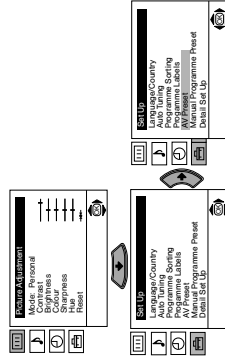

Level 1

Level 3 / Function

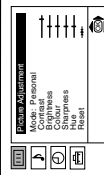

Level 2



MANUAL PROGRAMME PRESET
The "Manual Programme Preset" option in the "Set Up" menu allows you to:

a) Preset channels or a video input source one by one to the programme order of your choice. To do that:

- 1 After selecting the "Manual Programme Preset" option, press **➡** then with **Programme** option highlighted press **➡**. Press **➡** or **⬅** to select on which programme number you want to preset the channel (for VCR, select programme number "0"). Then press **⬅**.

- 2 **1** The following option is only available depending on the country you have selected in the "Language/Country" menu.

After selecting the **System** option, press **➡**. Then press **➡** or **⬅** to select the TV Broadcast system (B/G for western European countries or D/K for eastern European countries). Then press **⬅**.

- 3 After selecting the **Channel** option, press **➡**. Then press **➡** or **⬅** to select the channel tuning ("C" for terrestrial channels or "S" for cable channels). Next press **➡**. After that, press the number buttons to enter directly the channel number of the TV Broadcast or the channel of the VCR signal. If you do not know the channel number, press **➡** or **⬅** to search for it. When you tune the desired channel, press **OK** twice to store.

Repeat all the above steps to tune and store more channels.

continued...

Level 1

Level 3 / Function

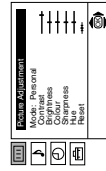

Level 2



RGB CENTRING

When connecting an RGB source, such as a "PlayStation", you may need to readjust the horizontal position of the picture. In that case, you can readjust it through the "RGB Centring" option in the "Detail Set Up".

To do that: while watching an RGB source select the "RGB Centring" option and press **➡**. Then press **➡** or **⬅** to adjust the centre of the picture between -10 and +10. Finally press **OK** to confirm and store.

PICTURE ROTATION

Because of the earth's magnetism, the picture might slant. In this case, you can correct the pictures slant by using the option "Picture Rotation" in the "Detail Set Up" menu.

To do that: after selecting the option, press **➡**. Then press **➡** or **⬅** to correct any slant of the picture between -5 and +5 and finally press **OK** to store.

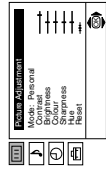

Level 2



Teletext

i Teletext is an information service transmitted by most TV stations. The index page of the teletext service (usually page 100) gives you information on how to use the service. To operate teletext, use the remote control buttons as indicated below.

A Make sure to use a channel (TV Broadcast) with a strong signal, otherwise teletext errors may occur.

To Switch On Teletext :
After select the channel (TV Broadcast) which carries the teletext you wish to view, press **⏏**.



To Select a Teletext page:

- Input 3 digits for the page number, using the numbered buttons.
- If you have made a mistake, retype the correct page number.*
- If the counter on the screen continues searching, it is because this page is not available. In that case, input another page number*

To access the next or preceding page:
Press **PROGR +** (**⏏**) or **PROGR -** (**⏏**).

To superimpose teletext on to the TV:
Whilst you are viewing teletext, press **⏏**. Press it again to cancel teletext mode.

To freeze a teletext page:
Some teletext pages have sub-pages which follow on automatically. To stop them, press **⏏** / **⏏**. Press it again to cancel the freeze.

To reveal concealed information (e.g. answer to a quiz):
Press **⏏** / **?**. Press it again to conceal the information.

To Switch Off Teletext:
Press **⏏**.

Fastext

i Fastext service lets you access pages with one button push. While you are in Teletext mode and Fastext is broadcast, a colour coded menu appears at the bottom of the teletext page. Press the colour button (red, green, yellow or blue) to access the corresponding page.

Connecting Optional Equipment

i Using the following instructions, you can connect a wide range of optional equipment to your TV set. (Connecting cables are not supplied).

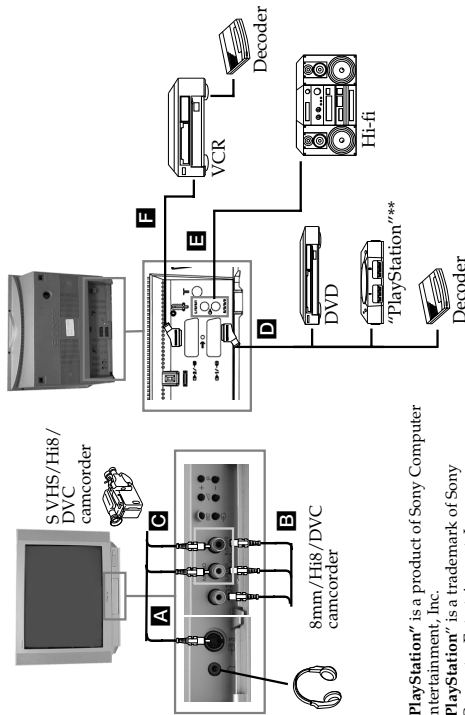

** "PlayStation" is a product of Sony Computer Entertainment, Inc.

** "PlayStation" is a trademark of Sony Computer Entertainment, Inc.

Connecting a VCR:

To connect a VCR, please refer to the section "Connecting the aerial and VCR" of this instruction manual. We recommend you connect your VCR using a scart lead. If you do not have a scart lead, tune in the VCR test signal to TV programme number "0" by using "Manual Programme Preset" option. (for details how to manual programme, see page 13, step a). Also refer to your VCR instruction manual to find out how to find the output channel of your VCR.

Connecting a VCR that supports Smartlink:

i Smartlink is a direct link between the TV set and the VCR. For more information on Smartlink, please refer to the instruction manual of your VCR. If you use a VCR that supports Smartlink, please connect the VCR by using a Scart lead to the Scart **⏏** / **⏏** **E**.

If you have connected a decoder to a VCR which supports Smartlink feature:

Select the "Manual Programme Preset" option in the "Set Up" menu and after entering in the "Decoder" option, select "On" (by using **⏏** or **⏏**). Repeat this option for each scrambling signal.

*This option is only available depending on the country you have selected in the "Country" menu. continued...

Specifications

TV system:

B/G/H, D/K

Colour system:

PAL, SECAM
NTSC 3.58, 4.43 (only Video In)

Channel Coverage:

VHF: E2-E12
UHF: E21-E69
CATV: S1-S20
HYPER: S21-S41
D/K: R1-R12, R21-R69

Picture Tube:

Flat Display FD Trinitron
KF-25FX30K: 25" (approx. 63 cm, measured diagonally)
KF-29FX30K: 29" (approx. 73 cm, measured diagonally)





Rear Terminals

 21-pin scart connector (CENELEC standard) including audio/video input, RGB input, TV audio/video output.

 21-pin Scart connector (CENELEC standard) including audio/video input, S video input, selectable audio/video output and Smartlink interface.

 audio outputs (Left/Right) - phono jacks

Front Terminals

 4 pin DIN
 video input - phono jack
 audio input - phono jacks
 headphones jack







Design and specifications are subject to change without notice.

Ecological Paper - Totally Chlorine Free 

Troubleshooting



Here are some simple solutions to the problems which may affect the picture and sound.

Problem	Solution
No picture (screen is dark) and no sound.	<ul style="list-style-type: none"> Check the aerial connection. Plug the TV in and press the  button on the front of the TV. If the standby indicator  is on, press  button on the remote control.
Poor or no picture (screen is dark), but good sound.	<ul style="list-style-type: none"> Using the menu system, select the "Picture Adjustment" menu and select "Reset" to return to the factory settings.
No picture or no menu information from equipment connected to the Scart connector.	<ul style="list-style-type: none"> Check that the optional equipment is on and press the  button repeatedly on the remote control until the correct input symbol is displayed on the screen. Press the  +/- button on the remote control. Check that "TV Speakers" is "On" on the "Sound Adjustment" menu.
Good picture, no sound.	<ul style="list-style-type: none"> Using the menu system, select the "Picture Adjustment" menu and select "Reset" to return to factory settings.
No colour on colour programmes.	<ul style="list-style-type: none"> Using the menu system, select the "Picture Adjustment" menu and select "Reset" to return to factory settings.
Distorted picture when changing programmes or selecting teletext.	<ul style="list-style-type: none"> Turn off any equipment connected to the Scart connector on the rear of the TV.
Wrong characters appear when viewing teletext.	<ul style="list-style-type: none"> Using the menu system, enter to the "Language/Country" menu and select the country in which you operate the TV set.
Picture slanted	<ul style="list-style-type: none"> Using the menu system, select the "Picture Rotation" option in the "Detail Set Up" menu to correct the picture slant.
Noisy picture when viewing a TV channel.	<ul style="list-style-type: none"> Using the menu system, select the "Manual Programme Preset" menu and adjust Fine Tuning (AFT) to obtain better picture reception. Using the menu system, select the "Noise Reduction" option in the "Detail Set Up" menu and select "On" to reduce the noise in the picture.
No unscrambling whilst viewing a scrambling channel with a decoder connected through the Scart connector  .	<ul style="list-style-type: none"> Using the menu system, select the "Set Up" menu. Then enter to "Detail Set Up" option and set "AV2 Output" to "TV".
Remote control does not function.	<ul style="list-style-type: none"> Replace the batteries.
The standby indicator  on the TV flashes.	<ul style="list-style-type: none"> Contact to your nearest Sony service centre.



In case of problems, have your TV serviced by qualified personnel. Never open the casing yourself.

SECTION 2 DISASSEMBLY

2-1. Rear Cover Removal

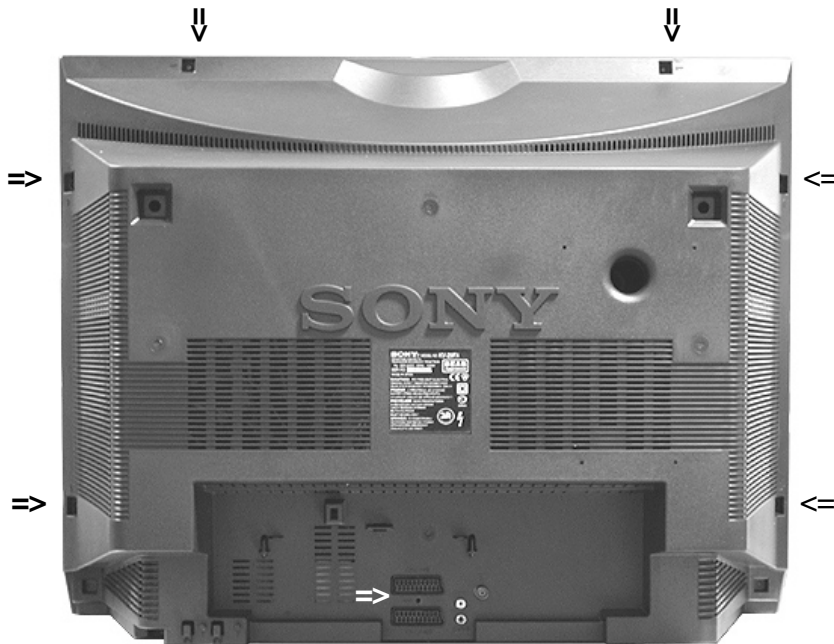

Release the mains power cable from its securing posts. Remove the rear cover fixing screws indicated. Pull the rear cover away from the front beznet.

2-2. Chassis Removal and Refitting

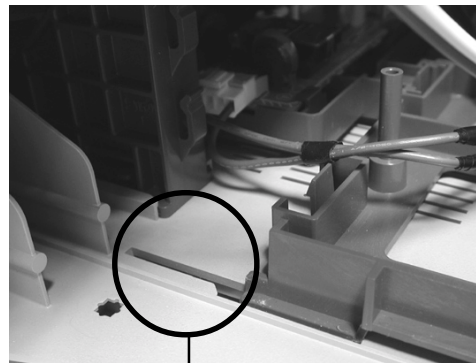
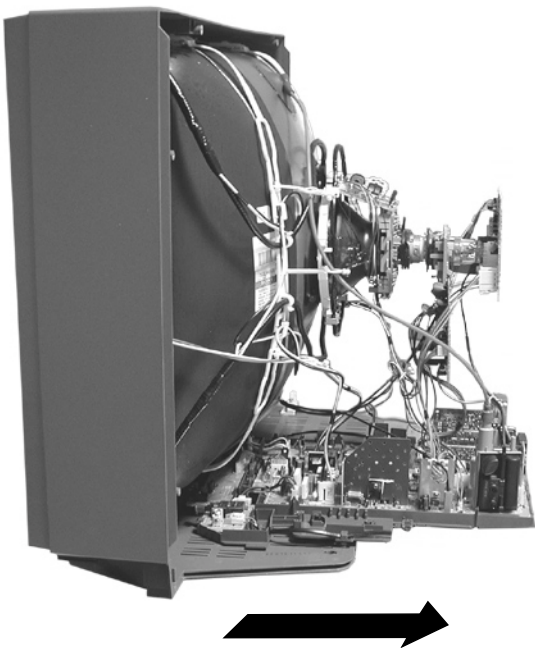

When refitting the chassis ensure that the main bracket is located in the beznet guide slots before sliding the chassis forwards. Refit the interconnecting leads in their respective purse locks.

To remove lift the main bracket rear slightly and slide the chassis away from the beznet. Ensure that the interconnecting leads are released from their purse locks to prevent damage being caused.

2-3. A Board PWB Removal [Step 1]

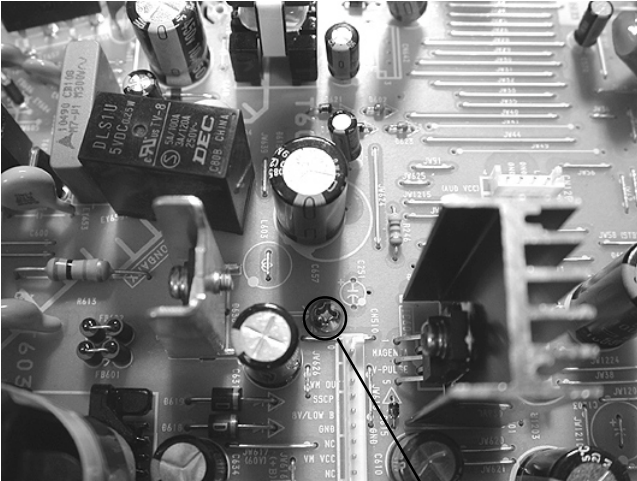

Screw.

Remove the screw securing the PWB to the main bracket.

2-4. A Board PWB Removal [Step 2]

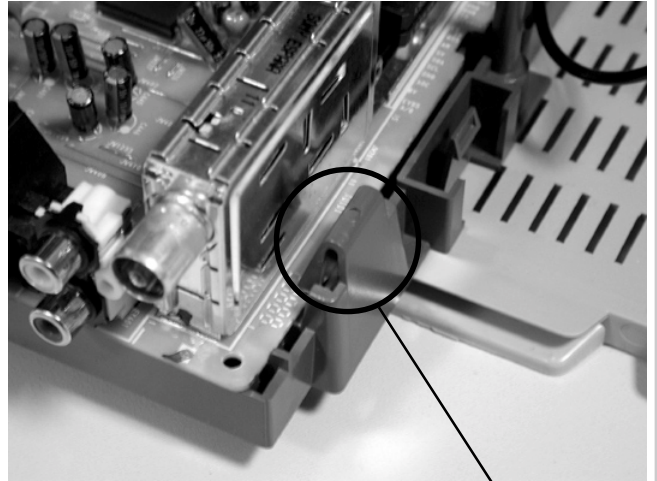

Clip.

Release the 3 securing clips located at the side of the chassis and slide the PWB clear of the bracket.

2-5. Service Position

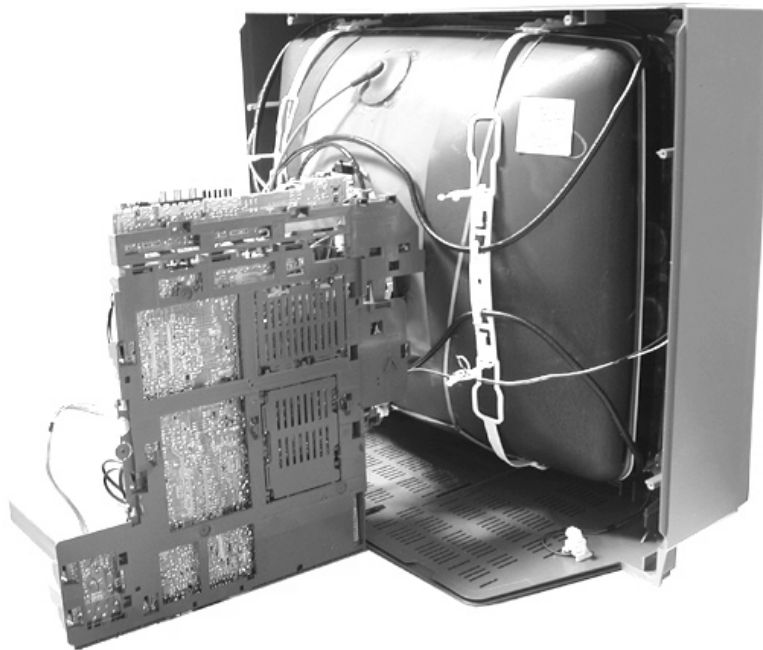

Place the chassis in the position indicated to carry out servicing. To gain access to the high voltage areas of the A Board the bottom plates need to be removed (see page 15).

2-6. Picture Tube Removal

WARNING: BEFORE REMOVING THE ANODE CAP

High voltage remains in the CRT even after the power is disconnected. To avoid electric shock, discharge CRT **before** attempting to remove the anode cap. Short between anode and CRT coated earth ground strap.

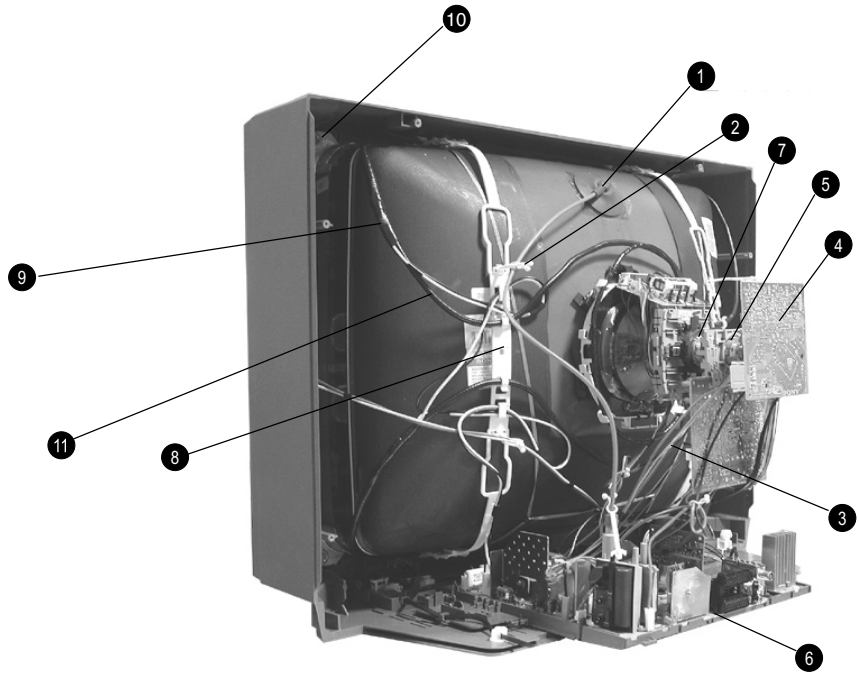
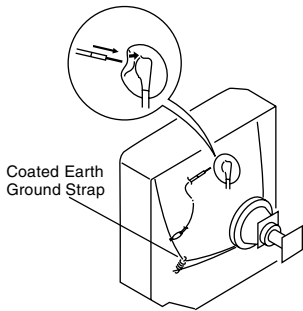

1. Discharge the anode of the CRT and remove the anode cap.
2. Release the EHT lead from its CRT support bracket.
3. Unplug all interconnecting leads from the Deflection yoke, degaussing coils, Rotation coil and CRT grounding strap.
4. Remove the C Board from the CRT.
5. Loosen the VM Block fixing screw and remove.
6. Remove the chassis assembly.
7. Loosen the Deflection yoke fixing screw and remove.
8. Remove the Degaussing Coil holders.
9. Place the set with the CRT face down on a cushion.
10. Unscrew the four CRT fixing screws [located on each CRT corner] and remove the CRT.
11. Remove the Degaussing Coils.
Remove the CRT grounding strap and spring tentioners.
[Take care not to handle the CRT by the neck.]

Removal of the Anode-Cap

* REMOVING PROCEDURES.

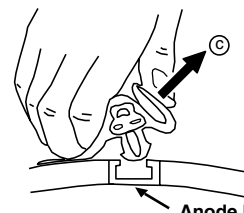
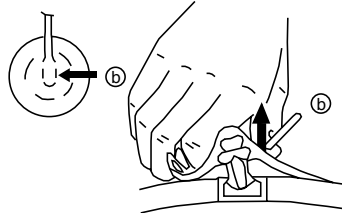
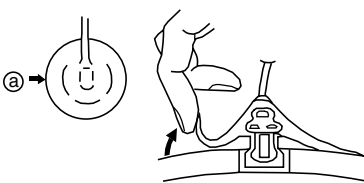

- ① Turn up one side of the rubber cap in the direction indicated by the arrow ①
- ② Using a thumb pull up the rubber cap firmly in the direction indicated by the arrow ②
- ③ When one side of the rubber cap is separated from the anode button, the anode-cap can be removed by turning up the rubber cap and pulling it up in the direction of the arrow ③

How to handle the Anode-Cap

1. To prevent damaging the surface of the anode-cap do not use sharp materials.
2. Do not apply too great a pressure on the rubber, as this may cause damage to the anode connector.
3. A metal fitting called a shatter hook terminal is fitted inside the rubber cap.
4. Do not turn the rubber foot over excessively, this may cause damage if the shatter hook sticks out.

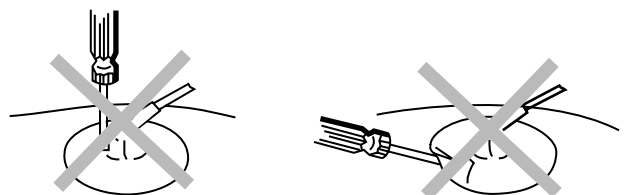

REMOVAL AND REPLACEMENT OF THE MAIN-BRACKET BOTTOM PLATES.

(1) REMOVING THE PLATES

In the event of servicing being required to the solder side of the D Board printed wiring board, the bottom plates fitted to the main chassis bracket require to be removed. This is performed by cutting the gates with a sharp wire cutter at the locations indicated by the arrows.

Note : There are 3 plates fitted to the main bracket and secured by 3 gates.

Only remove the necessary plate to gain access to the printed wiring board.

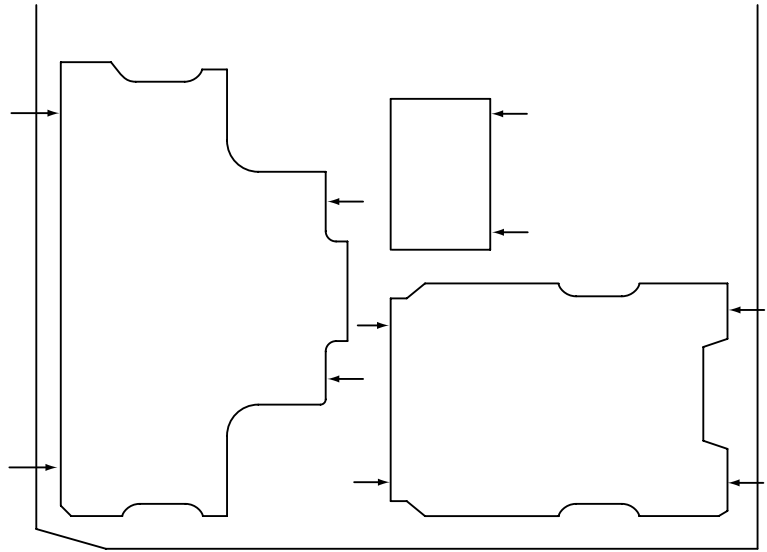

 For safety reasons, on no account should the plates be removed and not refitted after servicing.

(2) REFITTING THE PLATES

Because the plates differ in size it is important that the correct plates are refitted in their original location.

Please note that the plates need to be rotated 180 degrees from their cut position to allow the tabs to be fitted into their catch positions.

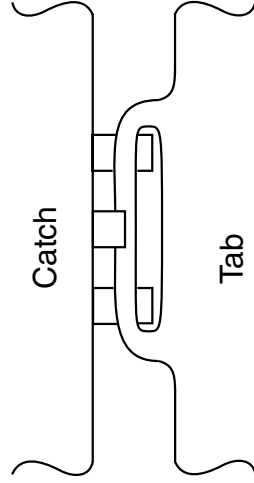

SECTION 3 SET-UP ADJUSTMENTS

- When complete readjustment is necessary or a new picture tube is installed, carry out the following adjustments.
- Unless there are specific instructions to the contrary, carry out these adjustments with the rated power supply.
- Unless there are specific instructions to the contrary, set the controls and switches to the following settings :

Contrast 80% [or remote control normal]

Brightness 50%

Carry out the adjustments in the following order :

- 3-1. Beam Landing.
- 3-2. Convergence.
- 3-3. Focus.
- 3-4. White Balance.

- Note :** Test equipment required.
1. Color bar/pattern generator.
 2. Degausser.
 3. Oscilloscope.
 4. Digital multimeter.

Preparation:

1. In order to reduce the influence of geomagnetism on the set's picture tube, face it in an easterly or westerly direction.
2. Switch on the set's power and degauss with the degausser.

3-1. Beam Landing

1. Input an all white signal from the pattern generator. Set the Contrast and Brightness to normal.
2. Set the pattern generator raster signal to Red.
3. Move the deflection yoke forward and adjust with the purity control so that the Red is at the centre and the Blue and Green take up equally sized areas on each side of the screen. [See Fig.3-1 - 3-3].
4. Move the deflection yoke backwards and adjust so that the entire screen becomes Red. [See Fig.3-1]
5. Switch the raster signal to Blue, then to Green and verify the condition.
6. When the position of the deflection yoke has been determined, fasten the deflection yoke with the screws.
7. If the beam does not land correctly in all the corners, use a magnet to correct it. [See Fig.3-4]

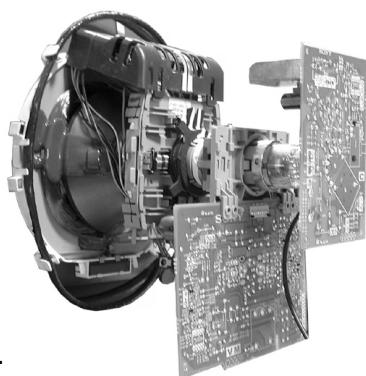

Fig. 3-1.

Caution :

High voltages are present on the Deflection yoke terminals - take care when handling the Deflection yoke whilst carrying out adjustments.

Fig. 3-2.

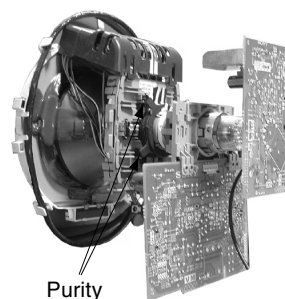

Fig. 3-3.

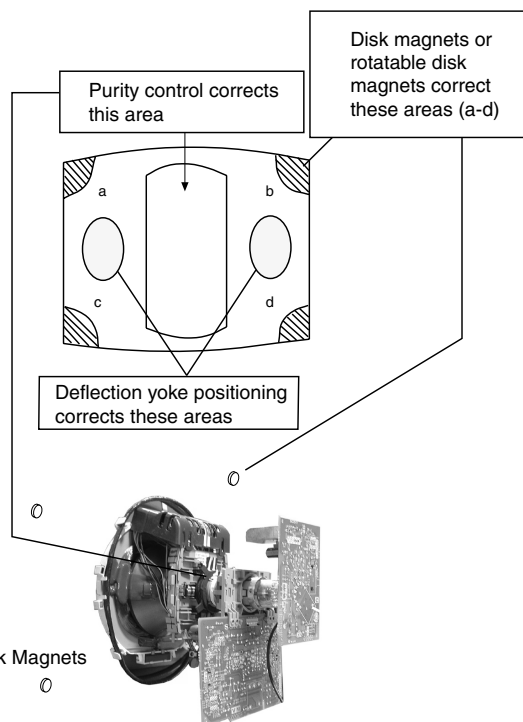
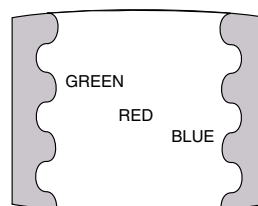

Fig.3-4

3-2. Convergence

Preparation:

- Before starting this adjustment, adjust the focus, horizontal size and vertical size.
- Minimize the Brightness setting.
- Input a dot pattern from the pattern generator.

Horizontal and Vertical Static Convergence

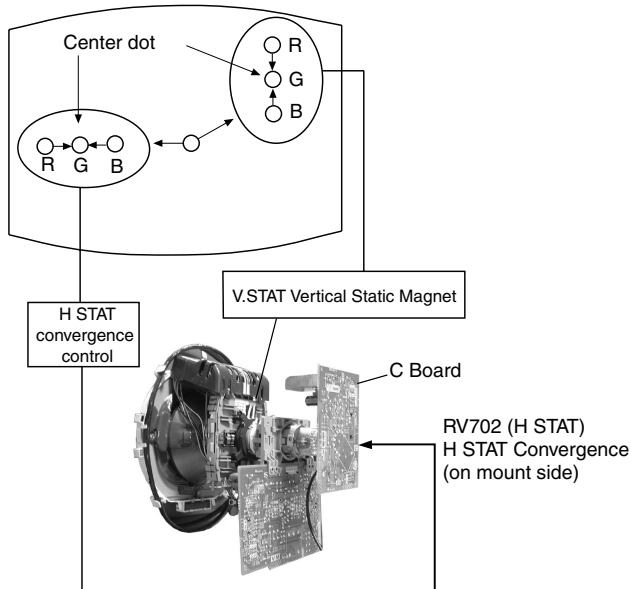
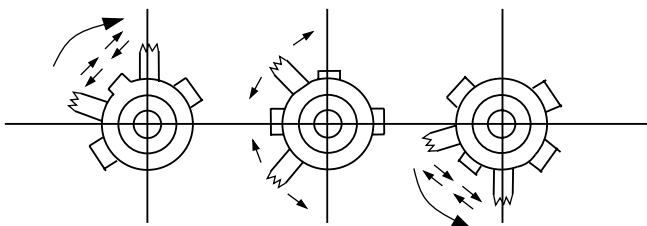

Fig.3-5

1. [Moving horizontally], adjust the H.STAT control so that the Red, Green and Blue points are on top of each other at the centre of the screen.
2. [Moving vertically], adjust the V.STAT magnet so that the Red, Green and Blue points are on top of each other at the centre of the screen.
3. If the H.STAT variable resistor is unable to bring the Red, Green and Blue points together at the centre of the screen, adjust the horizontal convergence with the H.STAT variable resistor and the V.STAT magnet in the manner indicated below.

[In this case, the H.STAT variable resistor and the V.STAT magnet influence each other].

- Tilt the V.STAT magnet and adjust the static convergence by opening or closing the V.STAT magnet.



4. If the V.STAT magnet is moved in the direction of the (a) and (b) arrows, the Red, Green and Blue points move as indicated below.

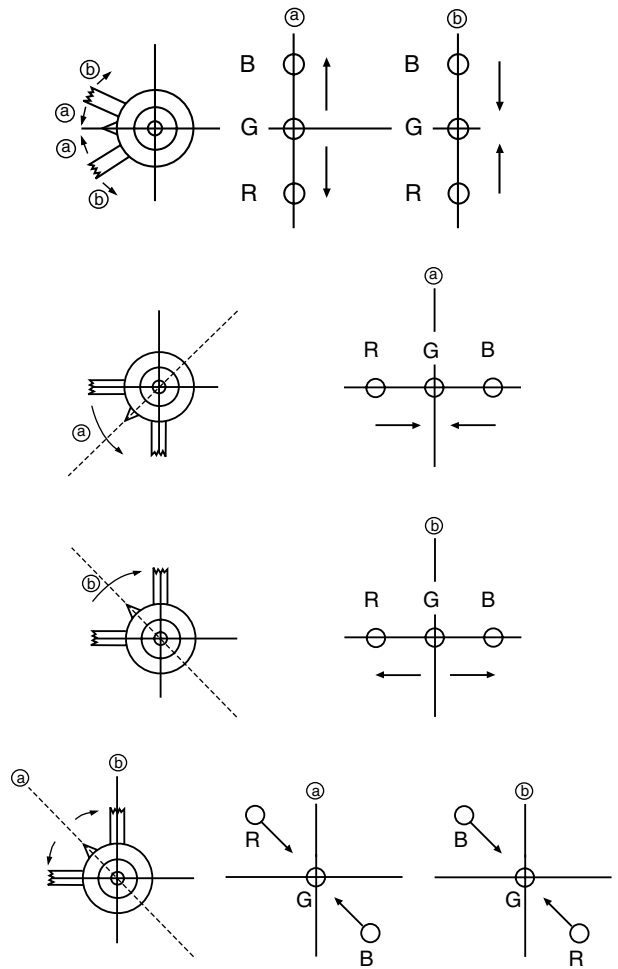

Operation of the BMC (Hexapole) magnet.

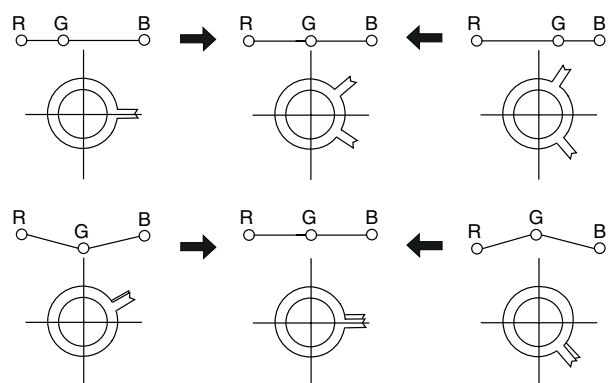

The movement of the magnets interact with each other and so the respective dot position should be monitored while carrying out this adjustment.

Use the H.STAT VR to adjust the Red, Green and Blue dots so that they coincide at the centre of the screen (by moving the dots in the horizontal direction).

Geometry Adjustment.

Preparation:

Before starting this adjustment, adjust the horizontal and vertical static convergence.

1. Remove the deflection yoke spacer.
2. Tilt the deflection yoke as indicated in the figure below and optimise the geometry.
Tilting the DY Up and Down will balance the upper and lower pin adjustment.
Tilting the DY Left and Right will balance the H-Trap adjustment.
3. Re-install the deflection yoke spacer.

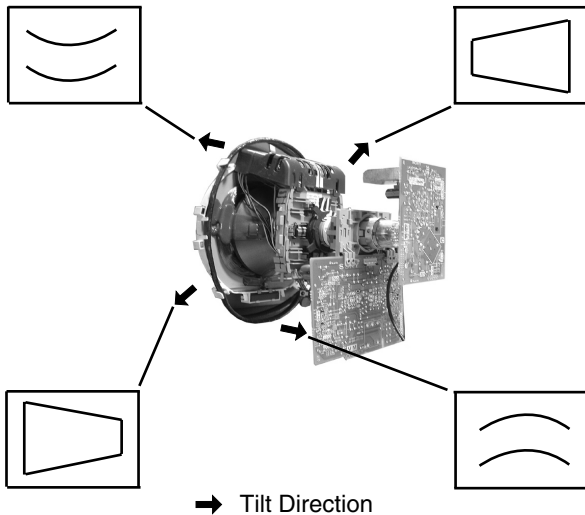

YCH Adjustment

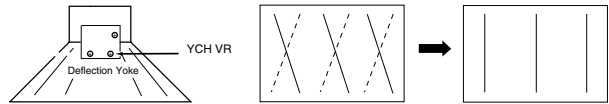

TLV Adjustment

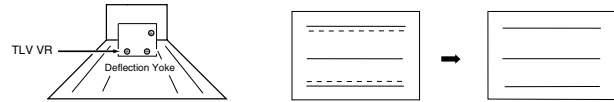

Screen Corner Convergence

If you are unable to adjust the corner convergence properly, this can be corrected with the use of permalloy magnets.

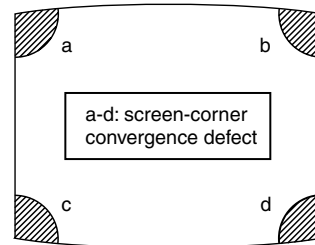

HTIL Adjustment

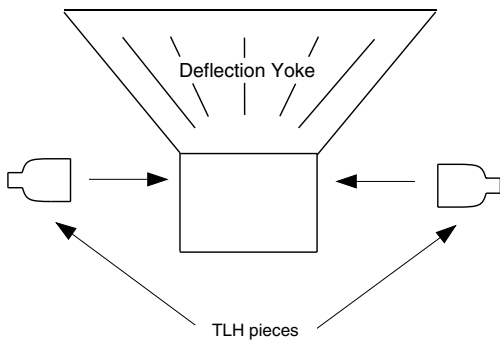

HTIL correction can be performed by adding a TLH correction assembly to the Deflection yoke.

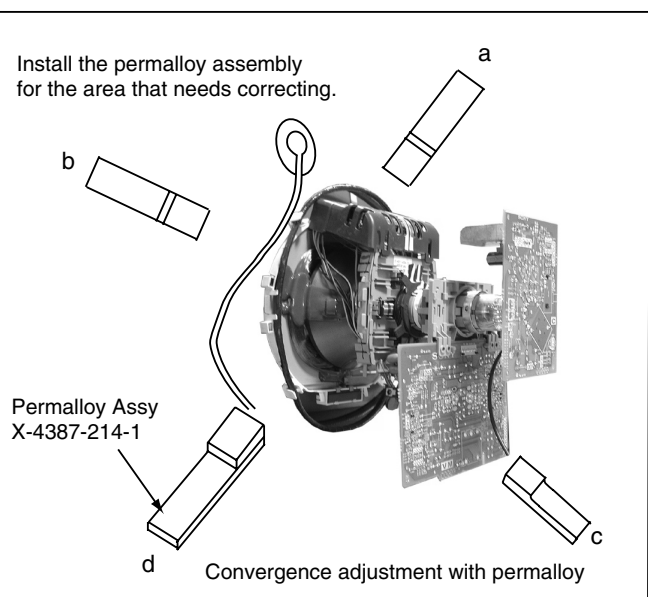
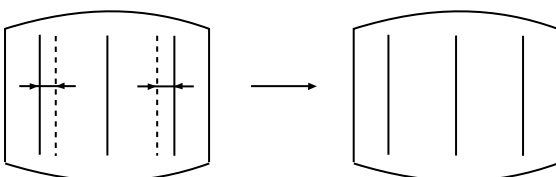

Layout of each control

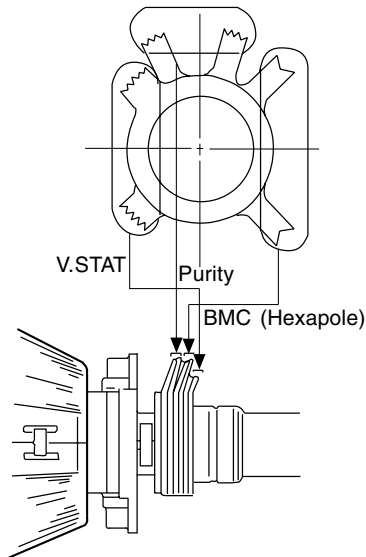

3-3. Focus Adjustment

1. Receive a television broadcast signal.
2. Normalize the picture setting.
3. Adjust the focus control located on the flyback transformer to obtain the best focus at the centre of the screen. Bring only the centre area of the screen into focus, the magenta-ring appears on the screen. In this case, adjust the focus to optimize the screen uniformly.

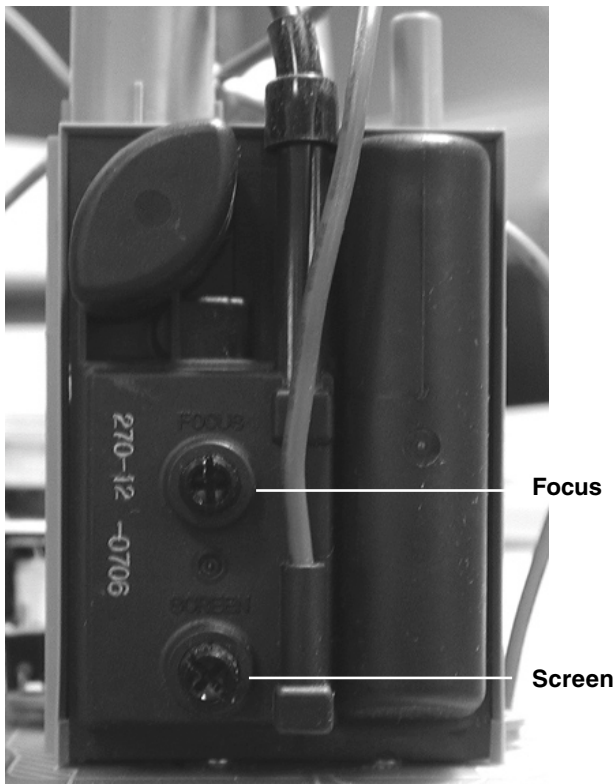

3-4. Screen (G2), White Balance

[Adjustment in the service mode using the remote commander]

G2 adjustment

1. Input a dot signal from the pattern generator.
2. Enter the 'Service Mode' by pressing 'TEST', 'TEST' and '38' (TT-38) on the remote commander, to set up the G2 service adjustment mode.
3. Whilst watching the picture, adjust the G2 control [SCREEN] located on the Flyback Transformer to the point where the OSD menu indication shows "OK".

White balance adjustment for TV mode

1. Input an all-white signal from the pattern generator.
2. Enter into the 'Service Mode' by pressing 'TEST', 'TEST' and 'MENU' on the Service Commander.
3. Select 'Service' from the on screen menu display and press the right arrow button on the remote commander.
4. The 'Service' menu will appear on the screen. [See Page 19]
5. Set the 'Contrast' to MAX.
6. Set the 'R-Drive' to 25.
7. Adjust the 'G-Drive' and the 'B-Drive' so that the white balance becomes optimum.
8. Press the 'OK' button to write the data for each item.
9. Set the 'Contrast' to MIN.
10. Adjust the 'G-Cutoff', and the 'R-Cutoff' with the left and right buttons on the remote commander so that the white balance becomes optimum.
11. Press the 'OK' button to write the data for each item.

SECTION 4 CIRCUIT ADJUSTMENTS

4-1. Electrical Adjustments

Service adjustments to this model can be performed using the supplied remote Commander RM-887.

How to enter into the Service Mode

1. Turn on the main power switch and enter into the stand-by mode.
2. Press the following sequence of buttons on the Remote Commander.

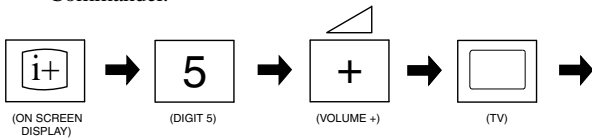

‘TT—’ will appear in the upper right corner of the screen. Other status information will also be displayed.

3. Press ‘MENU’ on the remote commander to obtain the following menu on the screen.

Geometry	
Service	
Design	
Status	
Sound	
IF adjust	
Error Menu	
FE-2 Stereo v1.30	
Factory data FFh FFh	
MSP Device : MSP3411G	

4. Move to the corresponding adjustment item using the up or down arrow buttons on the Remote Commander.
5. Press the right arrow button to enter into the required menu item.
6. Press the ‘Menu’ button on the Remote Commander to quit the Service Mode when all adjustments have been completed.

Note :

- Before performing any adjustments ensure that the correct model has been selected in the ‘Model Setting’ menu.
- After carrying out the service adjustments, to prevent the customer accessing the ‘Service Menu’ switch the TV set OFF and then ON.

ERROR MENU			
E02	OCP	(0, 255)	0
E03	OVP N/A	(0, 255)	0
E04	VSYNC	(0, 255)	0
E05	IKR	(0, 255)	0
E06	IIC	(0, 255)	0
E07	NVM	(0, 255)	0
E08	JUNGLE	(0, 255)	0
E09	TUNER	(0, 255)	0
E10	SOUNDP	(0, 255)	0
E11	8V	(0, 255)	0
WORKING TIME			
HOURS			2
MINUTES			11

SERVICE

Offset-R	(0, 63)	Adj
Offset-G	(0, 63)	Adj
R-Drive	(0, 63)	25
G-Drive	(0, 63)	Adj
B-Drive	(0, 63)	Adj
Peak-Freq	(0, 3)	0
Luma-Delay	(0, 15)	8
SC0	(0, 3)	2
White-Peak	(0, 15)	15
Subcont	(0, 15)	4
Subright	(0, 63)	31
Subcol	(0, 63)	Adj
Subsharp	(0, 63)	31
Cutoff Br.	(0, 63)	60
Br OSD	(0, 15)	10
Br TXT	(0, 15)	9

GEOMETRY

V-Linearity	(0, 63)	Adj
V-Scroll	(0, 63)	32
Left-HBlk	(0, 15)	8
Right-HBlk	(0, 15)	6
V-Angle	(0, 63)	Adj
V-Bow	(0, 63)	Adj
H-Centre	(0, 63)	Adj
H-Size	(0, 63)	Adj
Pin-Amp	(0, 63)	Adj
U-Corner-Pin	(0, 63)	Adj
L-Corner-Pin	(0, 63)	Adj
Pin Phase	(0, 63)	Adj
V-Slope	(0, 63)	35
V-Size	(0, 63)	Adj
S-Correction	(0, 63)	Adj
V-Centre	(0, 63)	Adj
V-Zoom	(0, 63)	23
Magenta	(0, 63)	40

IF ADJUST

AGC Adjust	(-16, +15)	+0
Automute		1
Audio Gain		0
L Gating		0

Sub Brightness Adjustment

1. Input a Monoscope pattern.
2. Press ‘TEST’ ‘TEST’ 13 on the Remote Commander.
3. Adjust the ‘Sub-Brightness’ data so that there is barely a difference between the 0 IRE and 10 IRE signal levels.

Sub Contrast Adjustment

1. Input a video signal that contains a small 100% white area on a black background.
2. Connect an digital voltmeter to Pin 10 of J701 [C Board].
3. Adjust the Sub-Contrast [‘TT11’] to obtain a voltage of 105 +/- 5V (KV-29FX30) or 96 +/-5V (KV-25FX30).

Sub Colour Adjustment

1. Receive a PAL colour bar signal.
2. Connect an oscilloscope to Pin 5 of CN003 [A Board].
3. Enter into the 'Service' service menu.
4. Adjust the 'Sub Colour' data so that the Cyan, Magenta and Blue colour bars are of equal levels as indicated below.

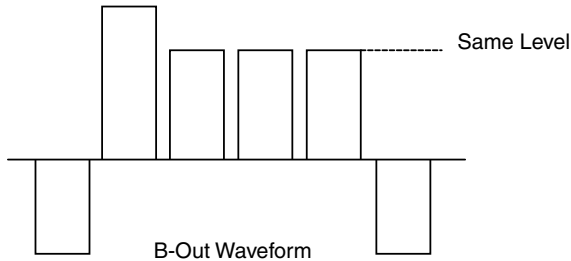

Tuner AGC Adjustment

Note:

There should be no need to adjust the AGC as this is pre-adjusted during manufacture of the FRONTEND. If the AGC does need adjustment then follow steps 1. to 4. below.

1. Receive a signal of 62dBuV / 75 ohm terminated via the tuner antenna socket.
2. Connect a voltmeter to pin1 of TU101 [print side of A Board] or to the AGC pin of CN001 [mount side of A Board].
3. Confirm that the AGC voltage is 3.5volts +/- 0.3volts.
4. If adjustment is required, then re-adjust the AGC variable resistor (located at the top rear of the FRONTEND) to obtain a voltage of 3.5V +/- 0.3V.

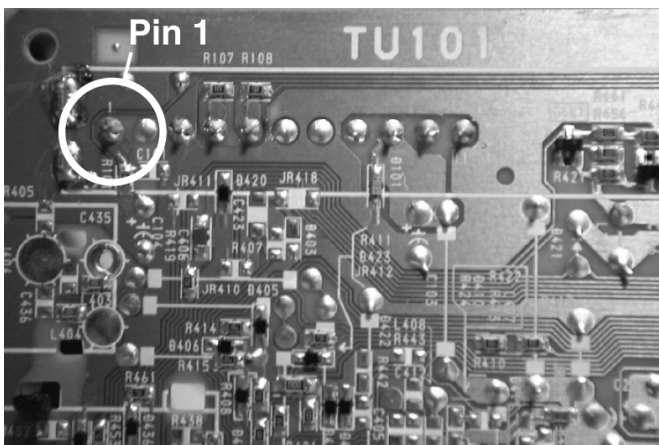

[Print side of A board]

Deflection System Adjustment

1. Enter into the 'Geometry' service menu.
2. Select and adjust each item in order to obtain the optimum image.

GEOMETRY

V-Linearity	(0, 63)	Adj
V-Scroll	(0, 63)	32
Left-HBlk	(0, 15)	8
Right-HBlk	(0, 15)	6
V-Angle	(0, 63)	Adj
V-Bow	(0, 63)	Adj
H-Centre	(0, 63)	Adj
H-Size	(0, 63)	Adj
Pin-Amp	(0, 63)	Adj
U-Corner-Pin	(0, 63)	Adj
L-Corner-Pin	(0, 63)	Adj
Pin Phase	(0, 63)	Adj
V-Slope	(0, 63)	35
V-Size	(0, 63)	Adj
S-Correction	(0, 63)	Adj
V-Centre	(0, 63)	Adj
V-Zoom	(0, 63)	23
Magenta	(0, 63)	40

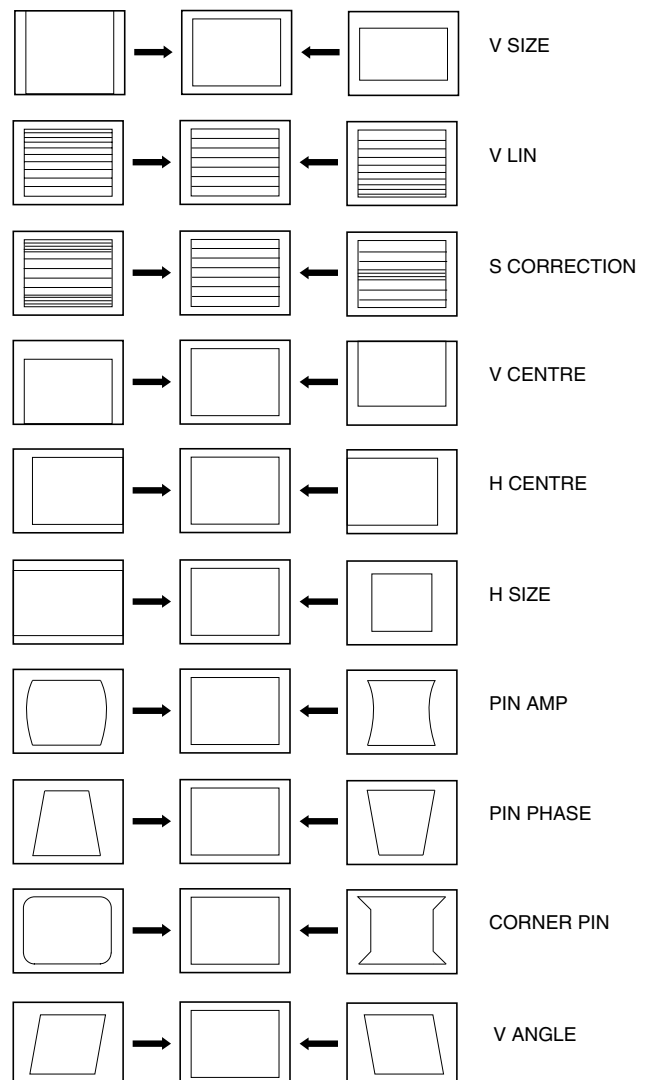

4-2. TEST MODE 1:

Test Mode 1 is available by pressing the 'TEST' button once, OSD 'T' appears. The functions described below are available by selecting the indicated keys. The 'T' is released automatically after each command is executed.

KEY	T-MODE FUNCTION
volume +	volume maximum
volume -	Picture minimum
picture +	Picture maximum
picture -	Picture minimum
colour up	colour maximum
colour down	colour minimum
brightness - bright	brightness maximum
brightness - dark	brightness minimum
hue - purplish	hue - purplish
hue - greenish	hue - greenish
sharpness - sharp	sharpness maximum
sharpness - soft	sharpness minimum
balance left	balance full left
balance right	balance full right
treble up	treble maximum
treble down	treble minimum
bass up	bass maximum
bass down	bass minimum

4-3. TEST MODE 2:

Test Mode 2 is available by pressing the 'TEST' button twice, OSD 'TT' appears. The functions described below are available by selecting the two numbers. To release the 'Test mode 2', press 00, 10, 20 ... twice or switch the TV set into Stand-by mode. In 'TT Menu' mode, it is possible to remove the Menu from the screen by pressing the Speaker Off button once. Pressing the Speaker OFF button a second time will cause the Menu to reappear. The function is kept even when the menu is not displayed on screen !!.

00	'TT' mode off
01	Picture maximum
02	Picture minimum
03	Set speaker/headphone Volume to 35%
04	Set speaker/headphone Volume to 50%
05	Set speaker/headphone Volume to 65%
06	Set speaker/headphone Volume to 80%
07	Ageing mode
08	Shipping Condition
11	Sub picture adjustment
12	Sub colour adjustment
13	Sub Brightness adjustment
14	Text H Position adjustment
15	Rotation Coil Test
16	Picture level 50%
19	Factory Mode Enable/Disable
21	Destination ADEKR
22	Destination BL
23	Destination ADEKR
24	Destination U
25	Destination ADEKR
26	Destination BL

27	Destination ADEKR
28	Destination ADEKR
31	Auto Shutoff Enable/Disable
33	Rotation ON/OFF
35	CRT 4:3 <> 16:9 ; Display TV status
36	Velocity Modulation (VM) OFF/ON test
38	G2 adjustment
41	Re-initialise NVM
43	Select Dual A sound
44	Select Dual B sound
45	Select Mono sound
46	Select Stereo sound
48	Set NVM as non virgin
49	Set NVM as virgin
51	Virtual Dolby on/off
52	Subwoofer / MPB (Bass enhancement) Enable
54	Dot structure C/M (chroma trap)ination ADEKR
55	Tuner selection (SONY/ALPS)
56	BBE enable/disable
57	BBE menu line enable/disable
61	Auto AGC Adjustment
62	AM from baseband enable/disable
63	Enable/Disable YC3 connector
64	Enable/Disable RGB priority
65	RGB auto-detect enable/disable
66	On timer enable/disable
67	Manual AGC Adjustment
68	Enable/Disable X26 countermeasure (N problem)
69	Enable/Disable ACI feature
71	Force PAL video
72	Un-force PAL (restore normal video condition)
73	Enable Zweiton D/K2 system (6.5/6.74)
74	Enable Zweiton D/K3 system (6.5/5.74)
78	Balance full left
79	Balance full right
87	Local keys test
89	Enable/Disable watchdog
91	Set 14:9 zoom mode
92	Set SMART zoom mode
93	Set 16:9 zoom mode
94	Set ZOOM mode
95	Set 4:3 zoom mode
99	Display Error and Working Time menu

5-1. BLOCK DIAGRAMS (2)

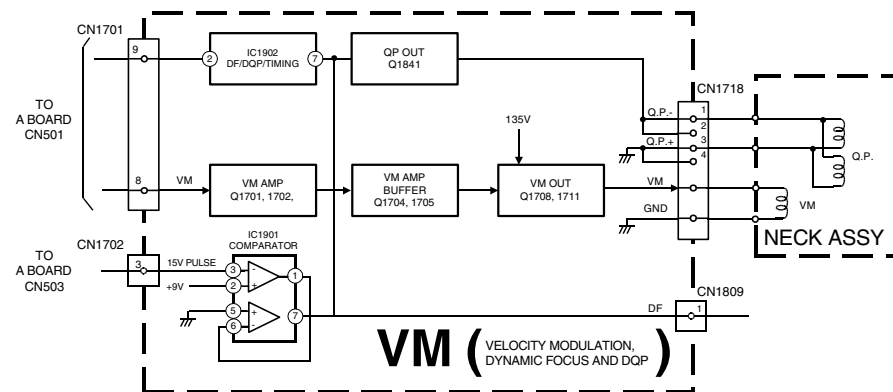
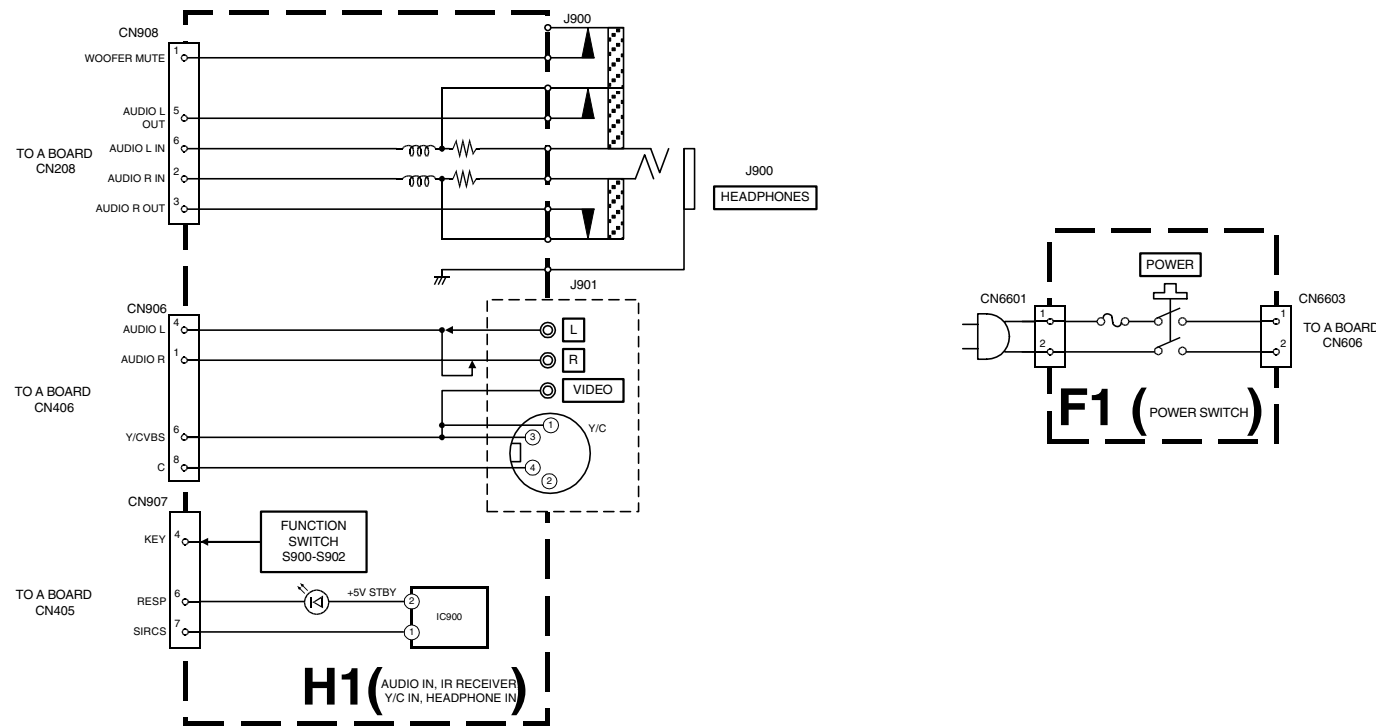
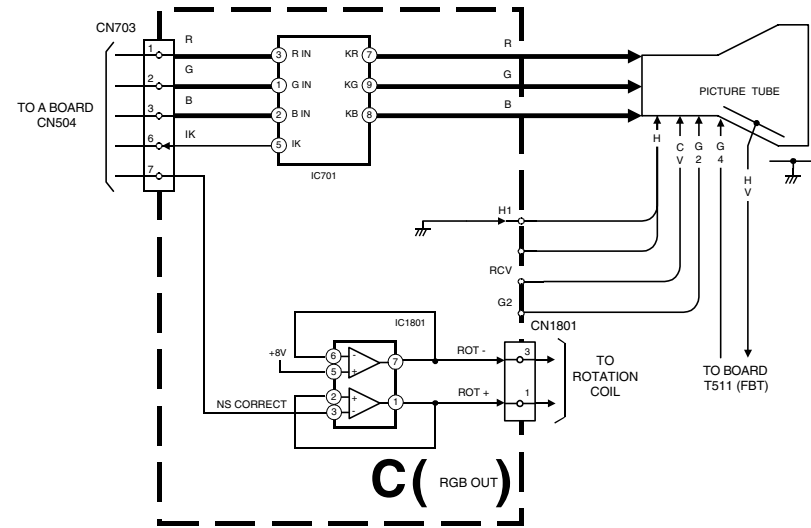

5-2. CIRCUIT BOARD LOCATION

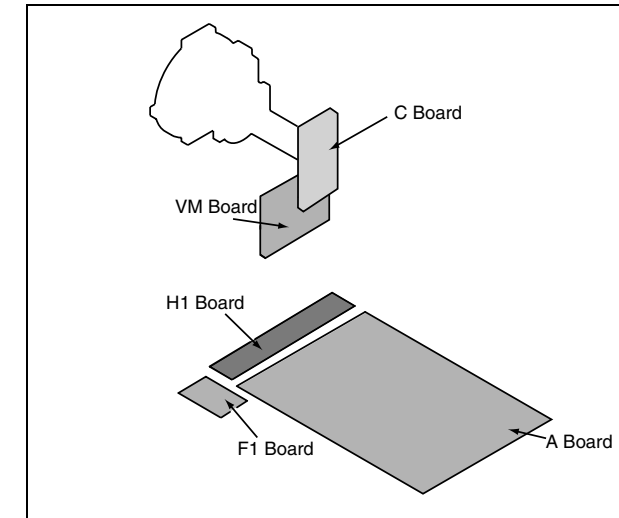

5-3. SCHEMATIC DIAGRAMS AND PRINTED WIRING BOARDS

Note :

- All capacitors are in μF unless otherwise noted.
- pF : $\mu\mu\text{F}$ 50WV or less are not indicated except for electrolytic types.
- Indication of resistance, which does not have one for rating electrical power, is as follows.

Pitch : 5mm
Electrical power rating : 1/4W

- Chip resistors are 1/10W
- All resistors are in ohms.
k = 1000 ohms, M = 1000,000 ohms

- : nonflammable resistor.
- : fusible resistor.
- : internal component.
- : panel designation or adjustment for repair.

- All variable and adjustable resistors have characteristic curve B, unless otherwise noted.
- All voltages are in Volts.
- Readings are taken with a 10Mohm digital multimeter.
- Readings are taken with a color bar input signal.
- Voltage variations may be noted due to normal production tolerances.

- : B - bus.
- : RF signal path.
- : earth - ground.
- : earth - chassis.

Reference Information

RESISTOR	RN	: METAL FILM
	RC	: SOLID
	FPRD	: NON FLAMMABLE CARBON
	FUSE	: NON FLAMMABLE FUSIBLE
	RS	: NON FLAMMABLE METAL OXIDE
	RB	: NON FLAMMABLE CEMENT
	RW	: NON FLAMMABLE WIREWOUND
		: ADJUSTMENT RESISTOR
COIL	LF-8L	: MICRO INDUCTOR
CAPACITOR	TA	: TANTALUM
	PS	: STYROL
	PP	: POLYPROPYLENE
	PT	: MYLAR
	MPS	: METALIZED POLYESTER
	MPP	: METALIZED POLYPROPYLENE
	ALB	: BIPOLAR
	ALT	: HIGH TEMPERATURE
	ALR	: HIGH RIPPLE

Note : The components identified by shading and marked Δ are critical for safety. Replace only with the part numbers specified in the parts list.

Note : Les composants identifiés par une trame et par une marque Δ sont d'une importance critique pour la sécurité. Ne les remplacer que par des pièces de numéro spécifié.

COMPONENTS MARKED AS XX ARE NOT FITTED ON THIS MODEL

VM VELOCITY MODULATION

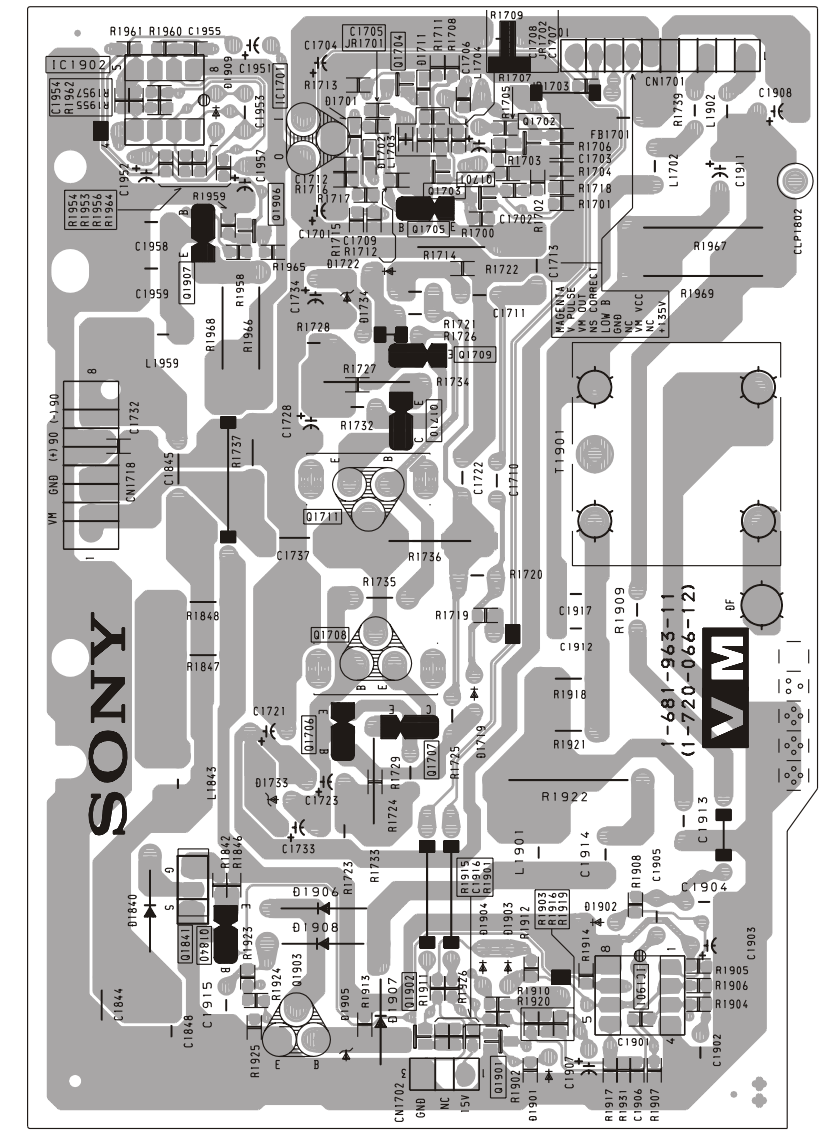
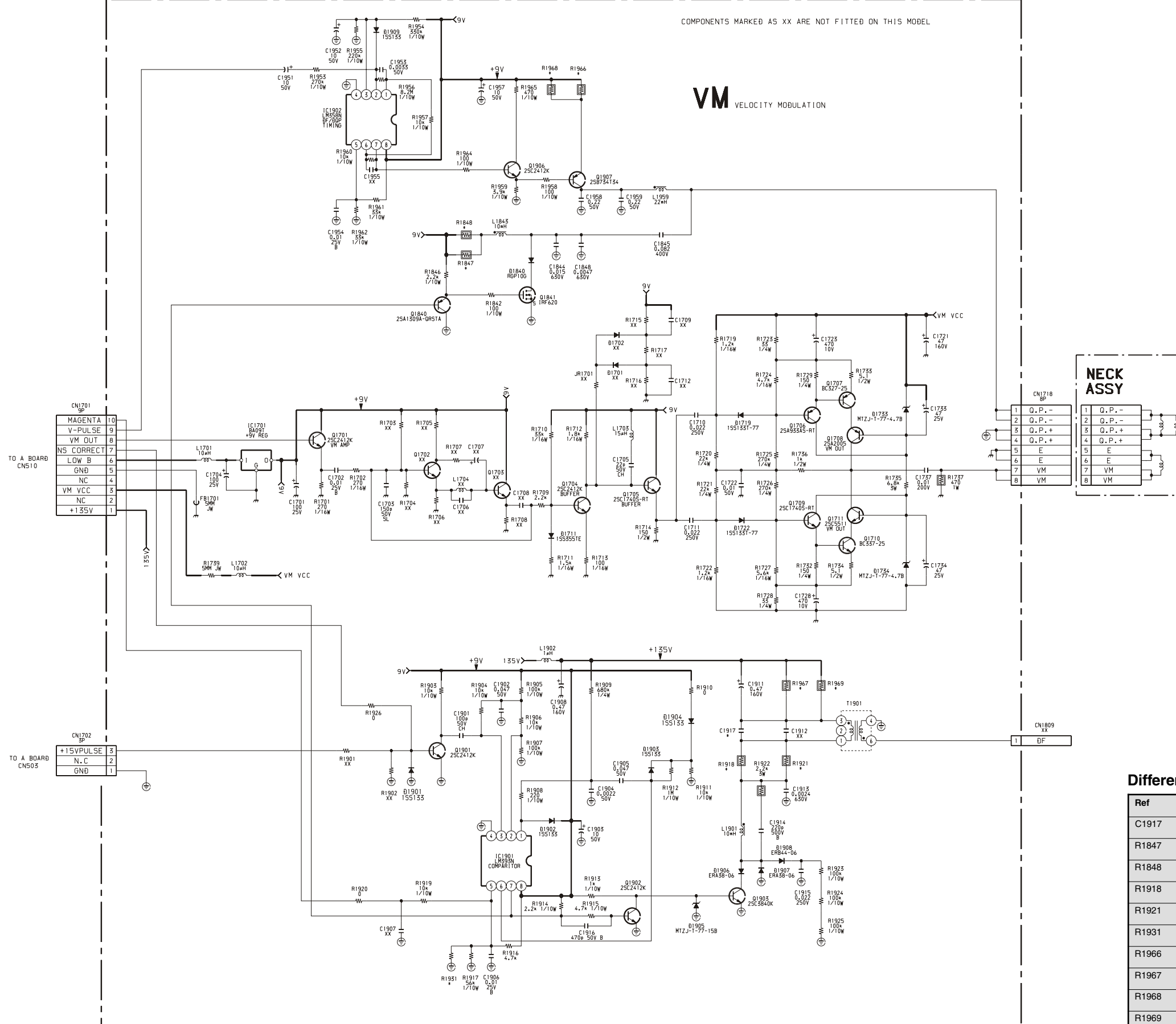

Difference Table

Ref	25FX30B	25FX30E	25FX30K	29FX30B	29FX30E	29FX30K
C1917	-	-	-	470pF	470pF	470pF
R1847	82	82	82	180	180	180
R1848	68	68	68	100	100	100
R1918	5.6K	5.6K	5.6K	6.8K	6.8K	6.8K
R1921	5.6K	5.6K	5.6K	6.8K	6.8K	6.8K
R1931	39K	39K	39K	47K	47K	47K
R1966	150	150	150	100	100	100
R1967	1K	1K	1K	6.8K	6.8K	6.8K
R1968	150	150	150	100	100	100
R1969	1K	1K	1K	5.6K	5.6K	5.6K

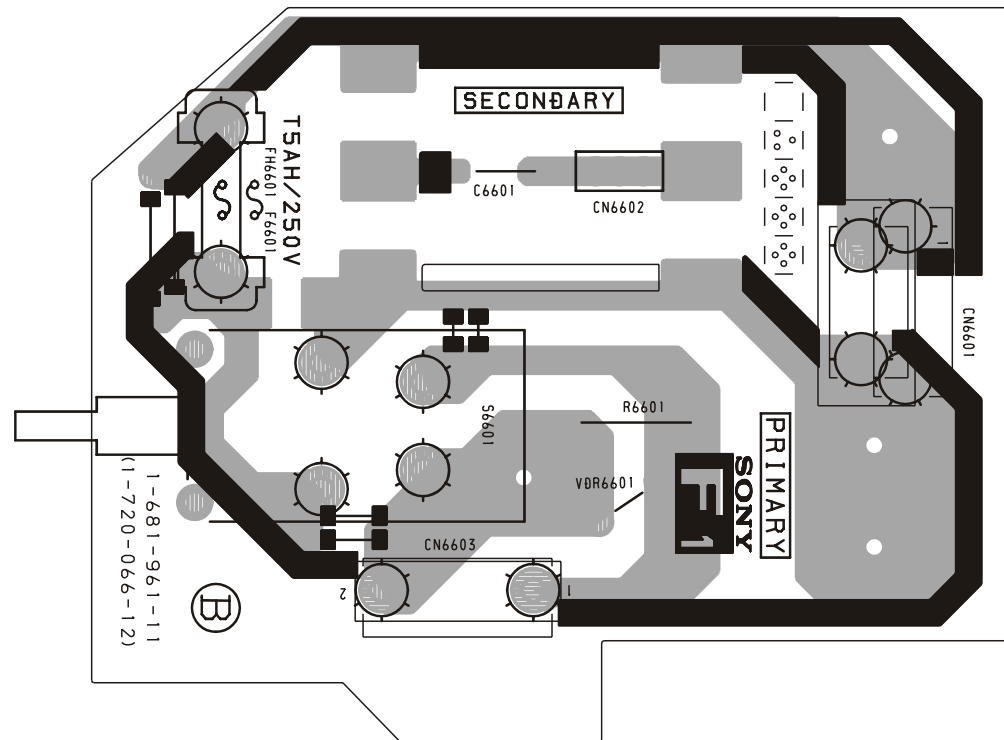
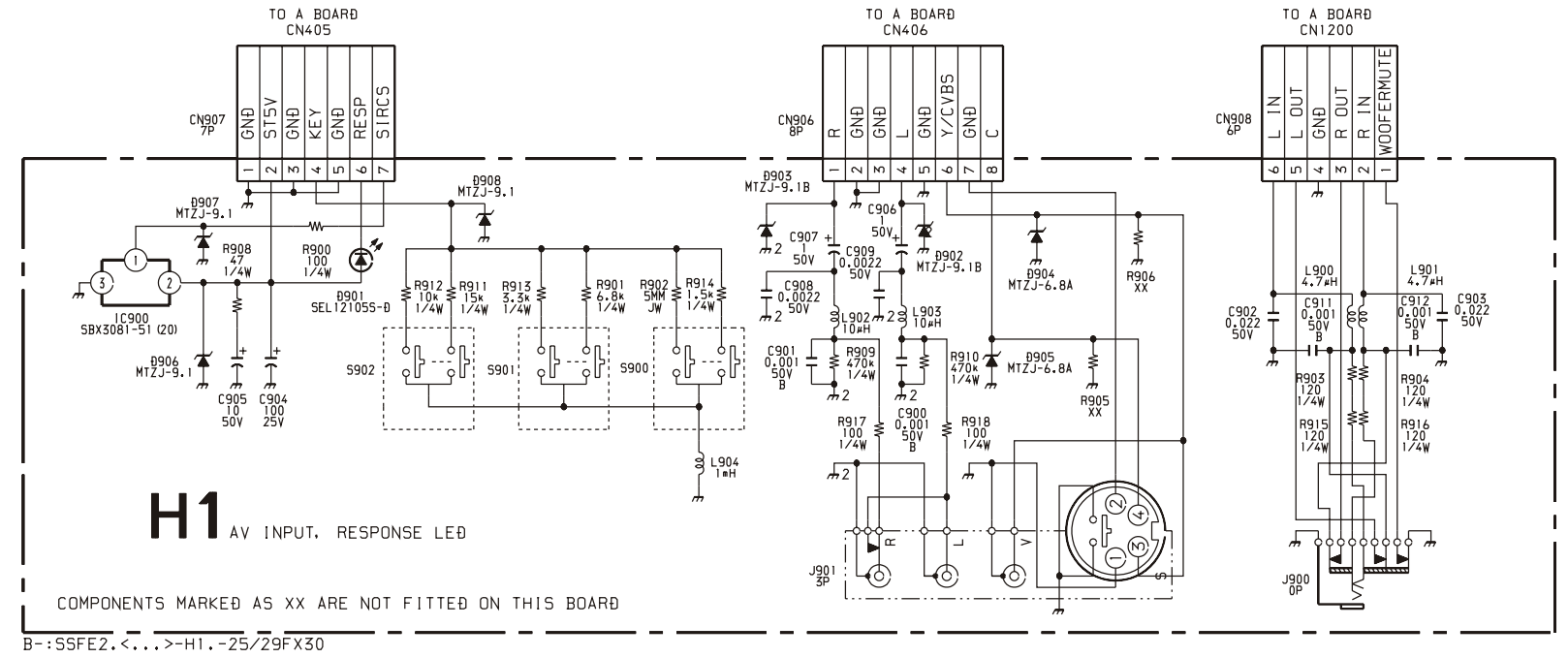
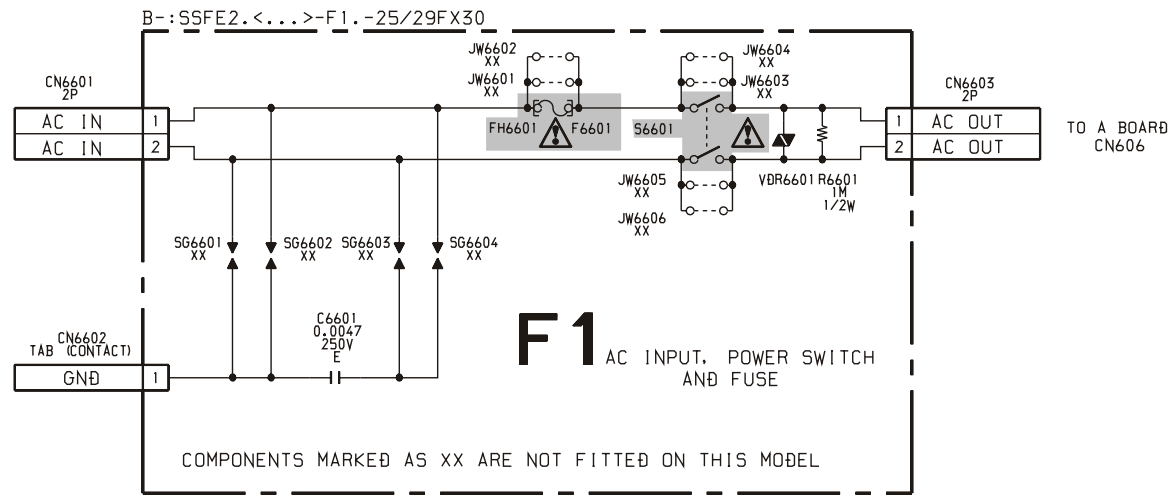

F1 [AC FILTER, FUSE, SIRCS]

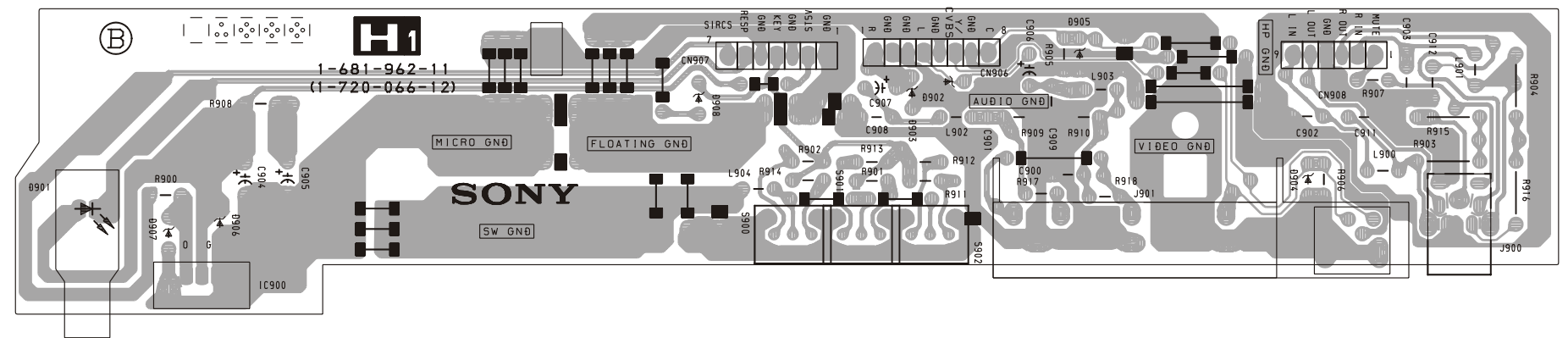

H2 [AV3 INPUT]

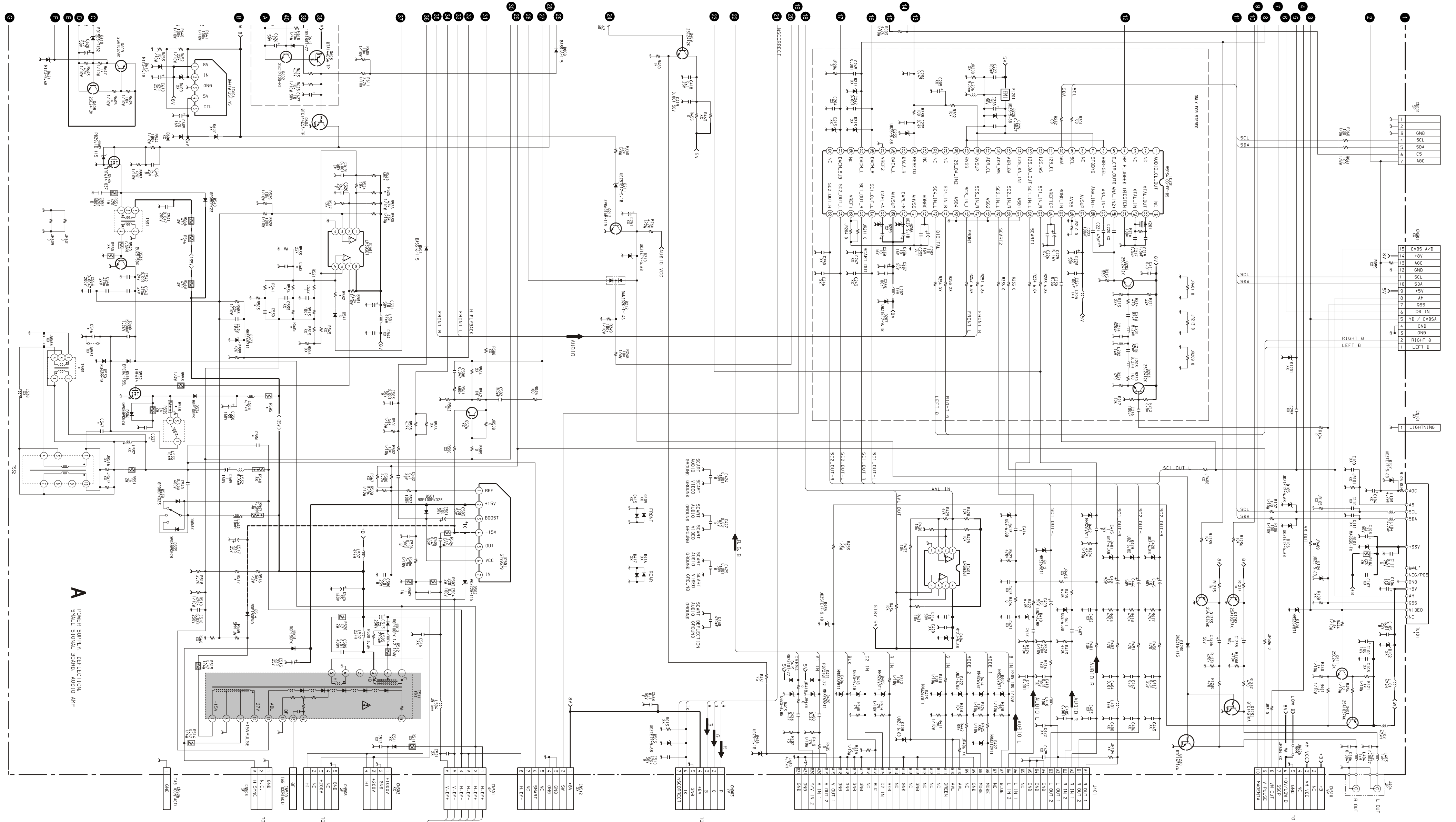

A POWER SUPPLY, DEFLECTION, SMALL SIGNAL, BOARD, AUDIO AMP

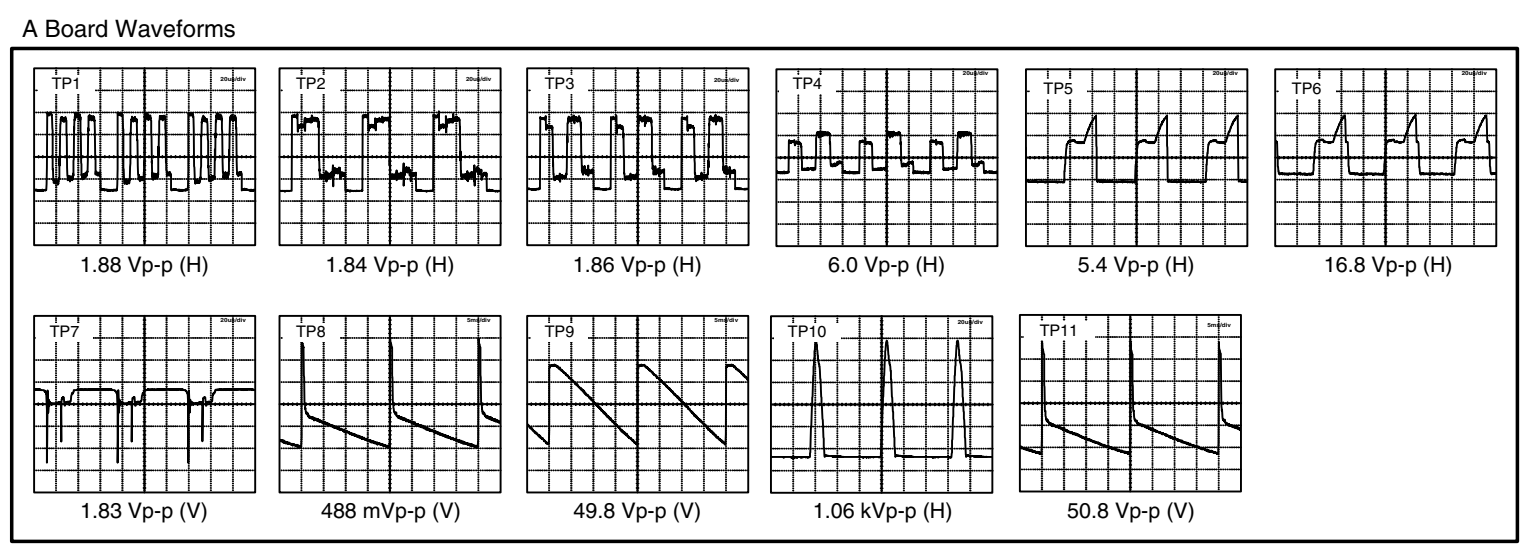

5-4. SEMICONDUCTORS

LM358N
LM393DT
LM393N
M5216P
TDA2822M
TEA2124

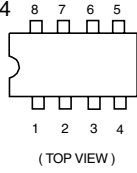

TDA9394H

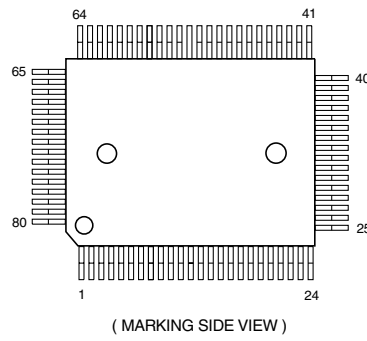

IRF614-005
IRF614-037
IRF620



MSP3410D-PP-B4

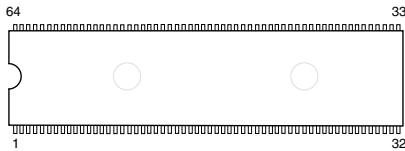

TOP209P

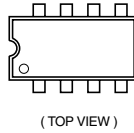

2SA933AS-QRT
2SAG33ASQT
2SA933AS-RT
2SC1740S-RT

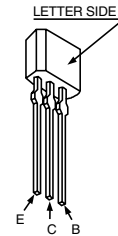

SE-135N
SE135N-LF4

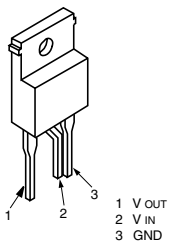

BF421-AMMO
2SA1091-O

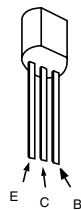

2SC2785-HFE

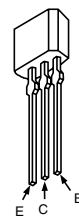

STV9379

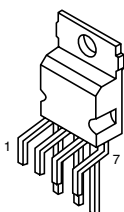

DTA144ESA
DTA144ESA-TP
DTC114EKA-T146
DTC143TKA-T146
DTC144EKA-T-146R
2SA1037K-T-146-R
R2SA1162-G
2SA1037AK-T-146-QR
2SD601A-QTX
2SC1623-L5-L6
2SC2412K-QR
2SC2412K-T-146-QR
2SC2412K-T-146-R

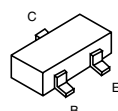

2SK2251-01-F19

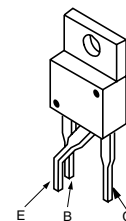

AK04-V1
 AU-01Z-V1
 BYD33G
 BYD33G-AMMO
 DINL20-TA
 DINL20-U-TA2
 DINL40-U-TR2
 ERB44-06TP1
 EGP20G
 EG-1Z-V1
 EL1Z
 ERD28-06S

ERD28-06S
 ERC06-15SL
 FMN-G12S
 GP08DPKG23
 RGP10GPKG23
 RG15GPKG23
 RG1CLF-B1
 RU-3AM
 RU3YX-LF-C4
 RU3YX-V1
 RU-4AM-T3
 1SS292T-77

ERA81-004TP1
 ERA83-006
 MTZJ-3.6A
 MTZJ-T-77-2.2A
 HZS9.INBZ
 MTZJ-T-77-3.6B
 MTZJ-T-77-4.7B
 MTZJ-T-77-5.1B
 MTZJ-T-77-5.6B
 MTZJ-T-77-6.8A
 MTZJ-T-77-8.2B
 MTZJ-T-77-7.5B
 MTZJ-T-77-9.1
 MTZJ-T-77-9.1B
 MTZJ-T-77-10

MTZJ-T-72-10A
 MTZJ-T-72-10B
 MTZJ-T-77-15B
 MTZJ-T-77-33A
 MTZJ-33C
 MTZJ-7.5B
 P6KE200ASY
 RD3.9ES-B2
 RD7.5ESB2
 RD9.1ES-B3
 RD10ESB2
 RD15ES-T1B2
 1SS119-25TD
 1SS133T-77

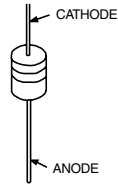
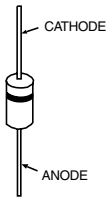

SLA-570KT3F

DAN202K
 DAN202K-T146
 MA8330-TX

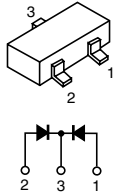
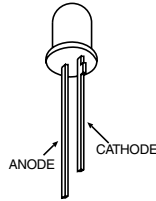

1SS355TE-17
 RD12SB2
 UDZS-TE-17-4.7B
 UDZS-TE-17-5.6B
 UDZS-TE-17-6.8B
 UDZS-TE-17-9.1B
 UDZ-TE-17-22B

D4SB60L-F

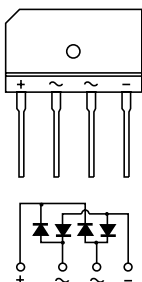
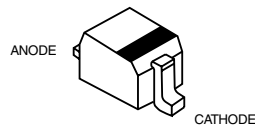

UF4005PKG23

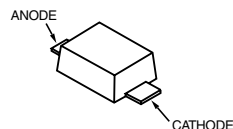

5-5 IC BLOCK DIAGRAMS

A BOARD IC604 BA41W12ST-V5

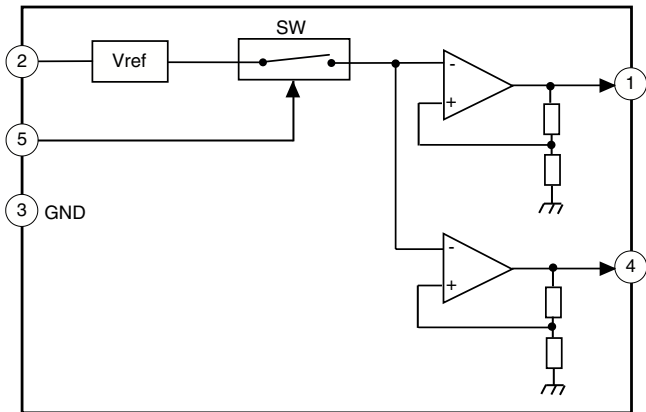

A BOARD IC401/IC531 LM393DT

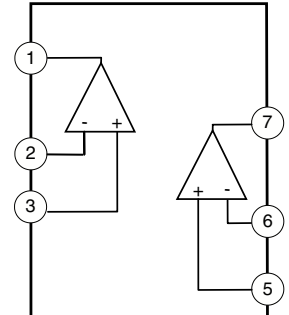

A BOARD IC601 MCZ3001D

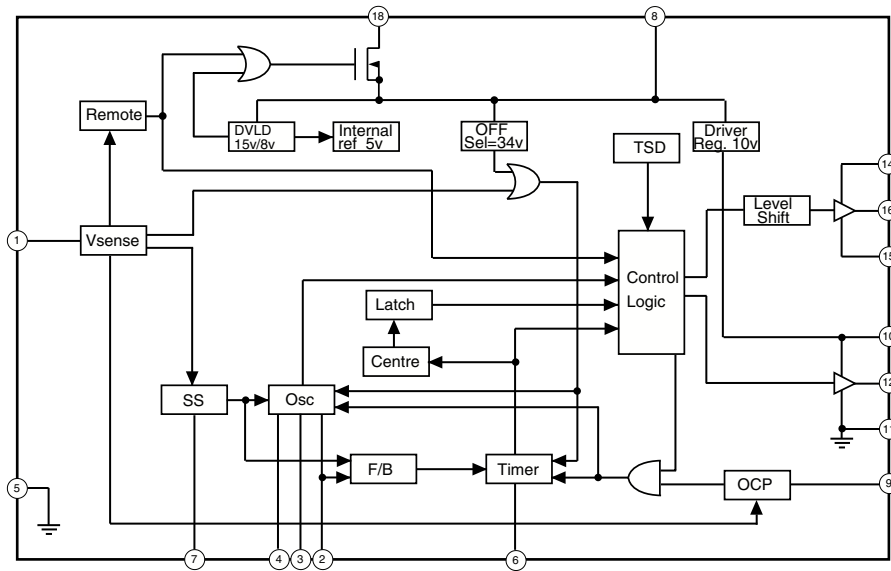

A BOARD IC1201 TDA7497

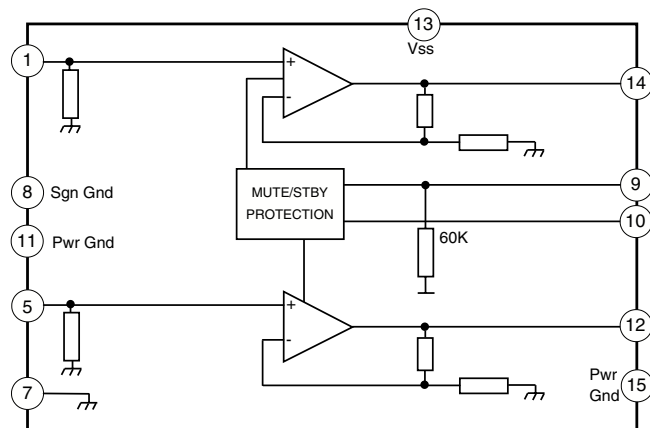

SECTION 6 EXPLODED VIEWS

NOTE :

- Items with no part number and no description are not stocked because they are seldom required for routine service.
- The construction parts of an assembled part are indicated with a collation number in the remarks column.
- Items marked “*” are not stocked since they are seldom required for routine service. Some delay should be anticipated when ordering these items.

Note : Les composants identifiés par une trame et par une marque Δ sont d'une importance critique pour la sécurité. Ne les remplacer que par des pièces du numéro spécifié.

Note : The components identified by shading and marked Δ are critical for safety. Replace only with the part numbers specified in the parts list.

6-1. CHASSIS

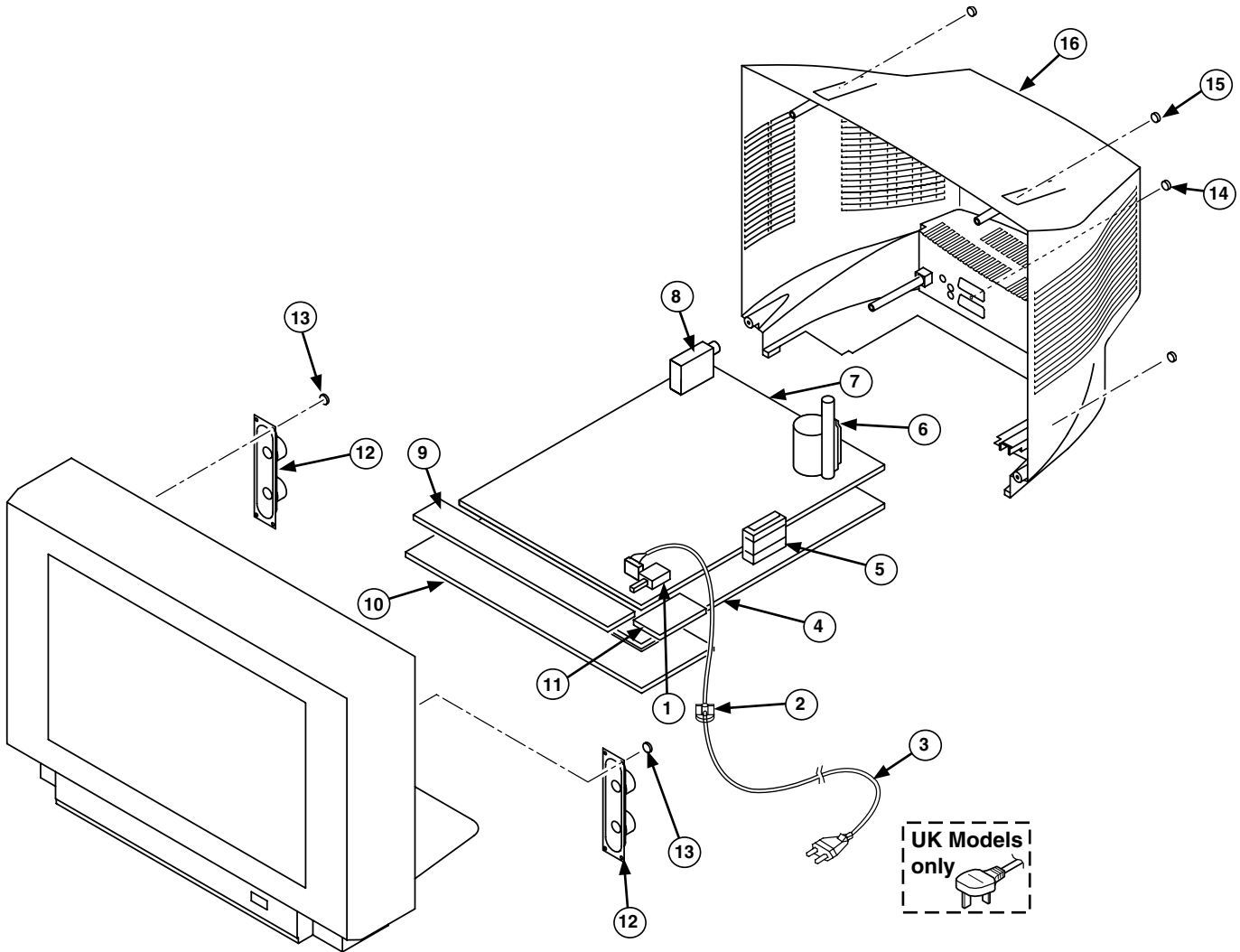

REF.NO.	PART.NO	DESCRIPTION	REMARK	REF.NO.	PART.NO	DESCRIPTION	REMARK
1	Δ 1-571-433-31	SWITCH, PUSH (AC POWER)		8	8-598-535-10	FRONTEND (BTF-EF411)	(KV-25FX30B/29FX30B)
2	*4-202-531-01	AC CORD LOCK (SC)			8-598-533-00	FRONTEND (BTF-EC411)	(KV-25FX30E/25FX30K KV-29FX30E/29FX30K)
3	Δ 1-783-083-11	CORD POWER (WITH FILTER)		9	*A-1646-240-A	H1 BOARD, COMPLETE	
4	*4-204-773-04	BRACKET, MAIN		10	4-206-017-01	BRACKET F-H	
	1-424-733-11	COIL, PFC CHOKE 65MMH		11	*A-1624-098-A	F1 BOARD, COMPLETE	
6	Δ 1-453-308-31	TRANSFORMER ASSY, FLYBACK (NX4521//Z2B4)		12	1-529-988-11	SPEAKER (4.2x24CM)	
7	*A-1632-937-A	A BOARD, COMPLETE (KV-25FX30B)		13	4-058-870-01	SCREW, (4x16) W (+) P TAPPING	
	*A-1632-924-A	A BOARD, COMPLETE (KV-25FX30E/25FX30K)		14	7-685-663-79	SCREW +BVTP 4x16 TYPE 2 IT-3	
	*A-1632-938-A	A BOARD, COMPLETE (KV-29FX30B)		15	7-685-663-71	SCREW +BVTP 4x16 TYPE 2 IT-3	
	*A-1632-923-A	A BOARD, COMPLETE (KV-29FX30E/29FX30K)		16	4-204-804-11	COVER, REAR (KV-25FX30)	
					4-204-772-11	COVER, REAR (KV-29FX30)	

6-2. PICTURE TUBE

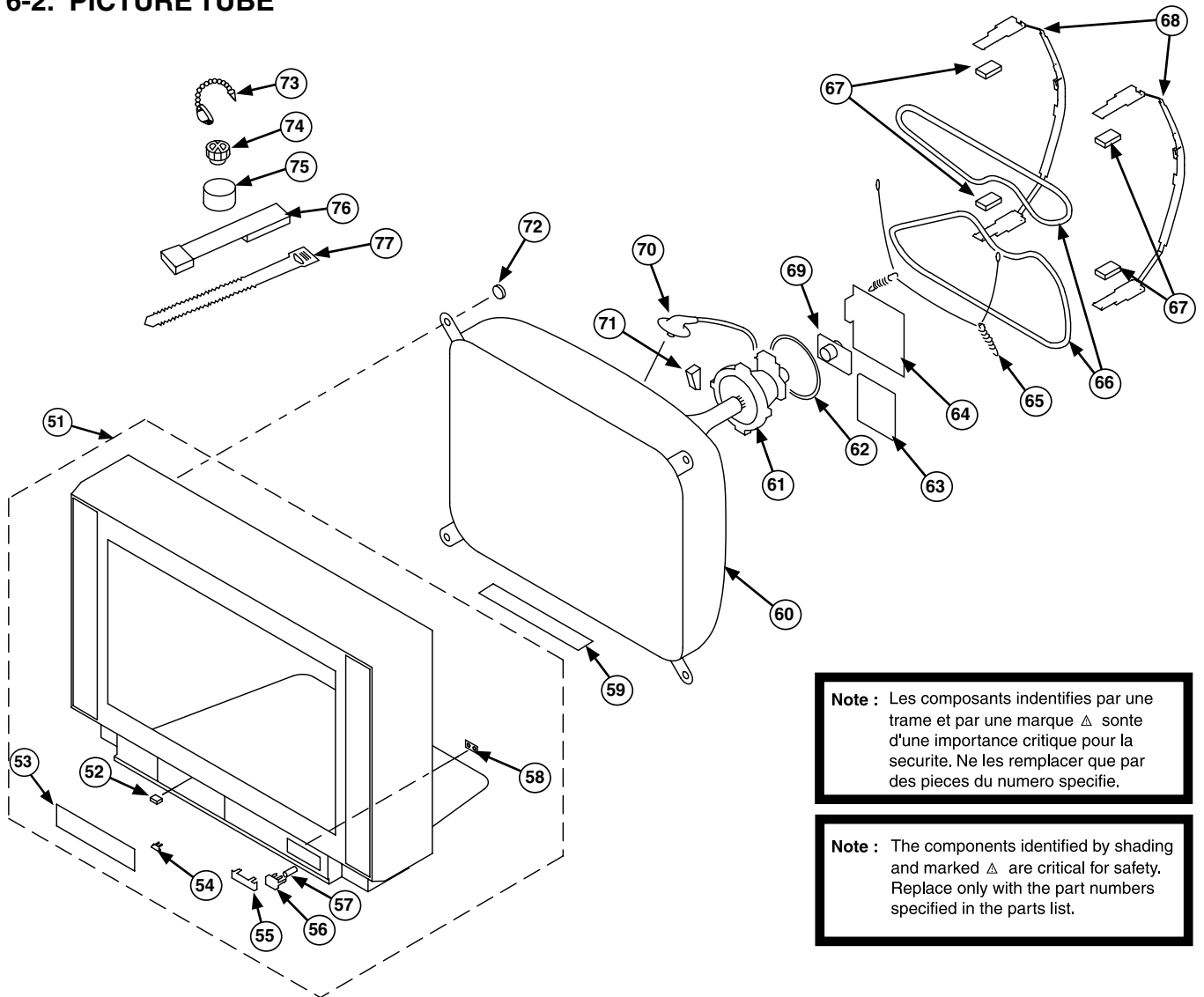

Note : Les composants indentifiés par une trame et par une marque Δ sont d'une importance critique pour la securite. Ne les remplacer que par des pieces du numero specifie.

Note : The components identified by shading and marked Δ are critical for safety. Replace only with the part numbers specified in the parts list.

REF.NO.	PART.NO	DESCRIPTION	REMARK	REF.NO.	PART.NO	DESCRIPTION	REMARK
51	X-4200-716-1	BEZNET ASSY (KV-25FX30)	52-58	64	*A-1639-021-A	C BOARD, COMPLETE	
	X-4200-715-1	BEZNET ASSY (KV-29FX30)	52-58	65	4-369-318-22	SPRING, TENSION	
52	4-072-192-02	CATCHER, PUSH		66	Δ 1-419-142-11	COIL, DEGAUSSING (KV-25FX30)	
53	4-204-770-31	DOOR, (PAINTED)			Δ 1-416-654-11	COIL, DEMAGNETIC (KV-29FX30)	
54	3-703-035-12	SHAFT LID		67	4-203-390-11	CUSHION, DGC	
55	4-204-730-21	WINDOW, ORNAMENTAL		68	*4-204-812-02	HOLDER, DGC (KV-25FX30)	
56	4-204-777-21	BUTTON, POWER			*4-204-768-01	HOLDER, DGC (KV-29FX30)	
57	4-204-426-01	SPRING		69	8-453-011-11	NECK ASSY, NA299M	
58	4-204-785-01	GUIDE, LIGHT		70	Δ 1-251-537-22	CAP ASSY, HIGH VOLTAGE	
59	4-204-865-21	SHEET, BLOTING		71	3-704-495-02	SPACER, DY	
60	Δ 8-753-250-05	PICTURE TUBE (A60LPN70X) (KV-25FX30)		72	4-046-765-12	SCREW, TAPPING 7 + CROWN WASHER	
	Δ 8-753-053-05	PICTURE TUBE (M68LNH060X) (KV-29FX30)		73	4-308-870-00	CLIP, LEAD WIRE	
61	1-451-475-11	DEFLECTION YOKE (Y25RSA) (KV-25FX30)		74	1-452-094-11	MAGNET, ROTATABLE DISK; 15MM \emptyset	
	8-451-494-51	DEFLECTION YOKE (Y29RSA-L) (KV-29FX30)		75	1-452-032-11	MAGNET, DISK; 10MM \emptyset	
62	1-452-896-11	COIL, NA ROTATION (RT-200)		76	X-4387-214-1	PERMALLOY ASSY, CORRECTION	
63	*A-1645-046-A	VM BOARD, COMPLETE (KV-25FX30)		77	3-701-007-00	BAND, BINDING	
	*A-1645-048-A	VM BOARD, COMPLETE (KV-29FX30)					

SECTION 7 ELECTRICAL PARTS LIST

PARTS LISTING TABLE OF CONTENTS

	Page
F1 BOARD COMPLETE Parts List :	Parts common to all models listed in this manual 47
A BOARD COMMON Parts List :	Parts common to all models listed in this manual 47
A BOARD VARIANT Parts List :	Parts that belong only to the model specified
Model	
<u>KV-25FX30</u> 54
<u>KV-29FX30</u> 55
C BOARD COMPLETE Parts List :	Parts common to all models listed in this manual 55
VM BOARD COMMON Parts List :	Parts common to all models listed in this manual 56
VM BOARD VARIANT Parts List :	Parts that belong only to the model specified
Model	
<u>KV-25FX30</u> 57
<u>KV-29FX30</u> 58
H1 BOARD COMPLETE Parts List :	Parts common to all models listed in this manual 58
MISCELLANEOUS : 59
ACCESSORIES AND PACKAGING MATERIALS : 59

Note : Refer to the designated variant parts list when seeking a part indicated by an asterisk (*)
Parts indicated (XX) on the Schematic Diagram are not used in this model and therefore do not appear in the Parts List.

Note : The components identified by shading and marked Δ are critical for safety. Replace only with the part numbers specified in the parts list.

F1 **A**

REF.NO.	PART.NO	DESCRIPTION	REMARK	REF.NO.	PART.NO	DESCRIPTION	REMARK
*A-1624-098-A F1 Board, Complete				C018	1-162-970-91	CERAMIC CHIP 0.01UF	10.00% 25V
	*4-374-846-01	COVER, CAPACITOR, CAP TYPE		C019	1-162-919-91	CERAMIC 22PF	5.00% 50V
	< CAPACITOR >			C020	1-164-004-91	CERAMIC CHIP 0.1UF	10.00% 25V
C6601	1-113-924-51	CERAMIC 0.0047UF	20.00% 250V	C021	1-163-037-91	CERAMIC CHIP 0.022UF	10.00% 50V
	< CONNECTOR >			C022	1-126-935-91	ELECT 470UF	20.00% 10V
CN6601	*1-580-844-11	PIN, CONNECTOR (POWER)		C025	1-126-935-91	ELECT 470UF	20.00% 16V
CN6602	1-695-915-21	TAB (CONTACT)		C026	1-162-970-91	CERAMIC CHIP 0.01UF	10.00% 25V
CN6603	*1-695-292-11	PIN, CONNECTOR (POWER)		C027	1-164-004-91	CERAMIC CHIP 0.1UF	10.00% 25V
	< FUSE >			C028	1-163-009-91	CERAMIC CHIP 0.001UF	10.00% 50V
F6601	Δ 1-576-232-31	FUSE (H.B.C.) 5A/250V		C030	1-163-009-91	CERAMIC CHIP 0.001UF	10.00% 50V
	*1-533-725-11	HOLDER, FUSE (F6601)		C033	1-163-009-91	CERAMIC CHIP 0.001UF	10.00% 50V
	< RESISTOR >			C035	1-163-009-91	CERAMIC CHIP 0.001UF	10.00% 50V
R6601	1-202-719-91	SOLID 1M 10% 1/2W		C036	1-163-009-91	CERAMIC CHIP 0.001UF	10.00% 50V
	< SWITCH >			C037	1-136-244-11	FILM 0.1UF	2.00% 50V
S6601	Δ 1-571-433-21	SWITCH, PUSH (AC POWER)		C038	1-163-038-91	CERAMIC CHIP 0.1UF	25V
	< VARISTOR >			C039	1-164-505-91	CERAMIC CHIP 2.2UF	16V
VDR6601	1-803-830-31	VARISTOR (ERZV14D621)		C040	1-163-017-91	CERAMIC CHIP 0.0047UF	10.00% 50V
*A-1632-937-A A Board, Complete (KV-25FX30B)				C042	1-162-625-91	CERAMIC CHIP 0.0047UF	5.00% 50V
*A-1632-924-A A Board, Complete (KV-25FX30E/ KV-25FX30K)				C043	1-163-037-91	CERAMIC CHIP 0.022UF	10.00% 50V
*A-1632-938-A A Board, Complete (KV-29FX30B)				C044	1-164-346-91	CERAMIC CHIP 1UF	16V
*A-1632-923-A A Board, Complete (KV-29FX30E/ KV-29FX30K)				C045	1-164-489-91	CERAMIC CHIP 0.22UF	10.00% 16V
A Board, Common Parts				C046	1-163-037-91	CERAMIC CHIP 0.022UF	10.00% 50V
	1-900-903-72	LEAD ASSY, FOCUS		C047	1-126-935-91	ELECT 470UF	20.00% 16V
	4-382-854-01	SCREW (M3X8), P, SW (+)		C053	1-164-004-91	CERAMIC CHIP 0.1UF	10.00% 25V
	4-382-854-01	SCREW (M3X8), P, SW (+)		C055	1-126-960-91	ELECT 1UF	20.00% 50V
	< CAPACITOR >			C100	1-126-933-91	ELECT 100UF	20.00% 16V
C002	1-163-233-91	CERAMIC CHIP 18PF	5.00% 50V	C103	1-126-965-91	ELECT 22UF	20.00% 50V
C004	1-163-037-91	CERAMIC CHIP 0.022UF	10.00% 50V	C105	1-162-970-91	CERAMIC CHIP 0.01UF	10.00% 25V
C005	1-126-935-91	ELECT 470UF	20.00% 10V	C106	1-126-933-91	ELECT 100UF	20.00% 16V
C006	1-163-233-91	CERAMIC CHIP 18PF	5.00% 50V	C112	1-162-970-91	CERAMIC CHIP 0.01UF	10.00% 25V
C009	1-164-004-91	CERAMIC CHIP 0.1UF	10.00% 25V	C211	1-162-970-91	CERAMIC CHIP 0.01UF	10.00% 25V
C010	1-164-005-91	CERAMIC CHIP 0.47UF	16V	C213	1-163-249-91	CERAMIC CHIP 82PF	5.00% 50V
C011	1-163-005-91	CERAMIC CHIP 470PF	10.00% 50V	C214	1-163-139-91	CERAMIC CHIP 820PF	5.00% 50V
C012	1-126-963-91	ELECT 4.7UF	20.00% 50V	C215	1-163-084-91	CERAMIC CHIP 1.5PF	0.25PF 50V
C013	1-162-970-91	CERAMIC CHIP 0.01UF	10.00% 25V	C216	1-163-117-91	CERAMIC CHIP 100PF	5.00% 50V
C014	1-162-970-91	CERAMIC CHIP 0.01UF	10.00% 25V	C217	1-163-084-91	CERAMIC CHIP 1.5PF	0.25PF 50V
C015	1-162-970-91	CERAMIC CHIP 0.01UF	10.00% 25V	C218	1-163-249-91	CERAMIC CHIP 82PF	5.00% 50V
C016	1-216-295-91	SHORT 0		C221	1-163-109-91	CERAMIC CHIP 47PF	5.00% 50V
				C222	1-163-117-91	CERAMIC CHIP 100PF	5.00% 50V
				C223	1-126-965-91	ELECT 22UF	20.00% 50V
				C224	1-163-117-91	CERAMIC CHIP 100PF	5.00% 50V
				C225	1-126-157-91	ELECT 10UF	20.00% 16V
				C226	1-164-004-91	CERAMIC CHIP 0.1UF	10.00% 25V
				C227	1-163-117-91	CERAMIC CHIP 100PF	5.00% 50V
				C228	1-126-965-91	ELECT 22UF	20.00% 50V
				C229	1-163-017-91	CERAMIC CHIP 0.0047UF	10.00% 50V
				C230	1-164-336-91	CERAMIC CHIP 0.33UF	25V
				C232	1-126-157-91	ELECT 10UF	20.00% 16V
				C233	1-164-004-91	CERAMIC CHIP 0.1UF	10.00% 25V
				C234	1-107-823-91	CERAMIC CHIP 0.47UF	10.00% 16V

A

Note : The components identified by shading and marked Δ are critical for safety. Replace only with the part numbers specified in the parts list.

REF.NO.	PART.NO	DESCRIPTION	REMARK	REF.NO.	PART.NO	DESCRIPTION	REMARK
C235	1-164-005-91	CERAMIC CHIP 0.47UF	25V	C519	1-163-275-91	CERAMIC CHIP 0.001UF	5.00% 50V
C236	1-126-157-91	ELECT 10UF	20.00% 16V	C520	1-163-038-91	CERAMIC CHIP 0.1UF	25V
C237	1-126-965-91	ELECT 22UF	20.00% 50V	C522	1-130-495-91	MYLAR 0.1UF	5.00% 50V
C238	1-163-117-91	CERAMIC CHIP 100PF	5.00% 50V	C525	1-123-024-51	ELECT 33UF	160V
C239	1-126-157-91	ELECT 10UF	20.00% 16V	C531	1-126-964-91	ELECT 10UF	20.00% 50V
C242	1-163-009-91	CERAMIC CHIP 0.001UF	10.00% 50V	C535	1-163-233-91	CERAMIC CHIP 18PF	5.00% 50V
C245	1-163-009-91	CERAMIC CHIP 0.001UF	10.00% 50V	C538	1-165-319-91	CERAMIC CHIP 0.1UF	50V
C401	1-126-964-91	ELECT 10UF	20.00% 50V	C539	1-111-230-91	ELECT 1UF	20.00% 160V
C404	1-162-970-91	CERAMIC CHIP 0.01UF	10.00% 25V	C540	1-137-051-91	FILM 0.033UF	10.00% 400V
C405	1-163-009-91	CERAMIC CHIP 0.001UF	10.00% 50V	C541	1-106-383-91	MYLAR 0.047UF	10.00% 200V
C407	1-164-346-91	CERAMIC CHIP 1UF	16V	C542	1-161-754-61	CERAMIC 0.001UF	10.00% 2KV
C408	1-127-715-91	CERAMIC CHIP 0.22UF	10% 16V	C543	1-162-134-51	CERAMIC 470PF	10.00% 2KV
C409	1-126-964-91	ELECT 10UF	20.00% 50V	C545	1-164-004-91	CERAMIC CHIP 0.1UF	10.00% 25V
C410	1-162-970-91	CERAMIC CHIP 0.01UF	10.00% 25V	C548	1-162-134-51	CERAMIC 470PF	10.00% 2KV
C411	1-163-009-91	CERAMIC CHIP 0.001UF	10.00% 50V	C550	1-107-638-91	ELECT 33UF	20.00% 160V
C412	1-164-346-91	CERAMIC CHIP 1UF	16V	C552	1-102-212-91	CERAMIC 820PF	10.00% 500V
C414	1-164-346-91	CERAMIC CHIP 1UF	16V	C553	1-137-417-91	MYLAR 0.0047UF	10.00% 200V
C415	1-164-346-91	CERAMIC CHIP 1UF	16V	C555	1-127-717-11	FILM 19000PF	3% 1.2KV
C416	1-126-964-91	ELECT 10UF	20.00% 50V	C570	1-126-961-91	ELECT 2.2UF	20.00% 50V
C417	1-162-970-91	CERAMIC CHIP 0.01UF	10.00% 25V	C580	1-162-970-91	CERAMIC CHIP 0.01UF	10.00% 25V
C418	1-164-004-91	CERAMIC CHIP 0.1UF	10.00% 25V	C582	1-163-255-91	CERAMIC CHIP 150PF	5.00% 50V
C419	1-162-964-91	CERAMIC CHIP 0.001UF	10.00% 50V	C583	1-163-009-91	CERAMIC CHIP 0.001UF	10.00% 50V
C423	1-127-715-91	CERAMIC CHIP 0.22UF	10% 16V	C600	1-119-888-51	CERAMIC 2200PF	20.00% 250V
C424	1-163-009-91	CERAMIC CHIP 0.001UF	10.00% 50V	C601	Δ 1-136-516-12	FILM 0.1UF	20.00% 300V
C426	1-163-009-91	CERAMIC CHIP 0.001UF	10.00% 50V	C602	Δ 1-136-516-12	FILM 0.1UF	20.00% 300V
C427	1-163-009-91	CERAMIC CHIP 0.001UF	10.00% 50V	C603	Δ 1-119-889-51	CERAMIC 1000PF	10.00% 250V
C428	1-163-009-91	CERAMIC CHIP 0.001UF	10.00% 50V	C604	Δ 1-119-889-51	CERAMIC 1000PF	10.00% 250V
C429	1-163-009-91	CERAMIC CHIP 0.001UF	10.00% 50V	C605	1-126-935-91	ELECT 470UF	20.00% 16V
C430	1-102-114-91	CERAMIC 470PF	10.00% 50V	C606	1-117-751-11	ELECT (BLOCK) 220UF	20.00% 450V
C435	1-163-017-91	CERAMIC CHIP 0.0047UF	10.00% 50V	C607	1-126-964-91	ELECT 10UF	20.00% 50V
C436	1-163-017-91	CERAMIC CHIP 0.0047UF	10.00% 50V	C608	1-126-963-91	ELECT 4.7UF	20.00% 50V
C437	1-164-346-91	CERAMIC CHIP 1UF	16V	C610	1-126-941-91	ELECT 470UF	20.00% 25V
C438	1-164-346-91	CERAMIC CHIP 1UF	16V	C611	1-163-009-91	CERAMIC CHIP 0.001UF	10.00% 50V
C445	1-126-964-91	ELECT 10UF	20.00% 50V	C612	1-104-571-91	CERAMIC 0.0015UF	10.00% 2KV
C446	1-126-964-91	ELECT 10UF	20.00% 50V	C613	1-104-571-91	CERAMIC 0.0015UF	10.00% 2KV
C447	1-162-970-91	CERAMIC CHIP 0.01UF	10.00% 25V	C614	1-161-964-51	CERAMIC 0.0047UF	250V
C449	1-127-715-91	CERAMIC CHIP 0.22UF	10% 16V	C615	1-115-339-91	CERAMIC CHIP 0.1UF	10.00% 50V
C501	1-126-968-91	ELECT 100UF	20.00% 50V	C616	1-165-127-91	CERAMIC 470PF	10.00% 500V
C502	1-163-038-91	CERAMIC CHIP 0.1UF	25V	C617	1-165-127-91	CERAMIC 470PF	10.00% 500V
C503	1-115-832-91	ELECT 100UF	20.00% 50V	C618	1-126-949-91	ELECT 220UF	20.00% 35V
C504	1-106-220-91	MYLAR 0.1UF	10.00% 100V	C619	1-164-644-51	CERAMIC 330PF	10.00% 500V
C505	1-137-194-81	FILM 0.47UF	5.00% 50V	C620	1-137-990-21	FILM 33000PF	3% 800V
C506	1-162-970-91	CERAMIC CHIP 0.01UF	10.00% 25V	C621	1-164-644-51	CERAMIC 330PF	10.00% 500V
C508	1-163-035-91	CERAMIC CHIP 0.047UF	50V	C622	1-104-571-91	CERAMIC 0.0015UF	10.00% 2KV
C509	1-107-364-81	MYLAR 0.01UF	10.00% 400V	C623	1-104-571-91	CERAMIC 0.0015UF	10.00% 2KV
C510	1-163-005-91	CERAMIC CHIP 470PF	10.00% 50V	C624	1-126-935-91	ELECT 470UF	20.00% 16V
C513	1-107-662-91	ELECT 22UF	20.00% 250V	C626	1-126-967-91	ELECT 47UF	20.00% 50V
C515	1-104-666-91	ELECT 220UF	20.00% 25V	C627	1-126-964-91	ELECT 10UF	20.00% 50V
C517	1-115-781-91	ELECT 220UF	20.00% 25V	C628	1-126-963-91	ELECT 4.7UF	20.00% 50V
C518	1-106-375-81	MYLAR 0.022UF	10.00% 250V	C629	1-165-127-91	CERAMIC 470PF	10.00% 500V

REF.NO.	PART.NO	DESCRIPTION	REMARK	REF.NO.	PART.NO	DESCRIPTION	REMARK
C630	1-107-641-41	ELECT	220UF	20.00%	160V		
C631	1-126-942-91	ELECT	1000UF	20.00%	25V		
C632	1-126-964-91	ELECT	10UF	20.00%	50V		
C633	1-163-009-91	CERAMIC CHIP	0.001UF	10.00%	50V		
C634	1-128-562-91	ELECT	47UF	20.00%	100V		
C635	1-136-165-81	FILM	0.1UF	5.00%	50V		
C636	1-136-479-41	FILM	0.001UF	2.00%	50V		
C637	1-126-967-91	ELECT	47UF	20.00%	50V		
C638	1-107-679-91	ELECT	10UF	20.00%	450V		
C639	1-104-665-91	ELECT	100UF	20.00%	25V		
C640	1-104-664-91	ELECT	47UF	20.00%	25V		
C641	1-115-785-91	ELECT	470UF	20.00%	16V		
C642	1-104-665-91	ELECT	100UF	20.00%	25V		
C643	1-165-127-91	CERAMIC	470PF	10.00%	500V		
C645	1-164-004-91	CERAMIC CHIP	0.1UF	10.00%	25V		
C648	1-125-782-91	CERAMIC	4700PF	10.00%	1KV		
C649	1-163-038-91	CERAMIC CHIP	0.1UF		25V		
C657	1-126-952-91	ELECT	1000UF	20.00%	35V		
C1201	1-126-972-51	ELECT	1000UF	20.00%	50V		
C1203	1-535-143-61	LEAD, JUMPER	(5.0MM)				
C1207	1-126-960-91	ELECT	1UF	20.00%	50V		
C1209	1-163-033-91	CERAMIC CHIP	0.022UF		50V		
C1210	1-126-960-91	ELECT	1UF	20.00%	50V		
C1211	1-163-033-91	CERAMIC CHIP	0.022UF		50V		
C1213	1-164-004-91	CERAMIC CHIP	0.1UF	10.00%	25V		
C1215	1-126-952-91	ELECT	1000UF	20.00%	35V		
C1218	1-109-982-91	CERAMIC CHIP	1UF	10.00%	10V		
C1219	1-104-666-91	ELECT	220UF	20.00%	25V		
C1221	1-115-339-91	CERAMIC CHIP	0.1UF	10.00%	50V		
C1228	1-126-952-91	ELECT	1000UF	20.00%	35V		
C1229	1-163-001-91	CERAMIC CHIP	220PF	10.00%	50V		
C1230	1-163-001-91	CERAMIC CHIP	220PF	10.00%	50V		
C1235	1-126-960-91	ELECT	1UF	20.00%	50V		
C1236	1-126-960-91	ELECT	1UF	20.00%	50V		
< CONNECTOR >							
CN001	*1-564-508-51	PLUG, CONNECTOR	5P				
CN003	*1-564-510-51	PLUG, CONNECTOR	7P				
CN405	*1-564-510-51	PLUG, CONNECTOR	7P				
CN406	*1-564-511-51	PLUG, CONNECTOR	8P				
CN501	1-580-798-32	CONNECTOR PIN	(DY)				
CN503	*1-564-506-51	PLUG, CONNECTOR	3P				
CN506	1-695-915-21	TAB	(CONTACT)				
CN508	*1-564-508-11	PLUG, CONNECTOR	5P				
CN509	1-695-915-21	TAB	(CONTACT)				
CN510	1-691-771-11	PLUG	(MICRO CONNECTOR) 9P				
CN602	1-508-765-13	PIN, CONNECTOR	(5MM PITCH) 3P				
CN603	*1-508-786-13	PIN, CONNECTOR	(5MM PITCH) 2P				
CN605	*1-691-960-11	PIN, CONNECTOR	(PC BOARD) 3P				
CN606	*1-695-292-11	PIN, CONNECTOR	(POWER)				
CN1200	*1-564-509-51	PLUG, CONNECTOR	6P				
CN1201	*1-564-507-51	PLUG, CONNECTOR	4P				
< DIODE >							
D001	8-719-069-55	DIODE	UDZSTE-175.6B				
D002	8-719-069-55	DIODE	UDZSTE-175.6B				
D003	8-719-109-69	DIODE	RD3.6ES-B2				
D005	8-719-929-15	DIODE	HZS9.1NB2				
D006	8-719-109-89	DIODE	RD5.6ESB2				
D007	8-719-069-55	DIODE	UDZSTE-175.6B				
D008	8-719-074-43	DIODE	BAS316-115				
D010	8-719-074-43	DIODE	BAS316-115				
D011	8-719-074-43	DIODE	BAS316-115				
D012	8-719-929-15	DIODE	HZS9.1NB2				
D013	8-719-109-69	DIODE	RD3.6ES-B2				
D014	1-216-295-11	SHORT	0				
D016	8-719-109-89	DIODE	RD5.6ESB2				
D018	8-719-109-69	DIODE	HZS9.1NB2				
D019	8-719-069-57	DIODE	UDZ-TE-17-6.8B				
D021	8-719-978-33	DIODE	DTZ-TT11-6.8B				
D022	8-719-069-55	DIODE	UDZSTE-175.6B				
D035	8-719-069-55	DIODE	UDZSTE-175.6B				
D036	8-719-069-55	DIODE	UDZSTE-175.6B				
D051	8-719-081-98	DIODE	MM3Z6V8T1				
D101	8-719-977-81	DIODE	DTZ33B				
D103	8-719-081-98	DIODE	MM3Z6V8T1				
D104	8-719-069-55	DIODE	UDZSTE-175.6B				
D105	8-719-069-55	DIODE	UDZSTE-175.6B				
D106	8-719-069-55	DIODE	UDZSTE-175.6B				
D107	8-719-069-55	DIODE	UDZSTE-175.6B				
D207	8-719-069-60	DIODE	UDZSTE-179.1B				
D210	8-719-069-55	DIODE	UDZSTE-175.6B				
D211	8-719-069-60	DIODE	UDZSTE-179.1B				
D212	8-719-914-43	DIODE	DAN202K				
D228	8-719-069-55	DIODE	UDZSTE-175.6B				
D235	8-719-069-55	DIODE	UDZSTE-175.6B				
D236	8-719-069-60	DIODE	UDZSTE-179.1B				
D401	8-719-978-33	DIODE	DTZ-TT11-6.8B				
D402	8-719-081-98	DIODE	MM3Z6V8T1				
D403	8-719-978-33	DIODE	DTZ-TT11-6.8B				
D404	8-719-109-89	DIODE	RD5.6ESB2				
D405	8-719-081-98	DIODE	MM3Z6V8T1				
D406	8-719-081-98	DIODE	MM3Z6V8T1				
D407	8-719-081-98	DIODE	MM3Z6V8T1				
D408	8-719-978-33	DIODE	DTZ-TT11-6.8B				
D410	8-719-978-33	DIODE	DTZ-TT11-6.8B				
D411	8-719-978-33	DIODE	DTZ-TT11-6.8B				
D412	8-719-081-98	DIODE	MM3Z6V8T1				
D413	8-719-978-33	DIODE	DTZ-TT11-6.8B				

A

REF.NO.	PART.NO	DESCRIPTION	REMARK	REF.NO.	PART.NO	DESCRIPTION	REMARK
D414	8-719-081-98	DIODE MM3Z6V8T1		D629	8-719-083-94	DIODE FUF4005	
D418	8-719-069-60	DIODE UDZSTE-179.1B		D631	8-719-921-63	DIODE MTZJ-7.5B	
D419	8-719-049-26	DIODE RB721Q		D632	8-719-063-70	DIODE D1NL20U	
D420	8-719-081-98	DIODE MM3Z6V8T1		D633	8-719-109-69	DIODE RD3.6ES-B2	
D421	8-719-049-26	DIODE RB721Q		D638	8-719-083-92	DIODE YG802C09RF122	
D422	8-719-978-33	DIODE DTZ-TT11-6.8B		D640	8-719-921-63	DIODE MTZJ-7.5B	
D423	8-719-081-98	DIODE MM3Z6V8T1		D649	8-719-056-83	DIODE UDZ-TE-17-6.8B	
D424	8-719-069-60	DIODE UDZSTE-179.1B		D1204	8-719-069-55	DIODE UDZSTE-175.6B	
D427	8-719-082-01	DIODE MM3Z12VT1		D1205	8-719-081-90	DIODE PDZ22B-115	
D428	8-719-978-33	DIODE DTZ-TT11-6.8B		D1230	8-719-074-43	DIODE BAS316-115	
D429	8-719-978-33	DIODE DTZ-TT11-6.8B				< FERRITE BEAD >	
D435	8-719-069-60	DIODE UDZSTE-179.1B		FB601	1-410-397-31	FERRITE	1.1UH
D436	8-719-069-60	DIODE UDZSTE-179.1B		FB602	1-410-397-31	FERRITE	1.1UH
D501	8-719-979-85	DIODE EGP20G		FB604	1-410-397-31	FERRITE	1.1UH
D502	8-719-081-90	DIODE PDZ22B-115		FB605	1-410-397-31	FERRITE	1.1UH
D503	8-719-069-55	DIODE UDZSTE-175.6B		FB606	1-412-911-21	FERRITE	0UH
D504	8-719-074-43	DIODE BAS316-115				< FILTER >	
D506	8-719-908-03	DIODE GP08D		FB607	1-412-911-21	FERRITE	0UH
D507	8-719-070-59	DIODE PDZ6.8B-115				< IC >	
D512	8-719-302-43	DIODE EL1Z		FL201	1-239-803-21	FILTER, EMI	
D513	8-719-979-85	DIODE EGP20G				< IC >	
D514	8-719-979-85	DIODE EGP20G		IC001	6-800-338-01	IC TDA9394H/N1/4/0334	
D534	8-719-302-43	DIODE EL1Z		IC004	8-759-575-72	IC M24C08-WM6T	
D535	8-719-908-03	DIODE GP08D		IC201	6-700-373-01	IC MSP3410G-PP-B9	
D536	8-719-945-80	DIODE ERC06-15S		IC401	8-759-665-11	IC LM393DT	
D537	8-719-070-62	DIODE PDZ9.1B-115		IC501	8-759-192-71	IC STV9379	
D538	8-719-908-03	DIODE GP08D		IC531	8-759-665-11	IC LM393DT	
D539	8-719-312-10	DIODE RU4AM-T3		IC601	8-759-670-30	IC MCZ3001D	
D540	8-719-908-03	DIODE GP08D		IC602	8-749-016-19	IC SE135N-LF4	
D541	1-216-295-91	SHORT 0		IC604	8-759-668-87	IC BA41W12ST-V5	
D573	8-719-082-00	DIODE MM3Z4V7T1		IC608	8-759-591-02	IC L78L33ABZ-AP	
D601	8-719-510-53	DIODE D4SB60L		IC609	8-759-468-89	IC TOP209P	
D602	8-719-911-19	DIODE 1SS119-25		IC1201	8-759-831-57	IC TDA7495S	
D604	8-719-083-94	DIODE FUF4005				< JACK >	
D608	8-719-063-70	DIODE D1NL20U		J401	1-766-296-21	CONNECTOR, DUAL SCART	
D610	8-719-110-41	DIODE RD15ES-B2		J404	1-784-632-11	JACK, PIN 2P	
D611	8-719-991-33	DIODE 1SS133T-77				< COIL >	
D612	8-719-991-33	DIODE 1SS133T-77		L001	1-408-611-21	INDUCTOR	47UH
D613	8-719-911-19	DIODE 1SS119-25		L002	1-414-938-21	INDUCTOR	47UH
D614	8-719-077-76	DIODE D2SB60A-F04		L004	1-408-611-21	INDUCTOR	47UH
D615	8-719-929-15	DIODE HZS9.1NB2		L006	1-408-611-21	INDUCTOR	47UH
D618	8-719-022-97	DIODE D2S4MF		L027	1-216-295-91	SHORT	0
D619	8-719-022-97	DIODE D2S4MF		L101	1-412-533-41	INDUCTOR	47UH
D620	8-719-109-85	DIODE RD5.1ESB2		L102	1-408-611-21	INDUCTOR	47UH
D621	8-719-109-89	DIODE RD5.6ESB2		L103	1-412-002-41	INDUCTOR	4.7UH
D623	8-719-911-19	DIODE 1SS119-25					
D624	8-719-063-70	DIODE D1NL20U					
D625	8-719-062-39	DIODE D4SBL20UF1					
D627	8-719-063-70	DIODE D1NL20U					
D628	8-719-083-49	DIODE P6KE200ASY					

Note : The components identified by shading and marked Δ are critical for safety. Replace only with the part numbers specified in the parts list.

A

REF.NO.	PART.NO	DESCRIPTION	REMARK	REF.NO.	PART.NO	DESCRIPTION	REMARK
L104	1-412-002-41	INDUCTOR	4.7UH	Q533	8-729-049-08	TRANSISTOR BU2515DX-127	
L201	1-408-602-21	INDUCTOR	8.2UH	Q535	8-729-053-33	TRANSISTOR IRF614-037	
L202	1-408-591-21	INDUCTOR	1UH	Q570	8-729-120-28	TRANSISTOR 2SC1623-L5L6	
L203	1-408-602-21	INDUCTOR	8.2UH	Q601	8-729-026-49	TRANSISTOR 2SA1037AK-T146	
L205	1-408-591-21	INDUCTOR	1UH	Q602	8-729-119-78	TRANSISTOR 2SC2785-HFE	
L206	1-535-143-61	LEAD, JUMPER	(5.0MM)	Q603	8-729-029-56	TRANSISTOR DTA144ESA	
L207	1-408-591-21	INDUCTOR	1UH	Q604	8-729-030-02	TRANSISTOR DTC144ESA	
L401	1-410-993-42	INDUCTOR	1UH	Q606	8-729-053-36	TRANSISTOR 2SK2640-01MR	
L403	1-410-993-42	INDUCTOR	1UH	Q607	8-729-053-36	TRANSISTOR 2SK2640-01MR	
L404	1-410-993-42	INDUCTOR	1UH	Q608	8-729-120-28	TRANSISTOR 2SC1623-L5L6	
L405	1-535-143-61	LEAD, JUMPER	(5.0MM)	Q609	8-729-026-49	TRANSISTOR 2SA1037AK-T146	
L406	1-535-143-61	LEAD, JUMPER	(5.0MM)	Q1210	8-729-120-28	TRANSISTOR 2SC1623-L5L6	
L410	1-216-025-91	RES-CHIP	100 5% 1/10W	Q1211	8-729-120-28	TRANSISTOR 2SC1623-L5L6	
L430	1-412-002-41	INDUCTOR	4.7UH	Q1230	8-729-027-56	TRANSISTOR DTC143TKA-T146	
L446	1-216-295-91	SHORT	0	Q1231	8-729-027-56	TRANSISTOR DTC143TKA-T146	
L448	1-216-295-91	SHORT	0	Q1232	8-729-026-49	TRANSISTOR 2SA1037AK-T146	
L501	1-414-187-31	INDUCTOR	47UH	Q1233	8-729-026-49	TRANSISTOR 2SA1037AK-T146	
L502	1-412-529-41	INDUCTOR	22UH			< RESISTOR >	
L503	1-412-521-41	INDUCTOR	4.7UH	JR3	1-216-296-91	SHORT	0
L504	1-535-143-61	LEAD, JUMPER	(5.0MM)	JR4	1-216-295-91	SHORT	0
L505	1-412-542-41	INDUCTOR	270UH	JR5	1-216-295-91	SHORT	0
L507	1-412-533-41	INDUCTOR	47UH	JR7	1-216-295-91	SHORT	0
L532	1-412-553-41	INDUCTOR	3.3MH	JR9	1-216-295-91	SHORT	0
L533	1-406-989-11	INDUCTOR	10MH	JR10	1-216-295-91	SHORT	0
L535	1-459-111-21	INDUCTOR	10MH	JR16	1-216-296-91	SHORT	0
L601	1-408-603-21	INDUCTOR	10UH	JR17	1-216-295-91	SHORT	0
L602	1-408-611-21	INDUCTOR	47UH	JR21	1-216-818-91	RES-CHIP	560 5% 1/10W
L603	1-535-143-61	LEAD, JUMPER	(5.0MM)	JR24	1-216-295-91	SHORT	0
L1201	1-535-143-61	LEAD, JUMPER	(5.0MM)	JR25	1-216-295-91	SHORT	0
L1203	1-535-143-61	LEAD, JUMPER	(5.0MM)	JR26	1-216-295-91	SHORT	0
		< PHOTO COUPLER >		JR204	1-216-296-91	SHORT	0
PH601	Δ 8-749-016-21	IC TCET1103G		JR206	1-216-296-91	SHORT	0
		< IC LINK >		JR209	1-216-295-91	SHORT	0
PS1201	1-533-597-31	LINK, IC		JR210	1-216-295-91	SHORT	0
		< TRANSISTOR >		JR211	1-216-296-91	SHORT	0
Q002	8-729-027-56	TRANSISTOR DTC143TKA-T146		JR213	1-216-295-91	SHORT	0
Q013	8-729-120-28	TRANSISTOR 2SC1623-L5L6		JR401	1-216-295-91	SHORT	0
Q014	8-729-120-28	TRANSISTOR 2SC1623-L5L6		JR409	1-216-295-91	SHORT	0
Q049	8-729-120-28	TRANSISTOR 2SC1623-L5L6		JR418	1-216-296-91	SHORT	0
Q202	8-729-120-28	TRANSISTOR 2SC1623-L5L6		JR419	1-216-295-91	SHORT	0
Q203	8-729-120-28	TRANSISTOR 2SC1623-L5L6		JR423	1-216-296-91	SHORT	0
Q212	8-729-422-33	TRANSISTOR 2SD601A-Q-TX		JR506	1-216-296-91	SHORT	0
Q401	8-729-026-49	TRANSISTOR 2SA1037AK-T146		JR508	1-216-296-91	SHORT	0
Q409	8-729-120-28	TRANSISTOR 2SC1623-L5L6		JR601	1-216-295-91	SHORT	0
Q411	8-729-120-28	TRANSISTOR 2SC1623-L5L6		JR609	1-216-295-91	SHORT	0
Q532	8-729-053-33	TRANSISTOR IRF614-037		JR610	1-216-296-91	SHORT	0
				JR1209	1-216-295-91	SHORT	0
				R001	1-216-295-91	SHORT	0

A

REF.NO.	PART.NO	DESCRIPTION	REMARK	REF.NO.	PART.NO	DESCRIPTION	REMARK
R003	1-216-065-91	RES-CHIP	4.7K 5% 1/10W	R072	1-216-295-91	SHORT	0
R004	1-216-033-91	RES-CHIP	220 5% 1/10W	R074	1-216-073-91	RES-CHIP	10K 5% 1/10W
R005	1-216-041-91	RES-CHIP	470 5% 1/10W	R090	1-216-057-91	RES-CHIP	2.2K 5% 1/10W
R006	1-216-025-91	RES-CHIP	100 5% 1/10W	R092	1-216-073-91	RES-CHIP	10K 5% 1/10W
R007	1-216-025-91	RES-CHIP	100 5% 1/10W	R094	1-216-025-91	RES-CHIP	100 5% 1/10W
R008	1-216-025-91	RES-CHIP	100 5% 1/10W	R095	1-216-065-91	RES-CHIP	4.7K 5% 1/10W
R009	1-216-049-91	RES-CHIP	1K 5% 1/10W	R096	1-216-073-91	RES-CHIP	10K 5% 1/10W
R010	1-216-049-91	RES-CHIP	1K 5% 1/10W	R101	1-216-093-91	RES-CHIP	68K 5% 1/10W
R011	1-216-295-91	SHORT	0	R102	1-216-097-91	RES-CHIP	100K 5% 1/10W
R012	1-216-121-91	RES-CHIP	1M 5% 1/10W	R103	1-216-210-91	RES-CHIP	3.3K 5% 1/8W
R014	1-216-069-91	RES-CHIP	6.8K 5% 1/10W	R104	1-216-295-91	SHORT	0
R015	1-216-198-91	RES-CHIP	1K 5% 1/8W	R105	1-414-813-91	FERRITE	0UH
R017	1-216-025-91	RES-CHIP	100 5% 1/10W	R106	1-215-900-91	METAL OXIDE	22K 5% 2W
R018	1-208-820-91	METAL CHIP	39K 0.5% 1/10W	R107	1-216-025-91	RES-CHIP	100 5% 1/10W
R020	1-216-077-91	RES-CHIP	15K 5% 1/10W	R108	1-216-025-91	RES-CHIP	100 5% 1/10W
R022	1-216-089-91	RES-CHIP	47K 5% 1/10W	R201	1-216-025-91	RES-CHIP	100 5% 1/10W
R023	1-216-035-91	RES-CHIP	270 5% 1/10W	R202	1-216-073-91	RES-CHIP	10K 5% 1/10W
R024	1-216-025-91	RES-CHIP	100 5% 1/10W	R211	1-216-081-91	RES-CHIP	22K 5% 1/10W
R025	1-216-025-91	RES-CHIP	100 5% 1/10W	R212	1-216-069-91	RES-CHIP	6.8K 5% 1/10W
R026	1-216-025-91	RES-CHIP	100 5% 1/10W	R213	1-216-081-91	RES-CHIP	22K 5% 1/10W
R027	1-216-025-91	RES-CHIP	100 5% 1/10W	R214	1-216-041-91	RES-CHIP	470 5% 1/10W
R028	1-216-025-91	RES-CHIP	100 5% 1/10W	R215	1-216-037-91	RES-CHIP	330 5% 1/10W
R029	1-216-061-91	RES-CHIP	3.3K 5% 1/10W	R216	1-216-097-91	RES-CHIP	100K 5% 1/10W
R030	1-216-821-91	RES-CHIP	1K 5% 1/16W	R217	1-216-222-91	RES-CHIP	10K 5% 1/8W
R031	1-216-061-91	RES-CHIP	3.3K 5% 1/10W	R220	1-216-031-91	RES-CHIP	180 5% 1/10W
R032	1-216-061-91	RES-CHIP	3.3K 5% 1/10W	R221	1-216-190-91	RES-CHIP	470 5% 1/8W
R033	1-216-073-91	RES-CHIP	10K 5% 1/10W	R232	1-216-025-91	RES-CHIP	100 5% 1/10W
R034	1-216-119-91	RES-CHIP	820K 5% 1/10W	R233	1-216-069-91	RES-CHIP	6.8K 5% 1/10W
R035	1-216-101-91	RES-CHIP	150K 5% 1/10W	R234	1-216-069-91	RES-CHIP	6.8K 5% 1/10W
R036	1-216-073-91	RES-CHIP	10K 5% 1/10W	R235	1-216-295-91	SHORT	0
R039	1-216-065-91	RES-CHIP	4.7K 5% 1/10W	R236	1-216-295-91	SHORT	0
R040	1-216-033-91	RES-CHIP	220 5% 1/10W	R238	1-216-025-91	RES-CHIP	100 5% 1/10W
R041	1-216-025-91	RES-CHIP	100 5% 1/10W	R246	1-260-107-91	CARBON	4.7K 5% 1/2W
R042	1-216-025-91	RES-CHIP	100 5% 1/10W	R248	1-249-429-91	CARBON	10K 5% 1/4W
R044	1-216-073-91	RES-CHIP	10K 5% 1/10W	R249	1-216-097-91	RES-CHIP	100K 5% 1/10W
R045	1-216-025-91	RES-CHIP	100 5% 1/10W	R250	1-216-230-91	RES-CHIP	22K 5% 1/8W
R046	1-216-025-91	RES-CHIP	100 5% 1/10W	R251	1-216-069-91	RES-CHIP	6.8K 5% 1/10W
R047	1-216-025-91	RES-CHIP	100 5% 1/10W	R252	1-216-069-91	RES-CHIP	6.8K 5% 1/10W
R048	1-216-073-91	RES-CHIP	10K 5% 1/10W	R401	1-410-993-42	INDUCTOR	1UH
R049	1-216-049-91	RES-CHIP	1K 5% 1/10W	R402	1-216-041-91	RES-CHIP	470 5% 1/10W
R050	1-216-025-91	RES-CHIP	100 5% 1/10W	R403	1-216-113-91	RES-CHIP	470K 5% 1/10W
R051	1-216-295-91	SHORT	0	R404	1-216-113-91	RES-CHIP	470K 5% 1/10W
R052	1-216-295-91	SHORT	0	R405	1-216-831-91	RES-CHIP	6.8K 5% 1/10W
R053	1-216-077-91	RES-CHIP	15K 5% 1/10W	R406	1-216-296-91	SHORT	0
R055	1-216-025-91	RES-CHIP	100 5% 1/10W	R407	1-216-022-91	RES-CHIP	75 5% 1/10W
R056	1-216-081-91	RES-CHIP	22K 5% 1/10W	R408	1-216-022-91	RES-CHIP	75 5% 1/10W
R060	1-216-025-91	RES-CHIP	100 5% 1/10W	R409	1-216-025-91	RES-CHIP	100 5% 1/10W
R061	1-216-025-91	RES-CHIP	100 5% 1/10W	R410	1-216-025-91	RES-CHIP	100 5% 1/10W
R070	1-216-025-91	RES-CHIP	100 5% 1/10W	R411	1-216-022-91	RES-CHIP	75 5% 1/10W
R071	1-216-049-91	RES-CHIP	1K 5% 1/10W	R412	1-216-025-91	RES-CHIP	100 5% 1/10W

REF.NO.	PART.NO	DESCRIPTION	REMARK	REF.NO.	PART.NO	DESCRIPTION	REMARK
R413	1-216-113-91	RES-CHIP	470K 5% 1/10W	R509	1-208-796-91	METAL CHIP	3.9K 0.5% 1/10W
R414	1-216-022-91	RES-CHIP	75 5% 1/10W	R510	1-216-113-91	RES-CHIP	470K 5% 1/10W
R415	1-216-022-91	RES-CHIP	75 5% 1/10W	R512	1-249-382-91	CARBON	1.2 5% 1/4W
R416	1-216-027-91	RES-CHIP	120 5% 1/10W	R513	1-216-097-91	RES-CHIP	100K 5% 1/10W
R417	1-216-113-91	RES-CHIP	470K 5% 1/10W	R514	1-249-377-91	CARBON	0.47 5% 1/4W
R418	1-216-113-91	RES-CHIP	470K 5% 1/10W	R515	1-249-377-91	CARBON	0.47 5% 1/4W
R419	1-216-022-91	RES-CHIP	75 5% 1/10W	R516	1-214-907-81	METAL	56K 1% 1/2W
R420	1-216-073-91	RES-CHIP	10K 5% 1/10W	R518	1-216-059-91	RES-CHIP	2.7K 5% 1/10W
R421	1-216-049-91	RES-CHIP	1K 5% 1/10W	R520	1-215-884-91	METAL OXIDE	47 5% 2W
R422	1-216-831-91	RES-CHIP	6.8K 5% 1/10W	R522	1-216-097-91	RES-CHIP	100K 5% 1/10W
R423	1-216-113-91	RES-CHIP	470K 5% 1/10W	R523	1-216-117-91	RES-CHIP	680K 5% 1/10W
R424	1-216-113-91	RES-CHIP	470K 5% 1/10W	R524	1-216-079-91	RES-CHIP	18K 5% 1/10W
R425	1-216-085-91	RES-CHIP	33K 5% 1/10W	R526	1-216-089-91	RES-CHIP	47K 5% 1/10W
R426	1-216-073-91	RES-CHIP	10K 5% 1/10W	R527	1-216-075-91	RES-CHIP	12K 5% 1/10W
R427	1-216-113-91	RES-CHIP	470K 5% 1/10W	R528	1-216-097-91	RES-CHIP	100K 5% 1/10W
R428	1-216-073-91	RES-CHIP	10K 5% 1/10W	R529	1-216-073-91	RES-CHIP	10K 5% 1/10W
R429	1-216-089-91	RES-CHIP	47K 5% 1/10W	R530	1-216-085-91	RES-CHIP	33K 5% 1/10W
R430	1-216-073-91	RES-CHIP	10K 5% 1/10W	R531	1-216-057-91	RES-CHIP	2.2K 5% 1/10W
R431	1-216-073-91	RES-CHIP	10K 5% 1/10W	R533	1-216-081-00	RES-CHIP	22K 5% 1/10W
R433	1-216-073-91	RES-CHIP	10K 5% 1/10W	R539	1-215-892-81	METAL OXIDE	1K 5% 2W
R434	1-216-073-91	RES-CHIP	10K 5% 1/10W	R540	1-212-970-61	FUSIBLE	33 5% 1/2W
R435	1-216-295-91	SHORT	0	R542	1-216-121-91	RES-CHIP	1M 5% 1/10W
R438	1-216-022-91	RES-CHIP	75 5% 1/10W	R543	1-216-065-91	RES-CHIP	4.7K 5% 1/10W
R439	1-216-022-91	RES-CHIP	75 5% 1/10W	R544	1-216-103-91	RES-CHIP	180K 5% 1/10W
R440	1-216-049-91	RES-CHIP	1K 5% 1/10W	R547	1-535-143-71	LEAD, JUMPER (7.5MM)	
R441	1-216-051-91	RES-CHIP	1.2K 5% 1/10W	R549	1-535-143-71	LEAD, JUMPER (7.5MM)	
R442	1-216-085-91	RES-CHIP	33K 5% 1/10W	R551	1-215-867-21	METAL OXIDE	470 5% 1W
R443	1-216-073-91	RES-CHIP	10K 5% 1/10W	R552	1-216-089-91	RES-CHIP	47K 5% 1/10W
R444	1-216-061-91	RES-CHIP	3.3K 5% 1/10W	R553	1-249-381-91	CARBON	1 5% 1/4W
R446	1-216-113-91	RES-CHIP	470K 5% 1/10W	R555	1-216-089-91	RES-CHIP	47K 5% 1/10W
R447	1-216-295-91	SHORT	0	R556	1-215-915-51	METAL OXIDE	470 5% 3W
R448	1-216-113-91	RES-CHIP	470K 5% 1/10W	R557	1-216-065-91	RES-CHIP	4.7K 5% 1/10W
R449	1-216-295-91	SHORT	0	R559	1-535-143-61	LEAD, JUMPER (5.0MM)	
R450	1-216-041-91	RES-CHIP	470 5% 1/10W	R561	1-216-117-91	RES-CHIP	680K 5% 1/10W
R451	1-216-041-91	RES-CHIP	470 5% 1/10W	R565	1-216-033-91	RES-CHIP	220 5% 1/10W
R453	1-216-171-91	RES-CHIP	75 5% 1/8W	R568	1-215-915-51	METAL OXIDE	470 5% 3W
R454	1-216-001-91	RES-CHIP	10 5% 1/10W	R569	1-216-073-91	RES-CHIP	10K 5% 1/10W
R455	1-216-295-91	SHORT	0	R570	1-216-049-91	RES-CHIP	1K 5% 1/10W
R460	1-216-049-91	RES-CHIP	1K 5% 1/10W	R571	1-216-035-91	RES-CHIP	270 5% 1/10W
R461	1-216-022-91	RES-CHIP	75 5% 1/10W	R572	1-216-039-91	RES-CHIP	390 5% 1/10W
R462	1-216-029-91	RES-CHIP	150 5% 1/10W	R583	1-216-081-91	RES-CHIP	22K 5% 1/10W
R500	1-216-061-91	RES-CHIP	3.3K 5% 1/10W	R589	1-216-295-91	SHORT	0
R501	1-216-091-91	RES-CHIP	56K 5% 1/10W	R591	1-215-892-51	METAL OXIDE	1K 5% 2W
R502	1-216-073-91	RES-CHIP	10K 5% 1/10W	R601	1-216-645-91	METAL CHIP	560 0.5% 1/10W
R503	1-215-888-21	METAL OXIDE	220 5% 2W	R602	1-202-961-11	CEMENTED	1.8 5% 10W
R504	1-249-385-91	CARBON	2.2 5% 1/4W	R603	1-202-933-11	FUSIBLE	0.1 10% 1/2W
R505	1-216-667-91	METAL CHIP	4.7K 0.5% 1/10W	R605	1-216-049-91	RES-CHIP	1K 5% 1/10W
R506	1-208-796-91	METAL CHIP	3.9K 0.5% 1/10W	R608	1-216-073-91	RES-CHIP	10K 5% 1/10W
R507	1-216-349-51	METAL OXIDE	1 5% 1W	R609	1-216-677-91	METAL CHIP	12K 0.5% 1/10W
R508	1-216-667-91	METAL CHIP	4.7K 0.5% 1/10W	R610	1-215-481-91	METAL	330K 1% 1/4W

A

Note : The components identified by shading and marked Δ are critical for safety. Replace only with the part numbers specified in the parts list.

REF.NO.	PART.NO	DESCRIPTION	REMARK
R611	1-216-059-91	RES-CHIP	2.7K 5% 1/10W
R612	1-249-429-91	CARBON	10K 5% 1/4W
R613	Δ 1-219-720-91	METAL	10M 5% 1W
R615	1-215-385-91	METAL	33 1% 1/4W
R618	1-247-889-91	CARBON	270K 5% 1/4W
R619	1-216-065-91	RES-CHIP	4.7K 5% 1/10W
R621	1-216-113-91	RES-CHIP	470K 5% 1/10W
R622	1-216-073-91	RES-CHIP	10K 5% 1/10W
R623	1-216-065-91	RES-CHIP	4.7K 5% 1/10W
R624	1-216-001-91	RES-CHIP	10 5% 1/10W
R625	1-216-073-91	RES-CHIP	10K 5% 1/10W
R627	1-249-389-91	CARBON	4.7 5% 1/4W
R628	1-247-791-91	CARBON	22 5% 1/4W
R629	1-216-073-91	RES-CHIP	10K 5% 1/10W
R632	1-249-417-91	CARBON	1K 5% 1/4W
R633	1-215-481-91	METAL	330K 1% 1/4W
R634	1-217-625-11	METAL	0.05 10% 2W
R635	1-260-300-71	CARBON	4.7 5% 1/2W
R636	1-249-413-91	CARBON	470 5% 1/4W
R637	1-216-041-91	RES-CHIP	470 5% 1/10W
R639	1-208-814-91	METAL CHIP	22K 0.5% 1/10W
R640	1-208-830-91	METAL CHIP	100K 0.5% 1/10W
R641	1-216-097-91	RES-CHIP	100K 5% 1/10W
R642	1-249-405-91	CARBON	100 5% 1/4W
R643	1-216-089-91	RES-CHIP	47K 5% 1/10W
R645	1-216-073-91	RES-CHIP	10K 5% 1/10W
R647	1-216-049-91	RES-CHIP	1K 5% 1/10W
R648	1-215-481-91	METAL	330K 1% 1/4W
R649	1-208-805-91	METAL CHIP	9.1K 0.5% 1/10W
R650	1-208-758-91	METAL CHIP	100 0.5% 1/10W
R651	1-220-926-21	FUSIBLE	0.47 10% 1/2W
R652	1-216-081-91	RES-CHIP	22K 5% 1/10W
R653	1-216-073-91	RES-CHIP	10K 5% 1/10W
R654	1-216-001-91	RES-CHIP	10 5% 1/10W
R656	1-216-365-51	METAL OXIDE	0.47 5% 2W
R658	1-202-961-11	CEMENTED	1.8 5% 10W
R660	1-247-807-91	CARBON	100 5% 1/4W
R1202	1-216-073-91	RES-CHIP	10K 5% 1/10W
R1207	1-216-077-91	RES-CHIP	15K 5% 1/10W
R1208	1-216-067-91	RES-CHIP	5.6K 5% 1/10W
R1209	1-216-073-91	RES-CHIP	10K 5% 1/10W
R1210	1-216-077-91	RES-CHIP	15K 5% 1/10W
R1211	1-216-049-91	RES-CHIP	1K 5% 1/10W
R1212	1-216-057-91	RES-CHIP	2.2K 5% 1/10W
R1213	1-216-049-91	RES-CHIP	1K 5% 1/10W
R1214	1-216-049-91	RES-CHIP	1K 5% 1/10W
R1215	1-216-049-91	RES-CHIP	1K 5% 1/10W
R1230	1-216-041-91	RES-CHIP	470 5% 1/10W
R1231	1-216-113-91	RES-CHIP	470K 5% 1/10W
R1232	1-216-041-91	RES-CHIP	470 5% 1/10W

REF.NO.	PART.NO	DESCRIPTION	REMARK
R1233	1-216-113-91	RES-CHIP	470K 5% 1/10W
R1235	1-216-073-91	RES-CHIP	10K 5% 1/10W
R1236	1-216-073-91	RES-CHIP	10K 5% 1/10W

< RELAY >

RY601 Δ 1-755-388-11 RELAY (AC POWER)

< SWITCH >

SW532 1-572-707-21 SWITCH, LEVER

< TRANSFORMER >

T511 Δ 1-453-308-31 TRANSFORMER ASSY, FLYBACK (NX-4521//Z2B4)

T531 1-437-210-21 TRANSFORMER, HORIZONTAL DRIVE

T532 1-426-981-91 TRANSFORMER, FERRITE (PMT)

T601 Δ 1-427-962-11 TRANSFORMER, LINE FILTERT602 Δ 1-431-732-31 TRANSFORMER, CONVERTER (SRT)T603 Δ 1-435-977-11 TRANSFORMER, CONVERTER (PIT)

< THERMISTOR >

TH601 1-803-586-41 THERMISTOR

THP601 Δ 1-803-951-11 THERMISTOR, PTC

< CRYSTAL >

X001 1-578-774-71 VIBRATOR, CRYSTAL

X201 1-760-628-21 VIBRATOR, CRYSTAL

A Board Variant Parts KV-25FX30

< CAPACITOR >

C532 1-163-017-91 CERAMIC 0.0047UF 10.00% 50V

C536 1-117-813-21 FILM 0.75UF 5.00% 250V

C537 1-137-417-91 MYLAR 0.0047UF 10.00% 200V

C546 1-130-895-51 FILM 0.056UF 5.00% 400V

C547 1-117-813-11 FILM 0.75UF 5.00% 250V

< DIODE >

D505 8-719-988-61 DIODE 1SS355TE-17

< RESISTOR >

R517 1-215-454-91 METAL 24K 1% 1/4W

R521 1-216-113-91 RES-CHIP 470K 5% 1/10W

R525 1-216-057-91 RES-CHIP 2.2K 5% 1/10W

R532 1-216-073-91 RES-CHIP 10K 5% 1/10W

R534 1-216-109-91 RES-CHIP 330K 5% 1/10W

R535 1-216-109-91 RES-CHIP 330K 5% 1/10W

R546 1-215-915-51 METAL 470 5% 3W

R548 1-212-849-61 FUSIBLE 4.7 5% 1/4W

R562 1-216-097-91 RES-CHIP 100K 5% 1/10W

Note : The components identified by shading and marked Δ are critical for safety. Replace only with the part numbers specified in the parts list.

A

C

REF.NO.	PART.NO	DESCRIPTION	REMARK
R595	1-249-382-91	CARBON 1.2 5%	1/4W
R600	1-216-035-91	RES-CHIP 270 5%	1/10W
< TRANSFORMER >			
T533	1-435-347-11	TRANSFORMER, HORIZONTAL LINEAR	
< TUNER >			
TU101	8-598-535-10	FRONTEND BTF-EF411 (KV-25FX30B)	
	8-598-533-00	FRONTEND BTF-EC411 (KV-25FX30E/25FX30K)	
A Board Variant Parts KV-29FX30			
< CAPACITOR >			
C530	1-162-970-91	CERAMIC 0.01UF	10.00% 50V
C532	1-163-037-91	CERAMIC 0.022UF	10.00% 50V
C536	1-115-521-21	FILM 0.82UF	5.00% 250V
C537	1-106-351-91	MYLAR 0.0022UF	99.00% 200V
C546	1-130-118-51	FILM 0.051UF	5.00% 400V
C547	1-115-521-11	FILM 0.82UF	5.00% 250V
C1232	1-115-339-11	CERAMIC 0.1UF	10.00% 50V
< DIODE >			
D505	8-719-081-97	DIODE MMDL914T1	
< RESISTOR >			
R517	1-215-447-91	METAL 12K 1%	1/4W
R521	1-216-103-91	RES-CHIP 180K 5%	1/10W
R525	1-216-041-91	RES-CHIP 470 5%	1/10W
R532	1-216-059-91	RES-CHIP 2.7K 5%	1/10W
R534	1-216-111-91	RES-CHIP 390K 5%	1/10W
R535	1-216-093-91	RES-CHIP 68K 5%	1/10W
R541	1-216-109-91	RES-CHIP 330K 5%	1/10W
R546	1-216-479-51	METAL OXIDE 560 5%	3W
R548	1-249-387-91	CARBON 3.3 5%	1/4W
R562	1-216-099-91	RES-CHIP 120K 5%	1/10W
R563	1-216-097-91	RES-CHIP 100K 5%	1/10W
R595	1-249-377-91	CARBON 0.47 5%	1/4W
R600	1-216-037-91	RES-CHIP 330 5%	1/10W
< TRANSFORMER >			
T533	1-433-906-11	TRANSFORMER, HORIZONTAL LINEAR	
< TUNER >			
TU101	8-598-535-10	FRONTEND BTF-EF411 (KV-29FX30B)	
	8-598-533-00	FRONTEND BTF-EC411 (KV-29FX30E/29FX30K)	

REF.NO.	PART.NO	DESCRIPTION	REMARK
*A-1639-021-A C Board, Complete			
	4-382-854-01	SCREW (M3X8), P, SW (+)	
	4-382-854-01	SCREW (M3X8), P, SW (+)	
< CAPACITOR >			
C701	1-136-189-91	MYLAR 0.1UF	10.00% 250V
C702	1-126-964-91	ELECT 10UF	20.00% 50V
C703	1-101-004-91	CERAMIC 0.01UF	50V
C704	1-107-649-91	ELECT 2.2UF	20.00% 250V
C708	1-162-114-51	CERAMIC 0.0047UF	2KV
C710	1-107-652-91	ELECT 10UF	20.00% 250V
C1803	1-101-005-91	CERAMIC 0.022UF	50V
C1804	1-126-964-91	ELECT 10UF	20.00% 50V
C1805	1-101-880-91	CERAMIC 47PF	5.00% 50V
< CONNECTOR >			
CN702	1-695-915-21	TAB (CONTACT)	
CN703	*1-564-510-51	PLUG, CONNECTOR 7P	
CN706	1-695-915-21	TAB (CONTACT)	
CN707	*1-564-508-51	PLUG, CONNECTOR 5P	
CN1801	*1-564-506-51	PLUG, CONNECTOR 3P	
< DIODE >			
D701	8-719-991-33	DIODE 1SS133T-77	
D702	8-719-901-83	DIODE 1SS83	
D703	8-719-901-83	DIODE 1SS83	
D705	8-719-302-43	DIODE EL1Z	
D706	8-719-901-83	DIODE 1SS83	
D707	8-719-901-83	DIODE 1SS83	
D708	8-719-109-97	DIODE RD6.8ES-B2	
D709	8-719-109-97	DIODE RD6.8ES-B2	
D710	8-719-109-97	DIODE RD6.8ES-B2	
D1801	8-719-110-17	DIODE RD10ESB2	
D1802	8-719-110-17	DIODE RD10ESB2	
D1803	8-719-110-17	DIODE RD10ESB2	
< IC >			
IC701	8-759-562-43	IC TDA6108JF/N1B	
IC1801	8-759-603-37	IC M5216P	
< SOCKET >			
J701	Δ 1-251-732-11	SOCKET, CRT	
< COIL >			
L704	1-414-183-31	INDUCTOR 10UH	
< RESISTOR >			
R701	1-247-903-91	CARBON 1M 5%	1/4W

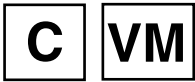

REF.NO.	PART.NO	DESCRIPTION	REMARK
R702	1-249-429-91	CARBON 10K 5%	1/4W
R703	1-247-903-91	CARBON 1M 5%	1/4W
R704	1-535-143-31	LEAD, JUMPER (15.0MM)	
R705	1-215-869-21	METAL OXIDE 1K 5%	1W
R706	1-249-411-91	CARBON 330 5%	1/4W
R712	1-215-869-21	METAL OXIDE 1K 5%	1W
R716	1-249-411-91	CARBON 330 5%	1/4W
R718	1-202-814-91	SOLID 33K 10%	1/2W
R726	1-215-869-21	METAL OXIDE 1K 5%	1W
R727	1-249-411-91	CARBON 330 5%	1/4W
R728	1-249-398-91	CARBON 27 5%	1/4W
R741	1-202-549-81	SOLID 100 20%	1/2W
R1801	1-249-441-91	CARBON 100K 5%	1/4W
R1805	1-249-429-91	CARBON 10K 5%	1/4W
R1806	1-247-899-91	CARBON 680K 5%	1/4W
R1807	1-249-429-91	CARBON 10K 5%	1/4W
R1808	1-249-429-91	CARBON 10K 5%	1/4W
R1809	1-249-429-91	CARBON 10K 5%	1/4W
R1810	1-249-429-91	CARBON 10K 5%	1/4W

< VARIABLE RESISTOR >

RV702 1-241-656-11 RES, ADJ, METAL FILM 110M

***A-1645-046-A VM Board, Complete (KV-25FX30)**
***A-1645-048-A VM Board, Complete (KV-29FX30)**

VM Board, Common Parts

< CAPACITOR >

C1701	1-104-665-91	ELECT 100UF	20.00% 25V
C1702	1-162-970-91	CERAMIC CHIP 0.01UF	10.00% 25V
C1703	1-162-955-91	CERAMIC CHIP 150PF	5.00% 50V
C1704	1-104-665-91	ELECT 100UF	20.00% 25V
C1705	1-162-919-91	CERAMIC CHIP 22PF	5.00% 50V
C1710	1-106-375-81	MYLAR 0.022UF	10.00% 250V
C1711	1-106-375-81	MYLAR 0.022UF	10.00% 250V
C1721	1-107-639-91	ELECT 47UF	20.00% 160V
C1722	1-136-153-81	FILM 0.01UF	5.00% 50V
C1723	1-126-935-91	ELECT 470UF	20.00% 10V
C1728	1-126-935-91	ELECT 470UF	20.00% 10V
C1733	1-104-664-91	ELECT 47UF	20.00% 25V
C1734	1-104-664-91	ELECT 47UF	20.00% 25V
C1737	1-104-999-51	MYLAR 0.1UF	5.00% 200V
C1844	1-129-716-91	FILM 0.015UF	5.00% 630V
C1845	1-129-725-91	FILM 0.082UF	5.00% 400V
C1848	1-136-347-91	FILM 0.0047UF	5.00% 630V
C1901	1-162-927-91	CERAMIC CHIP 100PF	5.00% 50V
C1902	1-137-374-91	MYLAR 0.047UF	5.00% 50V
C1903	1-126-964-91	ELECT 10UF	20.00% 50V
C1904	1-137-366-91	MYLAR 0.0022UF	5.00% 50V

REF.NO.	PART.NO	DESCRIPTION	REMARK
C1905	1-137-374-91	MYLAR 0.047UF	5.00% 50V
C1906	1-162-970-91	CERAMIC CHIP 0.01UF	10.00% 25V
C1908	1-109-954-91	ELECT 0.47UF	20.00% 160V
C1911	1-109-954-91	ELECT 0.47UF	20.00% 160V
C1913	1-129-992-91	FILM 0.0024UF	5.00% 630V
C1914	1-102-244-91	CERAMIC 220PF	10.00% 500V
C1915	1-136-205-91	MYLAR 0.022UF	10.00% 250V
C1916	1-162-962-91	CERAMIC CHIP 470PF	10.00% 50V
C1951	1-126-964-91	ELECT 10UF	20.00% 50V
C1952	1-126-964-91	ELECT 10UF	20.00% 50V
C1953	1-137-367-91	MYLAR 0.0033UF	5.00% 50V
C1954	1-162-970-91	CERAMIC CHIP 0.01UF	10.00% 25V
C1957	1-126-964-91	ELECT 10UF	20.00% 50V
C1958	1-136-169-91	FILM 0.22UF	5.00% 50V
C1959	1-136-169-91	FILM 0.22UF	5.00% 50V

< CONNECTOR >

CN1701	1-691-771-11	PLUG (MICRO CONNECTOR) 9P	
CN1702	*1-564-506-51	PLUG, CONNECTOR 3P	
CN1718	*1-770-723-11	CONNECTOR, BOARD TO BOARD 8P	

< DIODE >

D1711	8-719-988-61	DIODE 1SS355TE-17	
D1719	8-719-991-33	DIODE 1SS133T-77	
D1722	8-719-991-33	DIODE 1SS133T-77	
D1733	8-719-921-40	DIODE MTZJ-T-4.7C	
D1734	8-719-921-40	DIODE MTZJ-T-4.7C	
D1840	8-719-302-43	DIODE EL1Z	
D1901	8-719-991-33	DIODE 1SS133T-77	
D1902	8-719-991-33	DIODE 1SS133T-77	
D1903	8-719-991-33	DIODE 1SS133T-77	
D1904	8-719-991-33	DIODE 1SS133T-77	
D1905	8-719-110-41	DIODE RD15ES-B2	
D1906	8-719-970-87	DIODE ERA38-06	
D1907	8-719-970-87	DIODE ERA38-06	
D1908	8-719-300-33	DIODE RU-3AM	
D1909	8-719-991-33	DIODE 1SS133T-77	

< FERRITE BEAD >

FB1701	1-535-143-61	LEAD, JUMPER (5.0MM)	
--------	--------------	----------------------	--

< IC >

IC1701	8-759-394-36	IC BA09T	
IC1901	8-759-450-95	IC LM393N	
IC1902	8-759-008-70	IC LM358N	

< COIL >

L1701	1-414-183-31	INDUCTOR 10UH	
L1702	1-412-525-41	INDUCTOR 10UH	
L1703	1-414-184-31	INDUCTOR 15UH	



REF.NO.	PART.NO	DESCRIPTION	REMARK
R1966	1-215-887-51	METAL OXIDE 150 5%	2W
R1967	1-215-917-51	METAL OXIDE 1K 5%	3W
R1968	1-215-887-51	METAL OXIDE 150 5%	2W
R1969	1-215-917-51	METAL OXIDE 1K 5%	3W

VM Board Variant Parts KV-29FX30

< CAPACITOR >

C1917	1-102-228-91	CERAMIC	470PF 10.00%	500V
-------	--------------	---------	--------------	------

< RESISTOR >

R1847	1-216-476-21	METAL OXIDE	180 5%	3W
R1848	1-215-911-21	METAL OXIDE	100 5%	3W
R1918	1-215-922-91	METAL OXIDE	6.8K 5%	3W
R1921	1-215-922-91	METAL OXIDE	6.8K 5%	3W
R1931	1-216-691-91	RES-CHIP	47K 5%	1/10W
R1966	1-215-886-91	METAL OXIDE	100 5%	2W
R1967	1-215-922-51	METAL OXIDE	6.8K 5%	3W
R1968	1-215-886-91	METAL OXIDE	100 5%	2W
R1969	1-216-485-21	METAL OXIDE	5.6K 5%	3W

***A-1646-240-A H1 Board, Complete**

4-203-258-02 HOLDER, LED

< CAPACITOR >

C900	1-102-074-91	CERAMIC	0.001UF 10.00%	50V
C901	1-102-074-91	CERAMIC	0.001UF 10.00%	50V
C902	1-137-372-91	MYLAR	0.022UF 5.00%	50V
C903	1-137-372-91	MYLAR	0.022UF 5.00%	50V
C904	1-104-665-91	ELECT	100UF 20.00%	25V
C905	1-126-964-91	ELECT	10UF 20.00%	50V
C906	1-126-960-91	ELECT	1UF 20.00%	50V
C907	1-126-960-91	ELECT	1UF 20.00%	50V
C908	1-137-366-91	MYLAR	0.0022UF 5.00%	50V
C909	1-137-366-91	MYLAR	0.0022UF 5.00%	50V
C911	1-102-074-91	CERAMIC	0.001UF 10.00%	50V
C912	1-102-074-91	CERAMIC	0.001UF 10.00%	50V

< CONNECTOR >

CN906	*1-564-511-51	PLUG, CONNECTOR 8P
CN907	*1-564-510-51	PLUG, CONNECTOR 7P
CN908	*1-564-509-51	PLUG, CONNECTOR 6P

< DIODE >

D901	8-719-302-45	DIODE SEL1210S-D
D902	8-719-929-15	DIODE HZS9.1NB2
D903	8-719-929-15	DIODE HZS9.1NB2
D904	8-719-109-97	DIODE RD6.8ES-B2
D905	8-719-109-97	DIODE RD6.8ES-B2

REF.NO.	PART.NO	DESCRIPTION	REMARK
D906	8-719-923-60	DIODE MTZJ-T-77-9.1A	
D907	8-719-923-60	DIODE MTZJ-T-77-9.1A	
D908	8-719-923-60	DIODE MTZJ-T-77-9.1A	

< IC >

IC900	8-742-180-30	HYB IC SBX3081-51(20)
-------	--------------	-----------------------

< JACK >

J900	1-750-264-11	JACK
J901	1-779-947-12	TERMINAL BLOCK, S

< COIL >

L900	1-414-740-21	INDUCTOR	4.7UH
L901	1-414-740-21	INDUCTOR	4.7UH
L902	1-414-934-21	INDUCTOR	10UH
L903	1-414-934-21	INDUCTOR	10UH
L904	1-410-119-21	INDUCTOR	1MH

< RESISTOR >

R900	1-247-807-91	CARBON	100 5%	1/4W
R901	1-249-427-91	CARBON	6.8K 5%	1/4W
R902	1-535-143-61	LEAD, JUMPER (5.0MM)		
R903	1-249-406-91	CARBON	120 5%	1/4W
R904	1-249-406-91	CARBON	120 5%	1/4W
R908	1-249-401-91	CARBON	47 5%	1/4W
R909	1-247-895-91	CARBON	470K 5%	1/4W
R910	1-247-895-91	CARBON	470K 5%	1/4W
R911	1-249-431-91	CARBON	15K 5%	1/4W
R912	1-249-429-91	CARBON	10K 5%	1/4W
R913	1-247-843-91	CARBON	3.3K 5%	1/4W
R914	1-249-419-91	CARBON	1.5K 5%	1/4W
R915	1-249-406-91	CARBON	120 5%	1/4W
R916	1-249-406-91	CARBON	120 5%	1/4W
R917	1-247-807-91	CARBON	100 5%	1/4W
R918	1-247-807-91	CARBON	100 5%	1/4W

< SWITCH >

S900	1-692-979-11	SWITCH, TACTILE
S901	1-692-979-11	SWITCH, TACTILE
S902	1-692-979-11	SWITCH, TACTILE

Note : The components identified by shading and marked Δ are critical for safety. Replace only with the part numbers specified in the parts list.

REF.NO.	PART.NO	DESCRIPTION	REMARK	REF.NO.	PART.NO	DESCRIPTION	REMARK
---------	---------	-------------	--------	---------	---------	-------------	--------

MISCELLANEOUS

Δ	1-571-433-31	SWITCH, PUSH (AC POWER)	
Δ	1-783-083-11	CORD, POWER (WITH FILTER)	
	1-424-733-11	COIL, PFC CHOKE 65MMH	
Δ	1-453-308-31	TRANSFORMER ASSY, FLYBACK (NX4521//Z2B4)	
	8-598-535-10	FRONTEND BTF-EF411 (KV-25FX30B/29FX30B)	
	8-598-533-00	FRONTEND BTF-EC411 (KV-25FX30E/25FX30K KV-29FX30E/29FX30K)	
	1-529-988-11	SPEAKER (4.2X24CM)	
Δ	8-753-250-05	PICTURE TUBE (A60LPN70X) (KV-25FX30)	
Δ	8-753-053-05	PICTURE TUBE (M68LNH060X) (KV-29FX30)	
	1-451-475-11	DEFLECTION YOKE (Y25RSA) (KV-25FX30)	
	8-451-494-51	DEFLECTION YOKE (Y29RSA-L) (KV-29FX30)	
	1-452-896-11	COIL, NA ROTATION (RT-200)	
Δ	1-419-142-11	COIL DEGAUSSING (KV-25FX30)	
Δ	1-416-654-11	COIL DEMAGNETIC (KV-29FX30)	
	8-453-011-11	NECK ASSY, NA299M	
Δ	1-251-537-22	CAP ASSY, HIGH VOLTAGE	
	1-452-094-11	MAGNET, ROTATABLE DISK; 15MM	
	1-452-032-11	MAGNET, DISK; 10MM	

ACCESSORIES AND PACKAGING MATERIALS

	*4-029-168-01	BAG, PROTECTION	
	*4-204-807-01	CUSHION (LOWER) (ASSY) (KV-25FX30)	
	*4-204-780-01	CUSHION (LOWER) (ASSY) (KV-29FX30)	
	*4-204-810-01	CUSHION (UPPER) (ASSY) (KV-25FX30)	
	*4-204-783-01	CUSHION (UPPER) (ASSY) (KV-29FX30)	
	*4-204-811-11	INDIVIDUAL CARTON (KV-25FX30)	
	*4-204-784-11	INDIVIDUAL CARTON (KV-29FX30)	
	4-206-062-21	INSTRUCTION MANUAL (KV-25FX30B/29FX30B) (GERMAN/FRENCH/ITALIAN/DUTCH)	
	4-206-060-11	INSTRUCTION MANUAL (KV-25FX30E/29FX30E) (ITALIAN)	
	4-206-060-51	INSTRUCTION MANUAL (KV-25FX30E/29FX30E) (GERMAN/GREEK/TURKISH)	
	4-206-060-61	INSTRUCTION MANUAL (KV-25FX30E/29FX30E) (DANISH/SPANISH/NORWEGIAN/PORTUGUESE/ SWEDISH/FINNISH)	
	4-206-060-31	INSTRUCTION MANUAL (KV-25FX30K/29FX30K) (BULGARIAN/CZECH/ENGLISH/HUNGARIAN/ POLISH/RUSSIAN)	

REMOTE COMMANDER

	1-418-476-21	COMMANDER, STANDARD (RM-887)	
--	--------------	------------------------------	--

TRACE

A new TV Repair Assistance Tool that combines ease of use and powerful PC software tools to allow you to save valuable time during many TV repairs.



The TRACE interface connects to the PC's serial port. It provides connection to the TV's I²C bus and can be provided with an InfraRed transmitter (optional).

The interface is powered by a standard 9 V PP3 battery for portable use, and can also be powered by an external 9V/25mA DC power supply.

The TRACE software that is supplied with the interface allows you to:

- Read, restore and compare NVM contents via the I²C bus
- Acknowledge check of all I²C devices in the TV set
- Read Error Codes (emulation of the Error Reader tool)

With the optional IR Add-on kit, the following features can be added:

- Remote Commander emulation
- User programmable Functional Check through Infrared
- Fast and documented Test Mode setting of all Sony TV chassis

Additional features such as Adjustments and Troubleshooting are available in chassis-dependent software modules. Please contact your local Sony Service organisation for the latest information.

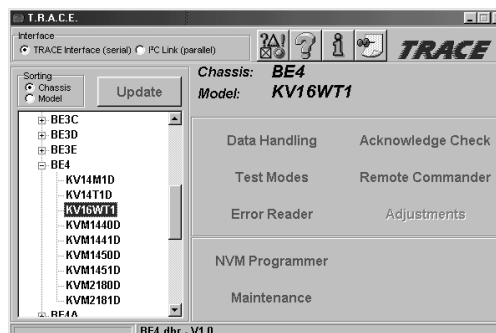

Note: For workshops already using the existing I²C Link parallel port interface (9-948-320-30), this software can be used as well, replacing the TV Data Handling software (9-948-340-50), but Error Reader and IR functions can only be accessed with the TRACE interface.

Partnumbers: TRACE Starter Kit (TRACE interface + software): 9-948-320-70
TRACE Software (for users of the I²C Link interface): 9-948-340-80
TRACE IR Add-on (IR interface + Remote Commander software): 9-948-320-80

PC requirements: IBM-compatible PC with operating system Windows95, Windows98, or WindowsNT*.

* WindowsNT only supported with TRACE interface