



UNISONIC TECHNOLOGIES CO., LTD

UP1855

PNP SILICON TRANSISTOR

HIGH CURRENT TRANSISTOR

■ FEATURES

- * High current switching
- * Low $V_{CE(SAT)}$
- * High h_{FE}

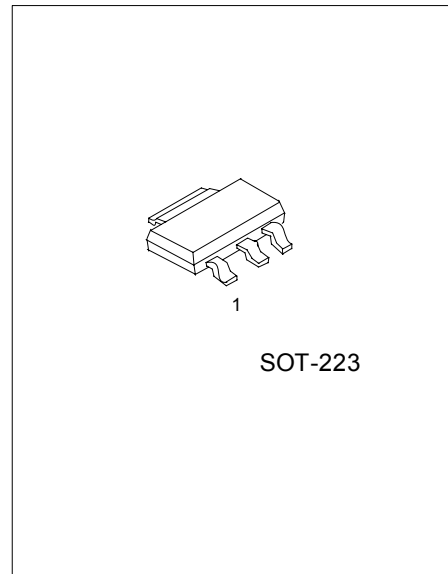

*Pb-free plating product number: UP1855L

■ ORDERING INFORMATION

Order Number		Package	Pin Assignment			Packing
Normal	Lead Free Plating		1	2	3	
UP1855-x-AA3-R	UP1855L-x-AA3-R	SOT-223	B	C	E	Tape Reel

<p>UP1855L-x-AA3-R</p> <p>(1) Packing Type (2) Package Type (3) Rank (4) Lead Plating</p>	<p>(1) R: Tape Reel (2) AA3: SOT-223 (3) refer to Classification of h_{FE2} (4) L: Lead Free Plating, Blank: Pb/Sn</p>
---	---

■ ABSOLUTE MAXIMUM RATINGS (Ta = 25 °C)

PARAMETER	SYMBOL	RATINGS	UNIT
Collector -Base Voltage	V_{CB0}	-180	V
Collector -Emitter Voltage	V_{CEO}	-140	V
Emitter -Base Voltage	V_{EBO}	-6	V
Collector Current (Pulse)	I_{CM}	-10	A
Collector Current (DC)	I_C	-4	A
Power Dissipation	P_D	1	W
Junction Temperature	T_J	+150	
Storage Temperature	T_{STG}	-40 ~ +150	

Note Absolute maximum ratings are those values beyond which the device could be permanently damaged.

Absolute maximum ratings are stress ratings only and functional device operation is not implied.

■ ELECTRICAL CHARACTERISTICS (Ta = 25 °C, unless otherwise specified)

PARAMETER	SYMBOL	TEST CONDITIONS	MIN	TYP	MAX	UNIT
Collector-Base Breakdown Voltage	BV_{CB0}	$I_C = -100\mu A$	-180	-210		V
Collector-Emitter Breakdown Voltage	BV_{CEO}	$I_C = -10mA$	-140	-170		V
Emitter-Base Breakdown Voltage	BV_{EBO}	$I_E = -100\mu A$	-6	-8		V
Collector Cut-off Current	I_{CBO}	$V_{CB} = -150V$ $V_{CB} = -150V, T_a = 100^\circ C$			-50 -1	nA μA
Emitter Cut-off Current	I_{EBO}	$V_{EB} = -6V$			-10	nA
Collector-Emitter Saturation Voltage	$V_{CE(SAT)}$	$I_C = -100mA, I_B = -5mA$ $I_C = -500mA, I_B = -50mA$ $I_C = -1A, I_B = -100mA$ $I_C = -3A, I_B = -300mA$		-30 -70 -110 -275	-60 -120 -150 -370	mV
Base-Emitter Saturation Voltage	$V_{BE(SAT)}$	$I_C = -3A, I_B = -300mA$		-970	-1110	mV
Base-Emitter Turn-On Voltage	$V_{BE(ON)}$	$I_C = -3A, V_{CE} = -5V$		-830	-950	mV
DC Current Gain	h_{FE1}	$I_C = -10mA, V_{CE} = -5V$	100	200		
	h_{FE2}	$I_C = -1A, V_{CE} = -5V$	100		300	
	h_{FE3}	$I_C = -3A, V_{CE} = -5V$	75	140		
	h_{FE4}	$I_C = -10A, V_{CE} = -5V$		10		
Transition Frequency	f_T	$I_C = -100mA, V_{CE} = -10V, f = 50MHz$		110		MHz
Output Capacitance	C_{ob}	$V_{CB} = -20V, f = 1MHz$		40		pF
Switching Times	t_{ON}	$I_C = -1A, V_{CC} = -50V$		68		ns
	t_{OFF}	$I_{B1} = -100mA, I_{B2} = 100mA$		1030		ns

Note: Pulse test: $t_P \leq 300\mu s$, Duty cycle $\leq 2\%$

■ CLASSIFICATION OF h_{FE2}

RANK	A	B
RANGE	100 ~ 200	180 ~ 300

TYPICAL CHARACTERISTICS

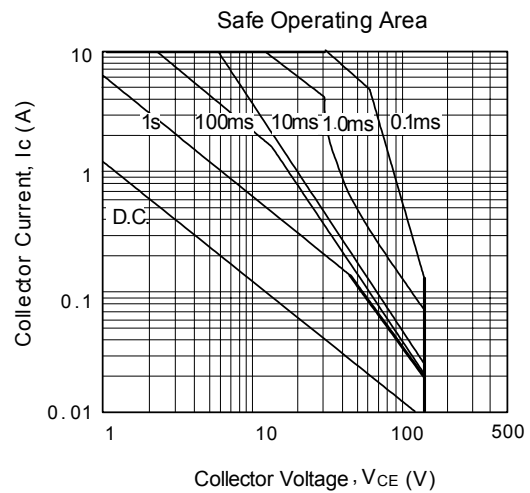
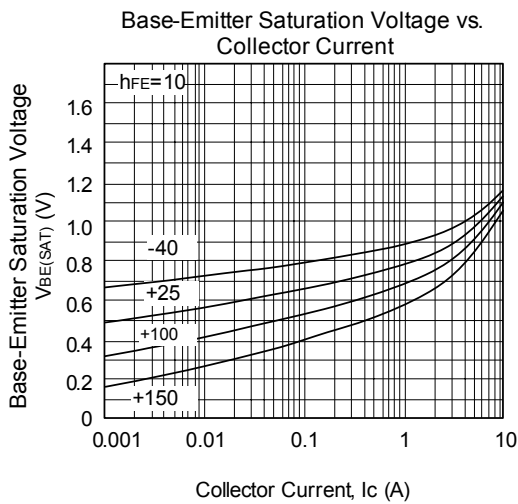
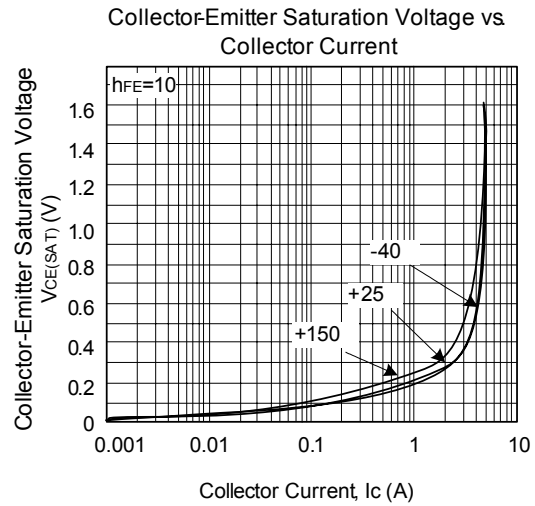
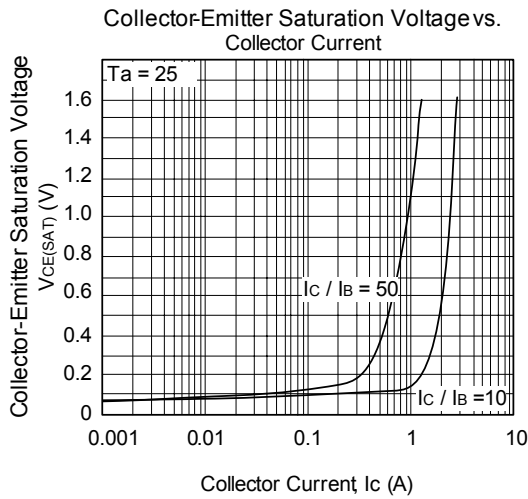
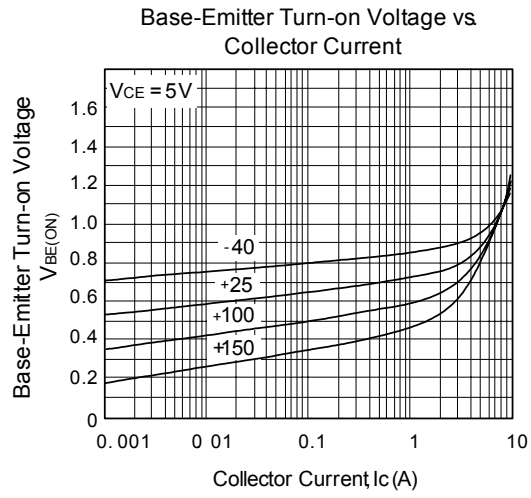
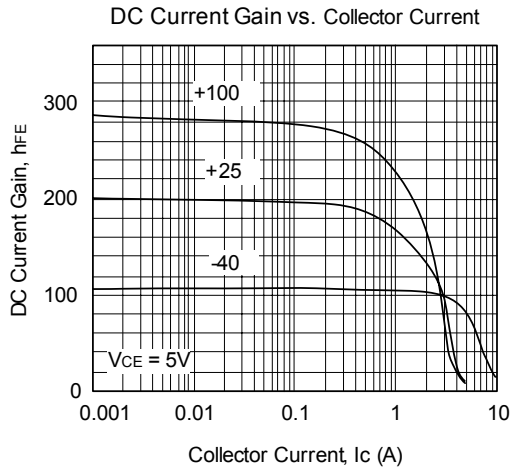

UTC assumes no responsibility for equipment failures that result from using products at values that exceed, even momentarily, rated values (such as maximum ratings, operating condition ranges, or other parameters) listed in products specifications of any and all UTC products described or contained herein. UTC products are not designed for use in life support appliances, devices or systems where malfunction of these products can be reasonably expected to result in personal injury. Reproduction in whole or in part is prohibited without the prior written consent of the copyright owner. The information presented in this document does not form part of any quotation or contract, is believed to be accurate and reliable and may be changed without notice.