



# BRIGHT LED ELECTRONICS CORP.

## LED LAMPS SPECIFICATION

TOTAL PAGE: 5  
 PAGE: 1  
 REVISION: 1.0

- COMMODITY : 1.0"Lead Tower 2.0 φ
- DEVICE NUMBER : BL-S2149A

SHEET DATE	1	2	3	4	5							CONTENTS
2002.10.31	1.0	1.0	1.0	1.0	1.0							Initial Released

TOTAL PAGE	5																
------------	---	--	--	--	--	--	--	--	--	--	--	--	--	--	--	--	--

### 佰鴻工業股份有限公司

**BRIGHT LED ELECTRONICS CORP.**  
 台北縣板橋市和平路 19 號 3 樓  
 3F., No. 19, Ho Ping Road, Pan Chiao City,  
 Taipei, Taiwan, R. O. C.  
 Tel: 886-2-29591090  
 Fax: 886-2-29547006/29558809  
[www.brtled.com](http://www.brtled.com)

APPROVED	DRAWN
<p>郭 2002.11.01 偉斌</p>	<p>余 2002.11.01 愛萍</p>

# BRIGHT LED ELECTRONICS CORP.

## LED LAMPS SPECIFICATION

●COMMODITY : 1.0"Lead Tower 2.0 φ

PAGE: 2

●DEVICE NUMBER : BL-S2149A

VERSION : 1.0

●ELECTRICAL AND OPTICAL CHARACTERISTICS (Ta=25°C)

Chip		Lens Appearance	Absolute Maximum Rating				Electro-optical Data (At 20mA)			Viewing Angle 2θ 1/2 (deg)
Emitted Color	Peak Wave Length λ P(nm)		Δ λ (nm)	Pd (mW)	If (mA)	Peak If(mA)	Vf(V)		Iv Typ. (mcd)	
							Typ.	Max.		
Green	568	Green Diffused	30	80	30	150	2.2	2.6	8.0	120

Remark : Viewing angle is the Off-axis angle at which the luminous intensity is half the axial luminous intensity.

●ABSOLUTE MAXIMUM RATINGS (Ta=25°C)

Reverse Voltage .....	5V
Reverse Current (VR=5V) .....	100μA
Operating Temperature Range .....	-40°C ~ 80°C
Storage Temperature Range .....	-40°C ~ 85°C
Lead Soldering Temperature .....	260°C For 5 Seconds

●PACKAGE DIMENSIONS

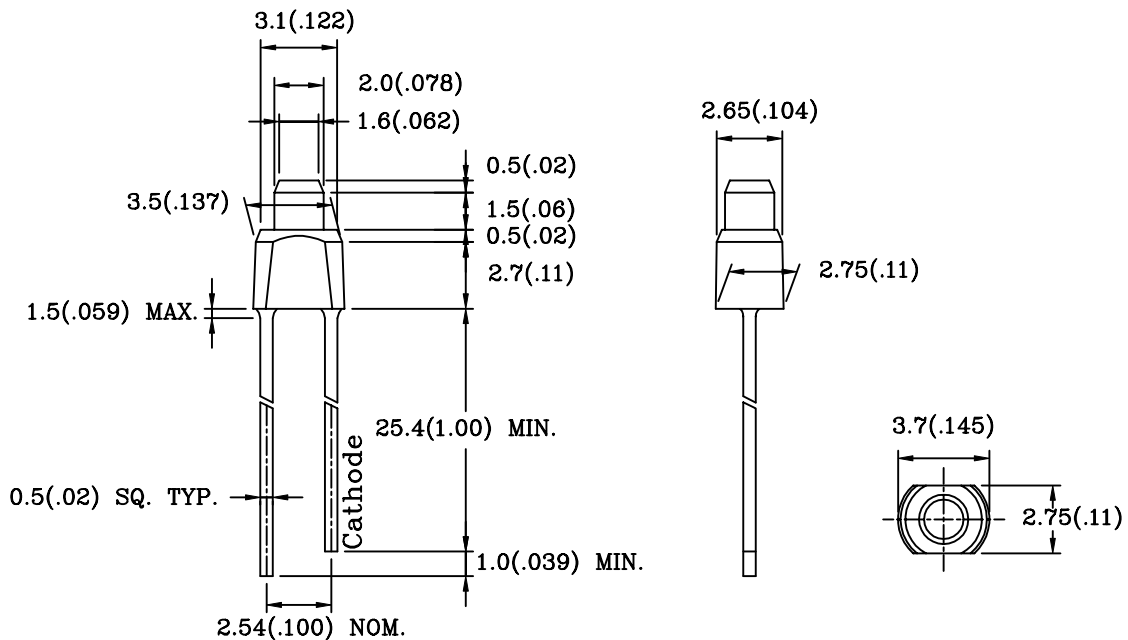

NOTES: 1.All dimensions are in millimeters (inches).

2.Tolerance is ± 0.25mm (0.01") unless otherwise specified.

3.Lead spacing is measured where the leads emerge from the package.

4.Specifications are subject to change without notice.

# BRIGHT LED ELECTRONICS CORP.

## LED LAMPS SPECIFICATION

● COMMODITY: 1.0" Lead Tower 2.0φ

● DEVICE NUMBER: BL-S2149A

PAGE: 3

● ELECTRICAL AND OPTICAL CHARACTERISTICS (Ta=25°C)

REVISION: 1.0

SPECTRAL DISTRIBUTION

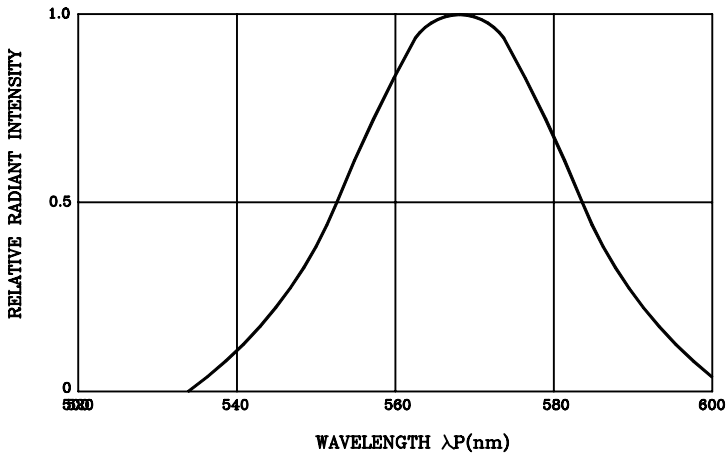

FORWARD CURRENT DERATING CURVE

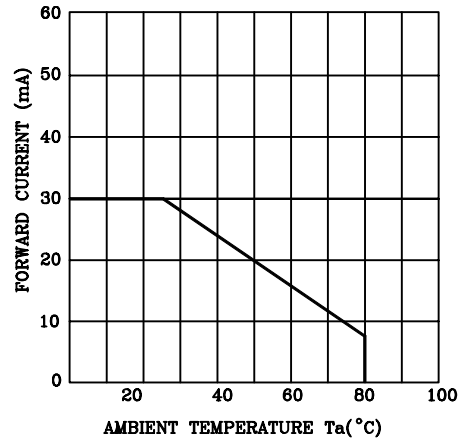

FORWARD CURRENT VS. FORWARD VOLTAGE

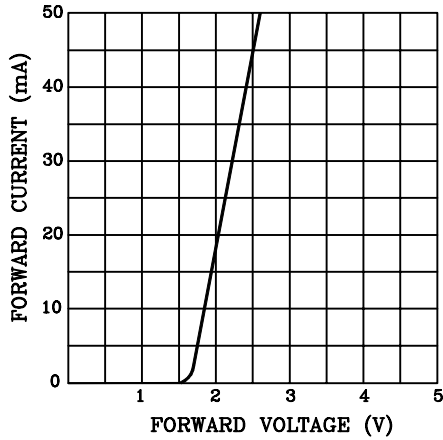

RELATIVE LUMINOUS INTENSITY VS. AMBIENT TEMPERATURE

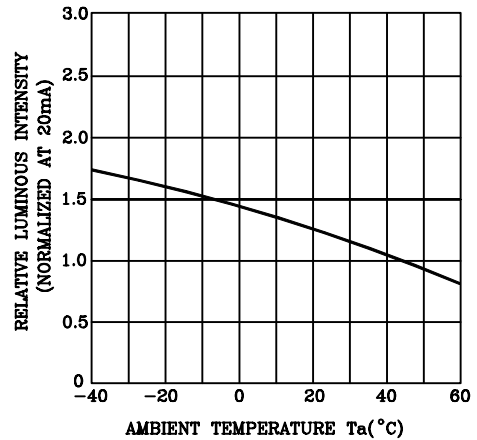

RELATIVE LUMINOUS INTENSITY VS. FORWARD CURRENT

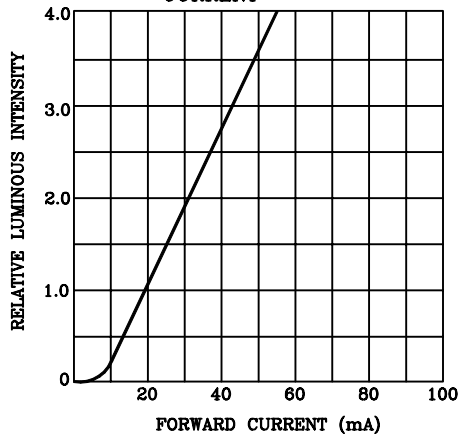

RADIATION DIAGRAM

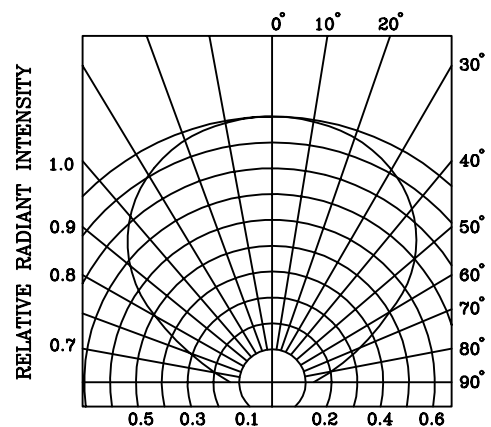

# BRIGHT LED ELECTRONICS CORP.

## LED LAMPS SPECIFICATION

### RELIABILITY TEST

PAGE: 4

REVISION: 1.0

Classification	Test Item	Reference Standard	Test Conditions	Result
Endurance Test	Operation Life	MIL-STD-750:1026 MIL-STD-883:1005 JIS C 7021 :B-1	Connect with a power $I_f=20\text{mA}$ $T_a$ =Under room temperature Test time=1,000hrs	0/100
	High Temperature High Humidity Storage	MIL-STD-202:103B JIS C 7021 :B-11	$T_a=85^\circ\text{C}\pm 5^\circ\text{C}$ RH=90%-95% Test time=240hrs	0/100
	High Temperature Storage	MIL-STD-883:1008 JIS C 7021 :B-10	High $T_a=105^\circ\text{C}\pm 5^\circ\text{C}$ Test time=1,000hrs	0/100
	Low Temperature Storage	JIS-C-7021 :B-12	Low $T_a=-55^\circ\text{C}\pm 5^\circ\text{C}$ Test time=1,000hrs	0/100
Environmental Test	Temperature Cycling	MIL-STD-202:107D MIL-STD-750:1051 MIL-STD-883:1010 JIS C 7021 :A-4	$-55^\circ\text{C} \sim 25^\circ\text{C} \sim 105^\circ\text{C} \sim 25^\circ\text{C}$ 30min 5min 30min 5min Test Time=10cycle	0/100
	Thermal Shock	MIL-STD-202:107D MIL-STD-750:1051 MIL-STD-883:1011	$-55^\circ\text{C}\pm 5^\circ\text{C} \sim 105^\circ\text{C}\pm 5^\circ\text{C}$ 10min 10min Test Time=10cycle	0/100
	Solder Resistance	MIL-STD-202:201A MIL-STD-750:2031 JIS C 7021 :A-1	$T_{\text{sol}}=260\pm 5^\circ\text{C}$ Dwell Time= $5\pm 1\text{sec.}$	0/50
	Solder ability	MIL-STD-202:208D MIL-STD-750:2026 MIL-STD-883:2003 JIS C 7021 :A-2	$T_{\text{sol}}=230\pm 5^\circ\text{C}$ Dwell Time= $5\pm 1\text{sec.}$	0/50
	Lead Bending Stress	MIL-STD-750:2036 JIS C 7021 :A-11	$0^\circ\sim 90^\circ\sim 0^\circ\text{bend}$ , 3 cycles Weight 250g	0/50

#### JUDGMENT CRITERIA OF FAILURE FOR THE RELIABILITY

Measuring items	Symbol	Measuring conditions	Judgement criteria for failure
Forward voltage	$V_F$	$I_f=20\text{mA}$	Over $U_x1.2$
Reverse current	$I_r$	$V_r=5\text{V}$	Over $U_x2$
Luminous intensity	$I_v$	$I_f=20\text{mA}$	Below $S_x0.5$

Note: 1.U means the upper limit of specified characteristics. S means initial value.

2.Measurment shall be taken between 2 hours and after the test pieces have been returned to normal ambient conditions after completion of each test.

# BRIGHT LED ELECTRONICS CORP.

## PACKAGING DIMMENSIONS

PAGE: 5

REVISION: 1.0

### PACKAGING BOX DIMENSIONS



### PACKAGING BAG DIMENSIONS

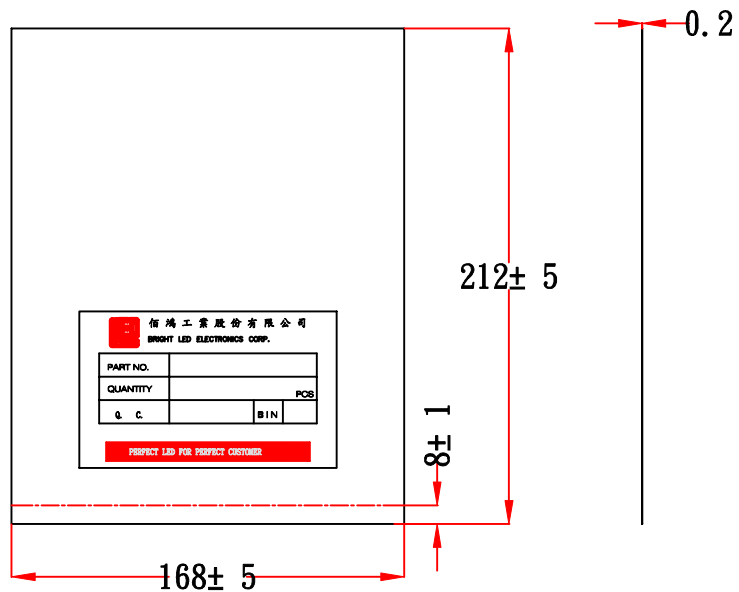

#### NOTES:

1. 1000 PCS PER BAG, 10K PCS PER BOX
2. ALL Dimensions are in millimeters(inches).
3. Specifications are subject to change without notice.