

Single Supply Quad Operational Amplifier with Full Swing Output

■ GENERAL DESCRIPTION

The NJM2747 is a quad low supply voltage operational amplifier with Full swing output.

The output full swing function provides wide dynamic range, is from ground to power supply level. And Input range rails from ground level.

It is suitable for audio section of portable sets, PCs and any General-purpose use.

■ FEATURES

- Operating Voltage 2.5V to 14V
- Output Full Swing $V_{OH} \geq 4.9V$ Typ. (at $V^+ = 5V, R_L = 5k\Omega$)
 $V_{OL} \leq 0.1V$ Typ. (at $V^+ = 5V, R_L = 5k\Omega$)
- Offset Voltage 1mV Typ
- Slew Rate 3.5V/ μ s Typ.
- Low Distortion 0.001% typ. (at $V^+ = 5V, f = 1kHz$)
- Low Input Voltage Noise 10nV/ \sqrt{Hz} typ.
- Bipolar Technology
- Package Outline

NJM2747D	DIP14
NJM2747M	DMP14
NJM2747E	EMP14
NJM2747V	SSOP14

■ PACKAGE OUTLINE

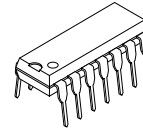

NJM2747D

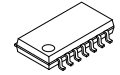

NJM2747M

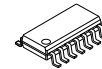

NJM2747E



NJM2747V

■ PIN CONFIGURATION

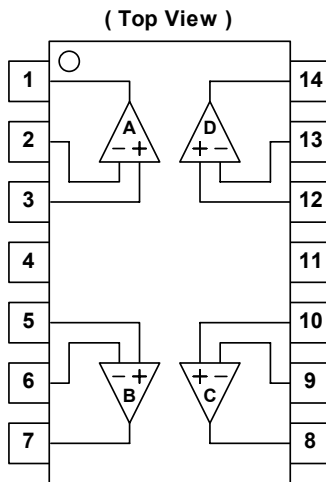

PIN FUNCTION

- | | |
|-------------|--------------|
| 1. OUTPUT A | 8. OUTPUT C |
| 2. -INPUT A | 9. -INPUT C |
| 3. +INPUT A | 10. +INPUT C |
| 4. V^+ | 11. GND |
| 5. +INPUT B | 12. +INPUT D |
| 6. -INPUT B | 13. -INPUT D |
| 7. OUTPUT B | 14. OUTPUT D |

NJM2747

www.DataSheet4U.com

■ ABSOLUTE MAXIMUM RATINGS

PARAMETER	SYMBOL	RATINGS	UNIT
Supply Voltage	V^+	15	V
Differential Input Voltage Range	V_{ID}	± 15 (Note1)	V
Common Mode Input Voltage Range	V_{ICM}	0 to 15 (Note1)	V
Power Dissipation	P_D	DIP14 870 DMP14 450(Note2) EMP14 720(Note2) 1200(Note4) SSOP14 420(Note2) 520(Note4)	mW
Operating Temperature Range	T_{opr}	-40 to +85	$^{\circ}\text{C}$
Storage Temperature Range	T_{stg}	-50 to +125	$^{\circ}\text{C}$

(Note1) For supply voltage less than 15V, the absolute maximum input voltage is equal to the supply voltage.

(Note2) On the PCB "EIA/JEDEC (76.2×114.3×1.6mm, two layers, FR-4)"

(Note3) On the PCB "EIA/JEDEC (76.2×114.3×1.6mm, four layers, FR-4)"

■ OPERATING VOLTAGE ($T_a=25^{\circ}\text{C}$)

PARAMETER	SYMBOL	RATINGS	UNIT
Supply Voltage	V^+	2.5 to 14	V

■ ELECTRICAL CHARACTERISTICS

●DC CHARACTERISTICS ($V^+=5\text{V}, T_a=25^{\circ}\text{C}$)

PARAMETER	SYMBOL	TEST CONDITION	MIN.	TYP.	MAX.	UNIT
Operating Current	I_{CC}	$R_L=\infty, V_{IN}=2.5\text{V}$, No Signal Apply	-	8	11	mA
Input Offset Voltage	V_{IO}	$R_S \leq 10\text{k}\Omega$	-	1	6	mV
Input Bias Current	I_B		-	100	350	nA
Input Offset Current	I_{IO}		-	5	100	nA
Large Signal Voltage Gain	A_V	$R_L \geq 10\text{k}\Omega$ to 2.5V, $V_o=0.5\text{V}$ to 4.5V	65	85	-	dB
Common Mode Rejection Ratio	CMR	$0\text{V} \leq V_{CM} \leq 4\text{V}$	60	75	-	dB
Supply Voltage Rejection Ratio	SVR	$V^+=2.5\text{V}$ to 14V	60	80	-	dB
Output Voltage	V_{OH}	$R_L=5\text{k}\Omega$ to 2.5V	4.75	4.9	-	V
	V_{OL}	$R_L=5\text{k}\Omega$ to 2.5V	-	0.1	0.25	V
Input Common Mode Voltage Range	V_{ICM}	CMR $\geq 60\text{dB}$	0	-	4	V

●AC CHARACTERISTICS ($V^+=5\text{V}, T_a=25^{\circ}\text{C}$)

PARAMETER	SYMBOL	TEST CONDITION	MIN.	TYP.	MAX.	UNIT
Unity Gain Bandwidth	GB	$f=10\text{kHz}$	-	10	-	MHz
Phase Margin	Φ_M	$R_L=10\text{k}\Omega, C_L=10\text{pF}$	-	75	-	Deg
Equivalent Input Noise Voltage	V_{NI}	$f=1\text{kHz}, V_{CM}=2.5\text{V}$	-	10	-	nV/ $\sqrt{\text{Hz}}$
Total Harmonic Distortion	THD	$f=1\text{kHz}, A_V=+2$ $R_L=10\text{k}\Omega$ to 2.5V, $V_o=1.5\text{Vrms}$	-	0.001	-	%
Amp to Amp Separation	CS	$f=1\text{kHz}$ $R_L=10\text{k}\Omega$ to 2.5V, $V_o=1.5\text{Vrms}$	-	120	-	dB

●AC CHARACTERISTICS ($V^+=5\text{V}, T_a=25^{\circ}\text{C}$)

PARAMETER	SYMBOL	TEST CONDITION	MIN.	TYP.	MAX.	UNIT
Slew Rate	SR	(Note 4), $A_V=1, V_{IN}=2\text{Vpp}$ $R_L=10\text{k}\Omega$ to 2.5V $C_L=10\text{pF}$ to 2.5V	-	3.5	-	V/ μs

(Note 4) Number specified is the slower of the positive and negative slew rates.

■ TYPICAL CHARACTERISTICS

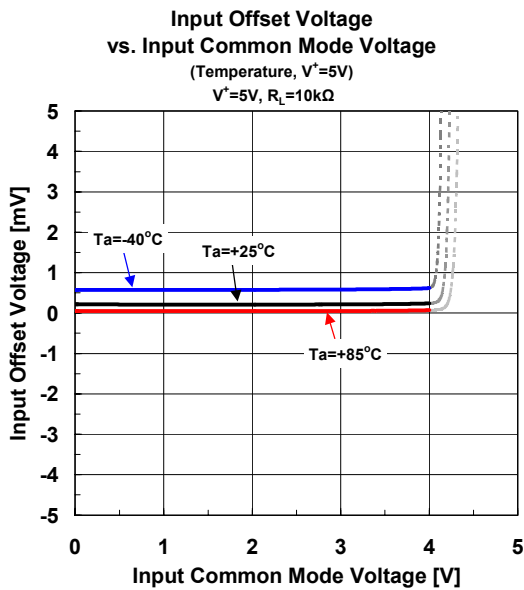
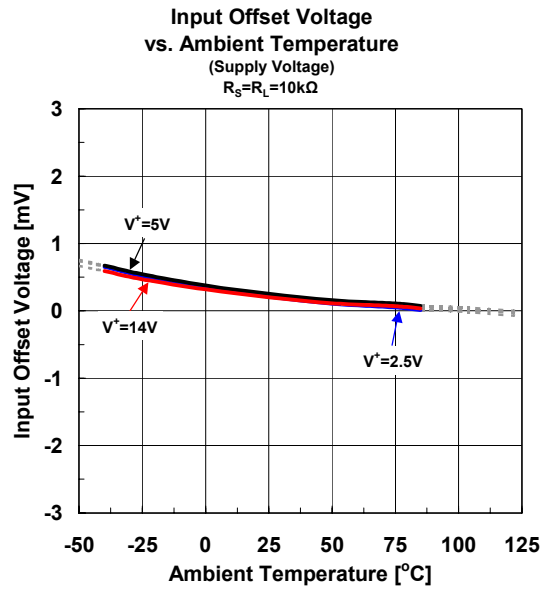
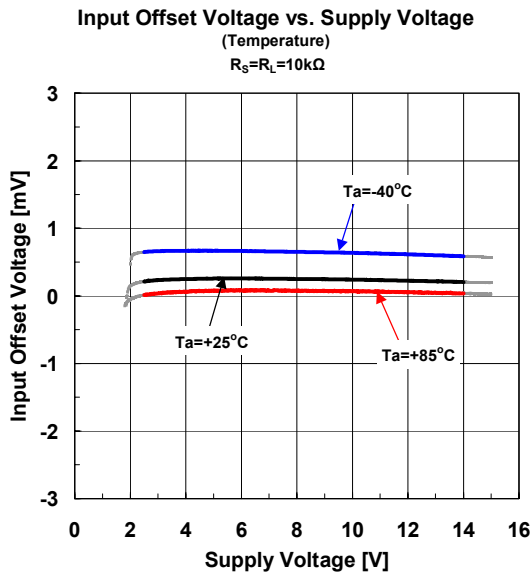
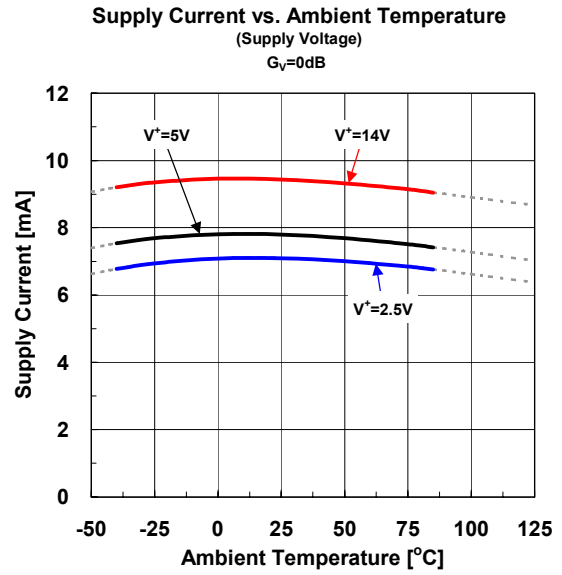
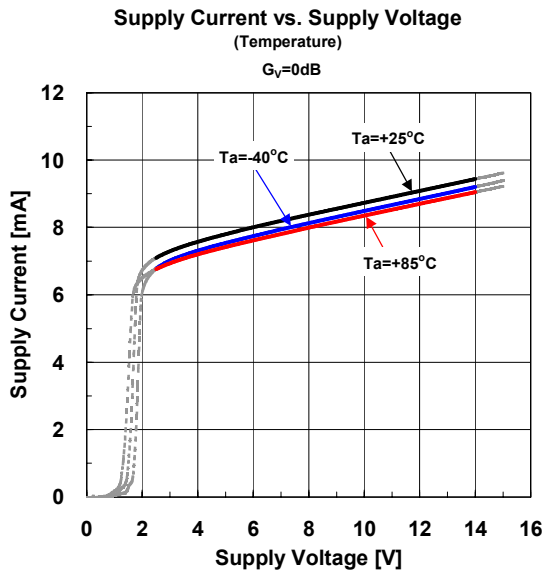

■ TYPICAL CHARACTERISTICS

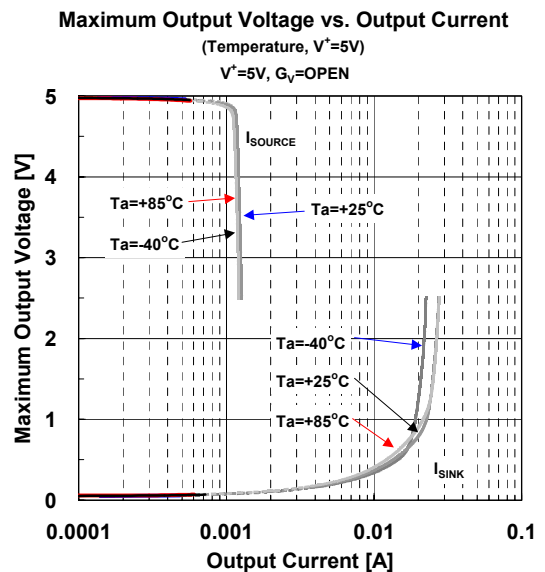
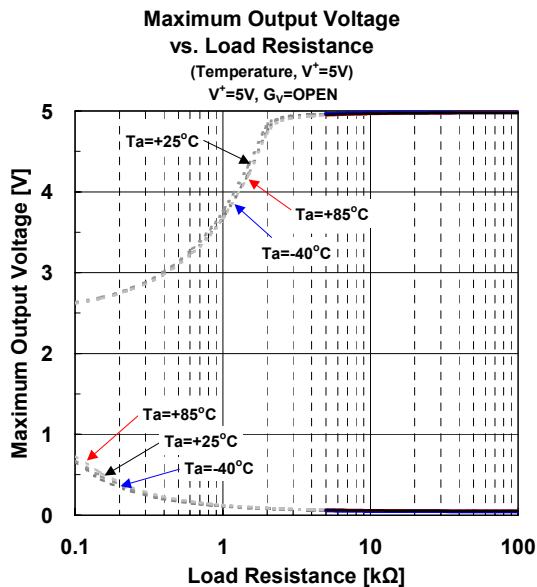
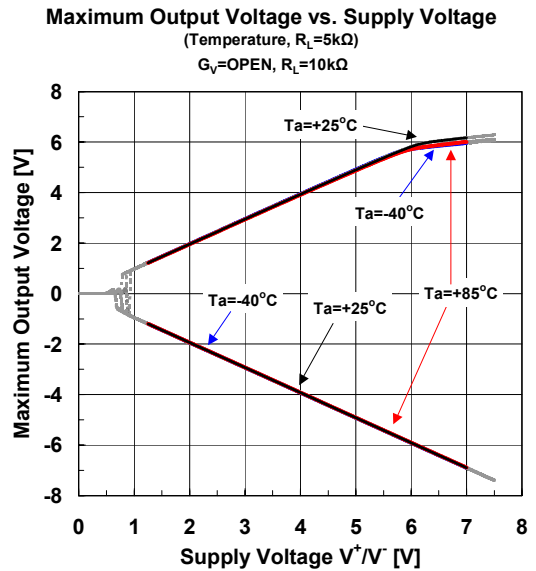
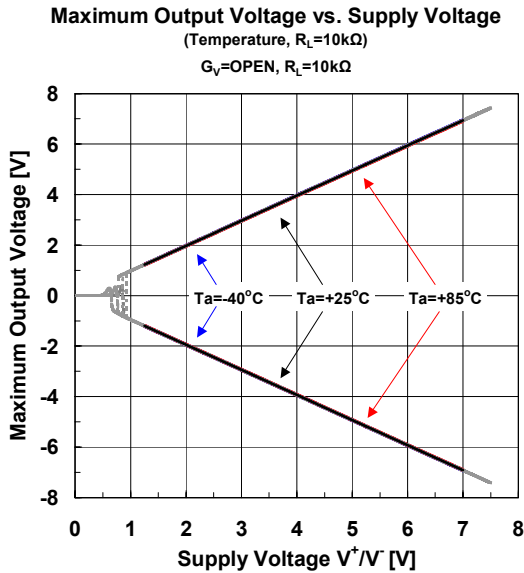
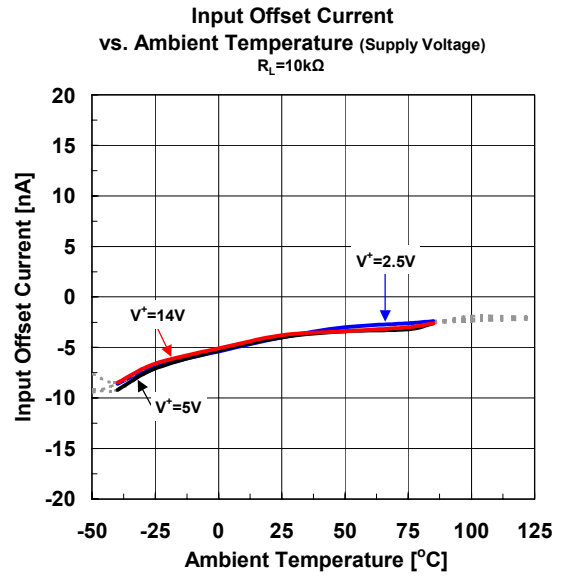
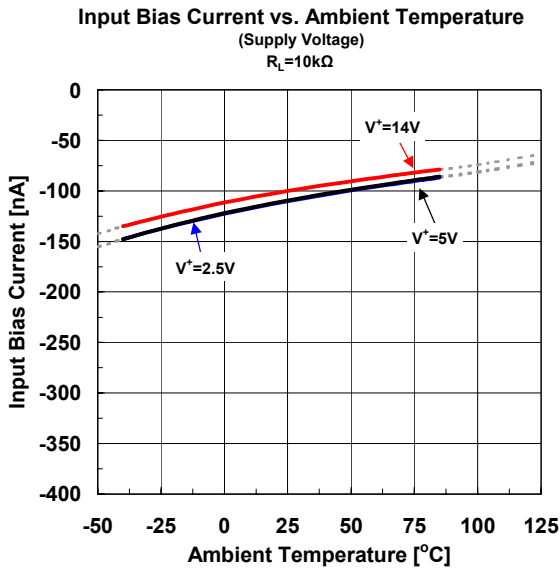

■ TYPICAL CHARACTERISTICS

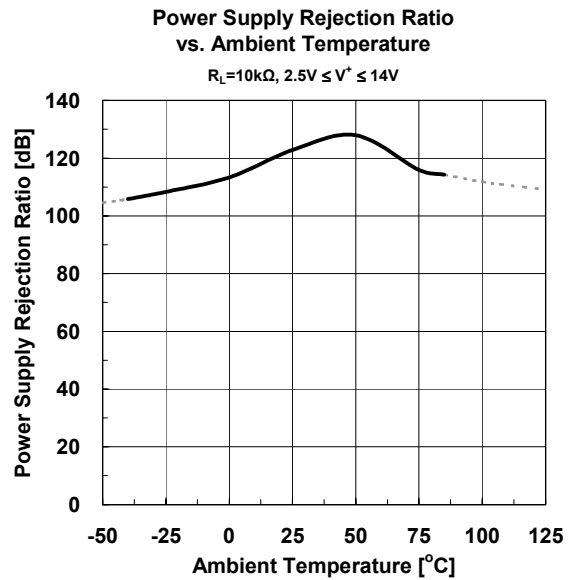
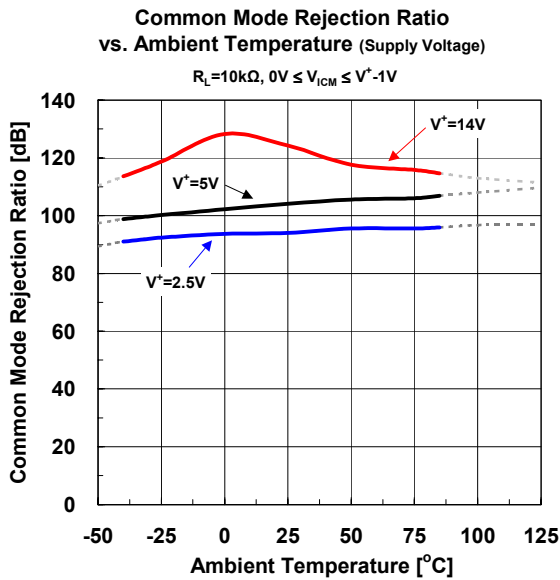
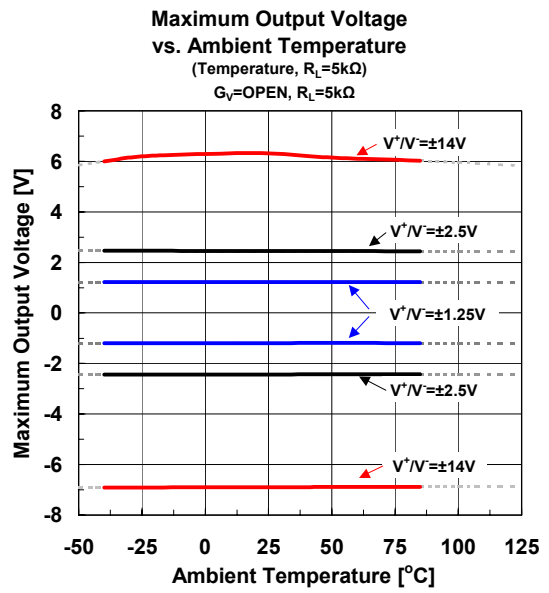
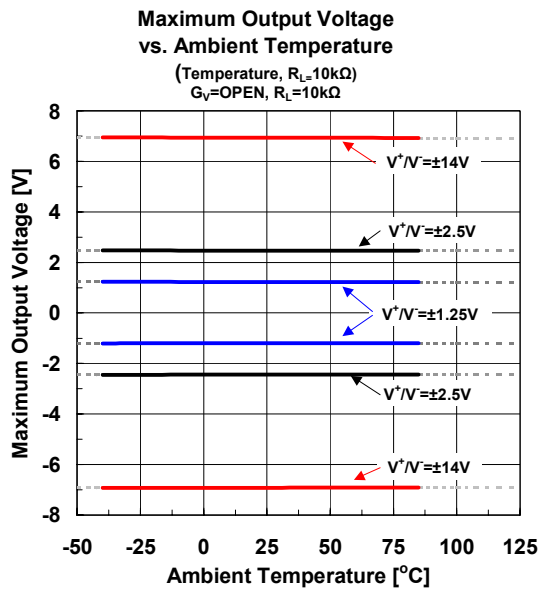

■ TYPICAL CHARACTERISTICS

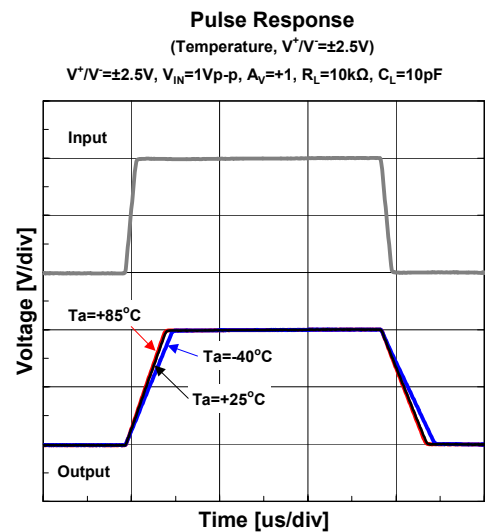
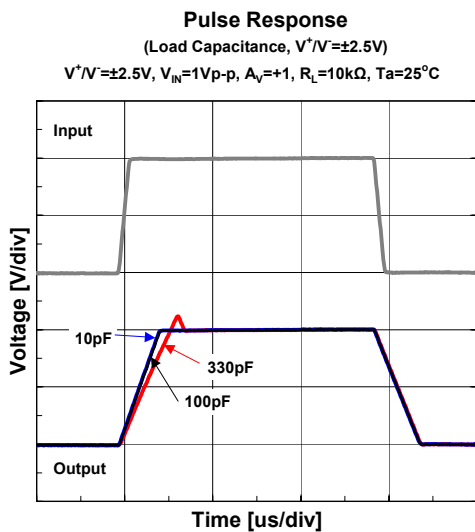
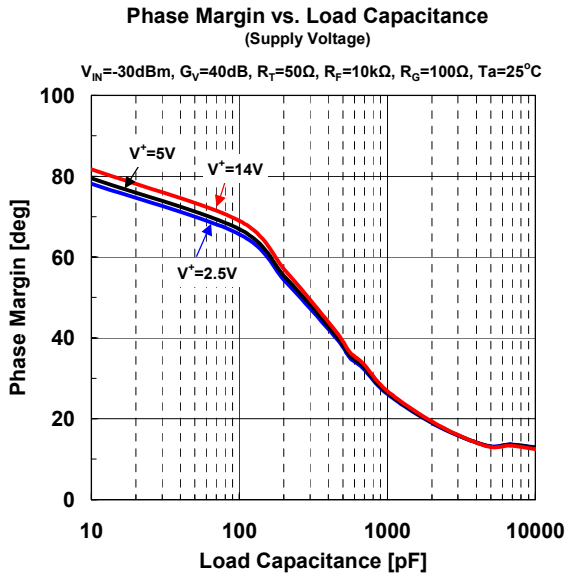
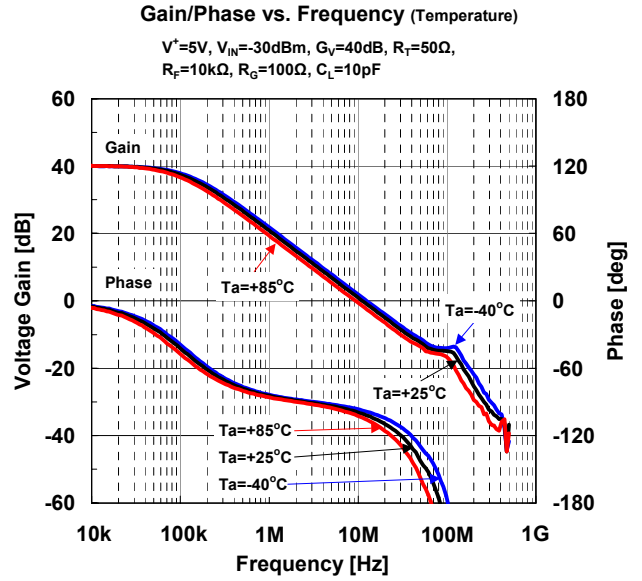
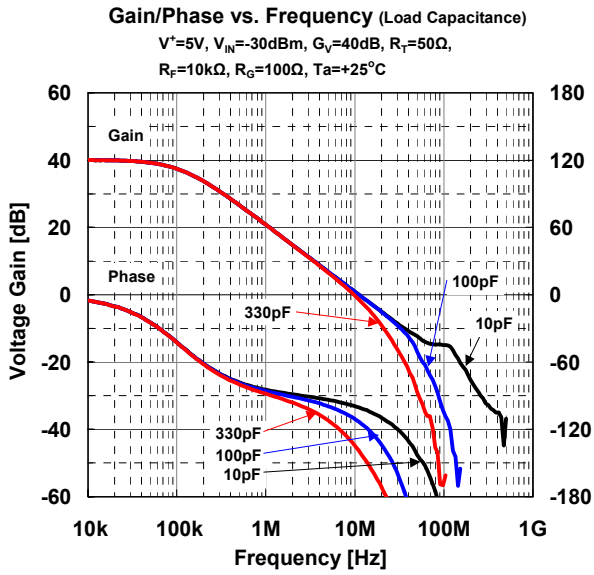

■ TYPICAL CHARACTERISTICS

THD+N vs. Output Voltage (Frequency)

$V^+ = 5V, A_v = +2, R_s = 600\Omega, R_f = 5k\Omega, R_G = 5k\Omega,$
 $BW = 10Hz \sim 80kHz, T_a = 25^\circ C$

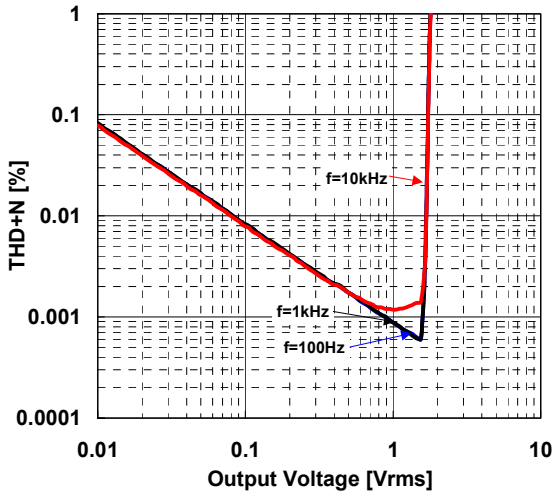

THD+N vs. Output Voltage (Supply Voltage)

$f = 1kHz, A_v = +2, R_s = 600\Omega, R_f = 5k\Omega, R_G = 5k\Omega,$
 $BW = 10Hz \sim 80kHz, T_a = 25^\circ C$

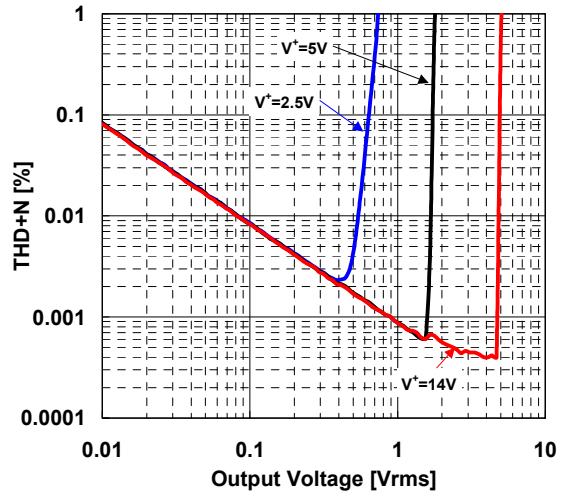

Equivalent Input Noise Voltage vs. Frequency (Supply Voltage)

$G_v = 60dB, R_i = 600\Omega, R_f = 100k\Omega, R_G = 100\Omega, T_a = 25^\circ C$

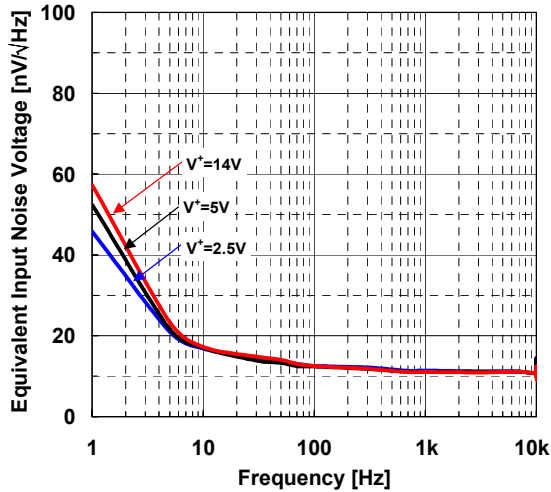

Channel Separation vs. Frequency

$V^+ = 5V, A_{ch} \text{ Input}, V_o = 1.5V_{rms}, G_v = 40dB, R_f = 100k\Omega,$
 $R_G = 1k\Omega, R_i = 10k\Omega, T_a = 25^\circ C$

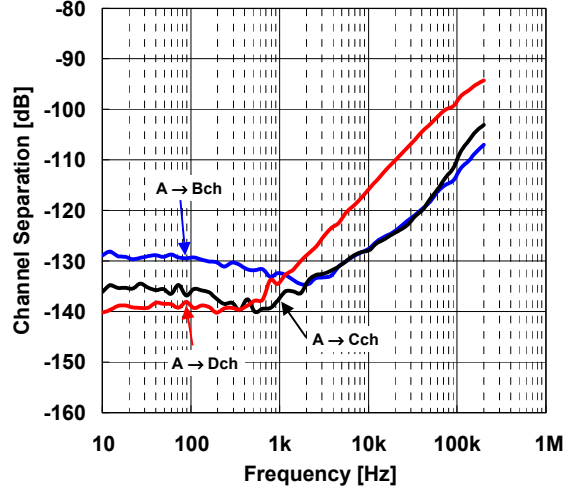

Channel Separation vs. Frequency

$V^+ = 5V, C_{ch} \text{ Input}, V_o = 1.5V_{rms}, G_v = 40dB, R_f = 100k\Omega,$
 $R_G = 1k\Omega, R_i = 10k\Omega, T_a = 25^\circ C$

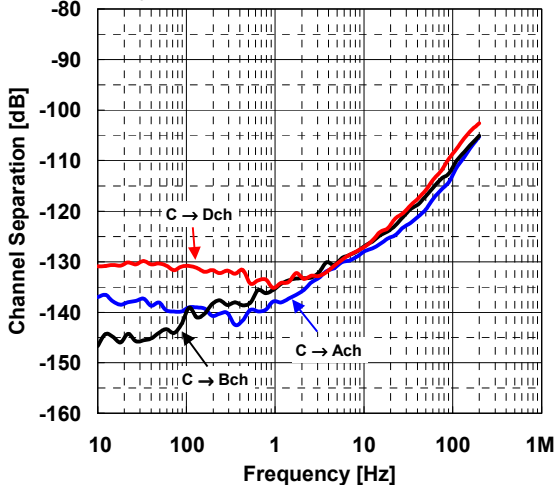

NJM2747

www.DataSheet4U.com

■ MEMO

[CAUTION]

The specifications on this data book are only given for information, without any guarantee as regards either mistakes or omissions. The application circuits in this data book are described only to show representative usages of the product and not intended for the guarantee or permission of any right including the industrial rights.