

TOSHIBA FIELD EFFECT TRANSISTOR SILICON N CHANNEL MOS TYPE (π -MOSV)

2SK2953

HIGH SPEED, HIGH CURRENT SWITCHING APPLICATIONS

CHOPPER REGULATOR, DC-DC CONVERTER AND MOTOR DRIVE APPLICATIONS

- Low Drain-Source ON Resistance : $R_{DS(ON)} = 0.31\Omega$ (Typ.)
- High Forward Transfer Admittance : $|Y_{fs}| = 15S$ (Typ.)
- Low Leakage Current : $I_{DSS} = 100\mu A$ (Max.) ($V_{DS} = 600V$)
- Enhancement-Mode : $V_{th} = 2.0 \sim 4.0V$ ($V_{DS} = 10V$, $I_D = 1mA$)

MAXIMUM RATINGS ($T_a = 25^\circ C$)

CHARACTERISTIC	SYMBOL	RATING	UNIT
Drain-Source Voltage	V_{DSS}	600	V
Drain-Gate Voltage ($R_{GS} = 20k\Omega$)	V_{DGR}	600	V
Gate-Source Voltage	V_{GSS}	± 30	V
Drain Current	DC	I_D	15
	Pulse	I_{DP}	60
Drain Power Dissipation ($T_c = 25^\circ C$)	P_D	90	W
Single Pulse Avalanche Energy**	E_{AS}	1026	mJ
Avalanche Current	I_{AR}	15	A
Repetitive Avalanche Energy*	E_{AR}	9	mJ
Channel Temperature	T_{ch}	150	$^\circ C$
Storage Temperature Range	T_{stg}	$-55 \sim 150$	$^\circ C$

THERMAL CHARACTERISTICS

CHARACTERISTIC	SYMBOL	MAX.	UNIT
Thermal Resistance, Channel to Case	$R_{th(ch-c)}$	1.39	$^\circ C/W$
Thermal Resistance, Channel to Ambient	$R_{th(ch-a)}$	41.6	$^\circ C/W$

Note ;

* Repetitive rating ; Pulse Width Limited by Max. junction temperature.

** $V_{DD} = 90V$, Starting $T_{ch} = 25^\circ C$, $L = 7.98mH$, $R_G = 25\Omega$, $I_{AR} = 15A$ **This transistor is an electrostatic sensitive device.****Please handle with caution.**

INDUSTRIAL APPLICATIONS

Unit in mm

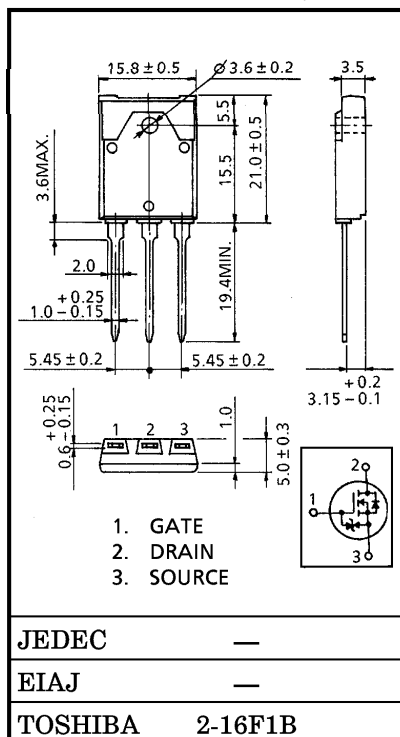

Weight : 5.8g (Typ.)

961001EAA1

- TOSHIBA is continually working to improve the quality and the reliability of its products. Nevertheless, semiconductor devices in general can malfunction or fail due to their inherent electrical sensitivity and vulnerability to physical stress. It is the responsibility of the buyer, when utilizing TOSHIBA products, to observe standards of safety, and to avoid situations in which a malfunction or failure of a TOSHIBA product could cause loss of human life, bodily injury or damage to property. In developing your designs, please ensure that TOSHIBA products are used within specified operating ranges as set forth in the most recent products specifications. Also, please keep in mind the precautions and conditions set forth in the TOSHIBA Semiconductor Reliability Handbook.
- The information contained herein is presented only as a guide for the applications of our products. No responsibility is assumed by TOSHIBA CORPORATION for any infringements of intellectual property or other rights of the third parties which may result from its use. No license is granted by implication or otherwise under any intellectual property or other rights of TOSHIBA CORPORATION or others.
- The information contained herein is subject to change without notice.

ELECTRICAL CHARACTERISTICS (Ta = 25°C)

CHARACTERISTIC		SYMBOL	TEST CONDITION	MIN.	TYP.	MAX.	UNIT
Gate Leakage Current		I_{GSS}	$V_{GS} = \pm 25V, V_{DS} = 0V$	—	—	± 10	μA
Gate-Source Breakdown Voltage		$V_{(BR)GSS}$	$I_G = \pm 10\mu A, V_{DS} = 0V$	± 30	—	—	V
Drain Cut-off Current		I_{DSS}	$V_{DS} = 600V, V_{GS} = 0V$	—	—	100	μA
Drain-Source Breakdown Voltage		$V_{(BR)DSS}$	$I_D = 10mA, V_{GS} = 0V$	600	—	—	V
Gate Threshold Voltage		V_{th}	$V_{DS} = 10V, I_D = 1mA$	2.0	—	4.0	V
Drain-Source ON Resistance		$R_{DS(ON)}$	$V_{GS} = 10V, I_D = 8.0A$	—	0.31	0.4	Ω
Forward Transfer Admittance		$ Y_{fs} $	$V_{DS} = 10V, I_D = 8.0A$	8.0	15.0	—	S
Input Capacitance		C_{iss}	$V_{DS} = 25V, V_{GS} = 0V, f = 1MHz$	—	3520	—	pF
Reverse Transfer Capacitance		C_{rss}		—	20	—	
Output Capacitance		C_{oss}		—	300	—	
Switching Time	Rise Time	t_r	<p>$V_{GS} = 10V$ $I_D = 8.0A$ $R_L = 37.5\Omega$ $V_{DD} \approx 300V$</p>	—	50	—	ns
	Turn-on Time	t_{on}		—	100	—	
	Fall Time	t_f		—	60	—	
	Turn-off Time	t_{off}		$V_{IN} : t_r, t_f < 5ns,$ $Duty \leq 1\%, t_w = 10\mu s$	—	325	
Total Gate Charge (Gate-Source Plus Gate-Drain)		Q_g	$V_{DD} \approx 400V, V_{GS} = 10V,$ $I_D = 15A$	—	80	—	nC
Gate-Source Charge		Q_{gs}		—	48	—	
Gate-Drain ("Miller") Charge		Q_{gd}		—	32	—	

SOURCE-DRAIN DIODE RATINGS AND CHARACTERISTICS (Ta = 25°C)

CHARACTERISTIC	SYMBOL	TEST CONDITION	MIN.	TYP.	MAX.	UNIT
Continuous Drain Reverse Current	I_{DR}	—	—	—	15	A
Pulse Drain Reverse Current	I_{DRP}	—	—	—	60	A
Diode Forward Voltage	V_{DSF}	$I_{DR} = 15A, V_{GS} = 0V$	—	—	-1.7	V
Reverse Recovery Time	t_{rr}	$I_{DR} = 15A, V_{GS} = 0V$	—	620	—	ns
Reverse Recovery Charge	Q_{rr}	$dI_{DR} / dt = 100A / \mu s$	—	7.5	—	μC

MARKING

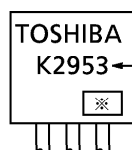

TYPE

※ Lot Number

□ □ — Month (Starting from Alphabet A)

— Year (Last Number of the Christian Era)

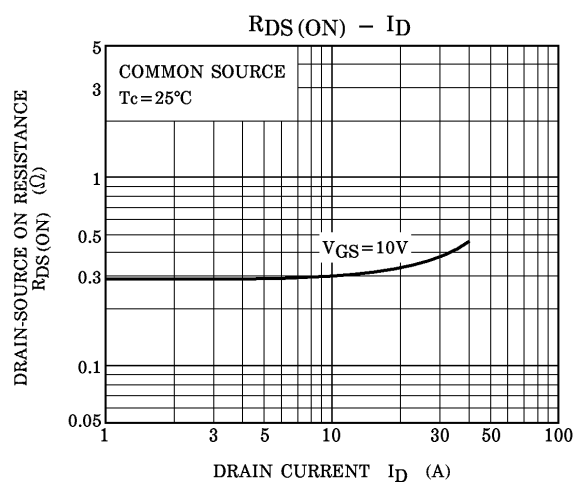
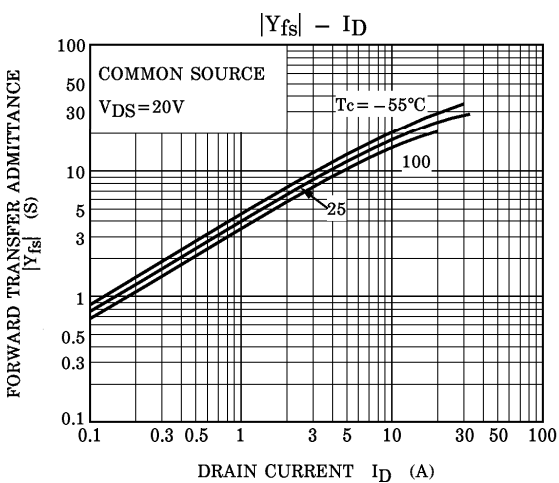
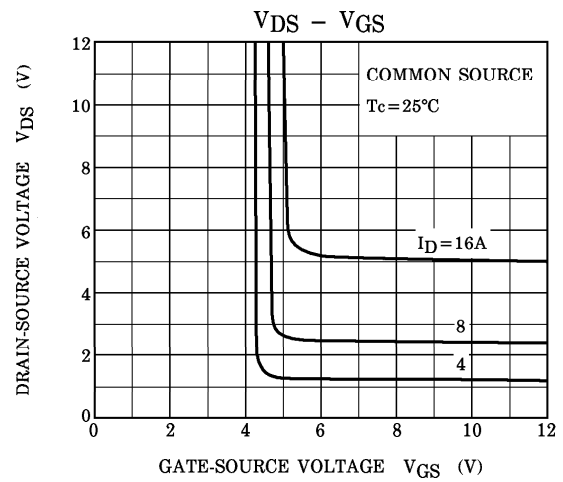
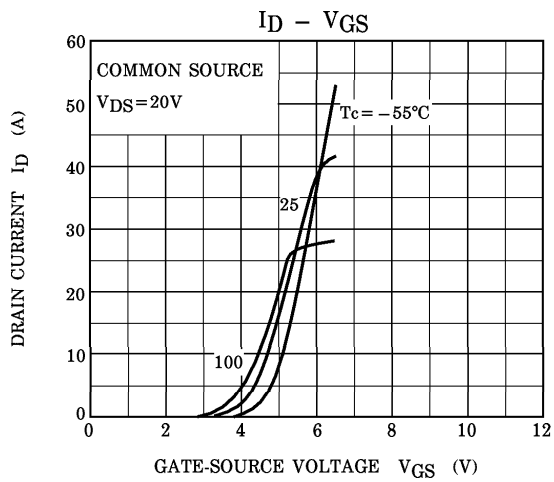
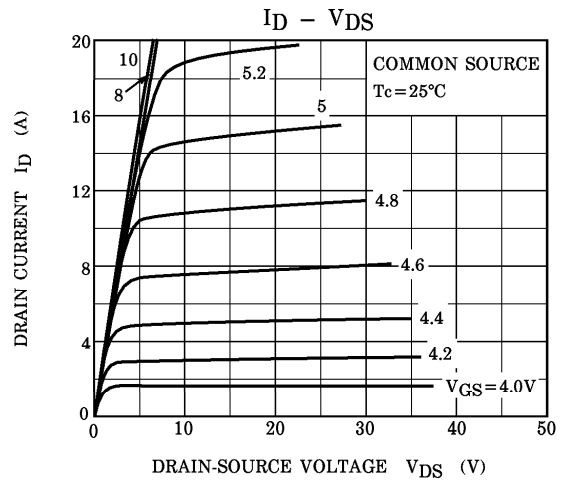
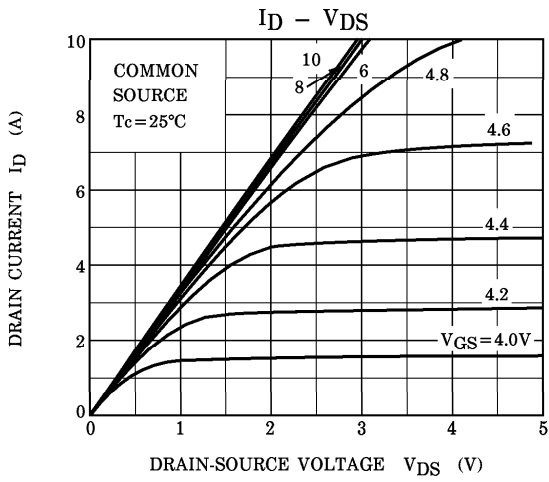

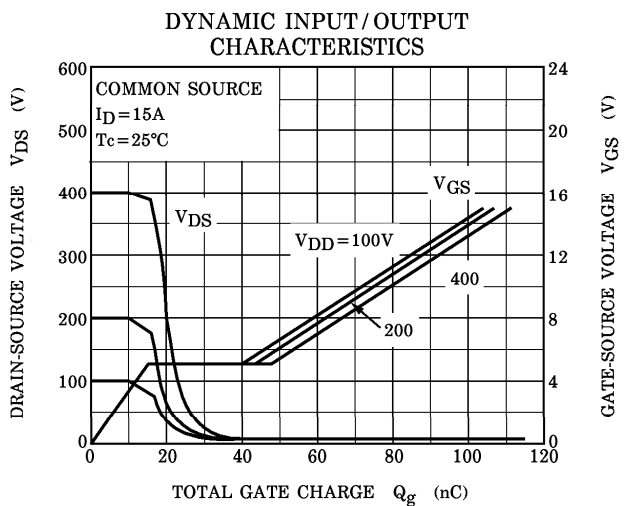
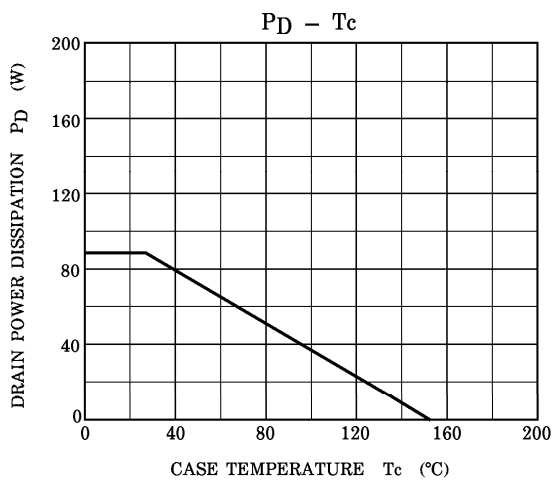
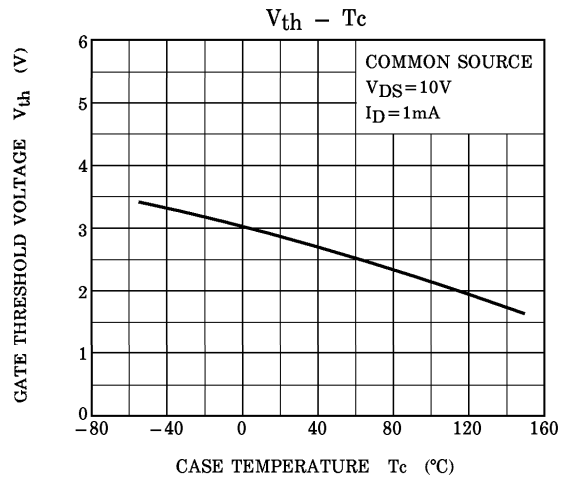
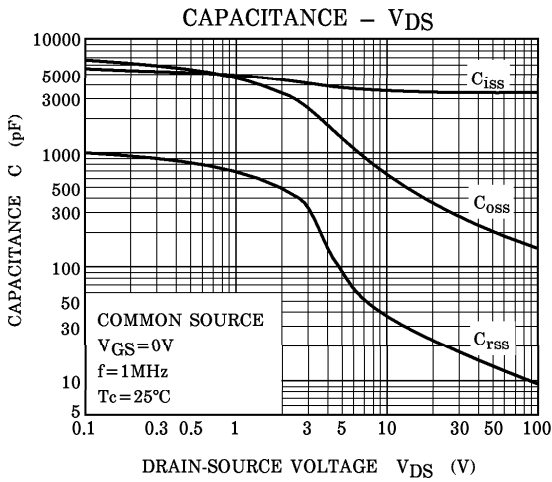
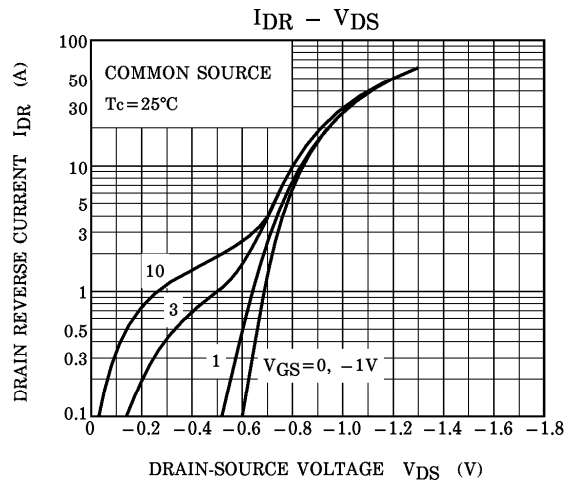
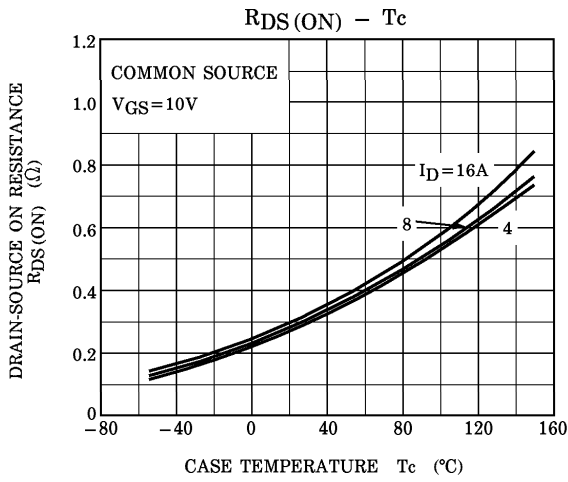

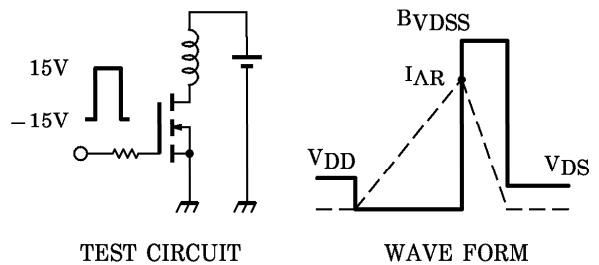
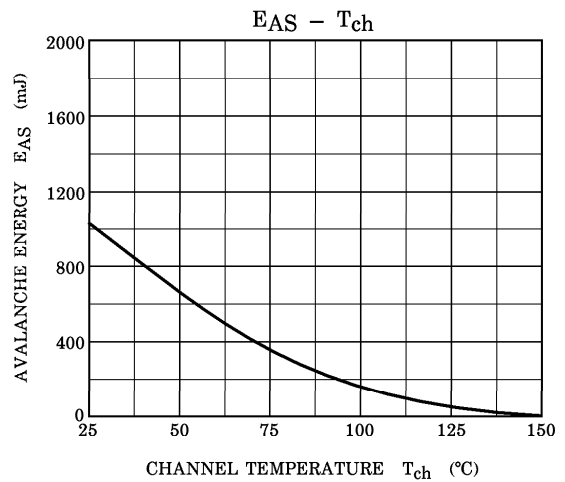
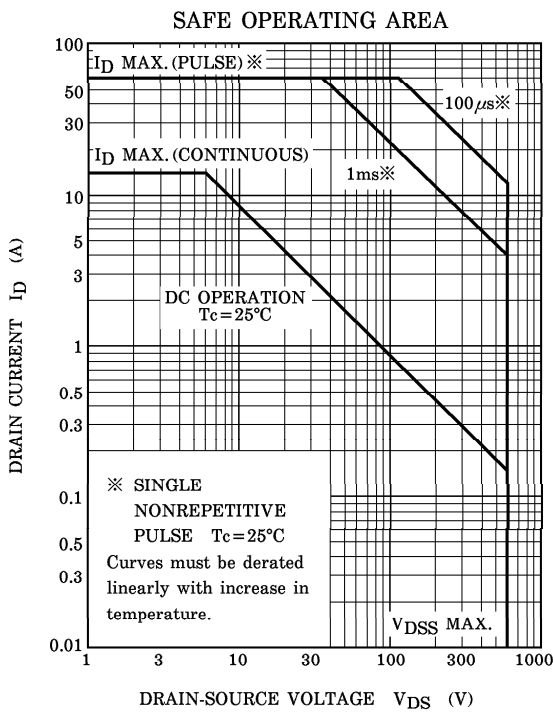
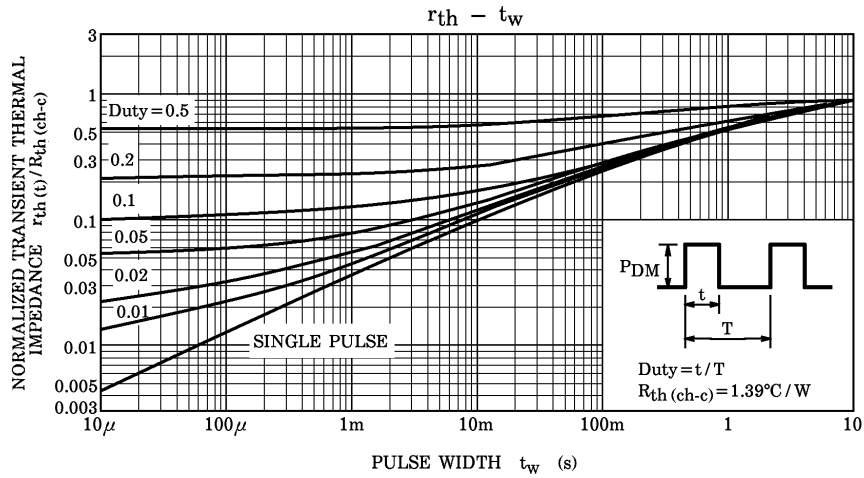

Peak $I_{AR} = 15A$, $R_G = 25\Omega$ $E_{AS} = \frac{1}{2} \cdot L \cdot I^2 \cdot \left(\frac{BVDSS}{BVDSS - V_{DD}} \right)$
 $V_{DD} = 90V$, $L = 7.98mH$