



# TSL1014

## 14 + 1 channel buffers for TFT-LCD panels

### Features

- Wide supply voltage: 5.5 V to 16.8 V
- Low operating current: 6 mA typical at 25° C
- Gain bandwidth product: 1 MHz
- High current com amplifier:  $\pm 100$  mA output current
- Industrial temperature range: -40° C to +85° C
- Small package: TQFP48
- Automotive qualification

### Application

- TFT liquid crystal display (LCD)

### Description

The TSL1014 is composed of 14 + 1 channel buffers which are used to buffer the reference voltage for gamma correction in thin film transistor (TFT) liquid crystal displays (LCD).

One "COM" amplifier is able to deliver high output current value, up to  $\pm 100$ mA. Amplifiers A and B feature positive single supply inputs for common mode voltage behavior. The amplifiers C to N inclusive, and the COM amplifier, feature negative single-supply inputs and are dedicated to the highest and lowest gamma voltages.

The TSL1014 is fully characterized and guaranteed over a wide industrial temperature range (-40 to +85° C).

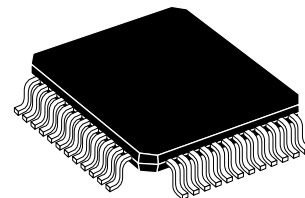

7 x 7mm TQFP48

### Pin connections (top view)

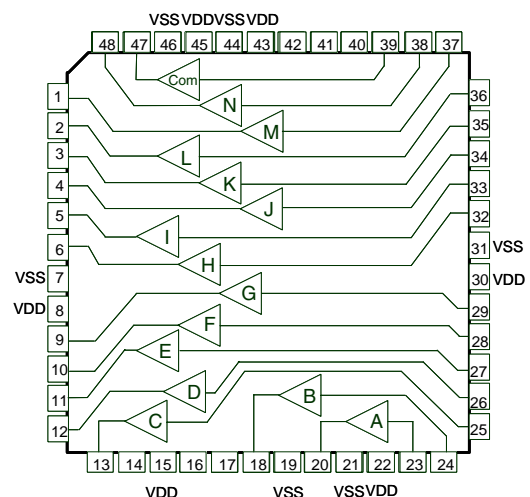

# 1 Absolute maximum ratings and operating conditions

**Table 1. Absolute maximum ratings**

Symbol	Parameter	Value	Unit
V <sub>CC</sub>	Supply voltage (V <sub>DD</sub> -V <sub>SS</sub> )	18	V
V <sub>IN</sub>	Input voltage	V <sub>SS</sub> -0.5V to V <sub>DD</sub> +0.5V	V
I <sub>OUT</sub>	Output current (A to N buffers) Output current (Com buffer)	30 100	mA
I <sub>SC</sub>	Short circuit current (A to N buffers) Short circuit current (Com buffer)	±120 ±300	mA
P <sub>D</sub>	Power dissipation <sup>(1)</sup> for TQFP48	1470	mW
R <sub>THJA</sub>	Thermal resistance junction to ambient for TQFP48	85	°C/W
T <sub>LEAD</sub>	Lead temperature (soldering 10 seconds)	260	°C
T <sub>STG</sub>	Storage temperature	-65 to +150	°C
T <sub>J</sub>	Junction temperature	150	°C
ESD	Human body model (HBM) <sup>(2)</sup>	2000	V
	Machine model (MM) <sup>(3)</sup>	200	
	Charged device model (CDM) <sup>(4)</sup>	1500	

1. P<sub>D</sub> is calculated with T<sub>amb</sub> = 25° C, T<sub>J</sub> = 150° C and R<sub>THJA</sub> = 85° C/W for the TQFP48 package.
2. Human body model: a 100 pF capacitor is charged to the specified voltage, then discharged through a 1.5 kΩ resistor between two pins of the device. This is done for all couples of connected pin combinations while the other pins are floating.
3. Machine model: a 200 pF capacitor is charged to the specified voltage, then discharged directly between two pins of the device with no external series resistor (internal resistor < 5 Ω). This is done for all couples of connected pin combinations while the other pins are floating.
4. Charged device model: all pins and package are charged together to the specified voltage and then discharged directly to the ground through only one pin.

**Table 2. Operating conditions**

Symbol	Parameter	Value	Unit
V <sub>CC</sub>	Supply voltage (V <sub>DD</sub> -V <sub>SS</sub> )	5.5 to 16.8	V
T <sub>amb</sub>	Ambient temperature	-40 to +85	°C
V <sub>IN</sub>	Input voltage (Buffers A & B)	V <sub>SS</sub> +1.5V to V <sub>DD</sub>	V
	Input voltage (Buffers C to N + COM)	V <sub>SS</sub> to V <sub>DD</sub> -1.5V	

## 2 Typical application schematics

Figure 1. A typical application schematic for the TSL1014

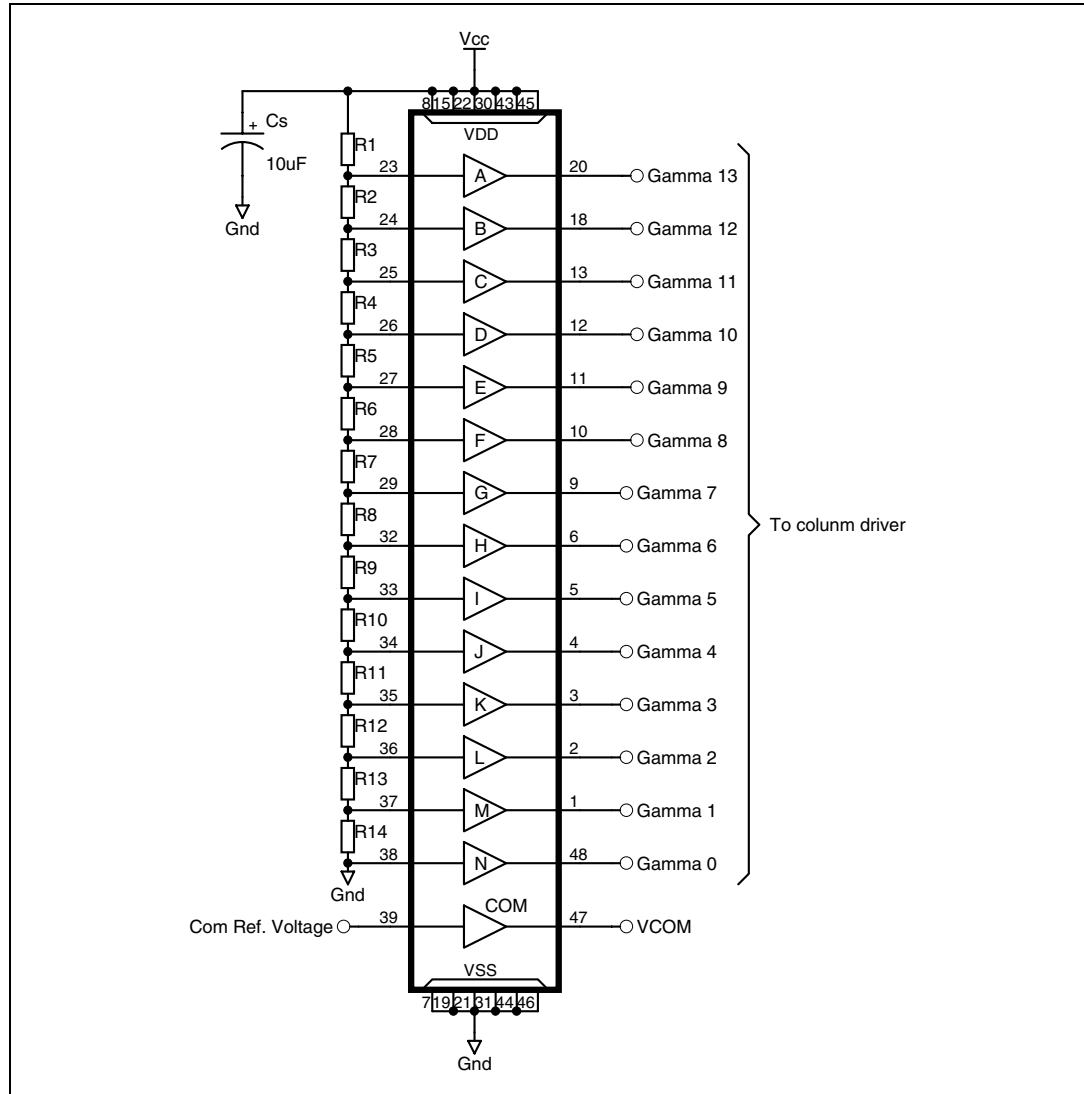

Note that:

- Amplifiers **A & B** have their input voltage in the range  $V_{SS}+1.5\text{ V}$  to  $V_{DD}$ . This is why they must be used for high level gamma correction voltages.
- Amplifiers **C to N** have their input voltage in the range  $V_{SS}$  to  $V_{DD}-1.5\text{ V}$ . This is why they must be used for medium-to-low level gamma correction voltages.
- Amplifier **COM** has its input voltage range from  $V_{SS}$  to  $V_{DD}-1.5\text{ V}$ .

### 3 Electrical characteristics

**Table 3. Electrical characteristics for TSL1014IF/TSL1014IFT**  
 $T_{amb} = 25^{\circ}\text{C}$ ,  $V_{DD} = +5\text{V}$ ,  $V_{SS} = -5\text{V}$ ,  $R_L = 10\text{k}\Omega$ ,  $C_L = 10\text{pF}$  (unless otherwise specified)

Symbol	Parameter	Test conditions	Min.	Typ.	Max.	Unit
$V_{IO}$	Input offset voltage	$V_{ICM} = 0\text{V}$			12	mV
$\Delta V_{IO}$	Input offset voltage drift	$T_{Min} < T_{amb} < T_{Max}$		5		$\mu\text{V}/^{\circ}\text{C}$
$I_{IB}$	Input bias current	$V_{ICM} = 0\text{V}$ , buffers A & B $V_{ICM} = 0\text{V}$ , buffers C to N & COM			140 70	nA
$R_{IN}$	Input impedance			1		$\text{G}\Omega$
$C_{IN}$	Input capacitance			1.35		pF
$V_{OL}$	Output voltage low	$I_{OUT} = -5\text{mA}$ Buffers C to L Buffers M, N & COM		-4.85 -4.92	-4.80 -4.85	V
$V_{OH}$	Output voltage high	$I_{OUT} = 5\text{mA}$ for positive single-supply buffers (A & B)	4.82	4.87		V
$I_{OUT}$	Output current	(A to N buffers)		$\pm 30$		mA
		Com buffer		$\pm 100$		
PSRR	Power supply rejection ratio	$V_{CC} = 6.5$ to $15.5\text{V}$	80	100		dB
$I_{CC}$	Supply current	No load		6	8.4	mA
SR	Slew rate (rising & falling edge)	$-4\text{V} < V_{OUT} < +4\text{V}$ 20% to 80%		1		$\text{V}/\mu\text{s}$
$t_s$	Settling time	Settling to 0.1%, $V_{OUT} = 2\text{V}$ step		5		$\mu\text{s}$
BW	Bandwidth at -3dB	$R_L = 10\text{k}\Omega$ , $C_L = 10\text{pF}$		2		MHz
$G_m$	Phase margin	$R_L = 10\text{k}\Omega$ , $C_L = 10\text{pF}$		60		degrees
$C_s$	Channel separation	$f = 1\text{MHz}$		75		dB

*Note: Limits are 100% production tested at 25°C. Behavior at the temperature range limits is guaranteed through correlation and by design.*

**Table 4. Electrical characteristics for TSL1014IYF/TSL1014IYFT (automotive grade)**  
 $T_{amb} = 25^{\circ}\text{C}$ ,  $V_{DD} = +5\text{V}$ ,  $V_{SS} = -5\text{V}$ ,  $R_L = 10\text{k}\Omega$ ,  $C_L = 10\text{pF}$  (unless otherwise specified)

Symbol	Parameter	Test conditions	Min.	Typ.	Max.	Unit
$V_{IO}$	Input offset voltage	$V_{ICM} = 0\text{V}$ $T_{Min} < T_{amb} < T_{Max}$			12	mV
$\Delta V_{IO}$	Input offset voltage drift	$T_{Min} < T_{amb} < T_{Max}$		5		$\mu\text{V}/^{\circ}\text{C}$
$I_{IB}$	Input bias current	$V_{ICM} = 0\text{V}$ , buffers A & B $T_{Min} < T_{amb} < T_{Max}$  $V_{ICM} = 0\text{V}$ , buffers C to N & COM $T_{Min} < T_{amb} < T_{Max}$			140 280  70 140	nA
$R_{IN}$	Input impedance			1		$\text{G}\Omega$
$C_{IN}$	Input capacitance			1.35		pF
$V_{OL}$	Output voltage low	$I_{OUT} = -5\text{mA}$ Buffers C to L $T_{Min} < T_{amb} < T_{Max}$  Buffers M, N & COM $T_{Min} < T_{amb} < T_{Max}$		-4.85  -4.92	-4.80 -4.76  -4.85 -4.83	V
$V_{OH}$	Output voltage high	$I_{OUT} = 5\text{mA}$ for positive single-supply buffers (A & B) $T_{Min} < T_{amb} < T_{Max}$	4.82 4.80	4.87		V
$I_{OUT}$	Output current	(A to N buffers) Com buffer		$\pm 30$ $\pm 100$		mA
PSRR	Power supply rejection ratio	$V_{CC} = 6.5$ to $15.5\text{V}$ $T_{Min} < T_{amb} < T_{Max}$	80	100		dB
$I_{CC}$	Supply current	No load $T_{Min} < T_{amb} < T_{Max}$		6	8.4 9	mA
SR	Slew rate (rising & falling edge)	$-4\text{V} < V_{OUT} < +4\text{V}$ 20% to 80%		1		$\text{V}/\mu\text{s}$
$t_s$	Settling time	Settling to 0.1%, $V_{OUT} = 2\text{V}$ step		5		$\mu\text{s}$
BW	Bandwidth at -3dB	$R_L = 10\text{k}\Omega$ , $C_L = 10\text{pF}$		2		MHz
$G_m$	Phase margin	$R_L = 10\text{k}\Omega$ , $C_L = 10\text{pF}$		60		degrees
$C_s$	Channel separation	$f = 1\text{MHz}$		75		dB

Note: Limits are 100% production tested at  $25^{\circ}\text{C}$ . Behavior at the temperature range limits is guaranteed through correlation and by design.

Figure 2. Supply current vs. supply voltage for various temperatures

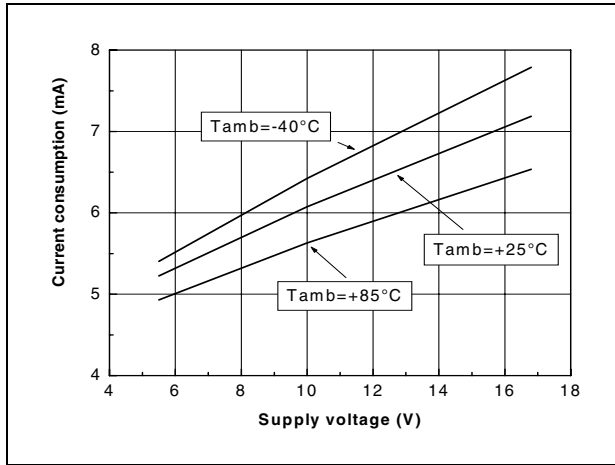

Figure 3. Output offset voltage (eq.  $V_{IO}$ ) vs. temperature

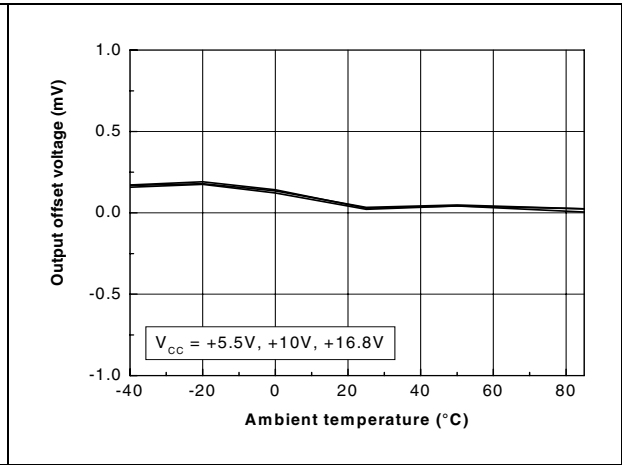

Figure 4. Input current ( $I_{IB}$ ) vs. temperature

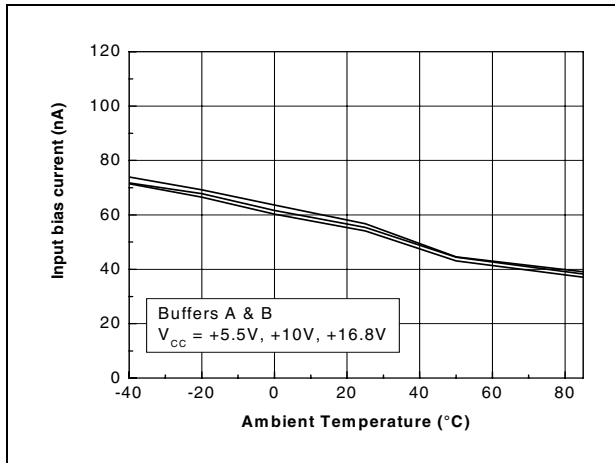

Figure 5. Input current ( $I_{IB}$ ) vs. temperature

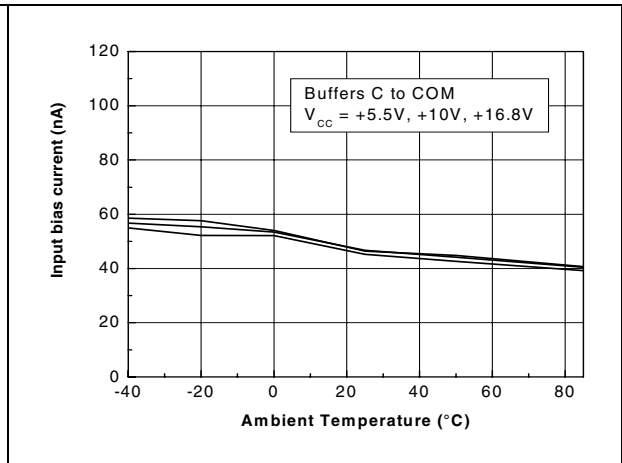

Figure 6. Output current capability vs. temperature

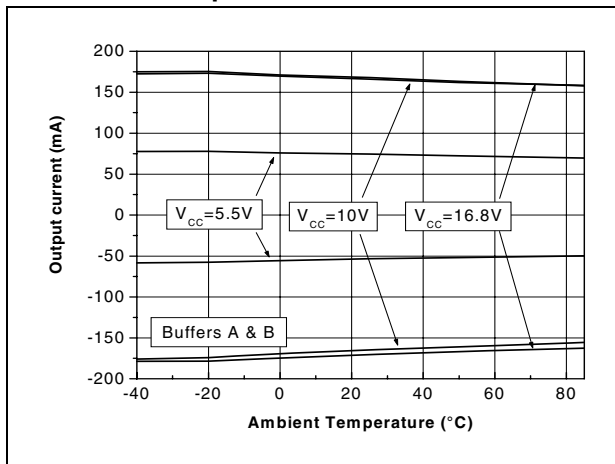

Figure 7. Output current capability vs. temperature

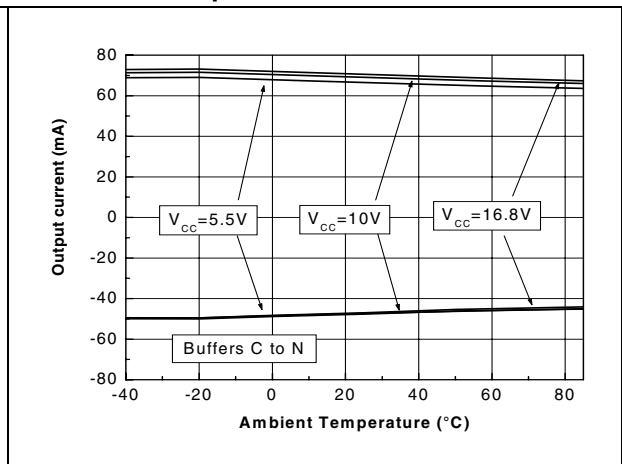

Figure 8. Output current capability vs. temperature

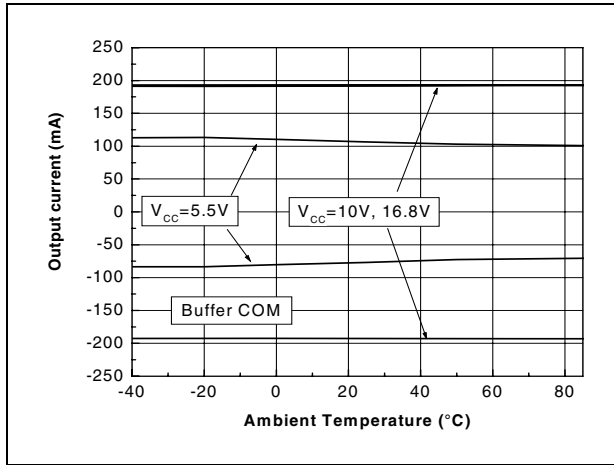

Figure 9. High level voltage drop vs. temperature

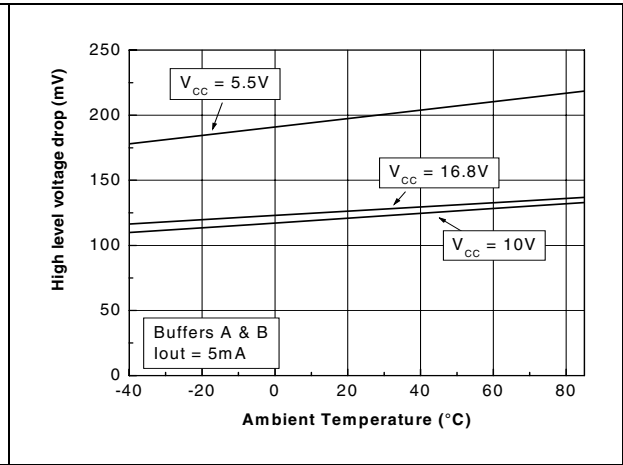

Figure 10. Low level voltage drop vs. temperature

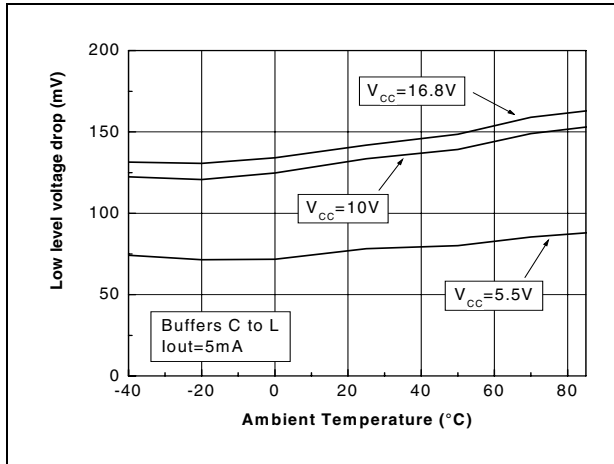

Figure 11. Low level voltage drop vs. temperature

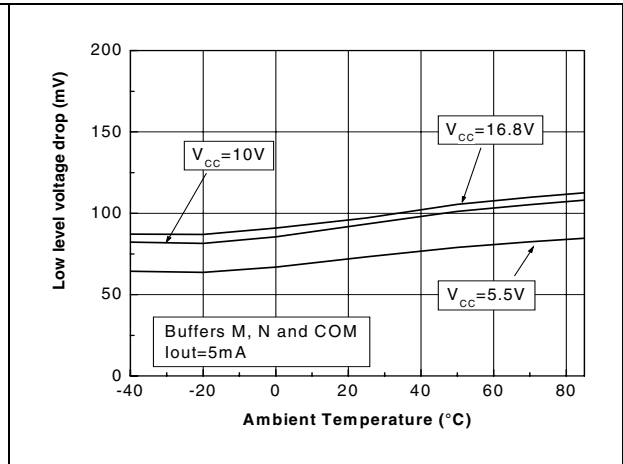

Figure 12. Voltage output high (VOH) vs. output current - Buffers A & B

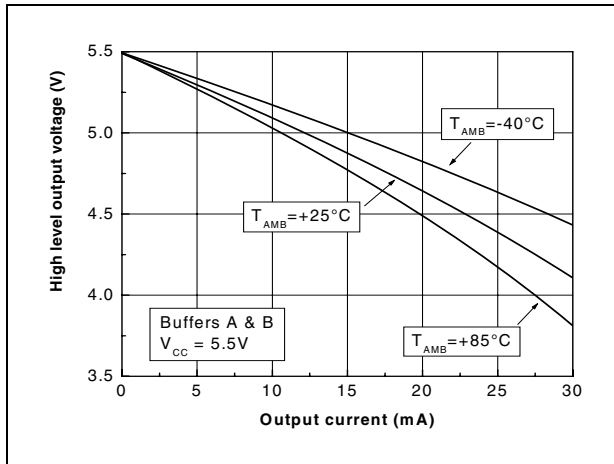

Figure 13. Voltage output high (VOH) vs. output current - Buffers A & B

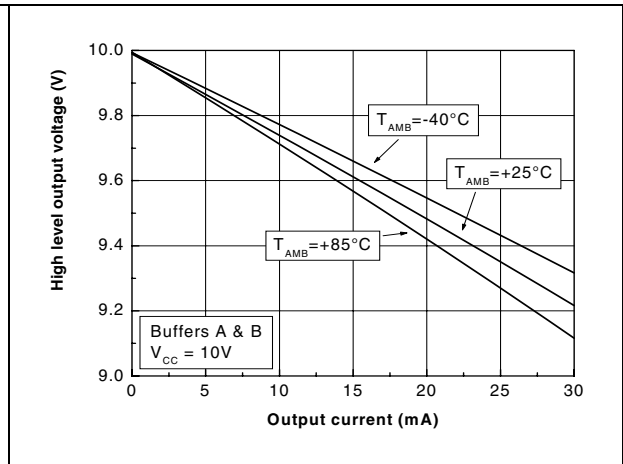

Figure 14. Voltage output high ( $V_{OH}$ ) vs. output current - Buffers A & B

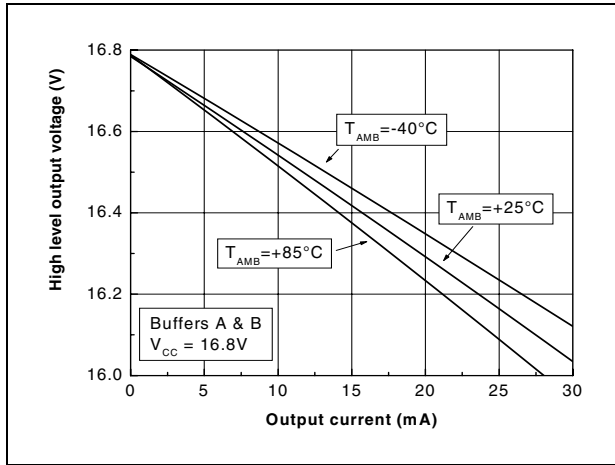

Figure 15. Voltage output low ( $V_{OL}$ ) vs. output current - Buffers C to L

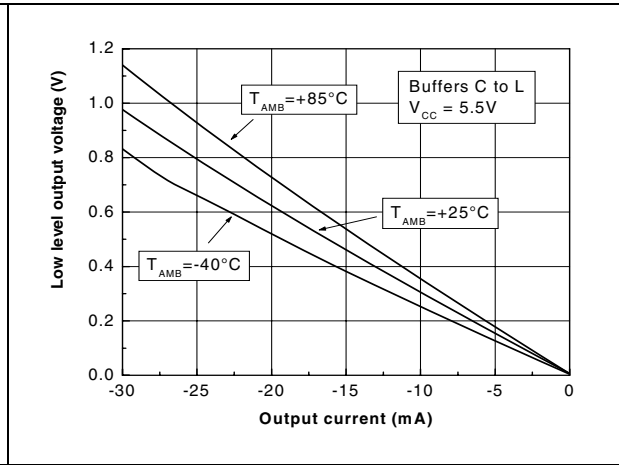

Figure 16. Voltage output low ( $V_{OL}$ ) vs. output current - Buffers C to L

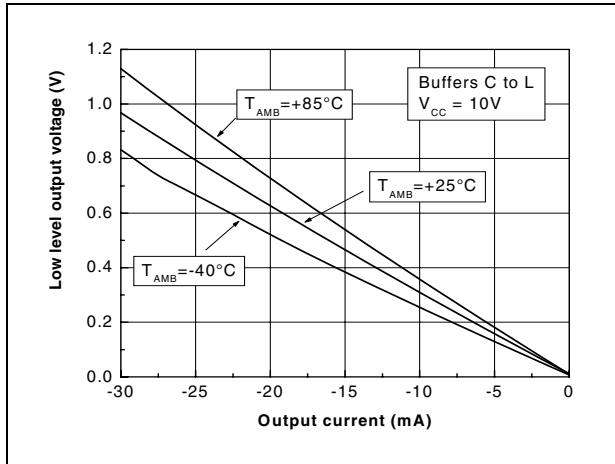

Figure 17. Voltage output low ( $V_{OL}$ ) vs. output current - Buffers C to L

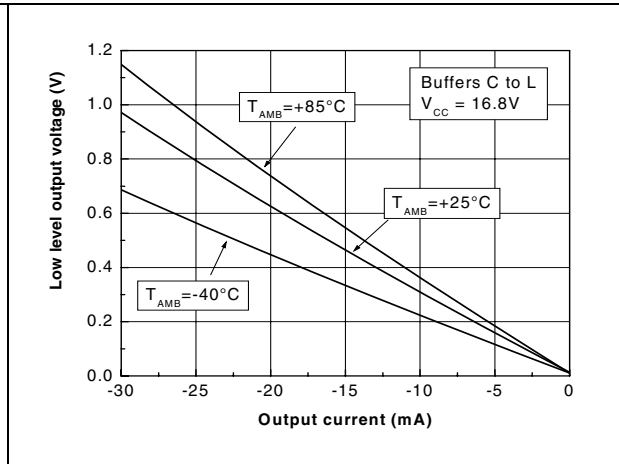

Figure 18. Voltage output low ( $V_{OL}$ ) vs. output current - Buffers M, N & COM

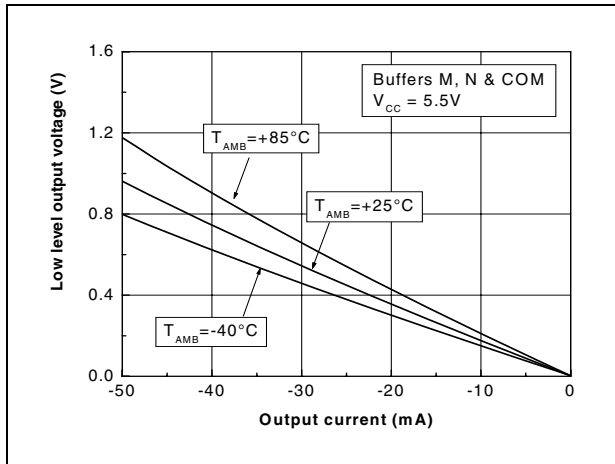

Figure 19. Voltage output low ( $V_{OL}$ ) vs. output current - Buffers M, N & COM

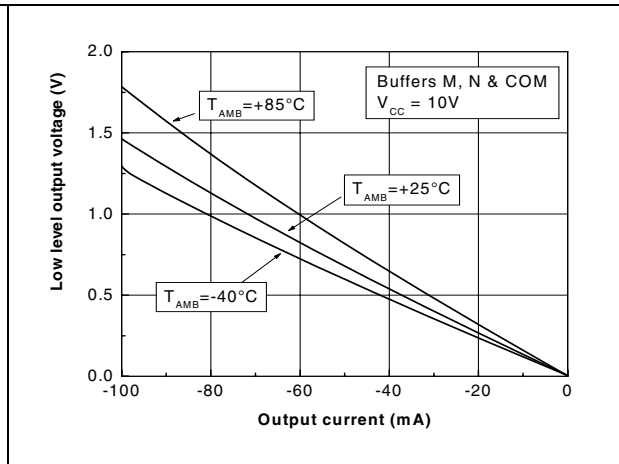



Figure 20. Voltage output low ( $V_{OL}$ ) vs. output current - Buffers M, N & COM

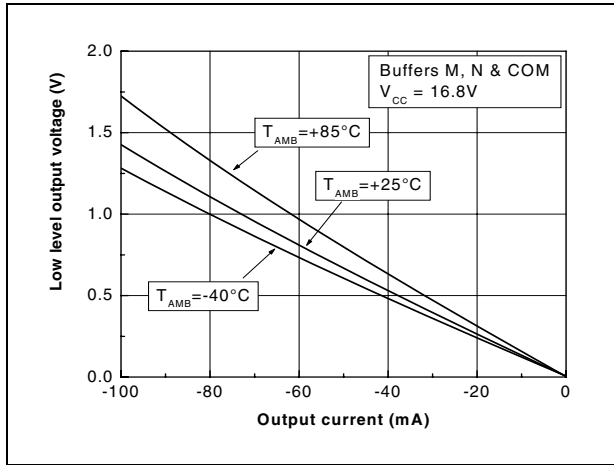

Figure 21. Positive slew rate vs. temperature

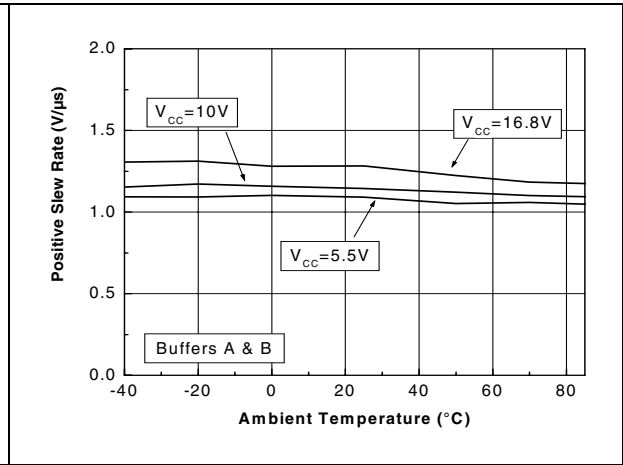

Figure 22. Positive slew rate vs. temperature

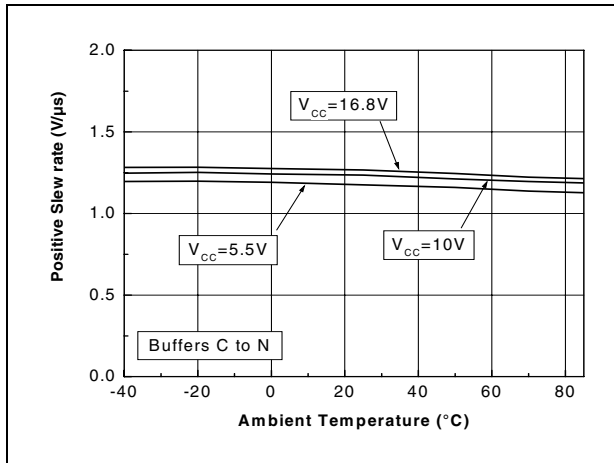

Figure 23. Positive slew rate vs. temperature

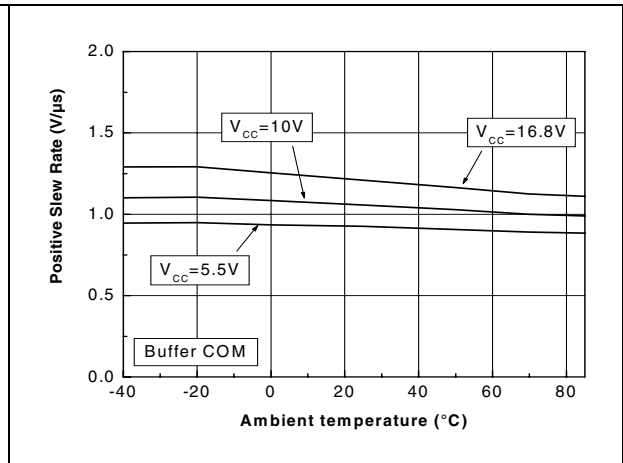

Figure 24. Negative slew rate vs. temperature

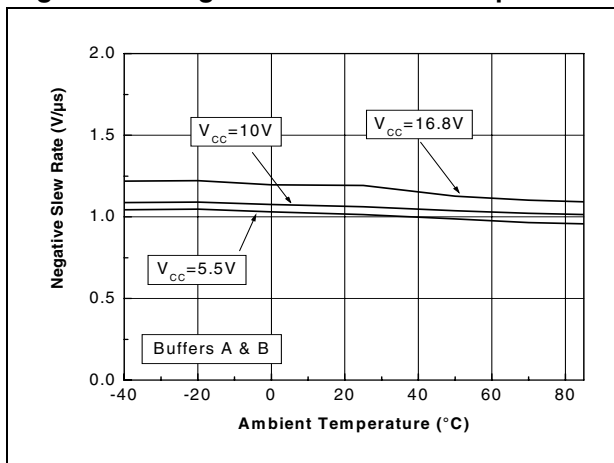

Figure 25. Negative slew rate vs. temperature

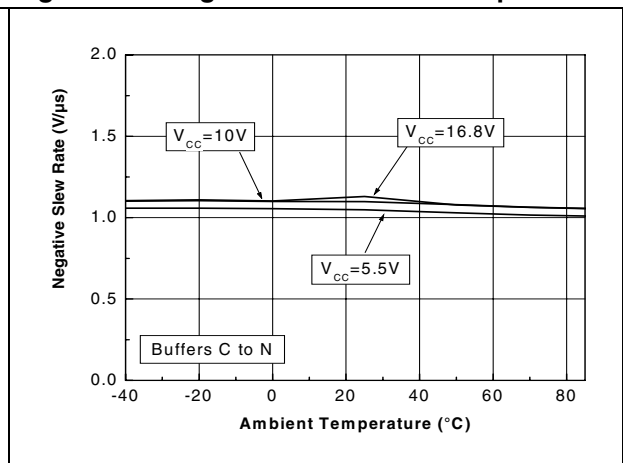

Figure 26. Negative slew rate vs. temperature

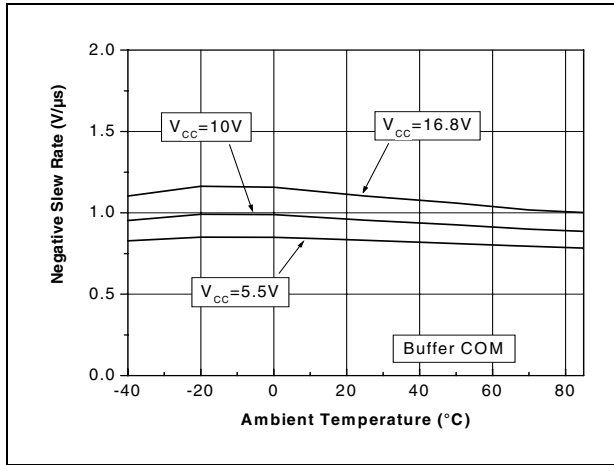

Figure 27. Large signal response - buffers A & B

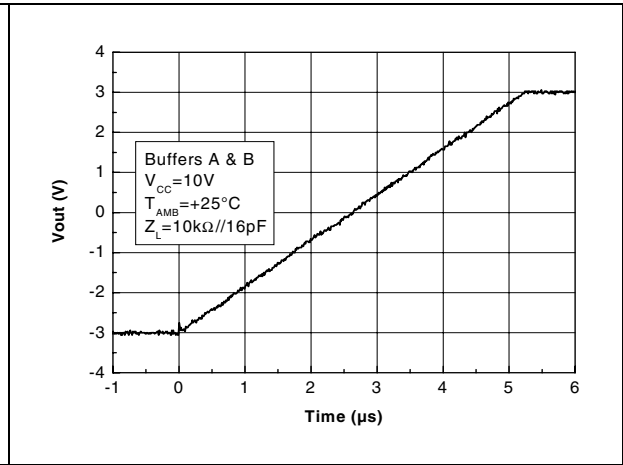

Figure 28. Large signal response - buffers A & B

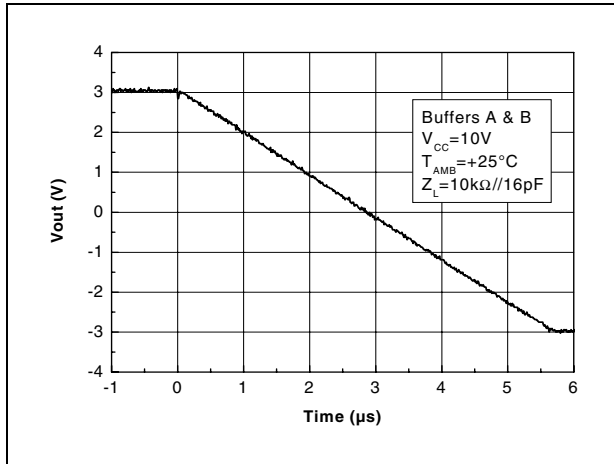

Figure 29. Large signal response - buffers C to N

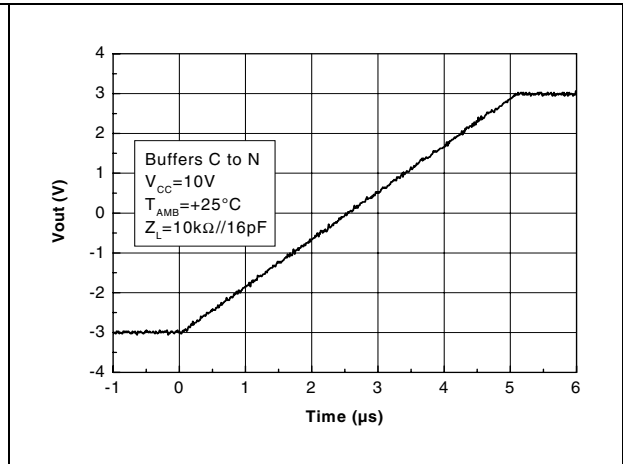

Figure 30. Large signal response - buffers C to N

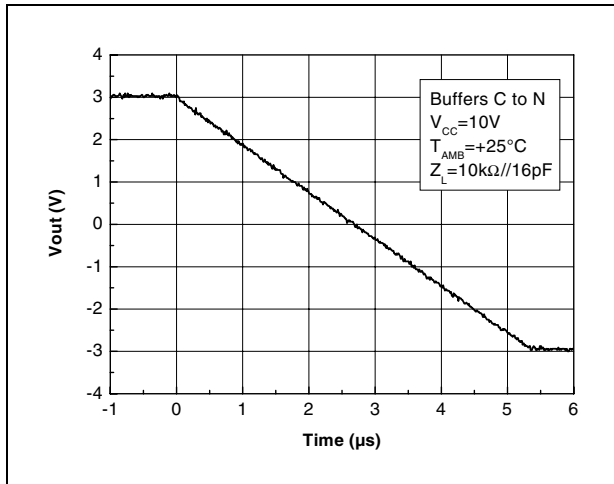

Figure 31. Large signal response - buffer COM

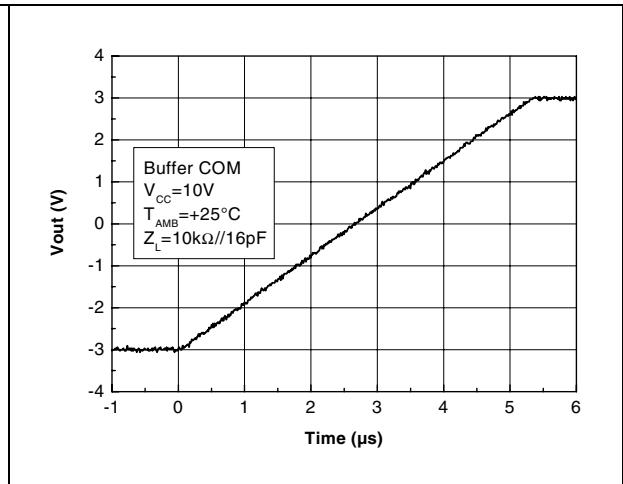

Figure 32. Large signal response - buffer COM

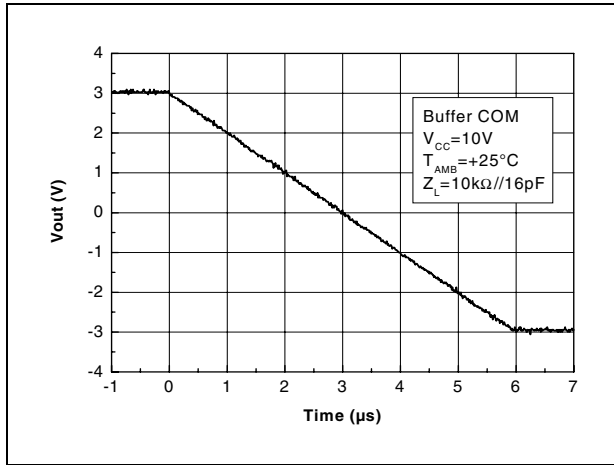

Figure 33. Small signal response - buffers A & B

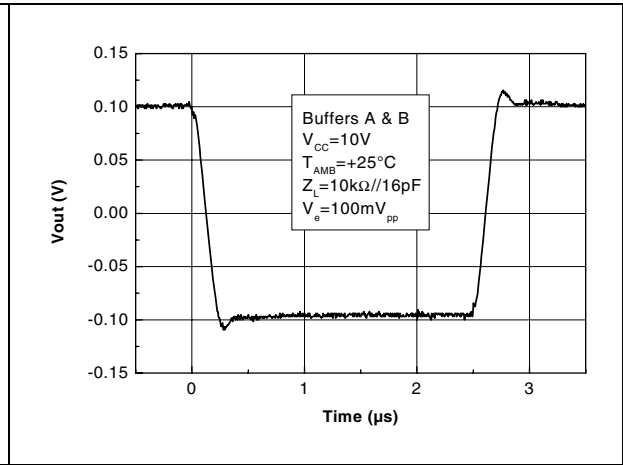

Figure 34. Small signal response - buffers C to N

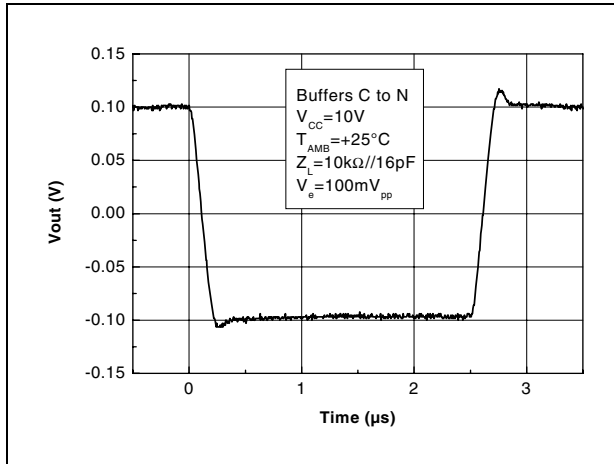

Figure 35. Small signal response - buffer COM

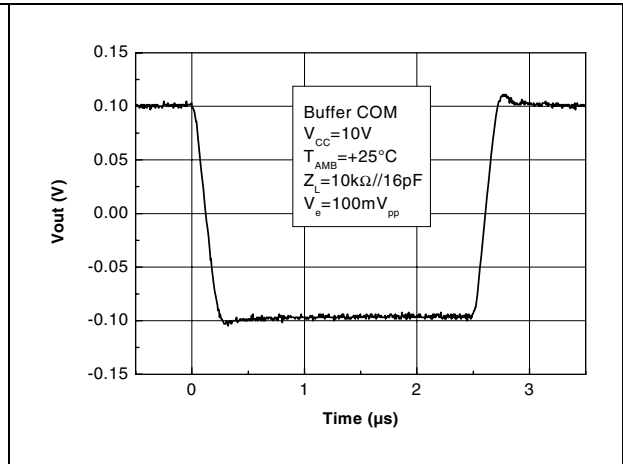

Figure 36. Output voltage response to current transient - buffers A & B

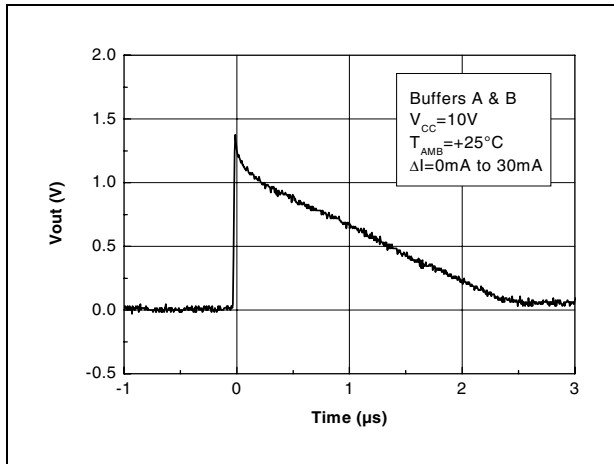

Figure 37. Output voltage response to current transient - buffers A & B

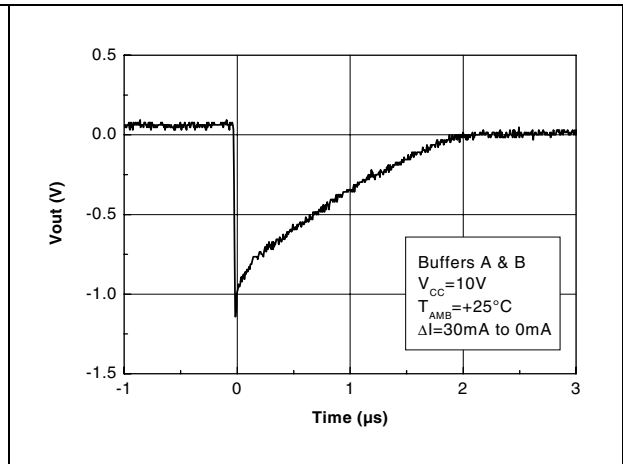

Figure 38. Output voltage response to current transient - buffers C to N

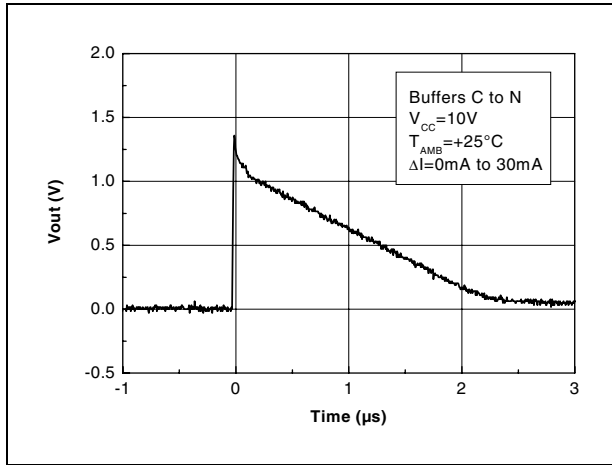

Figure 39. Output voltage response to current transient - buffers C to N

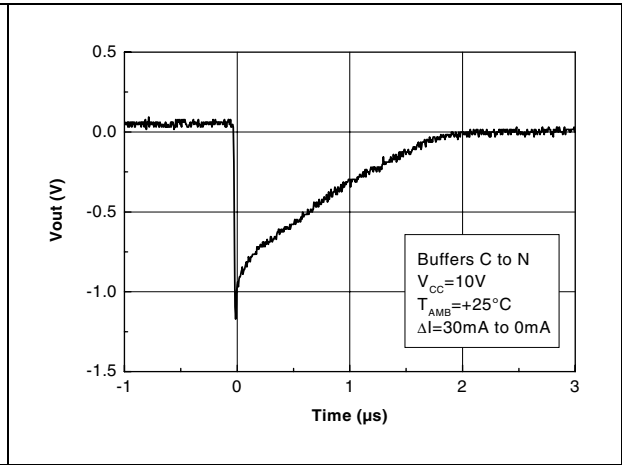

Figure 40. Output voltage response to current transient - buffer COM

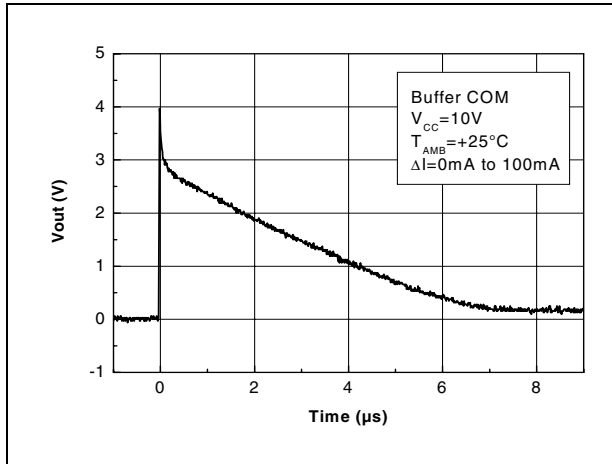

Figure 41. Output voltage response to current transient - buffer COM

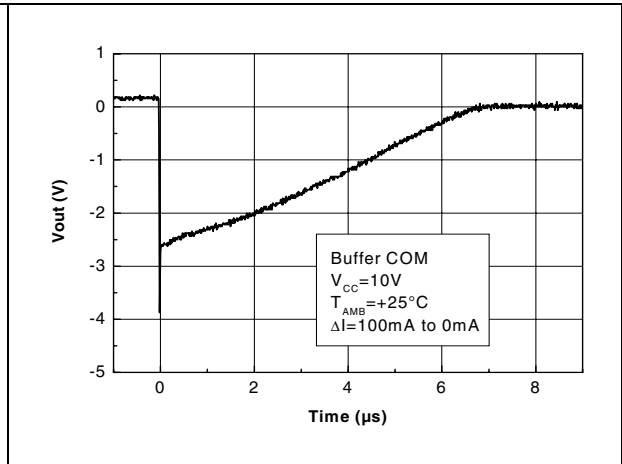

Figure 42. Output voltage response to current transient - buffer COM

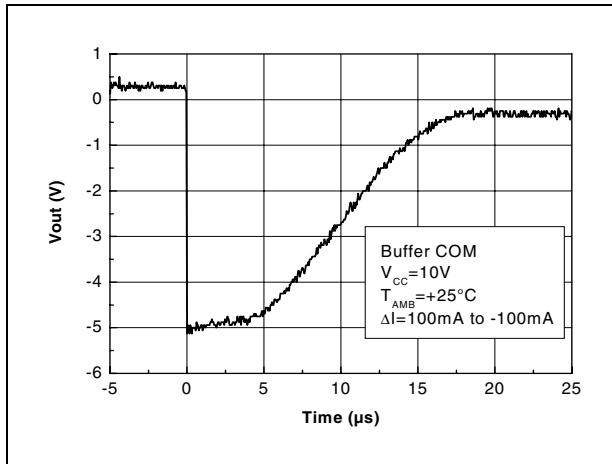
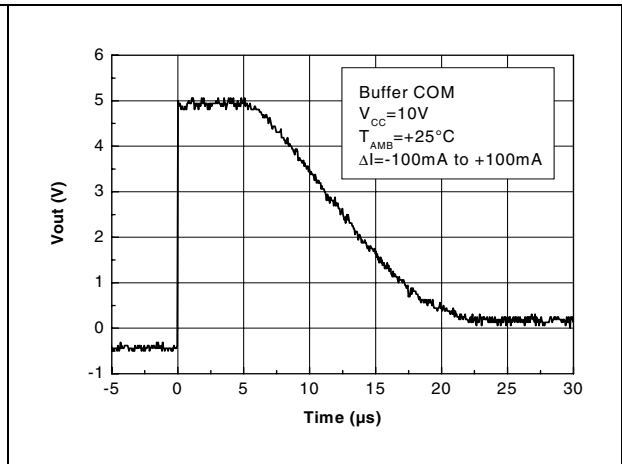

Figure 43. Output voltage response to current transient - buffer COM



## 4 Package information

In order to meet environmental requirements, STMicroelectronics offers these devices in ECOPACK<sup>®</sup> packages. These packages have a lead-free second level interconnect. The category of second level interconnect is marked on the package and on the inner box label, in compliance with JEDEC Standard JESD97. The maximum ratings related to soldering conditions are also marked on the inner box label. ECOPACK is an STMicroelectronics trademark. ECOPACK specifications are available at: [www.st.com](http://www.st.com).

Table 5. TQFP48 package mechanical data

Ref.	Dimensions					
	Millimeters			Inches		
	Min.	Typ.	Max.	Min.	Typ.	Max.
A			1.6			0.063
A1	0.05		0.15	0.002		0.006
A2	1.35	1.40	1.45	0.053	0.055	0.057
B	0.17	0.22	0.27	0.007	0.009	0.011
C	0.09		0.20	0.0035		0.0079
D		9.00			0.354	
D1		7.00			0.276	
D3		5.50			0.216	
e		0.50			0.020	
E		9.00			0.354	
E1		7.00			0.276	
E3		5.50			0.216	
L	0.45	0.60	0.75	0.018	0.024	0.030
L1		1.00			0.039	
K	0°	3.5°	7°	0°	3.5°	7°

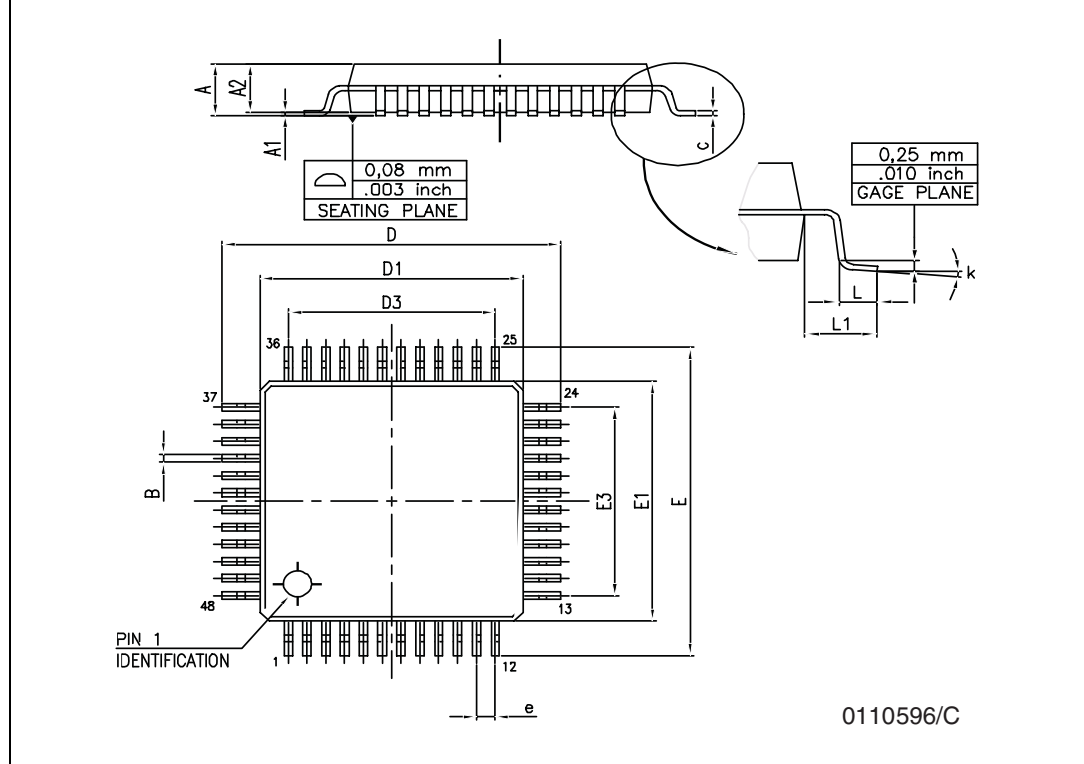

## 5 Ordering information

**Table 6. Order codes**

Order code	Temperature range	Package	Packing	Marking
TSL1014IF	-40°C to +85°C	TQFP48	Tray	SL1014I
TSL1014IFT			Tape & reel	
TSL1014IYF <sup>(1)</sup>			Tray	SL1014Y
TSL1014IYFT <sup>(1)</sup>			Tape & reel	

1. Qualification and characterization according to AEC Q100 and Q003 or equivalent, advanced screening according to AEC Q001 & Q 002 or equivalent are on-going.

## 6 Revision history

**Table 7. Document revision history**

Date	Revision	Changes
01-Jul-2005	1	Initial release - Product in full production.
01-Sep-2005	2	Lead temperature corrected in <a href="#">Table 1 on page 2</a> . Electrical characteristics graphs re-ordered from <a href="#">Figure 2 on page 6</a> to <a href="#">Figure 43 on page 12</a> .
07-Mar-2007	3	Notes added on ESD in <a href="#">Table 1 on page 2</a> . Maximum operating supply voltage increased in <a href="#">Table 2 on page 2</a> . Input voltage parameters added in <a href="#">Table 2 on page 2</a> . $V_{OL}$ limits changed for Buffers C to L in <a href="#">Table 4 on page 5</a> .
09-Jun-2008	4	Electrical characteristics table added for automotive parts. Order codes added for automotive parts.
19-Aug-2008	5	Modified $I_{CC}$ typical and maximum values for standard parts in <a href="#">Table 3</a> . Updated all curves ( <a href="#">Figure 2</a> to <a href="#">Figure 43</a> ). Added ESD charged device model value in <a href="#">Figure 1</a> .

**Please Read Carefully:**

Information in this document is provided solely in connection with ST products. STMicroelectronics NV and its subsidiaries ("ST") reserve the right to make changes, corrections, modifications or improvements, to this document, and the products and services described herein at any time, without notice.

All ST products are sold pursuant to ST's terms and conditions of sale.

Purchasers are solely responsible for the choice, selection and use of the ST products and services described herein, and ST assumes no liability whatsoever relating to the choice, selection or use of the ST products and services described herein.

No license, express or implied, by estoppel or otherwise, to any intellectual property rights is granted under this document. If any part of this document refers to any third party products or services it shall not be deemed a license grant by ST for the use of such third party products or services, or any intellectual property contained therein or considered as a warranty covering the use in any manner whatsoever of such third party products or services or any intellectual property contained therein.

**UNLESS OTHERWISE SET FORTH IN ST'S TERMS AND CONDITIONS OF SALE ST DISCLAIMS ANY EXPRESS OR IMPLIED WARRANTY WITH RESPECT TO THE USE AND/OR SALE OF ST PRODUCTS INCLUDING WITHOUT LIMITATION IMPLIED WARRANTIES OF MERCHANTABILITY, FITNESS FOR A PARTICULAR PURPOSE (AND THEIR EQUIVALENTS UNDER THE LAWS OF ANY JURISDICTION), OR INFRINGEMENT OF ANY PATENT, COPYRIGHT OR OTHER INTELLECTUAL PROPERTY RIGHT.**

**UNLESS EXPRESSLY APPROVED IN WRITING BY AN AUTHORIZED ST REPRESENTATIVE, ST PRODUCTS ARE NOT RECOMMENDED, AUTHORIZED OR WARRANTED FOR USE IN MILITARY, AIR CRAFT, SPACE, LIFE SAVING, OR LIFE SUSTAINING APPLICATIONS, NOR IN PRODUCTS OR SYSTEMS WHERE FAILURE OR MALFUNCTION MAY RESULT IN PERSONAL INJURY, DEATH, OR SEVERE PROPERTY OR ENVIRONMENTAL DAMAGE. ST PRODUCTS WHICH ARE NOT SPECIFIED AS "AUTOMOTIVE GRADE" MAY ONLY BE USED IN AUTOMOTIVE APPLICATIONS AT USER'S OWN RISK.**

Resale of ST products with provisions different from the statements and/or technical features set forth in this document shall immediately void any warranty granted by ST for the ST product or service described herein and shall not create or extend in any manner whatsoever, any liability of ST.

ST and the ST logo are trademarks or registered trademarks of ST in various countries.

Information in this document supersedes and replaces all information previously supplied.

The ST logo is a registered trademark of STMicroelectronics. All other names are the property of their respective owners.

© 2008 STMicroelectronics - All rights reserved

STMicroelectronics group of companies

Australia - Belgium - Brazil - Canada - China - Czech Republic - Finland - France - Germany - Hong Kong - India - Israel - Italy - Japan - Malaysia - Malta - Morocco - Singapore - Spain - Sweden - Switzerland - United Kingdom - United States of America

[www.st.com](http://www.st.com)