

### SOT-26



**Pin Definition:**  
 1. Drain 6. Drain  
 2. Drain 5, Drain  
 3. Gate 4. Source

### PRODUCT SUMMARY

$V_{DS}$ (V)	$R_{DS(on)}$ (m $\Omega$ )	$I_D$ (A)
30	30 @ $V_{GS} = 10V$	6.7
	42 @ $V_{GS} = 4.5V$	5.7

### Features

- Advance Trench Process Technology
- High Density Cell Design for Ultra Low On-resistance

### Application

- Load Switch
- PA Switch

### Ordering Information

Part No.	Package	Packing
TSM3424CX6 RF	SOT-26	3Kpcs / 7" Reel

### Block Diagram

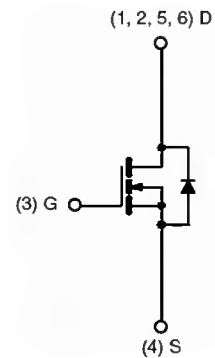

N-Channel MOSFET

### Absolute Maximum Rating (Ta = 25°C unless otherwise noted)

Parameter	Symbol	Limit	Unit
Drain-Source Voltage	$V_{DS}$	30	V
Gate-Source Voltage	$V_{GS}$	$\pm 20$	V
Continuous Drain Current	$I_D$	6.7	A
Pulsed Drain Current	$I_{DM}$	30	A
Continuous Source Current (Diode Conduction) <sup>a,b</sup>	$I_S$	1.7	A
Maximum Power Dissipation	$P_D$	Ta = 25°C	2.0
		Ta = 75°C	1.3
Operating Junction Temperature	$T_J$	+150	°C
Operating Junction and Storage Temperature Range	$T_J, T_{STG}$	-55 to +150	°C

### Thermal Performance

Parameter	Symbol	Limit	Unit
Junction to Case Thermal Resistance	$R_{\theta JC}$	30	°C/W
Junction to Ambient Thermal Resistance (PCB mounted)	$R_{\theta JA}$	80	°C/W

#### Notes:

- Pulse width limited by the Maximum junction temperature
- Surface Mounted on FR4 Board,  $t \leq 10$  sec.

### Electrical Specifications (Ta = 25°C unless otherwise noted)

Parameter	Conditions	Symbol	Min	Typ	Max	Unit
<b>Static</b>						
Drain-Source Breakdown Voltage	$V_{GS} = 0V, I_D = 250\mu A$	$BV_{DSS}$	30	--	--	V
Gate Threshold Voltage	$V_{DS} = V_{GS}, I_D = 250\mu A$	$V_{GS(TH)}$	1	1.4	3	V
Gate Body Leakage	$V_{GS} = \pm 20V, V_{DS} = 0V$	$I_{GSS}$	--	--	$\pm 100$	$\mu A$
Zero Gate Voltage Drain Current	$V_{DS} = 24V, V_{GS} = 0V$	$I_{DSS}$	--	--	1.0	$\mu A$
On-State Drain Current	$V_{DS} \geq 5V, V_{GS} = 10V$	$I_{D(ON)}$	30	--	--	A
Drain-Source On-State Resistance	$V_{GS} = 10V, I_D = 6.7A$	$R_{DS(ON)}$	--	23	30	m $\Omega$
	$V_{GS} = 4.5V, I_D = 5.7A$		--	32	42	
Forward Transconductance	$V_{DS} = 5V, I_D = 5.0A$	$g_{fs}$	--	14	--	S
Diode Forward Voltage	$I_S = 1.7A, V_{GS} = 0V$	$V_{SD}$	--	0.76	1	V
<b>Dynamic<sup>b</sup></b>						
Total Gate Charge	$V_{DS} = 15V, I_D = 6.7A, V_{GS} = 10V$	$Q_g$	--	4.52	--	nC
Gate-Source Charge		$Q_{gs}$	--	1.24	--	
Gate-Drain Charge		$Q_{gd}$	--	1.68	--	
Input Capacitance	$V_{DS} = 15V, V_{GS} = 0V, f = 1.0MHz$	$C_{iss}$	--	400.96	--	pF
Output Capacitance		$C_{oss}$	--	100.47	--	
Reverse Transfer Capacitance		$C_{rss}$	--	71.82	--	
<b>Switching<sup>c</sup></b>						
Turn-On Delay Time	$V_{DD} = 15V, R_L = 2.2\Omega, I_D = 1A, V_{GEN} = 10V, R_G = 6\Omega$	$t_{d(on)}$	--	7.42	--	nS
Turn-On Rise Time		$t_r$	--	3.41	--	
Turn-Off Delay Time		$t_{d(off)}$	--	20.4	--	
Turn-Off Fall Time		$t_f$	--	3.01	--	

**Notes:**

- a. pulse test: PW  $\leq 300\mu s$ , duty cycle  $\leq 2\%$
- b. For DESIGN AID ONLY, not subject to production testing.
- b. Switching time is essentially independent of operating temperature.

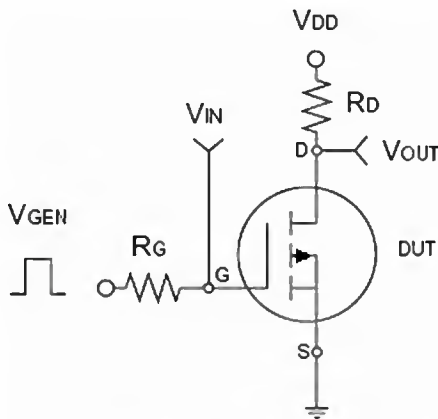

**Switching Test Circuit**

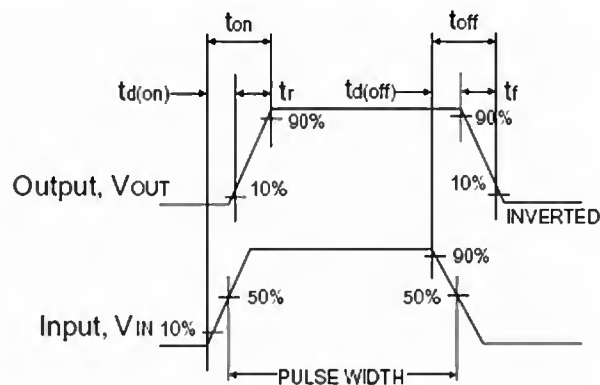

**Switchin Waveforms**

**Electrical Characteristics Curve** (Ta = 25°C, unless otherwise noted)

**Output Characteristics**

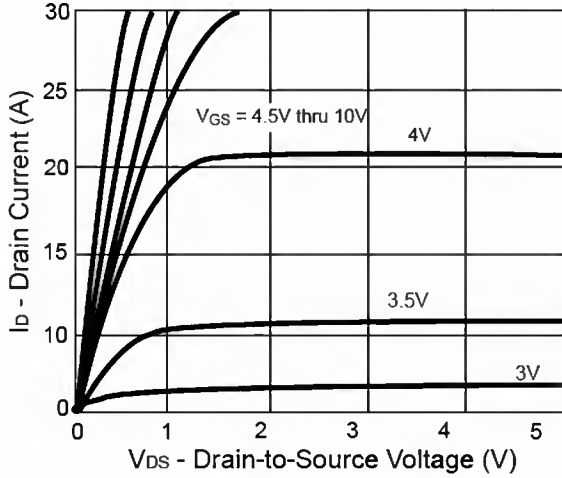

**Transfer Characteristics**

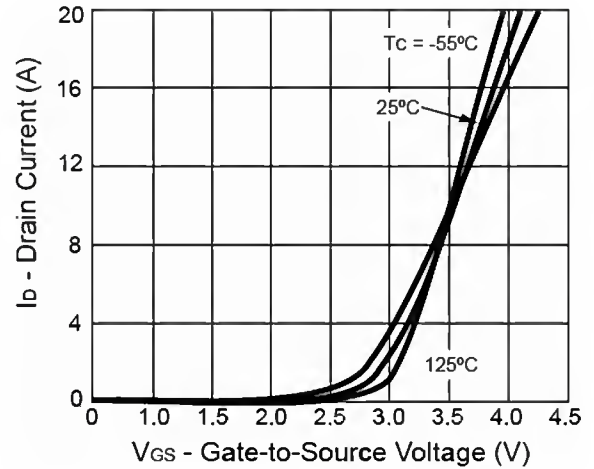

**On-Resistance vs. Drain Current**

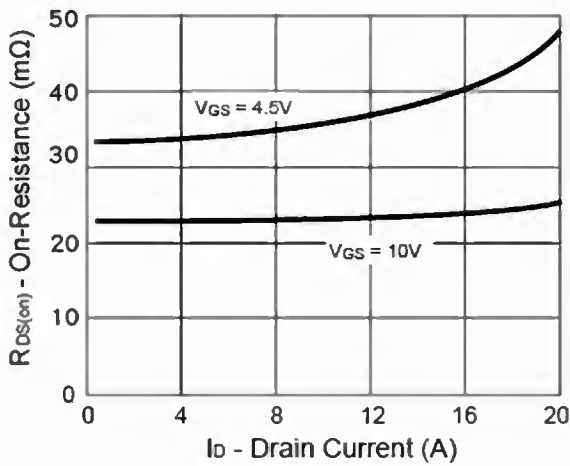

**Gate Charge**

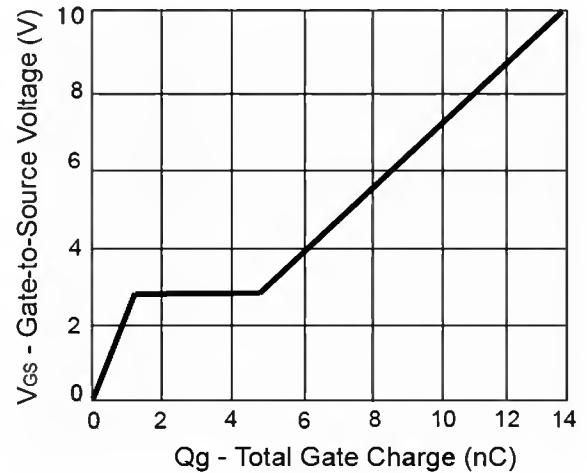

**On-Resistance vs. Junction Temperature**

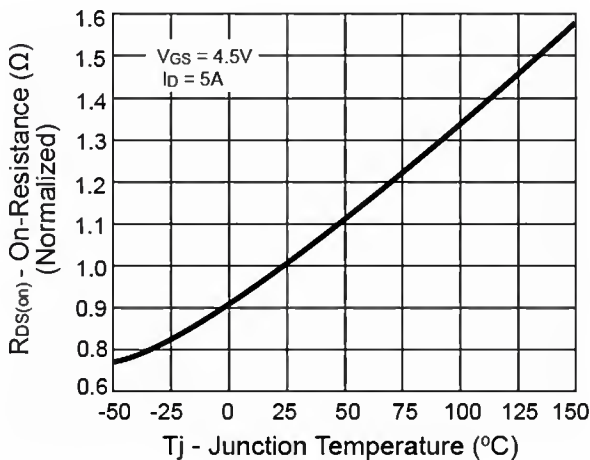

**Source-Drain Diode Forward Voltage**

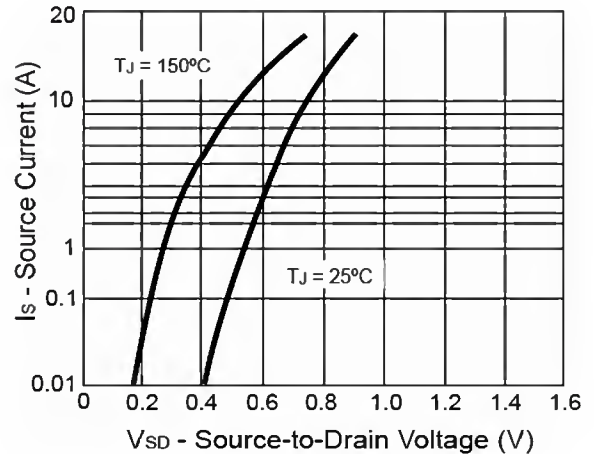

**Electrical Characteristics Curve** (Ta = 25°C, unless otherwise noted)

**On-Resistance vs. Gate-Source Voltage**

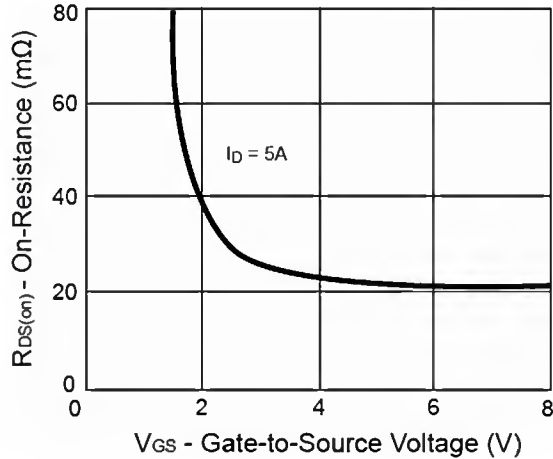

**Threshold Voltage**

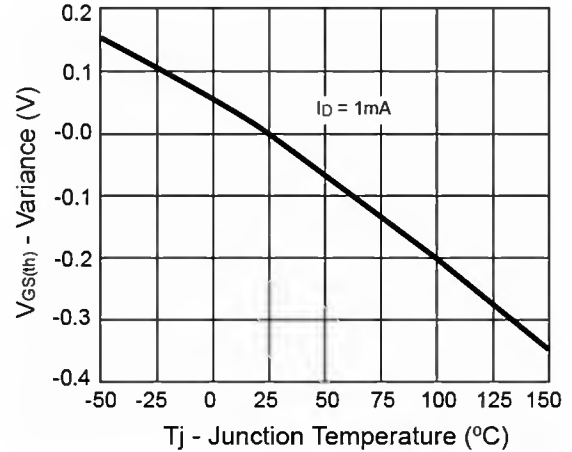

**Single Pulse Power**

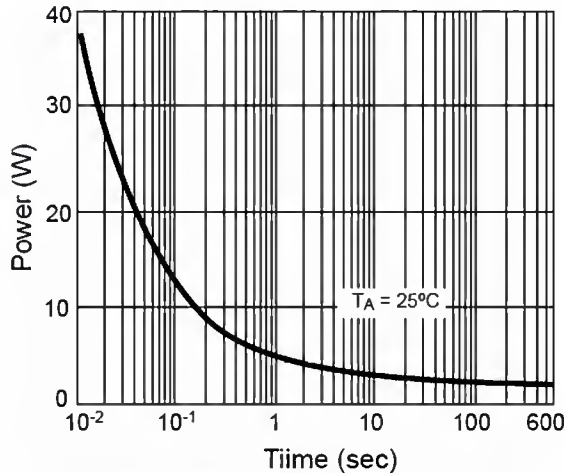

**Normalized Thermal Transient Impedance, Junction-to-Ambient**

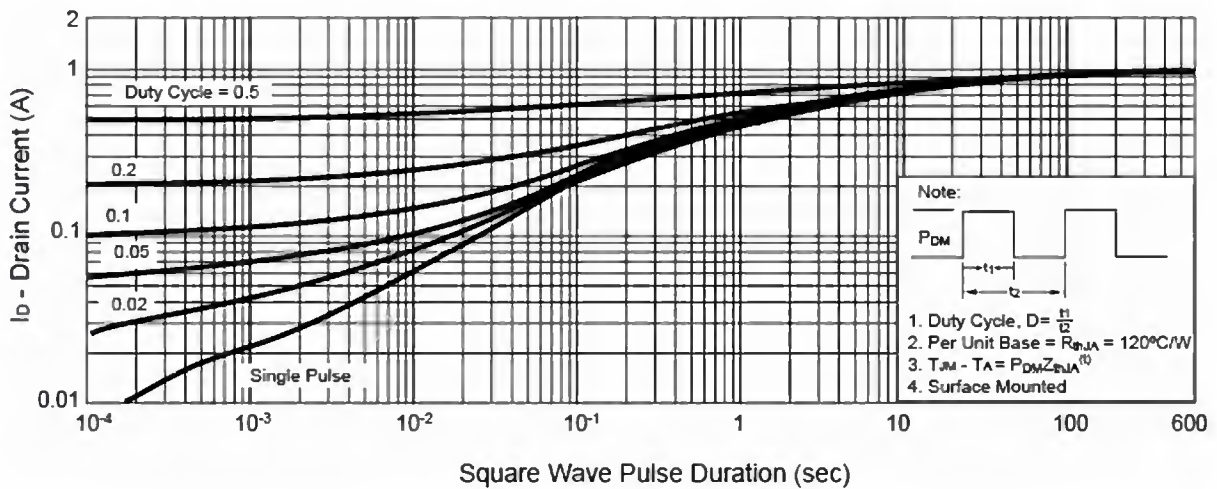

**SOT-26 Mechanical Drawing**

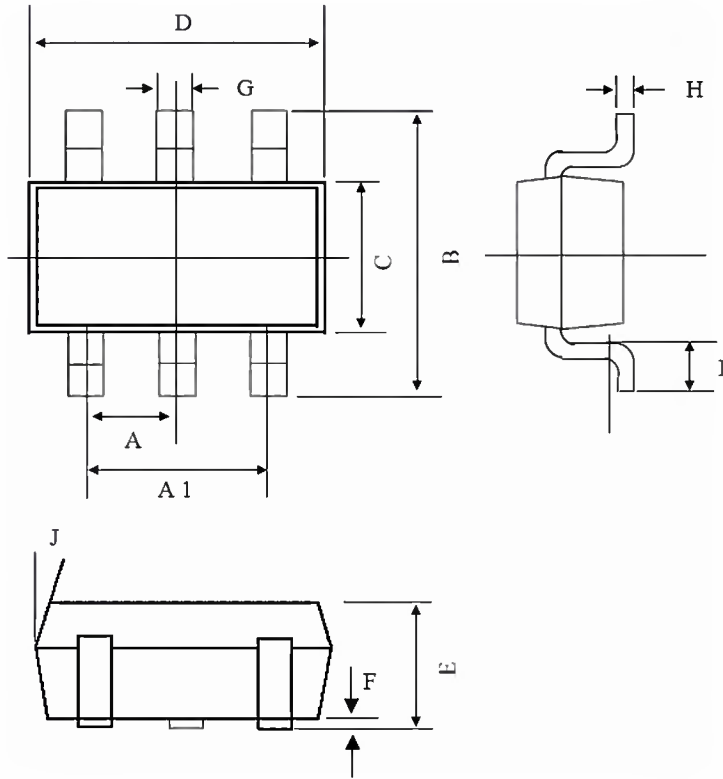

SOT-26 DIMENSION						
DIM	MILLIMETERS			INCHES		
	MIN	TYP	MAX	MIN	TYP	MAX
A	0.95 BSC			0.0374 BSC		
A1	1.9 BSC			0.0748 BSC		
B	2.60	2.80	3.00	0.1024	0.1102	0.1181
C	1.40	1.50	1.70	0.0551	0.0591	0.0669
D	2.80	2.90	3.10	0.1101	0.1142	0.1220
E	1.00	1.10	1.20	0.0394	0.0433	0.0472
F	0.00	--	0.10	0.00		0.0039
G	0.35	0.40	0.50	0.0138	0.0157	0.0197
H	0.10	0.15	0.20	0.0039	0.0059	0.0079
I	0.30	--	0.60	0.0118	--	0.0236
J	5°	--	10°	5°	--	10°

**Marking Diagram**

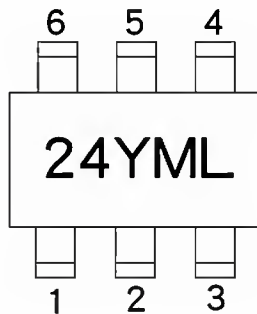

- 24** = Device Code
- Y** = Year Code
- M** = Month Code  
(A=Jan, B=Feb, C=Mar, D=Apl, E=May, F=Jun, G=Jul, H=Aug, I=Sep, J=Oct, K=Nov, L=Dec)
- L** = Lot Code

## Notice

Specifications of the products displayed herein are subject to change without notice. TSC or anyone on its behalf, assumes no responsibility or liability for any errors or inaccuracies.

Information contained herein is intended to provide a product description only. No license, express or implied, to any intellectual property rights is granted by this document. Except as provided in TSC's terms and conditions of sale for such products, TSC assumes no liability whatsoever, and disclaims any express or implied warranty, relating to sale and/or use of TSC products including liability or warranties relating to fitness for a particular purpose, merchantability, or infringement of any patent, copyright, or other intellectual property right.

The products shown herein are not designed for use in medical, life-saving, or life-sustaining applications. Customers using or selling these products for use in such applications do so at their own risk and agree to fully indemnify TSC for any damages resulting from such improper use or sale.