

HIGH VOLTAGE SURFACE MOUNT SWITCHING DIODE

LMBD3004SLT1G

FEATURE

- Fast Switching Speed
- High Conductance
- High Reverse Breakdown Voltage Rating
- We declare that the material of product compliance with RoHS requirements.

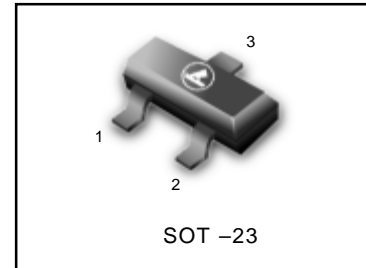

Ordering Information(Pb-free)

Device	Marking	Shipping
LMBD3004SLT1G	KAE	3000/Tape&Reel
LMBD3004SLT3G	KAE	10000/Tape&Reel

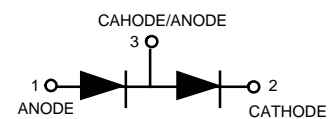

Maximum Ratings @ T_A=25°C unless otherwise specified

Characteristic	Symbol	LMC10114L	Unit
Repetitive Peak Reverse Voltage	VRRM	350	V
Working Peak Reverse Voltage	VRWM	300	V
DC Blocking Voltage	VR		
RMS Reverse Voltage	VR(RMS)	212	V
Forward Continuous Current(Note 2)	I _F	225	mA
Peak Repetitive Forward Current(Note 2)	I _{FRM}	625	mA
Non-Repetitive Peak Forward Surge Current @t=1.0μs	I _{FSM}	4.0	A
@t=1.0s		1.0	
Power Dissipation(Note 2)	P _d	350	mW
Thermal Resistance Junction to Ambient Air(Note 2)	R _{θJA}	357	°C/W
Operating and Storage Temperature Range	T _j , T _{STG}	-65 to +150	°C

Electrical Characteristics @ T_A=25°C unless otherwise specified, per element

Characteristic	Symbol	Min	Typ	MAX	Unit	Test Condition
Reverse Breakdown Voltage(Note 1)	V _{(BR)R}	350			V	I _R =100μA
Forward Voltage(Note 1)	V _F		0.78	0.87	V	I _F =20mA
			0.93	1.0		I _F =100mA
			1.03	1.25		I _F =200mA
Reverse Current(Note 1)	I _R		30	100	nA	V _R =240V
			35	100		μA
Total Capacitance	C _T		1.0	5.0	Pf	V _R =0V, f=1.0MHZ
Reverse Recovery Time	T _{rr}			50	ns	I _F =I _R =30mA I _{rr} =3.0mA, R _L =100Ω

- Notes: 1. Short duration test pulse used to minimize self-heating effect.
2. Part mounted on FR-4 board with recommended pad layout.

LMBD3004SLT1G

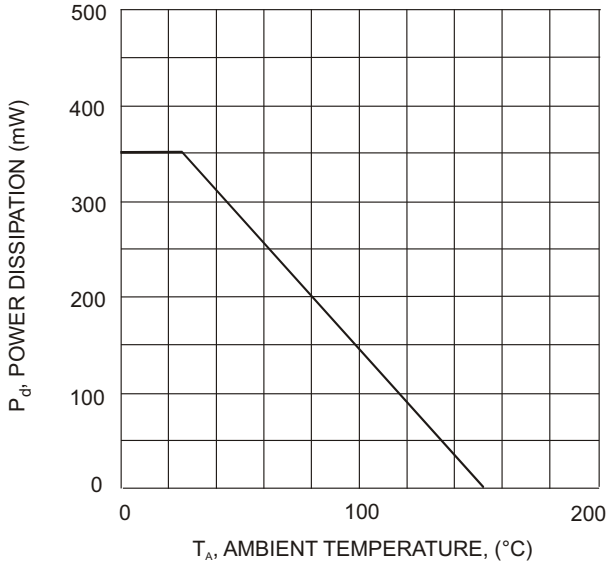

T_A, AMBIENT TEMPERATURE, (°C)
Fig. 1 Power Derating Curve, total package

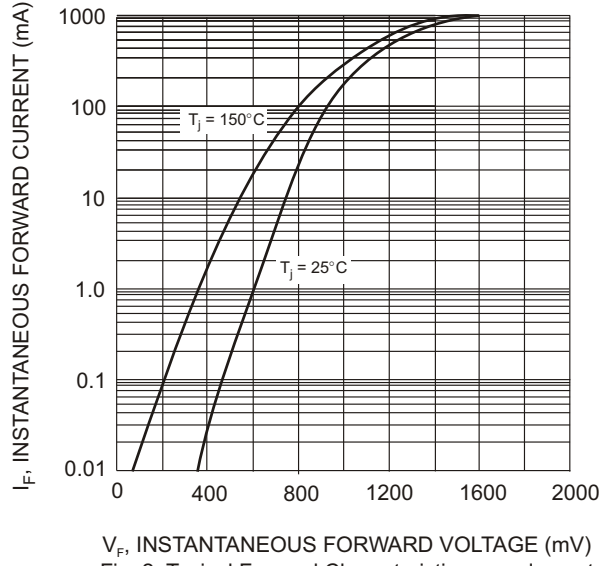

V_F, INSTANTANEOUS FORWARD VOLTAGE (mV)
Fig. 2 Typical Forward Characteristics, per element

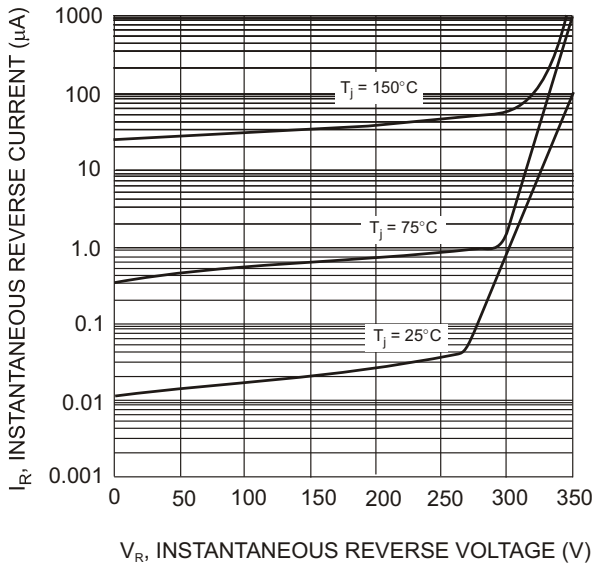

V_R, INSTANTANEOUS REVERSE VOLTAGE (V)
Fig. 3 Typical Reverse Characteristics, per element

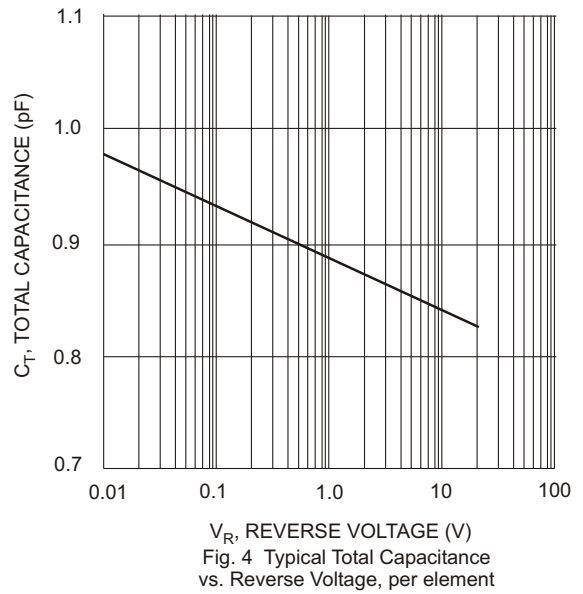

V_R, REVERSE VOLTAGE (V)
Fig. 4 Typical Total Capacitance vs. Reverse Voltage, per element

LMBD3004SLT1G

SOT-23

NOTES:

1. DIMENSIONING AND TOLERANCING PER ANSI Y14.5M,1982
2. CONTROLLING DIMENSION: INCH.

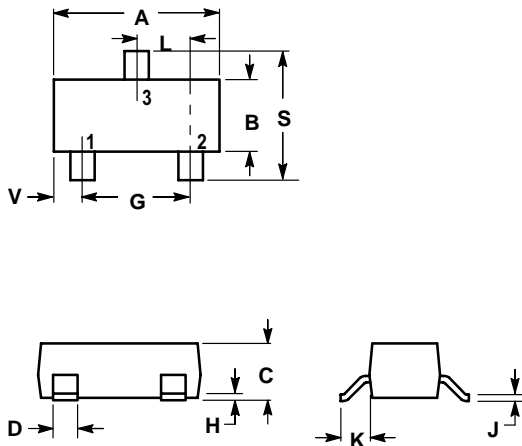

DIM	INCHES		MILLIMETERS	
	MIN	MAX	MIN	MAX
A	0.1102	0.1197	2.80	3.04
B	0.0472	0.0551	1.20	1.40
C	0.0350	0.0440	0.89	1.11
D	0.0150	0.0200	0.37	0.50
G	0.0701	0.0807	1.78	2.04
H	0.0005	0.0040	0.013	0.100
J	0.0034	0.0070	0.085	0.177
K	0.0140	0.0285	0.35	0.69
L	0.0350	0.0401	0.89	1.02
S	0.0830	0.1039	2.10	2.64
V	0.0177	0.0236	0.45	0.60

- PIN 1. BASE
- 2. EMITTER
- 3. COLLECTOR

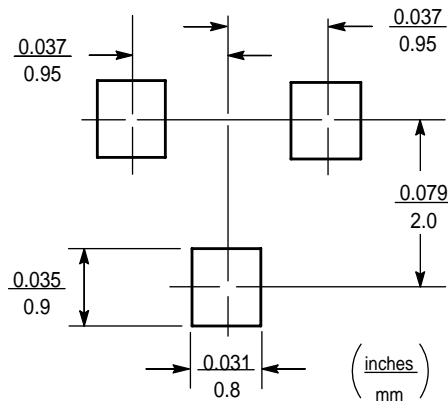

EMBOSSED TAPE AND REEL DATA FOR DISCRETES

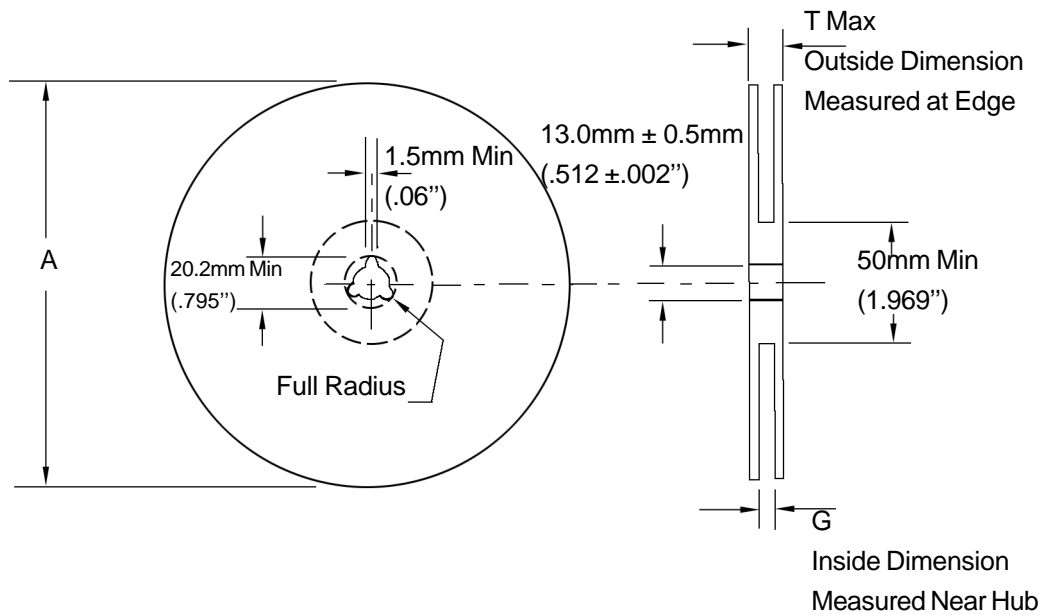

Size	A Max	G	T Max
8 mm	330mm (12.992")	8.4mm+1.5mm, -0.0 (.33"+.059", -0.00)	14.4mm (.56")

Reel Dimensions

Metric Dimensions Govern — English are in parentheses for reference only

Storage Conditions

Temperature: 5 to 40 Deg.C (20 to 30 Deg. C is preferred)

Humidity: 30 to 80 RH (40 to 60 is preferred)

Recommended Period: One year after manufacturing

(This recommended period is for the soldering condition only. The characteristics and reliabilities of the products are not restricted to this limitation)

Shipment Specification

