

BRIGHT LED ELECTRONICS CORP.

LED LAMPS SPECIFICATION

●COMMODITY : Standard 1.0"Lead 4 ϕ

PAGE: 2

●DEVICE NUMBER : BL-B5432

VERSION : 1.0

●ELECTRICAL AND OPTICAL CHARACTERISTICS (Ta=25°C)

Chip		Lens Appearance	Absolute Maximum Rating				Electro-optical Data (At 20mA)			Viewing Angle 2 θ 1/2 (deg)
Emitted Color	Peak Wave Length λP (nm)		$\Delta \lambda$ (nm)	Pd (mW)	If (mA)	Peak If(mA)	Vf(V)		Iv Typ. (mcd)	
							Typ.	Max.		
Bright Red	700	Red Trans	90	40	15	50	2.2	2.6	24.0	35

Remark : Viewing angle is the Off-axis angle at which the luminous intensity is half the axial luminous intensity.

●ABSOLUTE MAXIMUM RATINGS (Ta=25°C)

Reverse Voltage	5V
Reverse Current (V _R =5V)	100 μ A
Operating Temperature Range	-40°C ~ 80°C
Storage Temperature Range	-40°C ~ 85°C
Lead Soldering Temperature	260°C For 5 Seconds

●PACKAGE DIMENSIONS

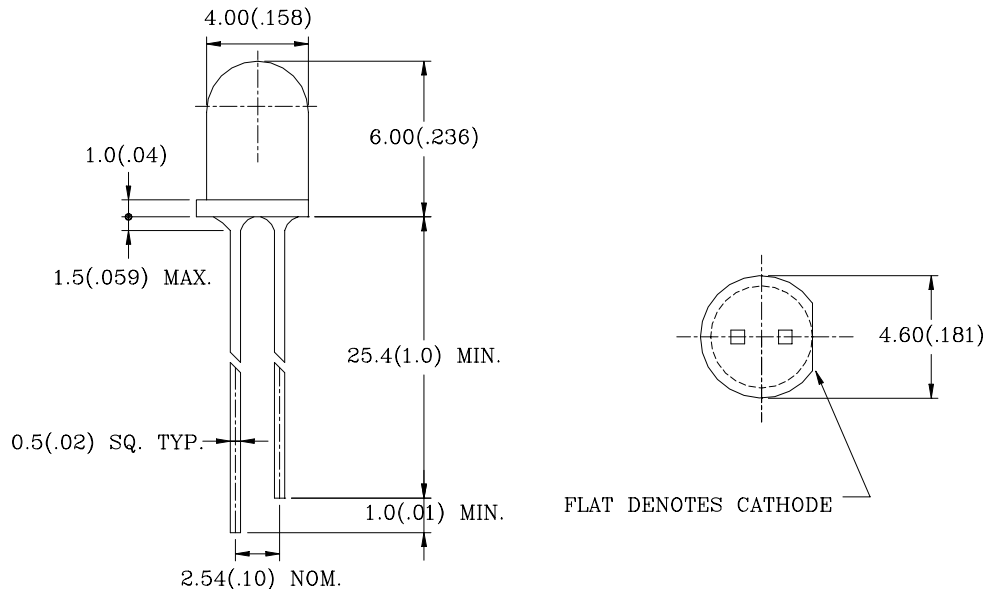

NOTES: 1.All dimensions are in millimeters (inches).

2.Tolerance is ± 0.25 mm (0.01") unless otherwise specified.

3.Lead spacing is measured where the leads emerge from the package.

4.Specifications are subject to change without notice.

BRIGHT LED ELECTRONICS CORP.

LED LAMPS SPECIFICATION

- COMMODITY : Standard 1.0"Lead 4 ϕ
- DEVICE NUMBER : BL-B5432
- ELECTRICAL AND OPTICAL CHARACTERISTICS (Ta=25°C)

PAGE: 3
VERSION : 1.0

SPECTRAL DISTRIBUTION

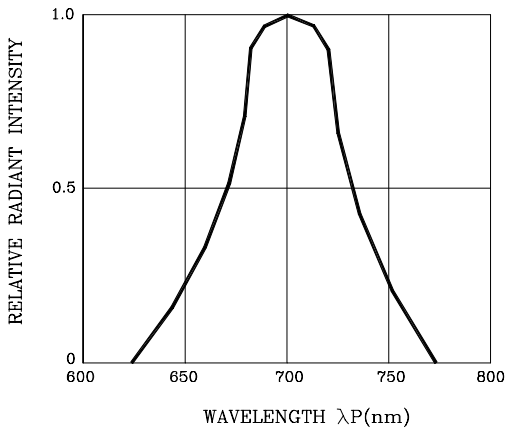

FORWARD CURRENT DERATING CURVE

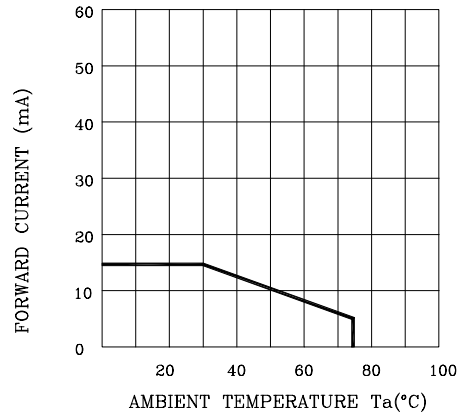

FORWARD CURRENT VS. FORWARD VOLTAGE

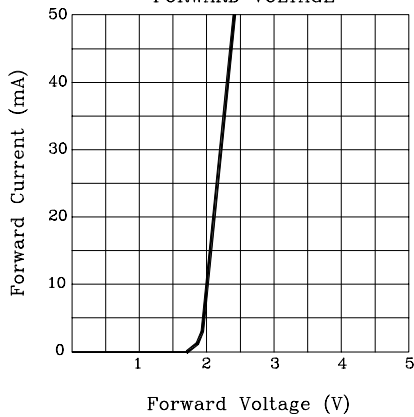

RELATIVE RADIANT INTENSITY VS. AMBIENT TEMPERATURE

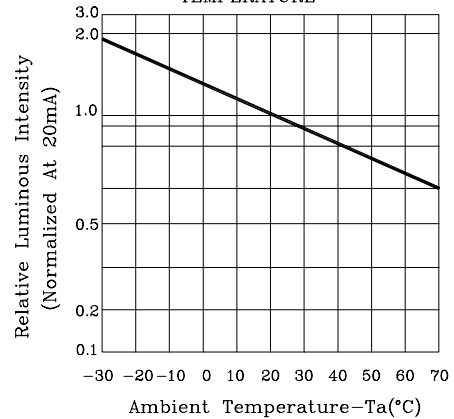

RELATIVE RADIANT INTENSITY VS. FORWARD CURRENT

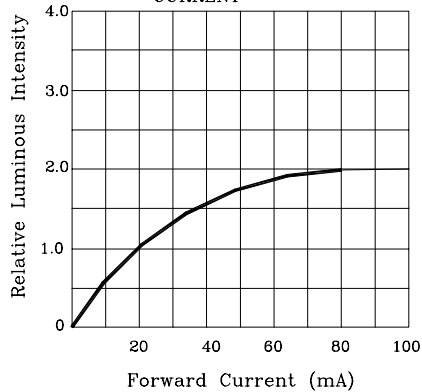

RADIATION DIAGRAM

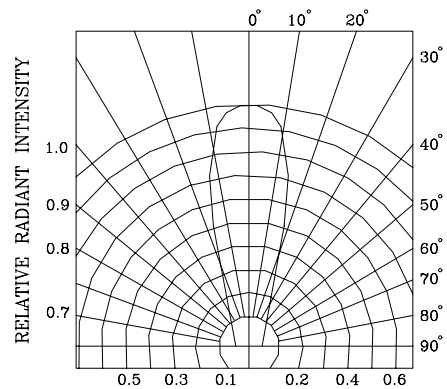

BRIGHT LED ELECTRONICS CORP.

LED LAMPS SPECIFICATION

RELIABILITY TEST

PAGE: 4
VERSION : 1.0

Classification	Test Item	Reference Standard	Test Conditions	Result
Endurance Test	Operation Life	MIL-STD-750:1026 MIL-STD-883:1005 JIS C 7021 :B-1	Connect with a power $I_f=20\text{mA}$ T_a =Under room temperature Test time=1,000hrs	0/100
	High Temperature High Humidity Storage	MIL-STD-202:103B JIS C 7021 :B-11	$T_a=85^\circ\text{C}\pm 5^\circ\text{C}$ RH=90%-95% Test time=240hrs	0/100
	High Temperature Storage	MIL-STD-883:1008 JIS C 7021 :B-10	High $T_a=105^\circ\text{C}\pm 5^\circ\text{C}$ Test time=1,000hrs	0/100
	Low Temperature Storage	JIS-C-7021 :B-12	Low $T_a=-55^\circ\text{C}\pm 5^\circ\text{C}$ Test time=1,000hrs	0/100
Environmental Test	Temperature Cycling	MIL-STD-202:107D MIL-STD-750:1051 MIL-STD-883:1010 JIS C 7021 :A-4	$-55^\circ\text{C} \sim 25^\circ\text{C} \sim 105^\circ\text{C} \sim 25^\circ\text{C}$ 30min 5min 30min 5min Test Time=10cycle	0/100
	Thermal Shock	MIL-STD-202:107D MIL-STD-750:1051 MIL-STD-883:1011	$-55^\circ\text{C}\pm 5^\circ\text{C} \sim 105^\circ\text{C}\pm 5^\circ\text{C}$ 10min 10min Test Time=10cycle	0/100
	Solder Resistance	MIL-STD-202:201A MIL-STD-750:2031 JIS C 7021 :A-1	$T_{\text{sol}}=260\pm 5^\circ\text{C}$ Dwell Time= $5\pm 1\text{sec.}$	0/50
	Solder ability	MIL-STD-202:208D MIL-STD-750:2026 MIL-STD-883:2003 JIS C 7021 :A-2	$T_{\text{sol}}=230\pm 5^\circ\text{C}$ Dwell Time= $5\pm 1\text{sec.}$	0/50
	Lead Bending Stress	MIL-STD-750:2036 JIS C 7021 :A-11	$0^\circ\sim 90^\circ\sim 0^\circ\text{bend}$, 3 cycles Weight 250g	0/50

JUDGMENT CRITERIA OF FAILURE FOR THE RELIABILITY

Measuring items	Symbol	Measuring conditions	Judgement criteria for failure
Forward voltage	V_F	$I_f=20\text{mA}$	Over $U_x1.2$
Reverse current	I_r	$V_r=5\text{V}$	Over U_x2
Luminous intensity	I_v	$I_f=20\text{mA}$	Below $S_x0.5$

Note: 1.U means the upper limit of specified characteristics. S means initial value.

2.Measurment shall be taken between 2 hours and after the test pieces have been returned to normal ambient conditions after completion of each test.

BRIGHT LED ELECTRONICS CORP.

PACKAGING DIMMENSIONS

PAGE: 5
VERSION : 1.0

PACKAGING BOX DIMENSIONS:

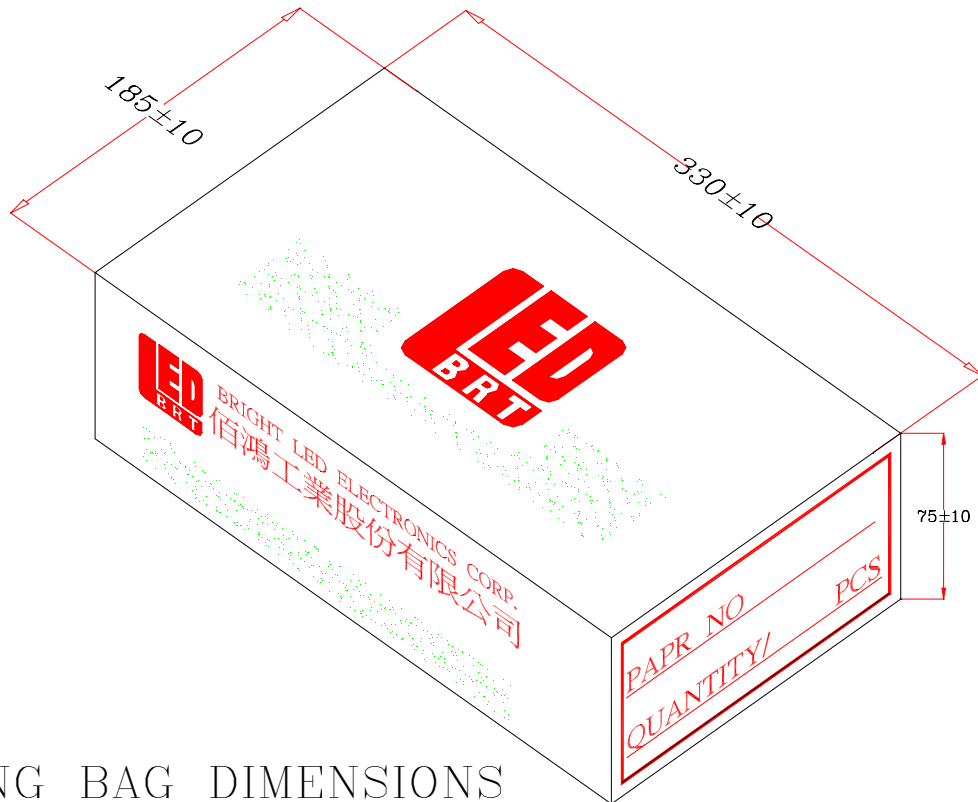

PACKAGING BAG DIMENSIONS

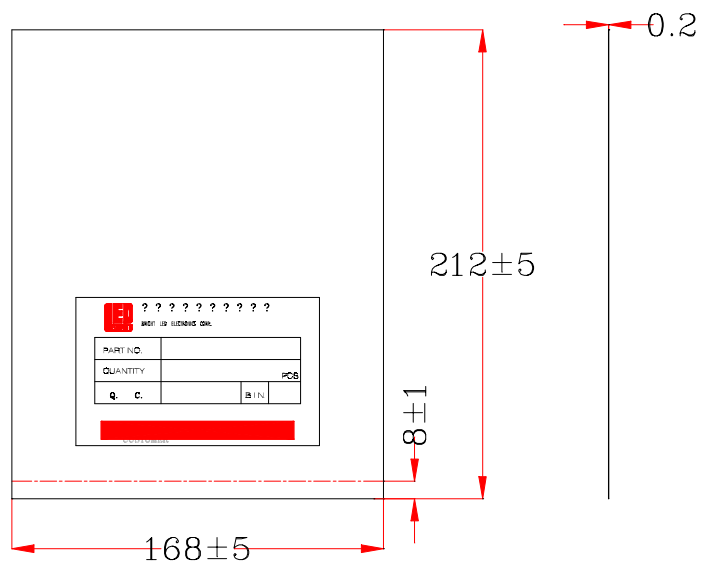

NOTES:

- 1.1000PCS PER BAG, 10K PCS PER BOX
- 2.ALL Dimensions are in millimeters (inches).
- 3.Specifications are subject to change without notice.