

**PLEASE CHECK WWW.MOLEX.COM FOR LATEST PART INFORMATION**

**Part Number:** [0546987001](#)  
**Status:** **Active**  
**Description:** 0.80mm (.031") Pitch S.O. DIMM Socket, Right Angle, Surface Mount, 5.20mm (.205") Mounted Height, 144 Circuits, 5.0V Power Supply, Lead-free

**Documents:**

[3D Model](#) [Product Specification PS-54698-003 \(PDF\)](#)  
[Drawing \(PDF\)](#) [RoHS Certificate of Compliance \(PDF\)](#)

**General**

Product Family	Memory Module Sockets
Series	<a href="#">54698</a>
Comments	5.0V Power Supply
Component Type	Memory Module
JEDEC Outline	N/A
Product Name	S.O. DIMM

**Physical**

Circuits (Loaded)	144
Color - Resin	Natural
Durability (mating cycles max)	30
Entry Angle	90° Angle (Side Entry)
Keying to Mating Part	Yes
Material - Metal	Brass, Phosphor Bronze
Material - Plating Mating	Gold
Material - Plating Termination	Tin
Material - Resin	High Temperature Thermoplastic
PCB Retention	Yes
PCB Thickness Recommended (in)	0.045 In
PCB Thickness Recommended (mm)	1.20 mm
Packaging Type	Tray
Pitch - Mating Interface (in)	0.031 In
Pitch - Mating Interface (mm)	0.80 mm
Plating min: Mating (µin)	10
Plating min: Mating (µm)	0.25
Plating min: Termination (µin)	40
Plating min: Termination (µm)	1
Temperature Range - Operating	-55°C to +85°C
Termination Interface: Style	Surface Mount

**Electrical**

Current - Maximum per Contact	0.3A
Voltage - Maximum	100V
Voltage Key	5.0V

**Material Info**

**Reference - Drawing Numbers**

Product Specification	PS-54698-003
Sales Drawing	SD-54698-004

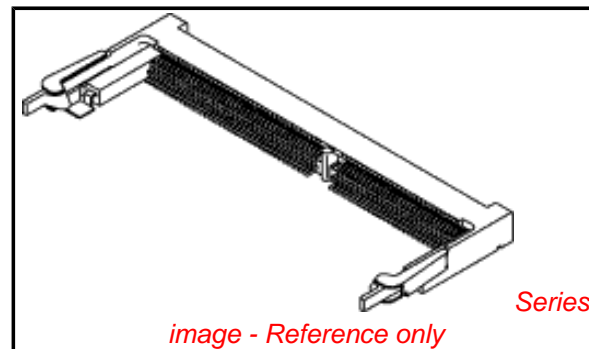

*image - Reference only*

**EU RoHS**

**ELV and RoHS  
Compliant**

**REACH SVHC**

Not Reviewed

**Halogen-Free**

Status

**Not Reviewed**

**China RoHS**



**Need more information on product  
environmental compliance?**

Email [productcompliance@molex.com](mailto:productcompliance@molex.com)  
 For a multiple part number RoHS Certificate of Compliance, [click here](#)

Please visit the [Contact Us](#) section for any non-product compliance questions.

**Search Parts in this Series**

[54698Series](#)

**Mates With**

JEDEC Standard DRAM and SDRAM modules

DWG. NO. SD-54698-004

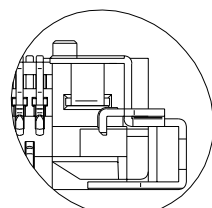
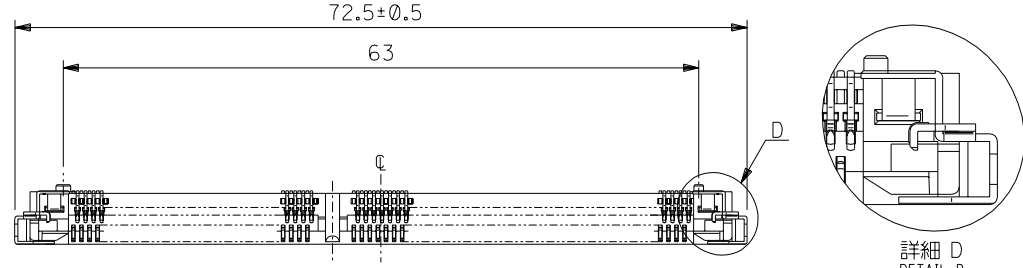

詳細 D  
DETAIL D  
(SCALE 5:1)

注記  
NOTES

- 材料  
MATERIAL  
ハウジング : ガラス入り耐熱樹脂、白色、UL94V-0  
ターミナル : 燐青銅  
TERMINAL : PHOSPHOR BRONZE  
ネイル : 黄銅  
NAIL : BRASS
- めっき仕様  
PLATING  
ロングターミナル  
LONG TERMINAL  
接点部 : 金めっき 0.25μmMIN.  
CONTACT AREA : GOLD 0.25 MICROMETER MINIMUM.  
半田付け部 : 錫めっき 1.0μmMIN.  
SOLDER TAIL AREA : TIN 1.0 MICROMETER MINIMUM.  
下地めっき : ニッケルめっき 2.0μmMIN.  
UNDER-PLATING : NICKEL 2.0 MICROMETER MINIMUM.  
ショートターミナル  
SHORT TERMINAL  
接点部 : 金めっき 0.25μmMIN.  
CONTACT AREA : GOLD 0.25 MICROMETER MINIMUM.  
半田付け部 : 錫めっき 1.0μmMIN.  
SOLDER TAIL AREA : TIN 1.0 MICROMETER MINIMUM.  
下地めっき : ニッケルめっき 2.0μmMIN.  
UNDER-PLATING : NICKEL 2.0 MICROMETER MINIMUM.  
ネイル  
NAIL  
錫めっき : 1.0μmMIN.  
TIN : 1.0 MICROMETER MINIMUM.  
下地めっき : ニッケルめっき 1.0μmMIN.  
UNDER-PLATING : NICKEL 1.0 MICROMETER MINIMUM.
- テール平坦度は、0.1 MAX.とする。  
TAIL COPLANARITY TO BE 0.1 MAX.  
ネイル平坦度は、0.1 MAX.とする。  
NAIL COPLANARITY TO BE 0.1 MAX.
- 本製品は54698-144\*の鉛フリー品である。  
THIS PRODUCT IS LEAD FREE OF 54698-144\*.

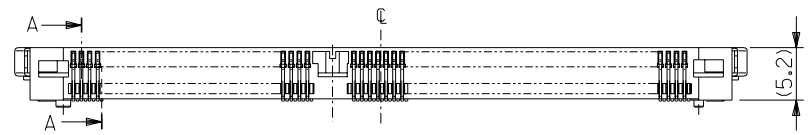
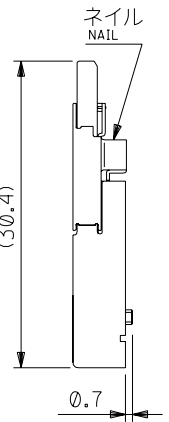
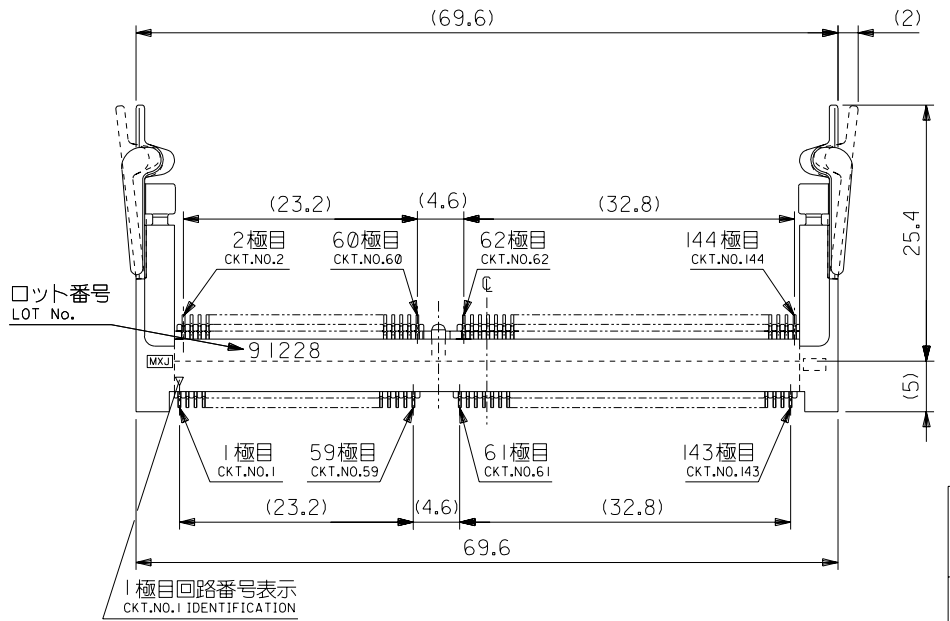

1.75	2.85	1.35	3.25	4.05	***V	ハードトレイ(高さ9)	54698-7008	54698-700*
						ハードトレイ(高さ11)	54698-7005	
						標準トレイ	54698-7002	
3.25	1.35	2.85	1.75	5.55	5.0V	ハードトレイ(高さ9)	54698-7007	
						ハードトレイ(高さ11)	54698-7004	
						標準トレイ	54698-7001	
2.5	2.1	2.1	2.5	4.8	3.3V	ハードトレイ(高さ9)	54698-7006	
						ハードトレイ(高さ11)	54698-7003	
						標準トレイ	54698-7000	
E	D	C	B	A	POWER SUPPLY	梱包トレイ	MATERIAL NO.	

DO NOT SCALE DRAWING

EC NO. DRWN: CH'K: APPR:	EC NO. DRWN: CH'K: APPR:	EC NO. DRWN: CH'K: APPR:	EC NO. DRWN: CH'K: APPR:	EC NO. DRWN: CH'K: APPR:	<p>RELEASED EC NO. J2004-4231 04/05/14</p> <p>DRWN: M.NAGATA 04/05/14</p> <p>CH'K: K.TOJO 04/05/14</p> <p>APPR: M.SASAO 04/05/14</p>	<p>MATERIAL 材料</p> <p>注記参照 SEE NOTES</p> <p>FINISH 仕上げ</p> <p>注記参照 SEE NOTES</p> <p>WIRE RANGE 適用電線範囲</p> <p>INS. RANGE 被覆外径</p>	<p>GENERAL TOLERANCES: (UNLESS SPECIFIED) 一般公差</p> <p>10 UNDER 未満 ±0.2</p> <p>10 OVER 30 UNDER 未満 ±0.25</p> <p>30 OVER 以上 ±0.3</p> <p>ANGLE 角度 ±3°</p>	<p>SCALE 2:1</p> <p>DESIGN UNITS <input checked="" type="checkbox"/>mm <input type="checkbox"/>INCH</p> <p>THIRD ANGLE PROJECTION</p> <p>TITLE: 0.8mm PITCH S.O.DIMM SOCKET 144CKT. HEIGHT 5.2mm -LEAD FREE-</p> <p>MOLEX MOLEX INCORPORATED</p>	<p>SHT REV</p> <p>REVISE ON CAD ONLY</p> <p>CAD FILENAME SD-54698-004.S01</p> <p>MATERIAL NO. SEE CHART</p> <p>DRAWING NO. SD-54698-004</p> <p>SHEET NO. 1 OF 3</p>
-----------------------------	-----------------------------	-----------------------------	-----------------------------	-----------------------------	--	--	--	--	---

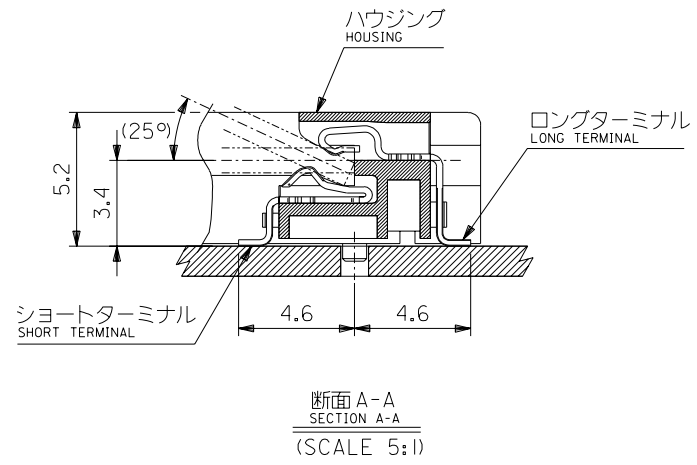
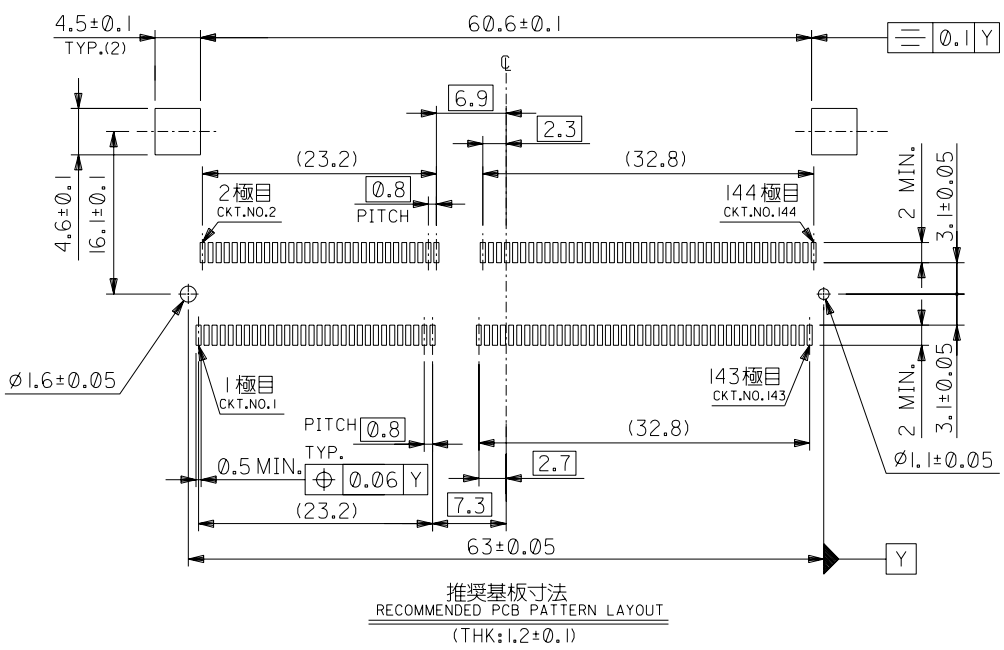

EC NO. DRWN: CHK: APPR:	EC NO. DRWN: CHK: APPR:	EC NO. DRWN: CHK: APPR:	EC NO. DRWN: CHK: APPR:	EC NO. DRWN: CHK: APPR:	EC NO. DRWN: CHK: APPR:
					0

DESCRIPTION	MATERIAL 材料	注記参照 SEE NOTES
	FINISH 仕上げ	注記参照 SEE NOTES
	WIRE RANGE 適用線径範囲	—
	INS. RANGE 被覆外径	—

GENERAL TOLERANCES: (UNLESS SPECIFIED) 一般公差	SCALE 2:1	DESIGN UNITS <input checked="" type="checkbox"/> mm <input type="checkbox"/> INCH
10 UNDER 未満	±0.2	
10 OVER 30 UNDER 以上 未満	±0.25	
30 OVER 以上	±0.3	
ANGLE 角度	±3°	

MODEL NO. 54698-700*	DIMENSIONS: <input type="checkbox"/> mm <input type="checkbox"/> INCH <input checked="" type="checkbox"/> mm ONLY	SHT	REV
THIRD ANGLE PROJECTION	TITLE: 0.8mm PITCH S.O.DIMM SOCKET 144CKT. HEIGHT 5.2mm -LEAD FREE-		
DRAWN BY & DATE M.NAGATA '04/05/14	CHECKED BY & DATE K.TOJO '04/05/14	APPROVED BY & DATE M.SASAO '04/05/14	
CAD FILENAME SD-54698-004.S02	MATERIAL NO. SEE CHART	DRAWING NO. SD-54698-004	SHEET NO. 2 OF 3
THIS DRAWING CONTAINS INFORMATION THAT IS PROPRIETARY TO MOLEX INCORPORATED AND SHOULD NOT BE USED WITHOUT WRITTEN PERMISSION.			SIZE B

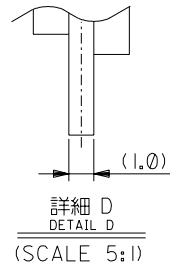
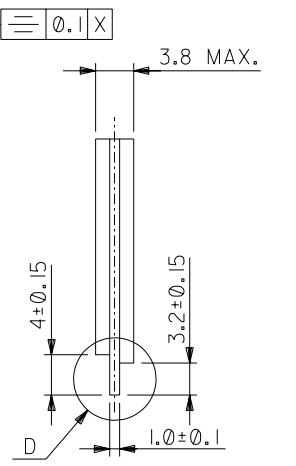
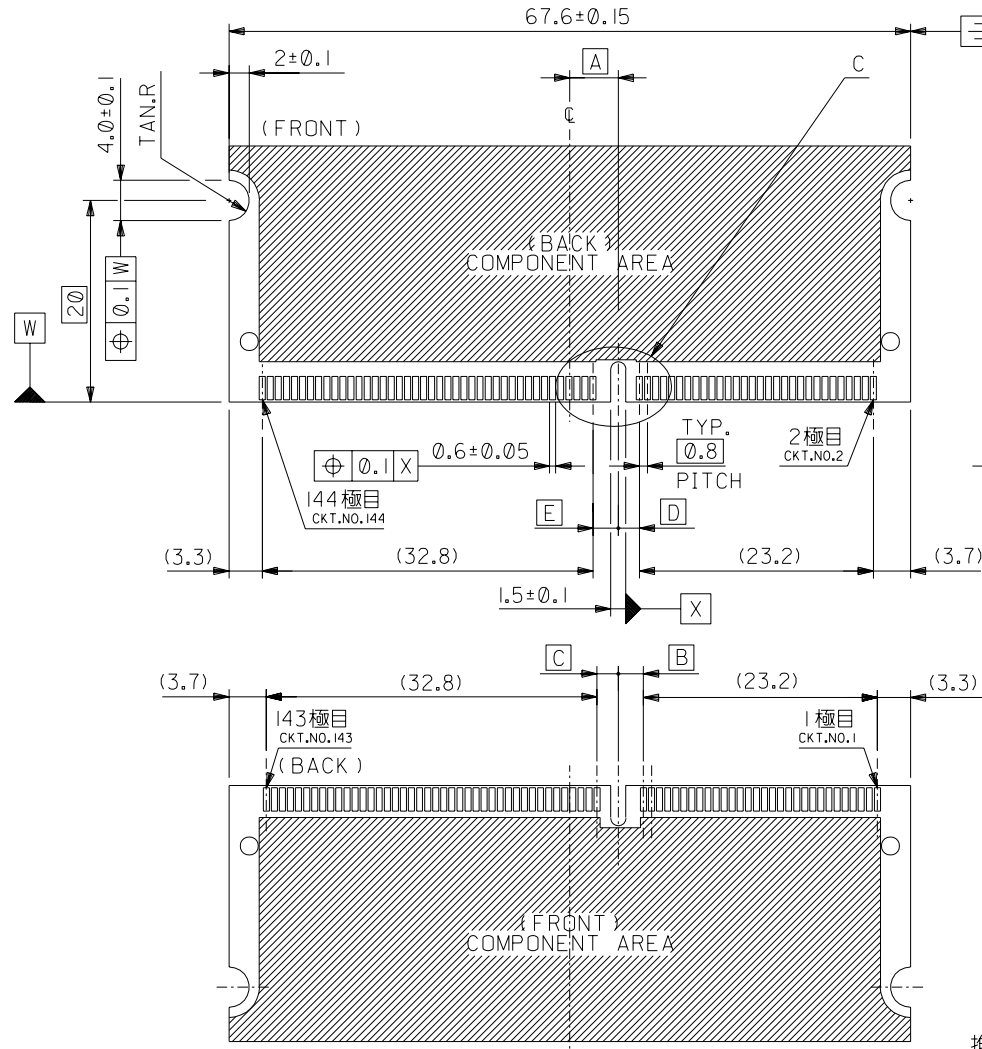

詳細 D  
DETAIL D  
(SCALE 5:1)

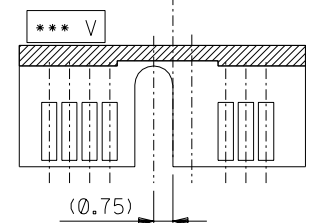
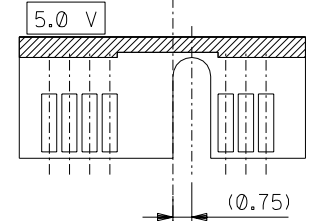
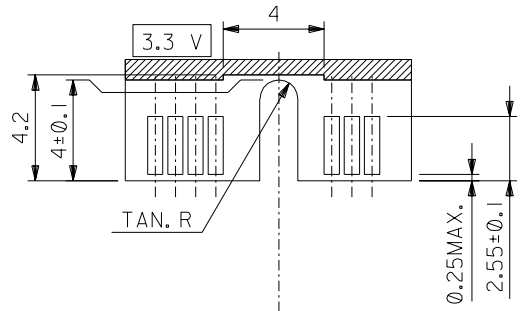

詳細 C  
DETAIL C  
(SCALE 5:1)

推奨基板寸法  
RECOMMENDED MATING BOARD CONFIGURATION  
(THK:1.0±0.1)

DO NOT SCALE DRAWING

EC NO. DRWN: CHK: APPR:	EC NO. DRWN: CHK: APPR:	EC NO. DRWN: CHK: APPR:	EC NO. DRWN: CHK: APPR:	EC NO. DRWN: CHK: APPR:	EC NO. DRWN: CHK: APPR:
0					

MATERIAL 材料	注記参照 SEE NOTES
FINISH 仕上り	注記参照 SEE NOTES
WIRE RANGE 適用電線範囲	—
INS. RANGE 被覆外径	—

GENERAL TOLERANCES: (UNLESS SPECIFIED) 一般公差	10 UNDER 未満	±0.2
	10 OVER 30 UNDER 以上 未満	±0.25
	30 OVER 以上	±0.3
ANGLE 角度		±3°

MODEL NO.	54698-700*	DIMENSIONS:	SHT	REV
DESIGN UNITS	<input checked="" type="checkbox"/> mm <input type="checkbox"/> INCH	<input type="checkbox"/> mm <input type="checkbox"/> INCH <input checked="" type="checkbox"/> mm ONLY		
SCALE	2:1	THIRD ANGLE PROJECTION		
DRAWN BY & DATE	M.NAGATA '04/05/14	TITLE:	0.8mm PITCH S.O.DIMM SOCKET 144CKT. HEIGHT 5.2mm -LEAD FREE-	
CHECKED BY & DATE	K.TOJO '04/05/14	MOLEX INCORPORATED		
APPROVED BY & DATE	M.SASAO '04/05/14	MATERIAL NO.	DRAWING NO.	SHEET NO.
CAD FILENAME	SD-54698-004.S03	SEE CHART	SD-54698-004	3 OF 3
THIS DRAWING CONTAINS INFORMATION THAT IS PROPRIETARY TO MOLEX INCORPORATED AND SHOULD NOT BE USED WITHOUT WRITTEN PERMISSION.				SIZE B