

SKiiP 13NAB065V1

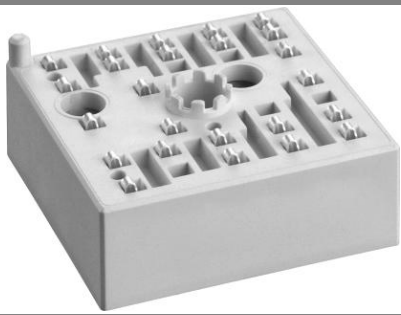

MiniSKiiP[®] 1

3-phase bridge rectifier +
brake chopper + 3-phase
bridge inverter
SKiiP 13NAB065V1

Features

- Ultrafast NPT IGBTs
- Robust and soft freewheeling diodes in CAL technology
- Highly reliable spring contacts for electrical connections
- UL recognised file no. E63532

Typical Applications

- Inverter up to 5,6 kVA
- Typical motor power 3,0 kW

Remarks

- V_{CEsat} , V_F = chip level value

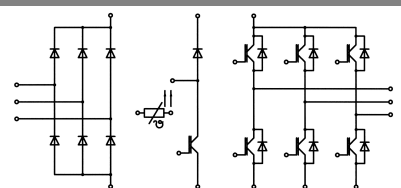

NAB

Absolute Maximum Ratings		$T_s = 25\text{ °C}$, unless otherwise specified	
Symbol	Conditions	Values	Units
IGBT - Inverter, Chopper			
V_{CES}	$T_s = 25\text{ (70) °C}$ $t_p \leq 1\text{ ms}$	600	V
I_C		24 (18)	A
I_{CRM}		30	A
V_{GES}		± 20	V
T_j		- 40 ... + 150	°C
Diode - Inverter, Chopper			
I_F	$T_s = 25\text{ (70) °C}$ $t_p \leq 1\text{ ms}$	26 (19)	A
I_{FRM}		30	A
T_j		- 40 ... + 150	°C
Diode - Rectifier			
V_{RRM}	$T_s = 70\text{ °C}$ $t_p = 10\text{ ms, sin } 180\text{ °, } T_j = 25\text{ °C}$ $t_p = 10\text{ ms, sin } 180\text{ °, } T_j = 25\text{ °C}$	800	V
I_F		35	A
I_{FSM}		220	A
i^2t		240	A ² s
T_j		- 40 ... + 150	°C
I_{tRMS}	per power terminal (20 A / spring)	20	A
T_{stg}	$T_{op} \leq T_{stg}$	- 40 ... + 125	°C
V_{isol}	AC, 1 min.	2500	V

Characteristics		$T_s = 25\text{ °C}$, unless otherwise specified			
Symbol	Conditions	min.	typ.	max.	Units
IGBT - Inverter, Chopper					
V_{CEsat}	$I_{Cnom} = 15\text{ A, } T_j = 25\text{ (125) °C}$		2 (2,2)	2,5 (2,7)	V
$V_{GE(th)}$	$V_{GE} = V_{CE}, I_C = 0,5\text{ mA}$	3	4	5	V
$V_{CE(TO)}$	$T_j = 25\text{ (125) °C}$		1,2 (1,1)	1,3 (1,2)	V
r_T	$T_j = 25\text{ (125) °C}$		53 (73)	80 (100)	mΩ
C_{ies}	$V_{CE} = 25\text{ V, } V_{GE} = 0\text{ V, } f = 1\text{ MHz}$		0,77		nF
C_{oes}	$V_{CE} = 25\text{ V, } V_{GE} = 0\text{ V, } f = 1\text{ MHz}$		0,12		nF
C_{res}	$V_{CE} = 25\text{ V, } V_{GE} = 0\text{ V, } f = 1\text{ MHz}$		0,06		nF
$R_{th(j-s)}$	per IGBT		1,4		K/W
$t_{d(on)}$	under following conditions		20		ns
t_r	$V_{CC} = 300\text{ V, } V_{GE} = \pm 15\text{ V}$		30		ns
$t_{d(off)}$	$I_{Cnom} = 15\text{ A, } T_j = 125\text{ °C}$		195		ns
t_f	$R_{Gon} = R_{Goff} = 50\text{ Ω}$		10		ns
E_{on}	inductive load		0,6		mJ
E_{off}			0,3		mJ
Diode - Inverter, Chopper					
$V_F = V_{EC}$	$I_{Fnom} = 15\text{ A, } T_j = 25\text{ (125) °C}$		1,4 (1,4)	1,7 (1,7)	V
$V_{(TO)}$	$T_j = 25\text{ (125) °C}$		1 (0,9)	1,1 (1)	V
r_T	$T_j = 25\text{ (125) °C}$		30 (33)	40 (47)	mΩ
$R_{th(j-s)}$	per diode		2,2		K/W
I_{RRM}	under following conditions		22		A
Q_{rr}	$I_{Fnom} = 15\text{ A, } V_R = 300\text{ V}$		1,5		μC
E_{rr}	$V_{GE} = 0\text{ V, } T_j = 125\text{ °C}$ $di_F/dt = 1100\text{ A/μs}$		0,4		mJ
Diode - Rectifier					
V_F	$I_{Fnom} = 15\text{ A, } T_j = 25\text{ °C}$		1,1		V
$V_{(TO)}$	$T_j = 150\text{ °C}$		0,8		V
r_T	$T_j = 150\text{ °C}$		20		mΩ
$R_{th(j-s)}$	per diode		1,5		K/W
Temperature Sensor					
R_{ts}	3 %, $T_r = 25\text{ (100) °C}$		1000(1670)		Ω
Mechanical Data					
w			35		g
M_s	Mounting torque	2		2,5	Nm

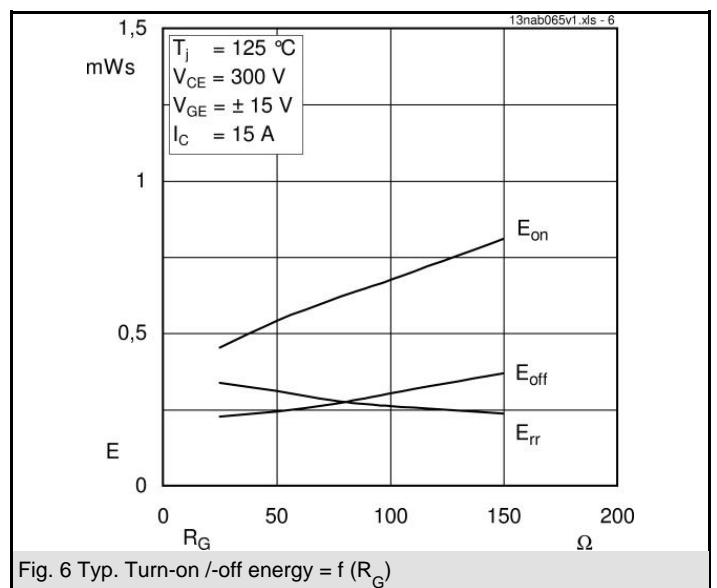
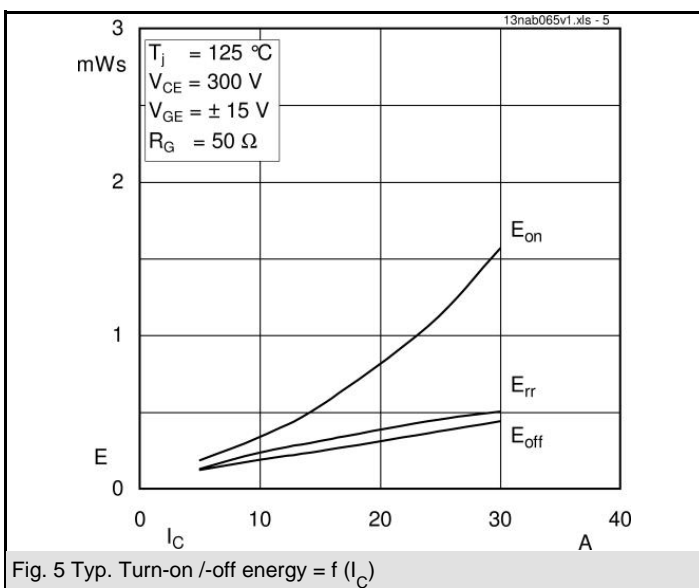
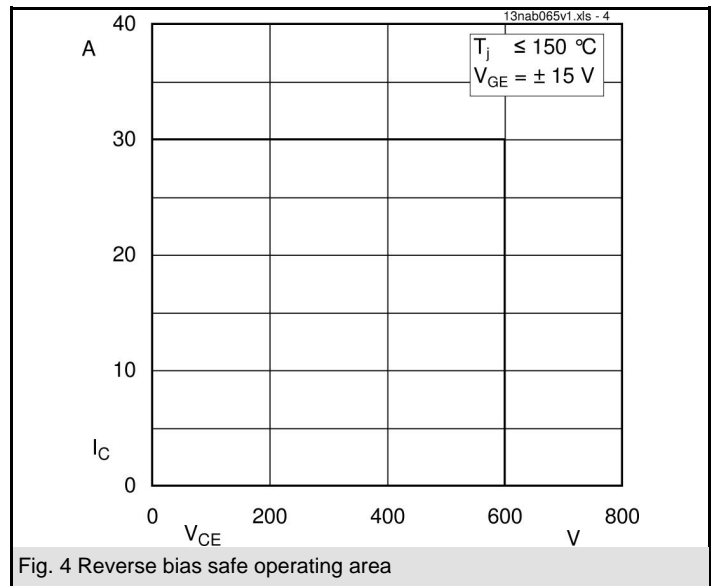
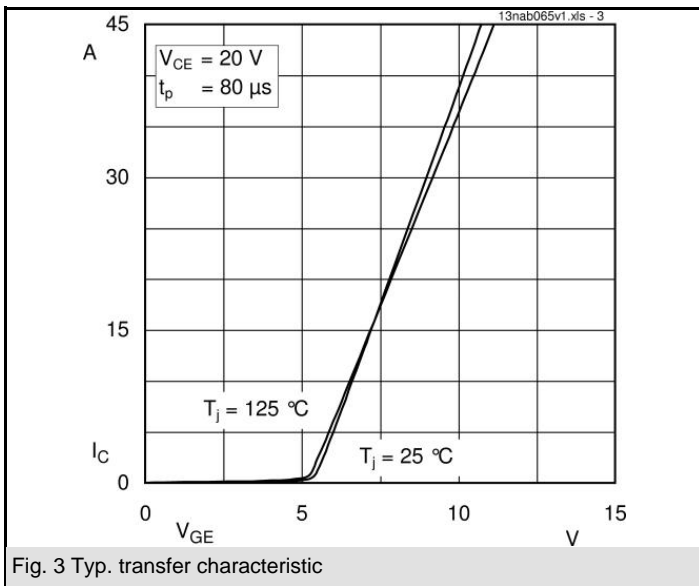
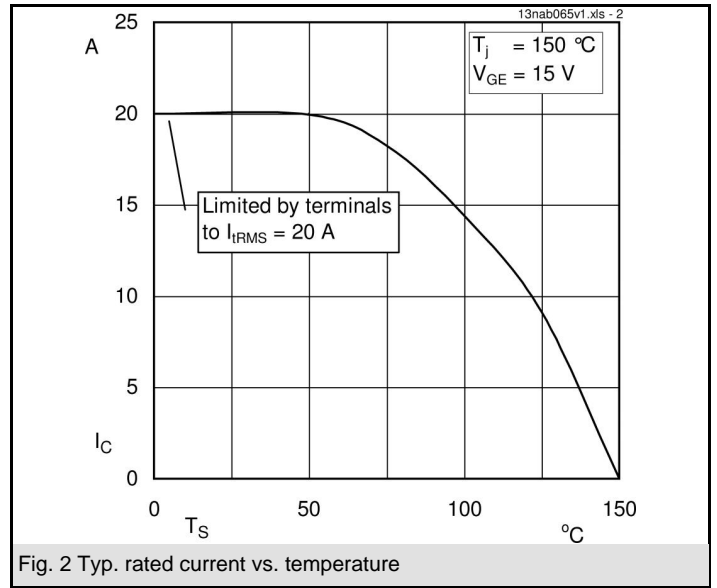
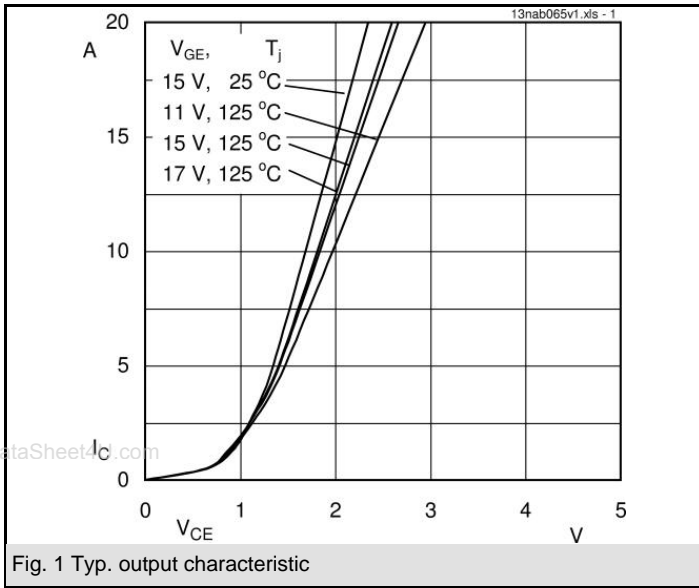

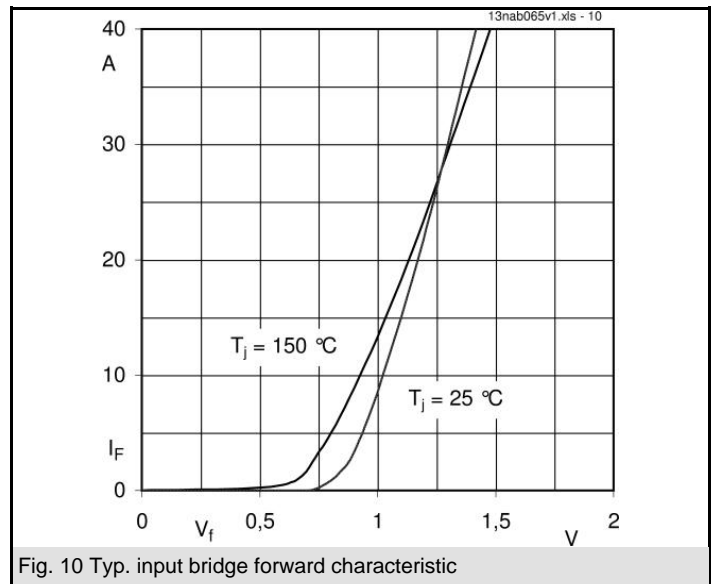
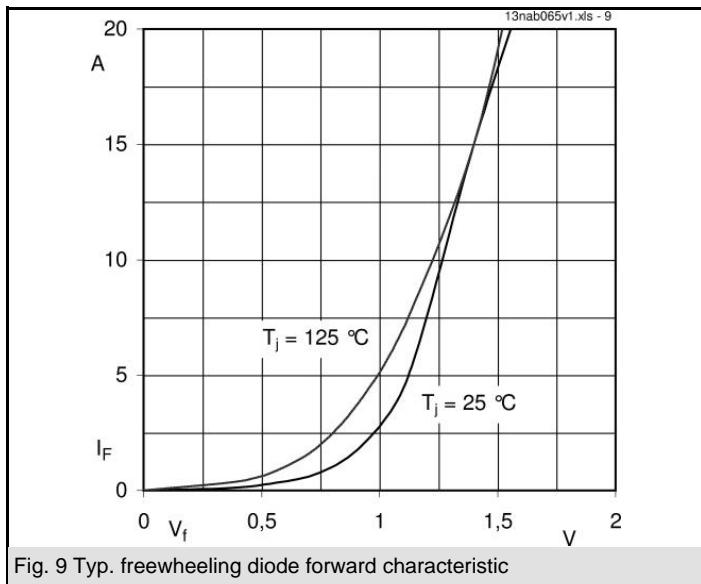
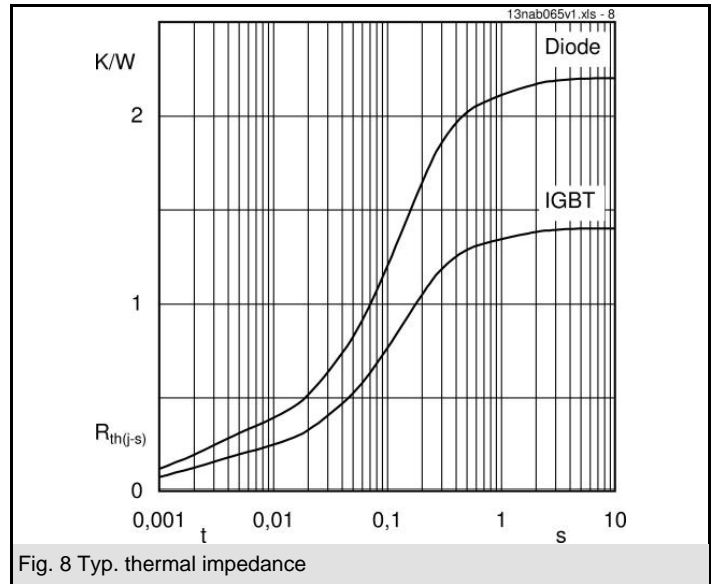
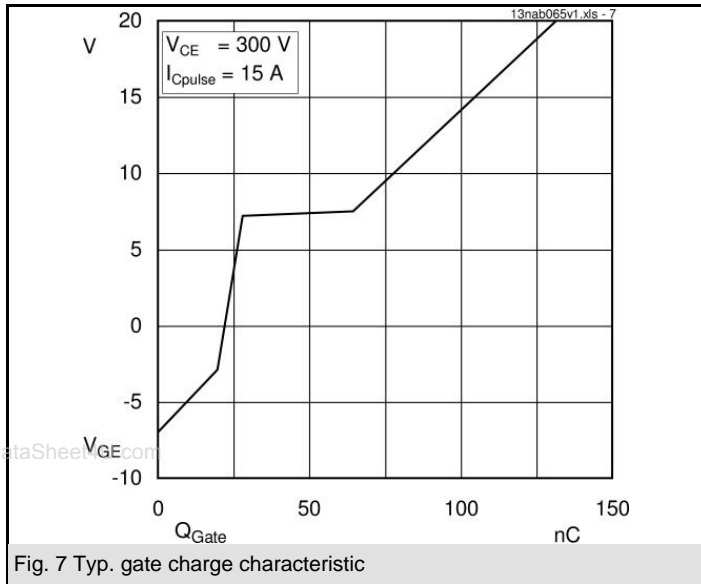

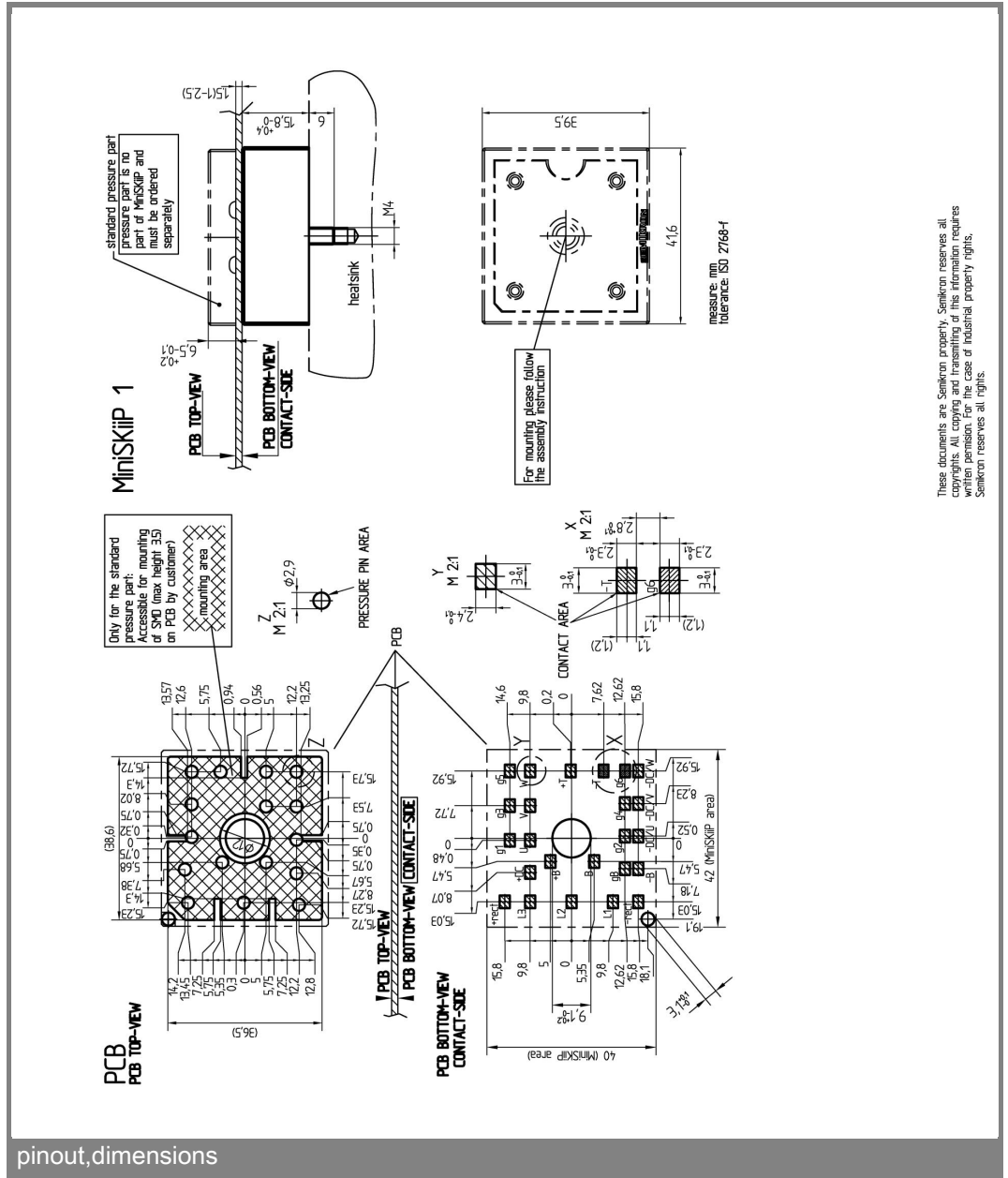
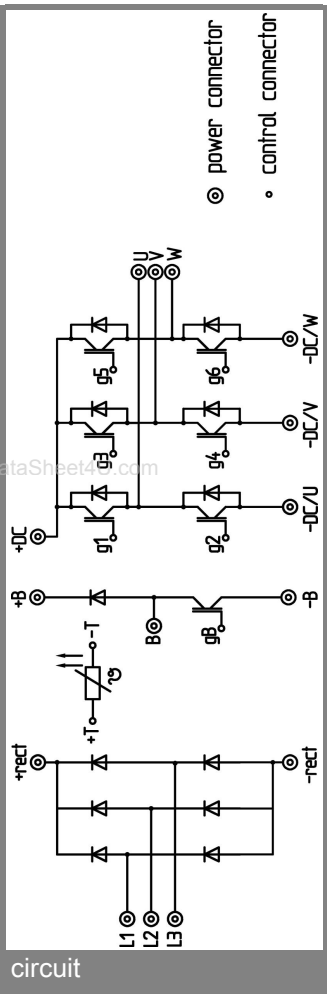

These documents are Semikron property. Semikron reserves all rights. All other rights are reserved. No warranty or guarantee is given. For the case of industrial property rights, Semikron reserves all rights.

This is an electrostatic discharge sensitive device (ESDS), international standard IEC 60747-1, Chapter IX.

This technical information specifies semiconductor devices but promises no characteristics. No warranty or guarantee expressed or implied is made regarding delivery, performance or suitability.